



## **CITY OF MIAMI SPRINGS, FLORIDA**

**Mayor Maria Puente Mitchell**

**Vice Mayor Bob Best**  
**Councilman Walter Fajet, Ph. D.**

**Councilwoman Jacky Bravo**  
**Councilman Victor Vazquez, Ph. D.**

***Decorum:** "Any person making impertinent or slanderous remarks or who becomes boisterous while addressing the City Council, shall be barred from further audience before the City Council by the Mayor, unless permission to continue or again address the City Council is granted by the majority vote of the City Council members present. In accordance with the foregoing, the City Council has determined that racial or ethnic slurs, personal attacks and comments unrelated to City matters or issues constitute prohibited comments from the podium."*

### **CITY COUNCIL REGULAR MEETING AGENDA**

**Monday, June 28, 2021 – 7:00 p.m.**

**City Hall, Council Chambers, 201 Westward Drive, Miami Springs, Florida**  
**(In-person and virtually. See pages 3-4 for additional information)**

- 1. Call to Order/Roll Call**
- 2. Invocation:** Mayor Maria Mitchell  
**Pledge of Allegiance:** Audience will lead the Pledge of Allegiance and Salute to the Flag
- 3. Agenda / Order of Business**
- 4. Awards & Presentations:**
  - A) Yard of the Month Award – July 2021 – 189 Morningside Drive – Ydelma Reyes
- 5. Open Forum:** Persons wishing to speak on items of general City business, may do so in person (*subject to capacity restrictions*) or virtually by following the instructions on pages 3-4. This portion of the meeting also includes any pre-screened video submittals. *The purpose of Open Forum is to encourage residents and members of the public to address their concerns and make comments on any item. The City Council will not enter into a dialogue at this time. City staff will gladly address any question, issue, and/or comment after the meeting. The Mayor is the presiding officer of all Council meetings and shall conduct the meetings accordingly.*
- 6. Approval of Council Minutes:**
  - A) June 14, 2021 – Regular Meeting
- 7. Reports from Boards & Commissions: None.**
- 8. Public Hearings:**
  - A) **Ordinance – Second Reading** – An Ordinance Of The City Of Miami Springs, Florida, Dissolving The Code Review Board, The Memorial Committee, And The Golf And Country Club Advisory Board By Repealing Articles III, IV, And XIV Of Chapter 32, "Boards, Commissions, Committees" Of The City's Code Of Ordinances; Providing For Conflicts; Providing For Severability; Providing For Codification; And Providing For An Effective Date

**9. Consent Agenda: (Funded and/or Budgeted):**

A) **Resolution** – A Resolution Of The Mayor And City Council Of The City Of Miami Springs, Florida, Selecting Greater Miami Caterers, Inc. For Congregate And Home Delivered Meals For The City’s Elderly Community Pursuant To Request For Proposals No. 01-20/21; Authorizing A Contract In An Amount Not To Exceed \$236,920.20 Annually; And Providing For An Effective Date

B) **Resolution** – A Resolution Of The Mayor And City Council Of The City Of Miami Springs, Florida, Approving The Purchase Of A Stationary Automated License Plate Reader And Extended Maintenance Agreement From General Sales Administration, Inc. D/B/A Major Police Supply In An Amount Not To Exceed Budgeted Funds Utilizing The Terms And Conditions Of The United States General Services Administration Cooperative Purchasing Agreement Pursuant To Section 31-11(E)(5) Of The City Code; Providing For Authorization; Providing For Implementation; And Providing For An Effective Date

**10. Old Business:**

A) Discussion of Senior Names for “Together We Can” Medley Monument

**11. New Business:**

A) **Ordinance – First Reading** – An Ordinance Of The City Of Miami Springs, Florida, Amending Chapter 32 Of The City’s Code Of Ordinances By Creating Article Xvii, “Nuisance Abatement Board,” Authorizing The Creation Of An Administrative Board With The Authority To Impose Fines And Other Noncriminal Penalties To Abate Certain Activities Declared Public Nuisances Pursuant To Section 893.138, Florida Statutes; Providing For Conflicts; Providing For Severability; Providing For Codification; And Providing For An Effective Date

B) **Resolution** – A Resolution Of The Mayor And City Council Of The City Of Miami Springs, Florida, Amending The Recreation Department Schedule Of Charges; Providing For Authorization; And Providing For An Effective Date

C) **Resolution** – A Resolution Of The Mayor And City Council Of The City Of Miami Springs, Florida, Approving The Purchase Of Cabana Covers For The City’s Aquatic Center From American Awning Services, Inc. In An Amount Not To Exceed \$14,400; Providing For Authorization; And Providing For An Effective Date

D) **Resolution** – A Resolution Of The Mayor And City Council Of The City Of Miami Springs, Florida, Approving The Purchase And Installation Of Fence Equipment From Guaranteed Fence Corp. In An Amount Not To Exceed \$21,042 For The East Side Fencing Project; Providing For Authorization; And Providing For An Effective Date

E) Consideration of the Board of Parks and Parkways Recommendations for nominating the Yard of the Month Awards for July, August, and September 2021

**12. Other Business:**

A) Discussion by Councilman Vazquez on Board Procedures and tasks

B) Request by Councilwoman Bravo to discuss crime watch and management/Chief's Report

**13. Reports & Recommendations:**

A) City Attorney

B) City Manager

C) City Council

**14. Adjourn**



## CITY OF MIAMI SPRINGS PUBLIC MEETING NOTICE

The City of Miami Springs will hold a Council meeting on:  
**Monday, June 28, 2021 at 7:00 p.m. at**  
**City Hall, Council Chambers, 201 Westward Drive, Miami Springs, Florida**  
**(Physical Meeting Location)**

The meeting agenda is available online at: <https://www.miamisprings-fl.gov/meetings>

Elected officials and City staff will participate from the physical meeting location. Members of the public may attend the meeting in person at the physical meeting location, or, alternatively, may watch or call in to the meeting by following these instructions:

### ATTEND THE MEETING IN PERSON AT THE PHYSICAL MEETING LOCATION

The meeting will be held in person at the physical meeting location stated above. Admission to the physical meeting location is on a first-come, first-serve basis and space is limited. Doors will open 30 minutes prior to the meeting start time. The City highly encourages those in attendance to wear facial coverings and abide by social distancing as recommended by the CDC.

### WATCH THE MEETING

- **Comcast/Xfinity:** Channel 77 (Meeting will not be live broadcast, but will be available for later viewing)
- **YouTube:** <https://www.youtube.com/channel/UC2at9KNnqUxZRSw1UkhdHLQ/featured>
- **From your computer/mobile device:** <https://www.miamisprings-fl.gov/meetings>

### CALL IN TO THE PUBLIC MEETING

**Dial 305-805-5151 or 305-805-5152**

*(Alternatively, you may also dial the phone numbers below to join the meeting:*  
1 (646) 558 8656, 1 (301) 715 8592, 1 (312) 626 6799, 1 (669) 900 9128, 1 (253) 215 8782,  
1 (346) 248 7799) **then input the Meeting ID: 863-9512-4146, followed by #.**  
**There is no participant ID. Press # again.**

Any person requiring special accommodations to access this proceeding is asked to advise the City at least 2 days before the proceeding by contacting the City Clerk at [cityclerk@miamisprings-fl.gov](mailto:cityclerk@miamisprings-fl.gov)

### PUBLIC COMMENTS WILL BE ACCEPTED BY THE FOLLOWING MEANS:

**EMAILED COMMENTS:** Members of the public may email their public comments to the City in advance of the meeting. Please email the City at [cityclerk@miamisprings-fl.gov](mailto:cityclerk@miamisprings-fl.gov) by 12:00 p.m. on the day of the meeting with the subject line "PUBLIC COMMENT" and the following information in the body of the email: Your Name, Address, if you are a hired Consultant or City Employee, and/or if you are engaged in Lobbying Activities and/or representing an organization. Please limit your comments to no more than 350 words. Public comments received via email may be read into the record during the public comment portion of the agenda, if any.

**IN-PERSON COMMENTS:** Members of the public may attend the meeting at the physical meeting location stated above and deliver their public comments in person during the public comment portion of the agenda.

**VIRTUAL COMMENTS:** *Public comments will also be accepted during the meeting using the virtual meeting platform as follows:*

**By telephone:** To ask to speak during the meeting, call in to the meeting using the instructions above. Please press \*9 from your telephone and you will be called on to speak during public comments and identified by the last 4-digits of your telephone number.

During the meeting, when your name or the last 4-digits of your telephone number is called, you will be unmuted and you may deliver your comments.

Please be sure to be in a quiet area to avoid unnecessary noise. Please provide the following information before

delivering your comments: Your Name, Address, if you are a hired Consultant or City Employee, and/or if you are engaged in Lobbying Activities and/or representing an organization.

A time limit may be imposed for each speaker during public comment.  
Your cooperation is appreciated in observing the time limit.

Any person making impertinent or slanderous remarks or who becomes boisterous while addressing the City Council, shall be barred from further audience before the City Council by the Mayor, unless permission to continue or again address the City Council is granted by the majority vote of the City Council members present. In accordance with the foregoing, the City Council has determined that racial or ethnic slurs, personal attacks and comments unrelated to City matters or issues constitute prohibited comments when addressing the Council during public comments.

#### **PUBLIC RECORDS**

The meeting will be recorded for later viewing and is a public record. The virtual chat, if any, will be saved and is a public record. Minutes of the meeting will be taken and will be made available.

#### **NOTICE PURSUANT TO §286.0105, FLORIDA STATUTES**

**IF A PERSON DECIDES TO APPEAL ANY DECISION MADE BY THE BOARD, AGENCY, OR COMMISSION WITH RESPECT TO ANY MATTER CONSIDERED AT THIS MEETING OR HEARING, HE OR SHE WILL NEED A RECORD OF THE PROCEEDINGS, AND FOR SUCH PURPOSE, HE OR SHE MAY NEED TO ENSURE THAT A VERBATIM RECORD OF THE PROCEEDINGS IS MADE, WHICH RECORD INCLUDES THE TESTIMONY AND EVIDENCE UPON WHICH THE APPEAL IS TO BE BASED.**

#### **AMERICANS WITH DISABILITIES ACT**

Pursuant to the provisions of the Americans with Disabilities Act, any person requiring special accommodations to participate in this proceeding is asked to advise the City at least 2 days before the proceeding by contacting the City Clerk's Office at 305-805-5006.

#### **LOBBYING ACTIVITIES**

In accordance with Section 33-01 of the City Code, adopting Section 2-11.1(s) of the Miami-Dade County Code, any person engaging in lobbying activities, as defined therein, must register at the City Clerk's Office before addressing the City Council on the agenda items or engaging in lobbying activities. Specifically, all persons, firms or corporations employed or retained by a principal who seeks to encourage the passage, defeat, or modifications of (1) ordinance, resolution, action or decision of the City Council; (2) any action, decision, recommendation of any City Board or Committee; or (3) any action, decision or recommendation of City personnel during the time period of the entire decision-making process on such action, decision or recommendation which will be heard or reviewed by the City Council, or a City Board or Committee shall register with the City before engaging in any lobbying activities on forms prepared for this purpose and shall state under oath his or her name, business address, the name and business address of each person or entity which has employed said registrant to lobby, and the specific issue on which he or she has been employed to lobby. A copy of the lobbyist registration form is available from the Office of the City Clerk and online at: <https://www.miamisprings-fl.gov/cityclerk/lobbyist-registration-form-0>.

**Have questions or need additional information?**

**Write:** [cityclerk@miamisprings-fl.gov](mailto:cityclerk@miamisprings-fl.gov)

**Call:** 305-805-5006

**Mail:** 201 Westward Drive, Miami Springs, FL 33166



# ***CERTIFICATE OF RECOGNITION***

Presented to

***Ydelma Reyes***

Of

***189 Morningside Drive***

for their home being designated as

***“YARD OF THE MONTH”  
July, 2021***

Presented this 28<sup>th</sup> day of June, 2021.

**CITY OF MIAMI SPRINGS, FLORIDA**

---

Maria Puente Mitchell  
Mayor

**ATTEST:**

---

Erika Gonzalez, MMC  
City Clerk



## **City of Miami Springs, Florida**

City Council Meeting

Regular Meeting Minutes

Monday, June 14, 2021 7:00 p.m.

City Hall Council Chambers, 201 Westward Drive, Miami Springs, Florida  
Virtual Council Meeting using Communications Media Technology Pursuant to  
Governor's Executive Order 20-69

- 1. Call to Order/Roll Call:** The meeting was called to order by the Mayor at 7:02 p.m.

Present were the following:

Mayor Maria Puente Mitchell

Vice Mayor Bob Best

Councilwoman Jacky Bravo

Councilman Walter Fajet, Ph.D.

Councilman Victor Vazquez, Ph.D.

City Manager/Finance Director William Alonso

Assistant City Manager Tammy Romero

City Clerk Erika Gonzalez-Santamaria

City Attorney Haydee Sera (via Zoom)

Planning Director Chris Heid (via Zoom)

Police Chief Armando Guzman

Recreation Director Omar Luna

- 2. Invocation:** Offered by Vice Mayor Bob Best  
**Pledge of Allegiance:** Audience led the Pledge of Allegiance and Salute to the Flag.
- 3. Agenda / Order of Business: None at this time.**
- 4. Awards & Presentations:**

A) Recognizing new Eagle Scouts Troop 334 members Joel Estevez, Angel Jariel Plana, Jack Ethan Fulton, Benet Sieg-Sintas, Victor Angel Vazquez-Hernandez; and Recognizing James Fulton III on receiving the Eagle Scouts District Award of Merit

**Eagle Scout Troop members introduced themselves and spoke of their Eagle Scout projects to the City Council. Mr. Fulton also addressed the City Council and thanked them for their support over the years.**

- 5. Open Forum:** The following members of the public addressed the City Council: Jennifer Llerena, 393 Minola Drive; Maria Perez-Castaneda, 310 Corydon Drive, and Rogelio Madan, 224 Lenape Drive.

**6. Approval of Council Minutes:**

A) May 24, 2021 – Regular Meeting

**Vice Mayor Best moved to approve the minutes of May 24, 2021 Regular Meeting. Councilman Fajet seconded the motion, which carried 5-0 on roll call vote. The vote was as follows: Vice Mayor Best, Councilwoman Bravo, Councilman Fajet, Councilman Vazquez, and Mayor Mitchell voting Yes.**

**7. Reports from Boards & Commissions: None at this time.**

**8. Public Hearings: None at this time.**

**9. Consent Agenda: (Funded and/or Budgeted):**

A) **Resolution** – A Resolution Of The Mayor And City Council Of The City Of Miami Springs, Florida, Approving The Issuance Of A Change Order To Stonehenge Construction, LLC For The Prince Field Concrete Pad Installation Project In An Amount Not To Exceed \$28,490; Providing For A Waiver Of Competitive Bidding; And Providing For An Effective Date

**Assistant City Manager Tammy Romero read the Resolution by title.**

**Vice Mayor Best moved to approve the Resolution as read. Councilman Vazquez seconded the motion, which carried 5-0 on roll call vote. The vote was as follows: Vice Mayor Best, Councilwoman Bravo, Councilman Fajet, Councilman Vazquez, and Mayor Mitchell voting Yes.**

**10. Old Business: None at this time.**

**11. New Business:**

A) **Ordinance – First Reading** – An Ordinance Of The City Of Miami Springs, Florida, Dissolving The Code Review Board, The Memorial Committee, And The Golf And Country Club Advisory Board By Repealing Articles III, IV, And XIV Of Chapter 32, “Boards, Commissions, Committees” Of The City’s Code Of Ordinances; Providing For Conflicts; Providing For Severability; Providing For Codification; And Providing For An Effective Date

**City Manager William Alonso read the Ordinance by title.**

**After some discussion, Councilman Fajet moved to approve the Ordinance on first reading. Councilwoman Bravo seconded the motion, which carried 3-2 on roll call vote. The vote was as follows: Councilwoman Bravo, Councilman Fajet, and Mayor Mitchell voting Yes; Vice Mayor Best and Councilman Vazquez voting No.**

B) **Resolution** – A Resolution Of The City Council Of The City Of Miami Springs, Florida, Establishing Rates For Collection Of Garbage, Trash And Recycling For



Residential And Commercial Customers Effective October 1, 2021; Providing For Implementation; And Providing For An Effective Date

**City Manager William Alonso read the Resolution by title.**

**Vice Mayor Best moved to approve the Resolution as read. Councilman Vazquez seconded the motion, which carried 5-0 on roll call vote. The vote was as follows: Vice Mayor Best, Councilwoman Bravo, Councilman Fajet, Councilman Vazquez, and Mayor Mitchell voting Yes.**

C) **Resolution** – A Resolution Of The City Council Of The City Of Miami Springs, Florida, Approving A Second Extension Of The Lease Agreement With Westward Partners, LLC For A Police Department Substation At 274 Westward Drive; Providing For Authorization; And Providing For An Effective Date

**Assistant City Manager Tammy Romero read the Resolution by title.**

**Councilman Vazquez moved to approve the Resolution as read. Councilwoman Bravo seconded the motion, which carried 5-0 on roll call vote. The vote was as follows: Vice Mayor Best, Councilwoman Bravo, Councilman Fajet, Councilman Vazquez, and Mayor Mitchell voting Yes.**

D) **Resolution** – A Resolution Of The Mayor And The City Council Of The City Of Miami Springs, Florida, Providing For The Third Amendment To The FY 2020-21 General Fund And Stormwater Enterprise Fund Budgets To Record FEMA Funding To Pay The Costs Of The Covid-19 Vaccination Sites And To Record The Costs Of The Oakwood/Stafford Park Stormwater Project; And Providing For An Effective Date

**City Manager William Alonso read the Resolution by title.**

**Vice Mayor Best moved to approve the Resolution as read. Councilman Vazquez seconded the motion, which carried 5-0 on roll call vote. The vote was as follows: Vice Mayor Best, Councilwoman Bravo, Councilman Fajet, Councilman Vazquez, and Mayor Mitchell voting Yes.**

E) **Resolution** – A Resolution Of The Mayor And City Council Of The City Of Miami Springs, Florida, Establishing The Business And Economic Development Task Force; Providing For Authorization; And Providing For An Effective Date

**City Manager William Alonso read the Resolution by title.**

**Councilman Vazquez moved to approve the Resolution with the following amendments; a third member will be appointed to the task force by the Mayor (with consultation of the City Manager) first meeting will take place beginning in September 2021, task force shall exist until September 2022 or until report is delivered with their recommendations, and removing “Secretary” in Section 5(d). Councilwoman Bravo seconded the motion, which carried 4-1 on roll call vote. The**

**vote was as follows: Councilwoman Bravo, Councilman Fajet, Councilman Vazquez, and Mayor Mitchell voting Yes; Vice Mayor Best voting No.**

F) **Resolution** – A Resolution Of The Mayor And City Council Of The City Of Miami Springs, Florida, Authorizing The Demolition Of The Structure Located At 4545 Nw 36th Street (Folio No.: 05-3120-030-0130) Consistent With The Order Of The Miami-Dade County Unsafe Structures Board; Selecting Demolition Masters, Inc. To Demolish The Structure And Secure The Property In An Amount Not To Exceed \$15,886; Authorizing The Negotiation And Execution Of A Demolition Contract; Authorizing The City Attorney To Initiate A Lawsuit To Foreclose The City’s Interests In The Property; Providing For Implementation; And Providing For An Effective Date

**City Manager William Alonso read the Resolution by title.**

**Councilman Fajet moved to approve the Resolution as read. Councilwoman Bravo seconded the motion, which carried 5-0 on roll call vote. The vote was as follows: Vice Mayor Best, Councilwoman Bravo, Councilman Fajet, Councilman Vazquez, and Mayor Mitchell voting Yes.**

G) Request by City Staff to discuss request by residents to close pedestrian sidewalks at five location on east side of the City

**Assistant City Manager Read the staff memo and City Manager William Alonso read the staff recommendation for the record. The following members of the public addressed the City Council: Odalis Nunez, 633 Minola Drive; Hilda Bennett, 633 LaVilla Drive; Yury Calderon, 632 Minola Drive; Rogelio Madan, 224 Lenape Drive; Francisco Fernandez.**

**City Council gave general consensus to staff to continue requesting quotes for the proposed fences at five locations bordering NW 36<sup>th</sup> Street, asking staff to inquire if a taller fence may be installed at the proposed locations, and provide an informational letter to the residents in the area about the proposed fences.**

## **12. Other Business:**

A) Request by Mayor Mitchell to discuss Governor’s approval of the 2021 State appropriations for the South Royal Poinciana project, East Drive project, and Senior Meals program

**Mayor Mitchell was very happy to announce that recently all three City requests for State appropriations was approved by the Governor recently. She thanked the State Legislators, Representative Bryan Avila, Senator Manny Diaz, Councilman Best, and the City Lobbyists for all their efforts and support during the legislative session.**

B) Update by Mayor Mitchell and City Manager Alonso on recent meetings with FDOT regarding the NW 36 Street Corridor and Iron Triangle Projects; and encouraging residents to participate in the virtual and physical FDOT Public Workshops on June 22<sup>nd</sup> and June 24<sup>th</sup>.

**Mayor Mitchell stated that Florida Department of Transportation (FDOT) reached out last October 2020 and presented to the City Council discussing the improvement of traffic flow and freight transport on NW 36<sup>th</sup> Street. She stated that she and the City Manager have expressed a no build plan to FDOT within the City. She encouraged the City Council and the residents to attend the June 22<sup>nd</sup> and June 24<sup>th</sup> public sessions and voice their opinions on the proposed projects in the area in and surrounding Miami Springs.**

C) Request by Councilman Fajet to discuss the proposed pedestrian bridge on North Royal (by the train tracks)

**Councilman Fajet stated that he is receiving calls from concerned residents about the proposed pedestrian bridge project at North Royal Poinciana to connect to the Metrorail system. He requested from the City Council and City Staff about having a discussion on the project detailing the construction of the project. The City Council conceded to conduct an informational session for the public and to give notice to those most affected in the surrounding area.**

D) Discussion on setting the date for the Millage Rate Meeting in July

**Members of the City Council conceded to have the special meeting on Thursday, July 22, 2021 at 5:01 p.m.**

### **13. Reports & Recommendations:**

A) City Attorney

**City Attorney Haydee Sera had no report at this time.**

B) City Manager

**City Manager William Alonso updated the City Council with vaccination dates. He had no further report at this time.**

C) City Council

**Vice Mayor Best stated that there is a new vaccine coming out in July. He thanked the staff for the set up for the Memorial Day event. On Saturday, he was able to present the proclamation the City prepared for Father Alfaro from Blessed Trinity. He recognized Jim Fulton and his time and dedication to the Boy Scouts and further requested funding for a project sponsored by the Boy Scouts. It was the general consensus of the City Council to allocate \$500.00 to the Boy Scouts. Councilman Best gave his deepest condolences to Jose Fuentes for the loss of his father.**

**Councilman Fajet thanked the City Manager and staff for coming up with a solution for the homes along NW 36<sup>th</sup> Street with the hotels that abut that residential area.**

**Councilman Vazquez stated that he will put some thought into coming up with some formalities to stimulate the advisory boards, but have an across the board process for them. He stated that he will not be at the July 4<sup>th</sup> parade. He appreciates the City Manager's quick proposals for issues happening in the residential neighborhoods that are along NW 36<sup>th</sup> Street.**

**Councilwoman Bravo thanked the City Manager William Alonso for always being there and answering all of the questions. She also thanked the Assistant City Manager, Tammy Romero, the City Clerk, Erika Gonzalez, and City Attorney Haydee Sera for always being available. She thanked Councilman Fajet for bringing up the pedestrian bridge issue, and thanked Councilman Vazquez and Vice Mayor Best for their input during the meetings.**

**Mayor Mitchell reminded everyone to get the message out on attending the FDOT public sessions coming up in late June, she encouraged the public to attend. She thanked Vice Mayor Best for hosting the Memorial Day event.**

**14. Adjourn**

There being no further business to be discussed the meeting was adjourned at 10:40 p.m.

*Respectfully submitted:*

---

*Erika Gonzalez-Santamaria, MMC  
City Clerk*

*Adopted by the City Council on  
This 28th day of June, 2021.*

---

*Maria Puente Mitchell, Mayor*

PURSUANT TO FLORIDA STATUTES 286.0105, THE CITY HEREBY ADVISES THE PUBLIC THAT IF A PERSON DECIDES TO APPEAL ANY DECISION MADE BY THIS COUNCIL WITH RESPECT TO ANY MATTER CONSIDERED AT ITS MEETING OR HEARING, HE OR SHE WILL NEED A RECORD OF THE PROCEEDINGS, AND THAT FOR SUCH PURPOSE, THE AFFECTED PERSON MAY NEED TO ENSURE THAT VERBATIM RECORD OF THE PROCEEDING IS MADE, WHICH RECORD INCLUDES THE TESTIMONY AND EVIDENCE UPON WHICH THE APPEAL IS TO BE BASED THIS NOTICE DOES NOT CONSTITUTE CONSENT BY THE CITY FOR THE INTRODUCTION OR ADMISSION OF OTHERWISE INADMISSIBLE OR IRRELEVANT EVIDENCE, NOR DOES IT AUTHORIZE CHALLENGES OR APPEALS NOT OTHERWISE ALLOWED BY LAW.



36 **Section 3. Conflicts.** All Sections or parts of Sections of the Code of  
37 Ordinances, all ordinances or parts of ordinances, and all Resolutions, or parts of  
38 Resolutions, in conflict with this Ordinance are repealed to the extent of such conflict.

39 **Section 4. Severability.** That the provisions of this Ordinance are declared to  
40 be severable and if any section, sentence, clause or phrase of this Ordinance shall for  
41 any reason be held to be invalid or unconstitutional, such decision shall not affect the  
42 validity of the remaining sections, sentences, clauses, and phrases of this Ordinance but  
43 they shall remain in effect, it being the legislative intent that this Ordinance shall stand  
44 notwithstanding the invalidity of any part.

45 **Section 5. Codification.** That it is the intention of the City Council and it is  
46 hereby ordained that the provisions of this Ordinance shall become and be made a part  
47 of the City Code, that the sections of this Ordinance may be renumbered or relettered to  
48 accomplish such intentions, and that the word Ordinance shall be changed to Section or  
49 other appropriate word.

50 **Section 6. Effective Date.** That this Ordinance shall become effective  
51 immediately upon adoption on second reading.

52 **PASSED ON FIRST READING** on the 14th day of June, 2021, on a motion made  
53 by Councilman Fajet and seconded by Councilwoman Bravo.

54 **PASSED AND ADOPTED ON SECOND READING** this \_\_\_\_ day of \_\_\_\_  
55 \_\_\_\_\_, 2021, on a motion made by \_\_\_\_\_ and seconded by \_\_\_\_\_. Upon  
56 being put to a roll call vote, the vote was as follows:

57 Vice Mayor Bob Best \_\_\_\_\_  
58 Councilwoman Jacky Bravo \_\_\_\_\_  
59 Councilman Dr. Walter Fajet \_\_\_\_\_  
60 Councilman Dr. Victor Vazquez \_\_\_\_\_  
61 Mayor Maria Puente Mitchell \_\_\_\_\_

62  
63  
64  
65  
66  
67

\_\_\_\_\_  
MARIA PUENTE MITCHELL  
MAYOR

68 ATTEST:  
69  
70  
71 \_\_\_\_\_  
72 ERIKA GONZALEZ, MMC  
73 CITY CLERK  
74  
75

76 APPROVED AS TO FORM AND LEGAL SUFFICIENCY  
77 FOR THE USE AND RELIANCE OF THE CITY OF MIAMI SPRINGS ONLY:  
78  
79  
80 \_\_\_\_\_  
81 WEISS SEROTA HELFMAN COLE & BIERMAN, P.L.  
82 CITY ATTORNEY



**EXHIBIT A**

83  
84 Chapter 32 - BOARDS, COMMISSIONS, COMMITTEES

85 \* \* \*

86 **ARTICLE III. - CODE REVIEW BOARD**

87 **Sec. 32-10. - Establishment.**

88 ~~There is created and established in the City a Code Review Board.~~

89 **Sec. 32-11. - Powers and duties.**

90 ~~The Code Review Board is vested with the power and authority, and charged with~~  
91 ~~the duty and responsibility, of the review and consideration of the Code of Ordinances~~  
92 ~~of the City, and to report to the City Council all recommendations for amendment.~~

93 **Sec. 32-12. - Members.**

94 ~~(A) The Code Review Board shall consist of five voting members appointed by each~~  
95 ~~member of the council including the Mayor for staggered three-year terms, and two~~  
96 ~~ex-officio members:~~

97 ~~(1) City Manager.~~

98 ~~(2) City Attorney.~~

99 ~~(B) Members shall be qualified electors of the City. Upon the expiration of a board~~  
100 ~~member's term, the City Council member making the original appointment, or that~~  
101 ~~City Council member's successor in office, shall appoint the board member to serve~~  
102 ~~during the new board term. If, for any reason, an appointment should not be made to~~  
103 ~~fill an expired term, the incumbent will continue to serve until his successor has been~~  
104 ~~appointed. No board member shall serve on any other board or commission of the~~  
105 ~~City while holding this office. No board member who shall have served three~~  
106 ~~consecutive terms of office, shall be eligible to serve an additional term of office for~~  
107 ~~two years thereafter, unless the appointment for any additional term shall be~~  
108 ~~confirmed by a majority of the council.~~

109 ~~(C) In the event of the death, removal, or resignation of a member, a successor shall~~  
110 ~~be appointed to fill the unexpired term by the council member making the original~~  
111 ~~appointment. In the event the original council member is no longer in office, his~~  
112 ~~successor shall fill the unexpired term.~~

113 ~~(D) The Code Review Board shall prescribe and adopt rules and regulations for~~  
114 ~~proceedings hereunder.~~

115 ~~(1) Meetings of the board shall be open to the public.~~

116 ~~(2) The Code Review Board shall keep minutes of its proceedings showing the vote~~  
117 ~~of each member on each question or if absent or failing to vote indicating that~~  
118 ~~fact, and shall keep records of its proceedings and other official actions, all of~~  
119 ~~which shall be immediately filed in the office of the board and shall be a public~~  
120 ~~record.~~

121 ~~Sec. 32-13. – Compensation.~~

122 ~~Members of the Code Review Board shall serve without compensation, and all~~  
123 ~~consultant or support services to be furnished to the board must be requested from and~~  
124 ~~approved by the City Council or their designee prior to the services being secured.~~

125 ~~Sec. 32-14. – Rules and procedures.~~

126 ~~The members of the Code Review Board shall follow the rules and procedures~~  
127 ~~governing all boards and agencies of the City.~~

128 ~~Sec. 32-15. – Recommendations for amendments.~~

129 ~~Any elector of the City who in good faith believes that an amendment should be~~  
130 ~~made to the Code of the City, who indicates his desires and recommendations in~~  
131 ~~writing, and files the same with the City Clerk, may appear at any regularly scheduled~~  
132 ~~public meeting of the board to be heard and give evidence concerning his~~  
133 ~~recommendations. The board shall also hear recommendations of the City Council, City~~  
134 ~~Attorney, City Manager, and the City Clerk, when presented. The board may on its own~~  
135 ~~initiative appoint individual members to investigate and make recommendations relative~~  
136 ~~to the amendment of the Code. All recommendations shall be submitted to the City~~  
137 ~~Council together with a report setting forth:~~

138 ~~(A) — The form of the amendment,~~

139 ~~(B) — The reason for the amendment, and~~

140 ~~(C) — Arguments and evidence in support of the amendment or against the adoption~~  
141 ~~of the amendment.~~

142 ~~Sec. 32-16. – Council to consider recommendations.~~

143 ~~The City Council may consider the recommendations of the Code Review Board at~~  
144 ~~any regular or special meeting, and may adopt, amend, or reject the recommendations~~  
145 ~~in the City Council's discretion. The recommendations of the Code Review Board as~~  
146 ~~contained in the report shall be made available to the public.~~

147 ~~ARTICLE IV. – MEMORIAL COMMITTEE~~

148 ~~Sec. 32-20. – Establishment and membership.~~

149 ~~There is established a memorial committee whose membership shall be composed~~  
150 ~~as follows:~~

151 ~~(A) — Beginning on January 1, 2013, each of the following shall serve for consecutive~~  
152 ~~one year terms on an annual rotating basis:~~

153 ~~(1) — Reverend or official delegate, All Angels Episcopal Church;~~

154 ~~(2) — Pastor or official delegate, Grace Lutheran Church;~~

155 ~~(3) — Pastor or official delegate, Vida Nueva Christian Ministries;~~

156 ~~(4) — Pastor or official delegate, Iglesia Bautista Sion.~~

157 ~~(B) — Chairperson — Historical Preservation Board.~~

158 ~~(C) Chairperson Board of Recreation.~~

159 ~~(D) Chairperson Board of Parks and Parkways.~~

160 ~~(E) Chairperson Zoning and Planning Board.~~

161 ~~Sec. 32-21. Duties.~~

162 ~~The memorial committee is charged with recommending to City Council appropriate~~  
163 ~~memorials for individuals, organizations, and special events, encouraging private~~  
164 ~~donations, and establishing minimum architectural and material standards for~~  
165 ~~memorials.~~

166 ~~Sec. 32-22. Rules of procedure.~~

167 ~~In the performance of these duties the memorial committee and the City Council~~  
168 ~~shall be governed by the following rules of procedure:~~

169 ~~(A) Recommendation for a memorialization for a deceased individual may be~~  
170 ~~sought only upon petition of a Miami Springs citizen or citizen group, or by~~  
171 ~~majority vote of the City Council.~~

172 ~~(B) The memorial committee shall consider all petitions and requests for~~  
173 ~~consideration from City Council vote within 60 days of transmission from the city~~  
174 ~~clerk.~~

175 ~~(C) Recommendations of the memorial committee shall be considered by the City~~  
176 ~~Council at its next regular meeting following receipt of the Board's~~  
177 ~~recommendation. Recommendations shall include estimates of annual~~  
178 ~~maintenance costs, if any. Public memorial funding may be made only during~~  
179 ~~adoption of the City's annual budget, unless the City Council specifically approves~~  
180 ~~the use of contingency account funding by a four-fifths vote.~~

181 ~~(D) All memorials established under the procedures prescribed by this section shall~~  
182 ~~stand for a minimum of ten years before a name may be removed or the memorial~~  
183 ~~dismantled by majority vote of the City Council. However, a memorial may have~~  
184 ~~a name removed or the memorial may be dismantled at any time subsequent to~~  
185 ~~a public hearing specifically called to consider the matter, and the rendering of~~  
186 ~~an affirmative four-fifths vote of the City Council for such removal or dismantling.~~  
187 ~~Renaming of existing memorials shall require conformance to the provisions of~~  
188 ~~this section.~~

189 ~~(E) The Memorial Committee shall utilize the following criteria in evaluating~~  
190 ~~eligibility for memorialization:~~

191 ~~1. That a person under consideration must be deceased.~~

192 ~~2. That a person must have resided in the City of Miami Springs.~~

193 ~~3. That a person must have contributed in some significant manner to the City.~~

194 ~~4. That a person with ties to the City must have distinguished themselves in~~  
195 ~~acts, actions or activities unrelated to the City.~~



233 ~~(B) The board shall keep minutes of its proceedings, showing the vote of each~~  
234 ~~member on each question or, if absent or failing to vote, indicating that fact. In~~  
235 ~~addition, the board shall keep records of all its proceedings and other official~~  
236 ~~actions, all of which shall be immediately filed in the City Clerk's office, and shall~~  
237 ~~be a public record.~~

238 ~~(C) Board action shall require the presence of a quorum of three board members.~~

239 ~~(D) All actions of the board shall be approved by a majority vote, except that no~~  
240 ~~less than three like votes are required if less than the entire board is voting.~~

241 ~~Sec. 32-97. - Consultant and support services.~~

242 ~~The board shall act only in an advisory capacity to the City Council, and all~~  
243 ~~consultant and support services to be furnished to the board must be requested from~~  
244 ~~and approved by the City Council prior to the services being secured. In no way can any~~  
245 ~~act of the board exceed the specific authorization and power conferred upon it by the~~  
246 ~~City Council.~~

247 ~~Sec. 32-98. - Duties and responsibilities.~~

248 ~~The duties and responsibilities of the board shall be as follows:~~

249 ~~(A) To act as an advisory board for the City Council in all matters relating to the~~  
250 ~~City golf and country club.~~

251 ~~(B) To perform all tasks, studies, or activities as may be directed by the City Council~~  
252 ~~in regard to the City golf and country club.~~

253 ~~(C) To make recommendations to the City Council in regard to the operation,~~  
254 ~~maintenance and future development of the City golf and country club.~~

255 ~~(D) To conduct meetings to solicit the ideas and opinions of the citizens in regard~~  
256 ~~to all matters relating to the City golf and country club.~~

257 ~~(E) To secure information, data, and exhibits to assist the City Council in regard to~~  
258 ~~all matters relating to the City golf and country club.~~

259 ~~(F) To provide the City Council with suggestions for new golf and country club~~  
260 ~~facilities, projects or programs.~~

261 \* \* \*



# AGENDA MEMORANDUM

**Meeting Date:** 6/28/2021

**To:** The Honorable Mayor Maria Puente Mitchell and Members of the City Council

**Via:** William Alonso, City Manager/Fin. Director

**From:** Zuzell E. Murguido, Procurement Specialist II

**Subject:** Congregate & Home-Delivered Meals for the City of Miami Springs Elderly Community  
- Award Contract

---

**RECOMMENDATION:** Recommendation by Finance- Professional Services that Council approve a Resolution (attached as Exhibit “B”) and award City RFP #01-20/21 to Greater Miami Caterers, Inc., the lowest and sole responsive-responsible bidder and authorize the execution of a contract (attached as Exhibit “C”), in the amount not to exceed \$236,920.20, for an initial (1) one year term period with the option to renew (5) four additional (1) one year term periods through 09/31/2027, for the Congregate & Home-Delivered Meals for the City of Miami Springs Elderly Community, as funds were budgeted in the 21-22 fiscal year budget pursuant to Section §31.11 (E)(1) of the City Code.

**DISCUSSION:** The city advertised a Request for Proposal (RFP) for Congregate & Home-Delivered Meals for the City of Miami Springs Elderly Community (a copy of this RFP is on file with the City Clerk’s Office) on May 17, 2021 through the Daily Business review, posted on DemandStar, as well as on the City’s web page and on the City’s message board located in the lobby. The City received one response from Greater Miami Caterers, Inc., (proposal attached as Exhibit “A”) in the amount of \$236,920.20. The response was evaluated by Zuzell Murguido, Procurement Specialist II, in accordance with the evaluation criteria set forth in the RFP, including the bidder’s qualifications/experience, references, and cost. A copy of the bid tabulation and ranking sheet are attached.

Greater Miami Caterers, Inc.’s proposal of \$236,920.20 includes congregare meals, home delivered weekday meals, and home delivered weekend meals. The cost of these meals are paid utilizing Older Americans Act (OAA) Program, Local Services Program (LSP) funds, and City funds. Currently, the Miami Springs Adult Community Center is not serving in person meals at this time, until further notice. Last month, the total meals served were as follows: 1,587 home delivered breakfast meals, 1,073 home delivered weekday lunches, 514 home delivered weekend lunches and for the individuals that normally come in to receive congregare meals, we have been delivering 3,596 frozen lunch meals.

**COST:** As per the attached correspondence from John Olmo, Vice-President (attachment #2), Greater Miami Caterers proposed pricing for congregare meals and home delivered meals are as follows:

- a unit cost of **\$3.80** per each Congregate Meals;
- a unit cost of **\$5.06** per each Home Delivered Weekday Meals;
- a unit cost of **\$4.62** per each Home Delivered Weekend Meals;
- a unit cost of **\$4.16** per each Home Delivered Breakfast Meals;
- a unit cost of **\$7.36** per each Home Delivered Emergency Shelf Stable Meals;
- a unit cost of **\$6.80** per each Congregate Delivered Emergency Shelf Stable Meals; and
- a unit cost of **\$5.03** per each C1 Covid-19 Related Frozen Congregate Meals.

Greater Miami Caterers, Inc. has provided these services to the City for the past (11) years. The City has been satisfied with Greater Miami Caterers, Inc.'s service and the residents who receive these services are also satisfied.

A Participant Satisfaction Survey is administered to the congregate meal recipients in November of every year. The percentage of 98 respondents who rated the meals to be either "excellent" or "good" was as follows: overall quality of food service: 40% of the respondents indicate "excellent", 50% indicate "good", 10% indicate "fair". Temperature of the food at serving time: 45% of the respondents indicate "excellent", 55% indicate "good". The overall taste of the food served: 33% of the respondents indicate "excellent", 52% indicate "good", 15% indicate "fair".

The City has reviewed comparable meals costs paid by other nutrition programs for the elderly throughout Miami-Dade County and finds that the price proposed by Greater Miami Caterers, Inc. is appropriate and in the City's best interest.

Staff recommends that Council select Greater Miami Caterers, Inc. pursuant to the RFP and authorize the City Manager to negotiate and execute a contract with Greater Miami Caterers, Inc. for a one year term beginning October 1, 2021 and ending September 30, 2022, with up to five additional one year option years through September 30, 2027, in an amount not to exceed \$236,920.20 annually.

**FUNDING: Department/ Description: Elderly Services**

- Account Numbers:**
- 1) 140-5101-519.52-04
  - 2) 140-5102-519.52-04
  - 3) 140-5102-519.52-21
  - 4) 140-5104-519-52-40
  - 5) 140-5104-519-52-41
  - 6) 140-5104-519-52-24
  - 7) 140-5104-519-52-25

**Grant Source and Contract Number:** Older Americans Act Title III grants (Contract #AA-1605 and #AA-1705) and the Nutrition Services Incentive Program (Contract #US-1645 and #US-1655). *\*the City funds the cost of Home Delivered Weekend Meals for the seniors residing in Miami Springs.*

On June 2, 2021 the Governor signed the state budget for the 2021-2022 fiscal year and the Miami Springs Adult Community Center will receive \$215,000 dollars for one year, in state appropriations that will be applied towards the Miami Springs Senior Center meals and programs.

**FISCAL IMPACT:** Funding will come from the budgeted Senior Center OAA funds, LSP funds and City funds.

**Submission Date and Time:** 6/23/2021 12:51 PM

<u>Submitted by:</u>	<u>Approved by (sign as applicable):</u>	<u>Funding:</u>
<b>Department:</b> <u>Finance</u> <b>Prepared by:</b> <u>Zuzell Murguido</u> <b>Attachments:</b> <input checked="" type="checkbox"/> Yes <input type="checkbox"/> No <b>Budgeted/ Funded:</b> <input checked="" type="checkbox"/> Yes <input type="checkbox"/> No	<b>Dept. Head:</b> _____ <b>Procurement:</b> _____ <b>Asst. City Mgr.:</b> _____ <b>City Manager:</b> _____	<b>Dept./ Desc.:</b> _____ <b>Account No.:</b> _____ <b>Additional Funding:</b> _____ <b>Amount previously approved:</b> \$ _____ <b>Current request:</b> \$ <u>236,920.20</u> <b>Total vendor amount:</b> \$ <u>236,920.20</u>

RESOLUTION NO. 2021-\_\_\_\_

**A RESOLUTION OF THE MAYOR AND CITY COUNCIL OF THE CITY OF MIAMI SPRINGS, FLORIDA, SELECTING GREATER MIAMI CATERERS, INC. FOR CONGREGATE AND HOME DELIVERED MEALS FOR THE CITY'S ELDERLY COMMUNITY PURSUANT TO REQUEST FOR PROPOSALS NO. 01-20/21; AUTHORIZING A CONTRACT IN AN AMOUNT NOT TO EXCEED \$236,920.20 ANNUALLY; AND PROVIDING FOR AN EFFECTIVE DATE.**

**WHEREAS**, the City of Miami Springs (the "City") issued Request for Proposals No. 01-20/21 (the "RFP") for congregate and home delivered meals for the City's elderly community (the "Services"); and

**WHEREAS**, the RFP was advertised in the *Daily Business Review*, posted on DemandStar, as well as on the City's website and City lobby; and

**WHEREAS**, one sealed bid was received by the RFP deadline; and

**WHEREAS**, Greater Miami Caterers, Inc. (the "Contractor") was the lowest, most responsive and responsible bidder, with a bid submittal totaling \$236,920.20 annually; and

**WHEREAS**, pursuant to the RFP competitive selection process and the recommendation of the City Manager, the City Council desires to select the Contractor to perform the Services and authorize the City Manager to negotiate and execute a Contract with the Contractor in an amount not to exceed \$236,920.20 annually, in substantially the form attached hereto as Exhibit "A"; and

**WHEREAS**, the City Council finds that this Resolution is in the best interest and welfare of the residents of the City.

**NOW, THEREFORE, BE IT RESOLVED BY THE MAYOR AND CITY COUNCIL OF THE CITY OF MIAMI SPRINGS, FLORIDA, AS FOLLOWS:**

**Section 1. Recitals.** That the above recitals are confirmed, adopted, and incorporated herein and made a part hereof by reference.

**Section 2. Selection.** That the City Council hereby selects the Contractor to perform the Services pursuant to the RFP.



**Section 3. Authorization.** That the City Council hereby authorizes the City Manager to negotiate and execute the Contract with the Contractor in an amount not to exceed \$236,920.20 annually, in substantially the form attached hereto as Exhibit "A," subject to approval by the City Attorney as to form, content, and legal sufficiency.

**Section 4. Effective Date.** That this Resolution shall be effective immediately upon adoption.

The foregoing Resolution was offered by \_\_\_\_\_ who moved its adoption. The motion was seconded by \_\_\_\_\_ and upon being put to a vote, the vote was as follows:

Vice Mayor Bob Best	_____
Councilwoman Jacky Bravo	_____
Councilwoman Dr. Walter Fajet	_____
Councilman Dr. Victor Vazquez	_____
Mayor Maria Puente Mitchell	_____

PASSED AND ADOPTED this 28<sup>th</sup> day of June, 2021.

\_\_\_\_\_  
MARIA PUENTE MITCHELL  
MAYOR

ATTEST:

\_\_\_\_\_  
ERIKA GONZALEZ, MMC  
CITY CLERK

APPROVED AS TO FORM AND LEGAL SUFFICIENCY  
FOR THE USE AND RELIANCE OF THE CITY OF MIAMI SPRINGS ONLY:

\_\_\_\_\_  
WEISS SEROTA HELFMAN COLE & BIERMAN, P.L.  
CITY ATTORNEY

**AGREEMENT**  
**BETWEEN**  
**THE CITY OF MIAMI SPRINGS**  
**AND**  
**GREATER MIAMI CATERERS, INC.**

**THIS AGREEMENT** (this “Agreement”) is made effective as of the 1<sup>st</sup> day of October, 2021 (the “Effective Date”), by and between the **CITY OF MIAMI SPRINGS, FLORIDA**, a Florida municipal corporation, (the “City”), and **GREATER MIAMI CATERERS, INC.**, a Florida Corporation (hereinafter, the “Contractor”).

**WHEREAS**, on May 17, 2021, the City issued Request for Proposals No. 01-20/21 (“RFP”) for **CONGREGATE & HOME-DELIVERED MEALS FOR THE CITY OF MIAMI SPRINGS ELDERLY COMMUNITY**, which RFP is incorporated herein by reference; and

**WHEREAS**, the services needed by the City are specifically identified in Section 2 of the RFP (the “Services”), which Section 2 of the RFP is incorporated herein and attached hereto as Exhibit “A”; and

**WHEREAS**, in response to the RFP, the Contractor submitted a Proposal dated June 8, 2021 for the Services, which Proposal is incorporated herein by reference (the “Proposal”); and

**WHEREAS**, on June 28, 2021, the City Council adopted Resolution No. **[INSERT NUMBER]**, selecting the Contractor to provide the Services and approving an agreement with the Contractor; and

**WHEREAS**, the Contractor will perform the Services for the City, as further described in Contractor’s Proposal; and

**WHEREAS**, the Contractor and the City, through mutual negotiation, have agreed upon the compensation schedule set forth in the Price Proposal (Form 12 of the RFP) attached hereto as Exhibit “B” (the “Fee Schedule”) for the Services; and

**WHEREAS**, the City desires to engage the Contractor to perform the Services and provide the deliverables as specified below.

**NOW, THEREFORE**, in consideration of the mutual covenants and conditions contained herein, the Contractor and the City agree as follows:

**1. Scope of Services.**

- 1.1. Contractor shall provide the Services set forth in Exhibit "A" incorporated herein by reference (the "Services").
- 1.2. Contractor shall furnish all reports, documents, and information obtained pursuant to this Agreement, and recommendations during the term of this Agreement (hereinafter "Deliverables") to the City.
- 1.3. The Contractor shall abide by the terms and requirements of the RFP, as though fully set forth herein.

**2. Term/Commencement Date.**

- 2.1. The term of this Agreement shall be from the Effective Date through one (1) year thereafter, unless earlier terminated in accordance with Paragraph 8. Additionally, the City Manager may renew this Agreement for up to five (5) additional one (1) year periods on the same terms as set forth herein upon written notice to the Contractor .
- 2.2. Contractor agrees that time is of the essence and Contractor shall complete the Services within the term of this Agreement, unless extended by the City Manager.

**3. Compensation and Payment.**

- 3.1. Compensation for Services provided by Contractor shall be in accordance with the Fee Schedule attached hereto as Exhibit "C" (the "Fee Schedule"). Additional expenses that are not included in the Fee Schedule must be pre-approved, in writing by the City and will be considered as line item reimbursements, without markup. The total annual compensation for the Services shall not exceed \$236,920.20 for the term of this Agreement.
- 3.2. Contractor shall deliver an invoice to the City no more often than once per month detailing Services completed and the amount due to Contractor under this Agreement. Contractor's invoices shall be delivered in accordance with Attachment D of the RFP. Fees shall be paid in arrears each month, pursuant to Contractor's invoice, which shall be based upon the percentage of work completed for each task invoiced. The City shall pay the Contractor in accordance with the Florida Prompt Payment Act after approval and acceptance of the Services by the City Manager.
- 3.3. The City is exempt from sales tax. Accordingly, Contractor shall not collect sales tax from the City. The City shall provide a copy of its tax exempt certificate upon request.

**4. Subcontractors.**

- 4.1. The Contractor shall be responsible for all payments to any subcontractors and shall maintain responsibility for all work related to the Services and/or any Project.

4.2. Contractor may only utilize the services of a particular subcontractor with the prior written approval of the City Manager, which approval may be granted or withheld in the City Manager's sole and absolute discretion.

5. **City's Responsibilities.**

5.1. City shall make available any maps, plans, existing studies, reports, staff and representatives, and other data pertinent to the Services and in possession of the City, and provide criteria requested by Contractor to assist Contractor in performing the Services.

5.2. Upon Contractor's request, City shall reasonably cooperate in arranging access to public information that may be required for Contractor to perform the Services.

6. **Contractor's Responsibilities; Representations and Warranties.**

6.1. The Contractor shall exercise the same degree of care, skill and diligence in the performance of the Services for each Project as is ordinarily provided by a Contractor under similar circumstances. If at any time during the term of this Agreement or within two (2) years from the completion of this Agreement, it is determined that the Contractor's Deliverables or Services are incorrect, not properly rendered, defective, or fail to conform to City requests, the Contractor shall at Contractor's sole expense, immediately correct its Deliverables or Services.

6.2. The Contractor hereby warrants and represents that at all times during the term of this Agreement it shall maintain in good standing all required licenses, certifications and permits required under Federal, State and local laws applicable to and necessary to perform the Services for City as an independent contractor of the City. Contractor further warrants and represents that it has the required knowledge, expertise, and experience to perform the Services and carry out its obligations under this Agreement in a professional and first class manner.

6.3. The Contractor represents that is an entity validly existing and in good standing under the laws of Florida. The execution, delivery and performance of this Agreement by Contractor have been duly authorized, and this Agreement is binding on Contractor and enforceable against Contractor in accordance with its terms. No consent of any other person or entity to such execution, delivery and performance is required.

7. **Conflict of Interest.**

7.1. To avoid any conflict of interest or any appearance thereof, Contractor shall not, for the term of this Agreement, provide any consulting services to any private sector entities (developers, corporations, real estate investors, etc.), with any current, or foreseeable, adversarial issues in the City.

## **8. Termination.**

- 8.1.** The City Manager, without cause, may terminate this Agreement upon five (5) calendar days' written notice to the Contractor, or immediately with cause.
- 8.2.** Upon receipt of the City's written notice of termination, Contractor shall immediately stop work on the project unless directed otherwise by the City Manager.
- 8.3.** In the event of termination by the City, the Contractor shall be paid for all work accepted by the City Manager up to the date of termination, provided that the Contractor has first complied with the provisions of Paragraph 8.4.
- 8.4.** The Contractor shall transfer all books, records, reports, working drafts, documents, maps, and data pertaining to the Services and the project to the City, in a hard copy and electronic format within fourteen (14) days from the date of the written notice of termination or the date of expiration of this Agreement.

## **9. Insurance.**

- 9.1.** Contractor shall secure and maintain throughout the duration of this agreement insurance of such types and in such amounts not less than those specified below as satisfactory to City, naming the City as an Additional Insured, underwritten by a firm rated A-X or better by A.M. Best and qualified to do business in the State of Florida. The insurance coverage shall be primary insurance with respect to the City, its officials, employees, agents, and volunteers naming the City as additional insured. Any insurance maintained by the City shall be in excess of the Contractor's insurance and shall not contribute to the Contractor's insurance. The insurance coverages shall include at a minimum the amounts set forth in this section and may be increased by the City as it deems necessary or prudent.
  - 9.1.1.** Commercial General Liability coverage with limits of liability of not less than a \$1,000,000 per Occurrence combined single limit for Bodily Injury and Property Damage. This Liability Insurance shall also include Completed Operations and Product Liability coverages and eliminate the exclusion with respect to property under the care, custody and control of Contractor. The General Aggregate Liability limit and the Products/Completed Operations Liability Aggregate limit shall be in the amount of \$2,000,000 each.
  - 9.1.2.** Workers Compensation and Employer's Liability insurance, to apply for all employees for statutory limits as required by applicable State and Federal laws. The policy(ies) must include Employer's Liability with minimum limits of \$1,000,000.00 each accident. No employee, subcontractor or agent of the Contractor shall be allowed to provide Services pursuant to this Agreement who is not covered by Worker's Compensation insurance.

9.1.3. Business Automobile Liability with minimum limits of \$1,000,000 per occurrence, combined single limit for Bodily Injury and Property Damage. Coverage must be afforded on a form no more restrictive than the latest edition of the Business Automobile Liability policy, without restrictive endorsements, as filed by the Insurance Service Office, and must include Owned, Hired, and Non-Owned Vehicles.

**9.2. Certificate of Insurance.** Certificates of Insurance shall be provided to the City, reflecting the City as an Additional Insured (except with respect to Professional Liability Insurance and Worker's Compensation Insurance), no later than ten (10) days after award of this Agreement and prior to the execution of this Agreement by City and prior to commencing Services. Each certificate shall include no less than (30) thirty-day advance written notice to City prior to cancellation, termination, or material alteration of said policies or insurance. The Contractor shall be responsible for assuring that the insurance certificates required by this Section remain in full force and effect for the duration of this Agreement, including any extensions or renewals that may be granted by the City. The Certificates of Insurance shall not only name the types of policy(ies) provided, but also shall refer specifically to this Agreement and shall state that such insurance is as required by this Agreement. The City reserves the right to inspect and return a certified copy of such policies, upon written request by the City. If a policy is due to expire prior to the completion of the Services, renewal Certificates of Insurance shall be furnished thirty (30) calendar days prior to the date of their policy expiration. Each policy certificate shall be endorsed with a provision that not less than thirty (30) calendar days' written notice shall be provided to the City before any policy or coverage is cancelled or restricted. Acceptance of the Certificate(s) is subject to approval of the City.

**9.3. Additional Insured.** Except with respect to Professional Liability Insurance and Worker's Compensation Insurance, the City is to be specifically included as an Additional Insured for the liability of the City resulting from Services performed by or on behalf of the Contractor in performance of this Agreement. The Contractor's insurance, including that applicable to the City as an Additional Insured, shall apply on a primary basis and any other insurance maintained by the City shall be in excess of and shall not contribute to the Contractor's insurance. The Contractor's insurance shall contain a severability of interest provision providing that, except with respect to the total limits of liability, the insurance shall apply to each Insured or Additional Insured (for applicable policies) in the same manner as if separate policies had been issued to each.

**9.4. Deductibles.** All deductibles or self-insured retentions must be declared to and be reasonably approved by the City. The Contractor shall be responsible for the payment of any deductible or self-insured retentions in the event of any claim.

**9.5.** The provisions of this section shall survive termination of this Agreement.

**10. Nondiscrimination.** During the term of this Agreement, Contractor shall not discriminate against any of its employees or applicants for employment because of their race, color,

religion, sex, or national origin, and will abide by all Federal and State laws regarding nondiscrimination.

**11. Attorneys Fees and Waiver of Jury Trial.**

**11.1.** In the event of any litigation arising out of this Agreement, the prevailing party shall be entitled to recover its attorneys' fees and costs, including the fees and expenses of any paralegals, law clerks and legal assistants, and including fees and expenses charged for representation at both the trial and appellate levels.

**11.2.** IN THE EVENT OF ANY LITIGATION ARISING OUT OF THIS AGREEMENT, EACH PARTY HEREBY KNOWINGLY, IRREVOCABLY, VOLUNTARILY AND INTENTIONALLY WAIVES ITS RIGHT TO TRIAL BY JURY.

**12. Indemnification.**

**12.1.** Contractor shall indemnify and hold harmless the City, its officers, agents and employees, the Alliance for Aging, and the Florida Department of Elder Affairs from and against any and all demands, claims, losses, suits, liabilities, causes of action, judgment or damages, arising from Contractor's performance or non-performance of any provision of this Agreement, including, but not limited to, liabilities arising from contracts between the Contractor and third parties made pursuant to this Agreement. Contractor shall reimburse the City for all its expenses including reasonable attorneys' fees and costs incurred in and about the defense of any such claim or investigation and for any judgment or damages arising from Contractor's performance or non-performance of this Agreement.

**12.2.** Nothing herein is intended to serve as a waiver of sovereign immunity by the City nor shall anything included herein be construed as consent to be sued by third parties in any matter arising out of this Agreement or any other contract. The City is subject to section 768.28, Florida Statutes, as may be amended from time to time.

**12.3.** The provisions of this section shall survive termination of this Agreement.

**13. Patents and Royalties.** The Contractor shall pay all royalties and assume all costs arising from the use of any invention, design, process materials, equipment, product or device which is the subject of patent rights or copyrights. Contractor shall, at its own expense, hold harmless and defend the City against any claim, suit or proceeding brought against the City which is based upon a claim, whether rightful or otherwise, that the goods or services, or any part thereof, furnished under the contract, constitute an infringement of any patent or copyright of the United States. The Contractor shall pay all damages and costs awarded against the City in such matter.

**14. Notices/Authorized Representatives.** Any notices required by this Agreement shall be in writing and shall be deemed to have been properly given if transmitted by hand-delivery, by

registered or certified mail with postage prepaid return receipt requested, or by a private postal service, addressed to the parties (or their successors) at the addresses listed on the signature page of this Agreement or such other address as the party may have designated by proper notice.

**15. Governing Law and Venue.** This Agreement shall be construed in accordance with and governed by the laws of the State of Florida. Venue for any proceedings arising out of this Agreement shall be proper exclusively in Miami-Dade County, Florida.

**16. Entire Agreement/Modification/Amendment.**

**16.1.** This writing contains the entire Agreement of the parties and supersedes any prior oral or written representations. No representations were made or relied upon by either party, other than those that are expressly set forth herein.

**16.2.** No agent, employee, or other representative of either party is empowered to modify or amend the terms of this Agreement, unless executed with the same formality as this document.

**17. Ownership and Access to Records and Audits.**

**17.1.** Contractor acknowledges that all inventions, innovations, improvements, developments, methods, designs, analyses, drawings, reports, compiled information, and all similar or related information (whether patentable or not) which relate to Services to the City which are conceived, developed or made by Contractor during the term of this Agreement (“Work Product”) belong to the City. Contractor shall promptly disclose such Work Product to the City and perform all actions reasonably requested by the City (whether during or after the term of this Agreement) to establish and confirm such ownership (including, without limitation, assignments, powers of attorney and other instruments).

**17.2.** Contractor agrees to keep and maintain public records in Contractor’s possession or control in connection with Contractor’s performance under this Agreement. The City Manager or her designee shall, during the term of this Agreement and for a period of three (3) years from the date of termination of this Agreement, have access to and the right to examine and audit any records of the Contractor involving transactions related to this Agreement. Contractor additionally agrees to comply specifically with the provisions of Section 119.0701, Florida Statutes. Contractor shall ensure that public records that are exempt or confidential and exempt from public records disclosure requirements are not disclosed, except as authorized by law, for the duration of the Agreement, and following completion of the Agreement until the records are transferred to the City.

**17.3.** Upon request from the City’s custodian of public records, Contractor shall provide the City with a copy of the requested records or allow the records to be inspected or



copied within a reasonable time at a cost that does not exceed the cost provided by Chapter 119, Florida Statutes, or as otherwise provided by law.

**17.4.** Unless otherwise provided by law, any and all records, including but not limited to reports, surveys, and other data and documents provided or created in connection with this Agreement are and shall remain the property of the City.

**17.5.** Upon completion of this Agreement or in the event of termination by either party, any and all public records relating to the Agreement in the possession of the Contractor shall be delivered by the Contractor to the City Manager, at no cost to the City, within seven (7) days. All such records stored electronically by Contractor shall be delivered to the City in a format that is compatible with the City's information technology systems. Once the public records have been delivered upon completion or termination of this Agreement, the Contractor shall destroy any and all duplicate public records that are exempt or confidential and exempt from public records disclosure requirements.

**17.6.** Any compensation due to Contractor shall be withheld until all records are received as provided herein.

**17.7.** Contractor's failure or refusal to comply with the provisions of this section shall result in the immediate termination of this Agreement by the City.

**17.8. Notice Pursuant to Section 119.0701(2)(a), Florida Statutes. IF THE CONTRACTOR HAS QUESTIONS REGARDING THE APPLICATION OF CHAPTER 119, FLORIDA STATUTES, TO THE CONTRACTOR'S DUTY TO PROVIDE PUBLIC RECORDS RELATING TO THIS AGREEMENT, CONTACT THE CUSTODIAN OF PUBLIC RECORDS: ERIKA GONZALEZ, MMC, 201 WESTWARD DRIVE, MIAMI SPRINGS, FL 33166, 305-805-5006, GONZALEZE@MIAMISPRINGS-FL.GOV.**

**18. Nonassignability.** This Agreement shall not be assignable by Contractor unless such assignment is first approved by the City Manager. The City is relying upon the apparent qualifications and expertise of the Contractor, and such firm's familiarity with the City's area, circumstances and desires.

**19. Severability.** If any term or provision of this Agreement shall to any extent be held invalid or unenforceable, the remainder of this Agreement shall not be affected thereby, and each remaining term and provision of this Agreement shall be valid and be enforceable to the fullest extent permitted by law.

**20. Independent Contractor.** The Contractor and its employees, volunteers and agents shall be and remain an independent contractor and not an agent or employee of the City with respect to all of the acts and services performed by and under the terms of this Agreement. This

Agreement shall not in any way be construed to create a partnership, association or any other kind of joint undertaking, enterprise or venture between the parties.

21. **Compliance with Laws.** The Contractor shall comply with all applicable laws, ordinances, rules, regulations, and lawful orders of public authorities in carrying out Services under this Agreement, and in particular shall obtain all required permits from all jurisdictional agencies to perform the Services under this Agreement at its own expense.
22. **Waiver.** The failure of either party to this Agreement to object to or to take affirmative action with respect to any conduct of the other which is in violation of the terms of this Agreement shall not be construed as a waiver of the violation or breach, or of any future violation, breach or wrongful conduct.
23. **Survival of Provisions.** Any terms or conditions of either this Agreement that require acts beyond the date of the term of the Agreement, shall survive termination of the Agreement, shall remain in full force and effect unless and until the terms or conditions are completed and shall be fully enforceable by either party.
24. **Prohibition of Contingency Fees.** The Contractor warrants that it has not employed or retained any company or person, other than a bona fide employee working solely for the Contractor, to solicit or secure this Agreement, and that it has not paid or agreed to pay any person(s), company, corporation, individual or firm, other than a bona fide employee working solely for the Contractor, any fee, commission, percentage, gift, or any other consideration, contingent upon or resulting from the award or making of this Agreement.
25. **Public Entity Crimes Affidavit.** Contractor shall comply with Section 287.133, Florida Statutes (Public Entity Crimes Statute), notification of which is hereby incorporated herein by reference, including execution of any required affidavit.
26. **Counterparts.** This Agreement may be executed in several counterparts, each of which shall be deemed an original and such counterparts shall constitute one and the same instrument.
27. **Conflicts; Order of Priority.** This document without exhibits is referred to as the “Base Agreement.” In the event of a conflict between the terms of this Base Agreement and any exhibits or attachments hereto, or any documents incorporated herein by reference, the conflict shall be resolved in the following order of priorities and the more stringent criteria for performance of the Services shall apply:
  - 27.1. First Priority: Base Agreement;
  - 27.2. Second Priority: Exhibit B – Fee Schedule (Form 12);
  - 27.3. Third Priority: Exhibit A – Section 2 from RFP No. 01-20/21;
  - 27.4. Fourth Priority: Contractor’s Proposal dated June 8, 2021.
28. **Non-Exclusive Agreement.** The City reserves the right to procure or acquire similar Services from another Contractor while this Agreement is in full force and effect.

**IN WITNESS WHEREOF**, the parties hereto have caused this Agreement to be executed the day and year as first stated above.

**CITY OF MIAMI SPRINGS**

**CONTRACTOR**

By: \_\_\_\_\_  
William Alonso, CPA, CGFO  
City Manager

By: \_\_\_\_\_  
Name: \_\_\_\_\_

Attest:

Title: \_\_\_\_\_

Entity: **GREATER MIAMI CATERERS, INC.**

By: \_\_\_\_\_  
Erika Gonzalez, MMC  
City Clerk

Approved as to form and legal sufficiency:

By: \_\_\_\_\_  
Weiss Serota Helfman Cole + Bierman, P.L.  
City Attorney

**Addresses for Notice:**

City of Miami Springs  
Attn: City Manager  
201 Westward Drive  
Miami Springs, FL 33166  
305-805-5011 (telephone)  
alonsow@miamisprings-fl.gov (email)

**Addresses for Notice:**

Greater Miami Caterers, Inc.  
4001 Northwest 31<sup>st</sup> Avenue  
Miami, FL 33142  
\_\_\_\_\_(telephone)  
\_\_\_\_\_(email)

**With a copy to:**

Weiss Serota Helfman Cole & Bierman, P.L.  
Attn: Haydee Sera, Esq.  
City of Miami Springs Attorney  
2525 Ponce de Leon Boulevard, Suite 700  
Coral Gables, FL 33134  
hsera@wsh-law.com (email)

**With a copy to:**

Greater Miami Caterers, Inc.  
c/o Peter Weintraub, Registered Agent  
7700 Congress Avenue, Suite 1110  
Boca Raton, FL 33487  
\_\_\_\_\_(telephone)  
\_\_\_\_\_(email)

## EXHIBIT A – COPY OF SECTION 2 FROM RFP

### SECTION 2

#### SCOPE OF SERVICES AND SPECIAL CONDITIONS

- 2.1** The Contractor shall provide all necessary labor, materials, equipment, reports and expertise required to provide the services, including but not limited to the tasks identified herein, which shall collectively be referred to as the “Services.” For purposes of the bid, “Contractor” is defined as a profit-making organization or a non-profit corporation licensed in the State of Florida, and with production kitchens within the State of Florida, that intends to prepare food for sale and/or distribution and is in compliance with the Food and Drug Administration and the United States Department of Agriculture and all other applicable federal and state regulations.
- 2.2** The City may elect to have the selected Contractor(s) provide all of these services, some of the services, or none of these services. The selected Contractor(s) is/are not guaranteed any work by the City under this solicitation. All projects will be coordinated with the City Manager and/or Senior Center Manager.
- 2.3** Bid Preference. Preference may be given to the vendor that provides the best quality and the shortest time span between packaging and delivery of hot food. Bids indicating price in effect at times of shipment will be considered invalid. The bidder shall be responsible for all fees, taxes, and licenses required to operate under the resulting contract and such expenses shall not be paid by the City.
- 2.4** Competency of Bidders.
- 2.4.1** The Contractor must provide documentation of ability and capability in providing the number of meals required to be provided with bid response. Pre-award inspection of the bidder’s facility may be made prior to the award of contract. Bids will be considered only from firms which are regularly engaged in the business of providing good and/or services as described in this bid with a good record of performance for a reasonable period of time and have sufficient financial support, equipment, and organization to ensure that they can satisfactorily execute the services if awarded a contract under the terms and conditions herein stated. The terms “equipment or organization” as used herein shall be construed to mean a fully equipped and well-established company in line with the best business practices in the industry and as determined by the proper authorities.
- 2.4.2** Bidder must be in compliance with state and local fire, health, sanitation, and safety regulations applicable to the type of food preparation and meals delivery system used by Bidder and said regulations must be adhered to during all stages of food service operations.
- 2.4.3** The City may consider any evidence available regarding the financial, technical, and other qualification and abilities of a Bidder; including past performance and experience in making the award in the best interest of the City.
- 2.5** Default.
- 2.5.1** In the event that the Contractor should fail to meet the terms of these bid specifications in any way, or should it cease its contractual responsibilities, the Contractor will be in default.
- 2.5.2** In case of default of the awarded bid, the City may procure the articles or services from other sources and charge the Contractor for meals, supplies, and any excess cost or liquidated damages incurred (actual and consequential damages).
- 2.5.3** In the event that the Contractor fails to deliver any meal, meals, portion of a meal, or other food and supplies at the designated sites within forty-five (45) minutes of the previously agreed upon time, or if the food does not meet the proper specifications (i.e., it is not delivered at proper temperatures, it is not fit for human consumption, menu items are omitted or

substituted without prior approval, or if supplies and containers are not delivered properly sealed or sanitized) the City is not required to pay and may procure a meal or meals or other foods and supplies elsewhere, deduct the price of the meals from Contractor and charge the Contractor the cost of such replacement supplies and/or meal, meals, and other food, plus the Nutrition Services Incentive Program's cash per meal allowance and any other expenses incurred by the City in procuring the replacement.

**2.5.4** Should the Contractor fail to adhere to the time schedule, deliver meals for a consecutive three (3) day period, fail to deliver meals for any (3) three days during a calendar month, then such action shall be deemed material non-performance of the contract and shall be justification for immediate cancellation of the contract.

**2.6** Bonding. The bidder shall be responsible for all fees for bonding of personnel and such expenses shall not be paid by the City.

**2.7** Audits. The Contractor's financial records must be open for audit purposes. The Contractor must supply all reports requested by the City, the Alliance for Aging, the Florida Department of Elder Affairs, the Administration on Aging, and the U.S. Department of Agriculture.

**2.8** Alliance for Aging Approval Required. Prior to the execution of a contract resulting from this solicitation, the Alliance for Aging, Inc. must approve the awarded vendor and contract. It is and shall be understood and agreed that such contract, as approved by the Alliance for Aging, Inc., shall be awarded and validly entered into between the Bidder and the City when written acceptance has been transmitted to the awardee by the City's authorized agent and that all requirements stipulated within this Request for Proposal will be strictly adhered to.

**2.9** Termination.

**2.9.1** The City may, by written notice to the successful Bidder, terminate the contract if the Bidder/Contractor has been found to have failed to perform his services in a matter satisfactory to the City as per specification including delivery as specified. It is the intention of the City to purchase the items specified herein from a source of supply that will give prompt, convenient, and proper shipment and service. Any failure of the supplier to comply with these conditions may be cause for terminating any resulting contract immediately upon written notice of the City. The City shall be the sole judge of non-performance/breach.

**2.9.2** In the event than any person eating meals prepared under this contract becomes ill as a result of food poisoning which is attributable to the negligence of the Contractor as determined by the Health Department Environmental Control Division, then such action shall be deemed material non- performance of the contract and City shall have justification for immediate cancellation of the contract.

**2.9.3** It is further agreed that, in the event funds to finance all or part of these Nutrition Programs for the Elderly become unavailable, the obligations of each party may be terminated upon no less than twenty (20) days' notice in writing to the other party. Said notice shall be in accordance with the notice provisions of the contract resulting from this RFP. The Florida Department of Elderly Affairs shall be final authority as to the availability of Federal or State Funds.

**2.10** Compliance with Laws.

**2.10.1** Bidders shall comply with all local, State, and Federal directives, orders and laws applicable to this bid and subsequent contract(s).

**2.10.2** Specific reference is made to 2020 Edition of the *DOEA Program and Services Handbook* (especially the sections contained in Attachment B of this document); Title VI and VII of the Civil Rights Acts; the Americans with Disabilities Act; and Section 504 of the vocational Rehabilitation Act of 1973.

**2.10.3** Pursuant to the Civil Rights Act of 1964 and the Americans with Disabilities Act of 1990, all Contractors and Sub-Contractors performing work in connection with this contract shall provide equal opportunity for employment and shall agree not to discriminate against an employee or applicant for employment because of race, religion, color, age, sex, national origin, place of birth, veteran status disability, perceived disability or any other legally protected group. It is expressly understood that upon evidence of such discrimination, the City shall have the right to immediately terminate said contract.

**2.11 Contractor's Employees.**

**2.11.1** All employees of the Contractor are solely the employees of the Contractor under its direction and not employees or agents of the City. The Contractor shall be responsible for all its employees' salaries and benefits including worker's compensation premiums and benefits. The Contractor shall provide competent and physically able employees. The City may require the Contractor to remove any employee it deems careless, incompetent, insubordinate, or otherwise objectionable and whose continued employment on the City's properties, or at citizens' homes, is not in the best interest of the City. Each employee shall have and wear proper attire and identification. All employees working in the preparation of food must ensure the application of hygienic techniques and practices in food handling, preparation, and service. Employees involved with delivery of home delivered meal must have DOEA Level 2 background screening on file and bidder must ensure that consumers served are at no risk of harm from their employees. City may request proof of DOEA Level 2 background screening.

**2.11.2** The Contractor should have a working knowledge of the Nutrition Program for the Elderly. The Contractor shall be available to the City for menu planning, recipe modification, and other required technical assistance. The name and the after-hours telephone number of the person whose primary responsibility is the management of the food service contract must be provided to the City.

**2.11.3** Each nutrition site shall be visited at least semi-annually by a managerial representative of the food service company to determine the quality of service and acceptability of food by participants and to become acquainted with the program that they are serving. Lines of communication shall be open between the Contractor and the City. The Contractor shall agree to employ older workers, if possible. The Contractor shall provide ongoing training in personal hygiene, sanitation and food handling to its kitchen staff and delivery personnel.

**2.11.4** If requested, the Contractor shall provide training in portion control and food handling to the City's employees at a time and place mutually agreed upon.

**2.12 Contract Pricing; Adjustments**

**2.12.1** The purpose of this solicitation is to establish a Contract for the purchase of the City's total needs for an initial one year term. Quantities stated are for bidders' guidance only and no guarantee is given or implied as to quantities that will be used during the contract period. Estimated quantities are based upon previous needs and estimated usage for the initial one year term.

**2.12.2** The prices established herein shall prevail (be maximum) for the term of the Contract with the benefit of any general reduction in commodity price during said period being passed on to the City. The City has the option to extend the contract for five additional twelve (12) month periods. Extension of the Contract is a City prerogative, not a right of the Contractor. Such option will be exercised only when it is in the best interest of the City to do so.

**2.12.3** Extension of the contract for any option year may be based on a price adjustment. Ninety (90) days prior to the date of Contract termination, the Contractor shall submit requested price adjustments to the City who shall consider said information along with other criteria in evaluating whether or not to exercise the City's option to renew the contract for an additional year. Such

requested price adjustment shall, in any event, not exceed the percentage increase shown by the "Consumer Price Index for Food, Etc.," published by the U.S. Department of Labor, Bureau of Statistics, for the 9th month after commencement of the services as compared with the index on the effective date of contract.

**2.13 RECORDS RETENTION.** The Contractor shall keep complete and accurate books, documents, papers and records (including electronic storage media) relating to the purchase of food and the storage, preparation, and transportation of the meals, including labor costs, raw food costs and records or receipts of storage and use of N.S.I.P. foods in accordance with generally accepted accounting procedures and practices consistently applied which sufficiently and properly reflect all revenues and expenditures of funds provided by the City of Miami Springs under the conditions of the Contract. Such records shall be kept for a period of at least six (6) years from the expiration or termination of the Contract. The books, documents and other records required to be maintained by the Contractor shall, upon their request and at a reasonable time and place, be made available for audit or examination purposes to authorized representatives of the City, the Department of Elder Affairs, the State Examiner or Public Accountant, the US Department of Health and Human Services, the US Comptroller General and another other Federal personnel pursuant to 7CFR 226. In the case of audit exception, all books, records, accounting records and other documents relative to this agreement, will be retained until such exception has been cleared or resolved to the satisfaction of these agencies.

**2.14 MONITORING REQUIREMENTS:**

**2.14.1** The Contractor will provide operational, sanitation, dietary, and fiscal reports as specified by the Area Agency on Aging and the City. These reports will be used for monitoring compliance with contractual stipulations.

**2.14.2** The Contractor will permit persons duly authorized by the City and the Alliance for Aging to inspect any records, papers, documents, food preparation areas, packaging and storage areas, food containers, automotive vehicles of the Provider, which are relevant to this contract, and/or interview any clients and employees of the Contractor to be assured of satisfactory performance of the terms and conditions of this subcontract. Following such inspection, the City or Alliance for Aging will deliver to the City of Miami Springs a list of its comments with regard to the manner in which said goods or services are being provided.

**2.14.3** The Contractor will rectify all noted deficiencies within the specified period of time set forth in the comments, or provide the City with a reasonable and acceptable justification for not correcting the noted shortcomings. The Contractor's failure to correct or justify within a reasonable time as specified by the City may result in the withholding of payments, being deemed in breach or default, or termination of this subcontract.

#### **MINIMUM FOOD CONTRACT SPECIFICATIONS AND TERMS**

**2.15 Scope.** It is the intent of the City to secure a contract for the purchase of:

**2.15.1** approximately 125 hot Congregate Meals a day (with actual variances of 90—125 ordered daily), Monday through Friday, excluding holidays, to the City of Miami Springs Adult Community Center located at 100 Apache Drive, Miami Springs;

**2.15.2** approximately 65 hot Home-Delivered Hot Lunch Weekday Meals a day (with actual variances of 50--65 ordered daily), Monday through Friday, and 65 cold Home-Delivered Lunch meals delivered each day on Saturday and Sunday (with actual variances of 50--65 ordered daily), with delivery to the individual homes or apartments of homebound residents of Miami Springs and Virginia Gardens; and

**2.15.3** approximately 65 weekday cold breakfast meals Home-Delivered (with actual variances of 50--65 ordered daily), delivered Monday-Sunday to the individual homes or apartments of homebound residents of Miami Springs, Florida.

**2.15.4** The locations and numbers of all Home-Delivered Meals are subject to change and will be established daily.

**2.16 DELIVERY SCHEDULE:**

**2.16.1** The total number of serving days will be a minimum of 253 for the contract year.

**2.16.2** Congregate Meals will NOT be delivered on Saturdays, Sundays, or days upon which the following holidays fall: New Year's Day; Martin Luther King Jr. Day; Memorial Day; Independence Day; Labor Day; Thanksgiving Day; Day after Thanksgiving; Veterans' Day; Christmas Day.

**2.16.3** Delivery schedules between food packaging and delivery should not exceed 4 hours.

**2.16.4** Congregate Meals must be delivered between 10:30 a.m. and 11:15 a.m. each weekday. Home-Delivered Meals are to be delivered between 11:30 a.m. and 1:30 p.m. each day. Deliveries made outside of the stated time range are not acceptable. The Contractor must adhere to a strict time schedule for delivering the congregate meal hot lunches and home delivered meal hot lunches.

**2.16.5** Deliveries made past the stated time range will result in the following:

**2.16.5.1** If congregate meals are received after 11:45 A.M., a thirty-three percent (33%) reduction on meal cost for the day will be made.

**2.16.5.2** If the meal is received after 12:00 noon, there will be reduction of fifty percent (50%).

**2.16.5.3** If the meal is delivered after 12:30 P.M., the project will not be liable for payment for meals delivered on that day.

**2.16.5.4** If for any reason City must procure meals from outside source due to non-delivery of meal, meal is spoiled or otherwise inedible; the contractor will be responsible for all costs incurred.

**2.16.5.5** City is not required to pay for meal that does not meet proper specifications.

**2.16.6** Upon delivery of meals to each congregate location, an authorized representative of the City shall sign a receipt in multiple copies evidencing receipt of such food, with two (2) copies to be retained by the Contractor and one (1) copy to be retained by the City. The delivery of disposable supplies shall occur at mutually convenient times between the City and the Contractor, and the type and number of surplus supplies to be stored at the City's site will be mutually agreed upon.

**2.17 FOOD CONTAINERS:**

**2.17.1** Food shall be delivered to nutrition site in bulk or individual meal containers. It shall be packaged so that there will be a minimum of spills in the carrier. The Contractor will take any necessary measures including, but not limited to, reducing fill level, and covering plates with stretch plastic film and/or aluminum foil and metal lids to prevent spillage. Carriers will be provided by the Contractor in a size and/or quantity to contain all food delivered to the site. Home delivered meals shall be individually packaged, packed in secondary insulated food carriers, and transported immediately under conditions that will ensure temperature control during delivery and prevent contamination and spillage. Cold and hot food shall be packaged and packed separately.

**2.17.2** All serving pans shall be of disposable aluminum and/or stainless steel. Any permanent ware will be retrieved by Contractor's personnel on the next delivery day and must be sanitized by the Contractor. Packaged materials must be supplied in containers that may be resealable after individual items are removed. Daily cleaning and sanitizing of utensils, pans, coolers,



carriers, and all other equipment provided by the Contractor shall be the responsibility of the Contractor.

**2.18 ESTIMATED QUANTITIES:**

**2.18.1** It shall be understood and agreed that quantities designated herein are estimates only and may be increased or decreased in accordance with the actual normal requirements of the City, and that the City in accepting any bid or portion thereof, contracts only and agrees to purchase only the supplies, equipment, and services in such quantities as represent the actual requirements of the City on a day-to-day basis.

**2.18.2** The Contractor shall be flexible regarding the number of meals to be provided at each site from day to day and in the delivery location for home delivered meals. The City will notify the Contractor by 3:00 P.M. of each serving day the number of meals required for the next serving day. This will constitute a purchase order which will cover the maximum billings for that order. At the time the contract is awarded, the City will give the Contractor the names of the people who are authorized to make the number of meals notification.

**2.19 TRANSPORTATION AND DELIVERY:**

**2.19.1** All deliveries will be made in trucks or vans that are capable of holding food at the required temperatures, and be clean and well-maintained.

**2.19.2** The Contractor shall develop and submit with the bid an emergency procedure for delivering food in the case the vehicle breakdowns or the driver fails to report for work.

**2.20 EQUIPMENT:**

**2.20.1** No equipment will be furnished or maintained by the City in the provision of meals; therefore, the Contractor shall supply and maintain all approved transportation, insulated containers and other appropriate equipment, service-ware, cups, straws, napkins, accessories, and condiments appropriate for the storage, preparation, delivery, and the serving of hot and cold foods, abiding by all safety measures and sanitary practices in handling operations. The Contractor shall replace unsanitary and damaged equipment.

**2.21 MENUS:**

**2.21.1** Menus shall be written in accordance with the Department of Elder Affairs (DOEA) standards specified in Chapter 3 of the *DOEA Programs and Services Handbook*, excerpts of which are attached hereto as Attachment B (Pages 3-106 through 3-129: Menu Review and Approval; Pages 3-130 through 3-132: Food Purchasing/Preparation Standards; Pages 3-133 through 3-139: Food Preparation and Safety Standards; and Pages 3-143 through 3-147: Food Service Contract Provisions) and which provide specific instruction for nutrition program policies. Contractor is responsible to strict adherence to these guidelines.

**2.21.2** Each menu page must be labeled with a line for the City's Qualified Dietician to sign on indicating his/her approval of the menu with nutritional analysis, along with a line for their license number as follows: Dietician Sign Off with Nutritional Analysis [INSERT]. License No. [INSERT].

**2.21.3** Menus must be designed/developed using the computer assisted nutrient analysis method and which ensures target nutrients are served in accordance with current nutritional standards, while also allowing menu component flexibility.

**2.21.4** Menus must comply with the current Dietary Guidelines for Americans published by the Secretary of Health and Human Services and the Secretary of Agriculture ([https://www.dietaryguidelines.gov/sites/default/files/2019-05/2015-2020\\_Dietary\\_Guidelines.pdf](https://www.dietaryguidelines.gov/sites/default/files/2019-05/2015-2020_Dietary_Guidelines.pdf)).

**2.21.5** Menus must comply with a minimum of 33 1/3% of the current Dietary Reference Intake nutritional needs of a 70+ moderately active female.

**2.21.6** Bidders are required to comply with semi-annual menu cycles (four week cycles for each six months).

- 2.21.7** Menu meal pattern must include appropriate portion size and identification of serving utensils to be used for each food item.
- 2.21.8** Menu must provide an indication of serving size of all menu components.
- 2.21.9** Menu must provide identification of serving utensil to be used for each food item.
- 2.22** TIMEFRAME FOR MENU SUBMISSION AND APPROVAL:
- 2.22.1** Following extensive collaboration with the City on planning all menus, the Contractor's Qualified Dietician will complete a computer assisted nutrition analysis of each menu and provide it to the City no less than eight (8) calendar weeks in advance of implementation. The City's Qualified Dietician will assure that provided menus comply with the nutritional analysis of each menu and will sign an Attestation Statement so certifying. Approved menu cycles may be repeated for the time periods of: January to June; and July to December. Menus must also be negotiated, and computer assisted nutritional analysis provided, for shelf stable boxed/emergency lunches and holiday meals.
- 2.22.2** Following the City's Qualified Dietician's analysis, menus will be submitted to the Alliance for Aging six (6) weeks prior to implementation for approval. Bidder should work in collaboration with City's Qualified Dietician in developing the menus in order to ensure compliance and ability of the Contractor to adhere to menu and to discuss ability to meet ethnic and regional preferences, seasoning, and preparation preferences and variety preferences.
- 2.23** MENU ACCEPTABILITY:
- 2.23.1** The City reserves the right to evaluate menu acceptability by its clientele and to require menu revisions when necessary.
- 2.24** MENU SUBSTITUTIONS:
- 2.24.1** Substitutions to the menu must be kept at a minimum and should be recorded and justified to the City. Any substitution of the menu must be in compliance with the City's pre-approved substitution list, which has been included as Attachment C. Substitutions to the approved menu cycles may not be made without prior approval by the City's Qualified Dietician, unless the food item is on the substitution list provided in Attachment C.
- 2.24.2** Substitutions must be a similar nutritional value and may not reduce the nutritional content of the meal.
- 2.24.3** Should the contractor expect that a substitution will be made in the future due to unavailability of an item, the request for substitution of a menu item must be made to the City in writing at least 2 weeks in advance in order to ensure that their consulting dietician has the proper amount of time to advise and approve of a suitable substitution.
- 2.24.4** The Contractor must provide the City a list of any and all substitutions made that include the date of substitution, the original menu items, the substitution made, and the reason for substitution to the City at the end of each month. It is mandatory that City be informed of the reason for substitution to keep on record. In the event that a substitution is made without prior approval, the City will not be responsible for payment for the unapproved menu item. Likewise, any menu item omitted will not be paid for by the City. The cost of said items shall be deducted from the bill at a rate to be determined at the time the contract is awarded. The Contractor shall provide immediate reimbursement for any out-of-pocket expenses incurred by the City when replacing part of or all of a meal that is not delivered or is not wholesome.
- 2.24.5** Contractor must provide a supply of substitution food items to be kept at the meal site in case a substitution is necessary.
- 2.25** SPECIAL MENU PROVISIONS:
- 2.25.1** The Contractor agrees to supply on a monthly basis, at no additional cost to the City, a 2½" square serving of birthday cake per person in place of the regular dessert item on an agreed date.

**2.25.2** The Contractor shall provide a traditional Thanksgiving, Christmas, and Easter meal, at no additional cost to the City, on a mutually agreed upon date. These meals will follow the holiday menus supplied by the Contractor and pre-approved by the City's Qualified Dietician and the Alliance for Aging, Inc.

**2.25.3** The Contractor agrees to furnish the aforementioned food for special occasions as scheduled by the City after a joint discussion of food service needs and with a seven (7) day advance notice.

**2.26** BOXED AND EMERGENCY LUNCHESES:

**2.26.1** As the City will be closed during certain holidays as stated in Section II Item B, the Contractor shall be prepared to supply boxed lunches at the same contracted meal unit cost to the City, if requested. The boxed lunch shall be delivered the day before the holiday for the same number of hot meals ordered that day. In addition, up to six (6) picnic meals may be requested by the City annually. These meals must be requested by the City at least one week prior to the serving date. Box lunches and picnic menu must also comply with all nutrition requirements and follow the menus initially provided by the Contractor and pre-approved by the City's Qualified Dietician.

**2.26.2** In any contract year, the City may request up to five menus for a take-home meal of non-perishable food for emergency use. The City shall request the non-perishable meals at least one week prior to the planned serving date.

**2.26.3** The Contractor agrees to have a contingency plan for supplying meals for at least 7 days in event of natural disasters, such as a hurricane, flood, fire, power failure, employee strikes, late supply shipments and similar circumstances which would prevent the Contractor from furnishing the meals in the usual fashion. Should the event or natural disaster be so severe that 7 days is not sufficient, the City may request additional meals.

**2.26.4** It is the responsibility of the City and the Contractor to provide each other with home telephone numbers and/or cell phone numbers for emergency use only.

**FOOD SANITATION AND SAFETY**

**2.27** FOOD PREPARATION AND SAFETY STANDARDS COMPLIANCE:

**2.27.1** It is mandated that the Contractor strictly adheres to food preparation and safety standards as stated in Attachment B (Pages 3-133 through 3-139).

**2.27.2** All applicable health and sanitation requirements shall be adhered to at the food preparation site/catering facility. Local, State, and Federal program authorities must have the right to inspect the premises and request formal inspection by health officials if deemed necessary.

**2.27.3** The food service vendor must not have had any temporary or permanent closures, Administrative Complaints regarding food safety, or 12 or more high priority/significant findings on sanitation inspections within the past 12 months, beginning July 1, 2018. Per Department of Business and Professional Regulation, "high priority violations could contribute directly to a foodborne illness or injury and could pose a direct or significant threat to public health, safety, or welfare." Per Department of Health, "an unsatisfactory inspection means that the violations were a significant threat to public health and sanitation and require correction before the next routine inspection."

**2.27.4** Meals may be prepared directly by provider (self-preparation kitchen) which serves one meal site or a central kitchen which serves many sites; or through a written contractual agreement with a vendor (school, restaurant, hospital); or a food service company and must comply with local, state (FAC 64E-11), and, if applicable, federal regulations.

**2.28 FOOD SAFETY MANAGEMENT:**

**2.28.1** The Contractor will provide documentation with its response to this Request for Proposal of their HACCP (Hazard Analysis Critical Control Point) food safety management program that addresses food safety issues such as: time/temperature, cross contamination, personal hygiene, proper storage procedures, holding and cooking of food items. This program must meet or exceed the minimum requirements of federal, state, municipal or other agencies authorized to inspect or accredit the food service operation. The Contractor must maintain this program in formal form at each central kitchen and this document is to be available for review upon request and at each annual inspection conducted by program staff or their representative.

**2.29 STATE INSPECTIONS:**

**2.29.1** The Contractor must provide documentation with this Request for Proposal of the food preparation inspections conducted by state regulatory authorities within the previous six months.

**2.29.2** The Contractor must provide documentation of the three most recent food preparation inspections conducted by the state regulatory authority.

**2.29.3** Following the award of contract, the City shall receive copies of inspection reports of the Contractor's facilities completed by health, sanitation, and safety officials within seventy-two (72) hours after receipt of the above by the contractor.

**2.29.4** The Contractor must provide a written plan of correction for any high priority or significant findings on sanitation inspections.

**2.29.5** The Contractor must notify the City immediately for any closures or Administrative Complaints regarding food safety; and notify the City within 24 hours of any sanitation inspections.

**2.30 DELIVERY STANDARDS:**

**2.30.1** The Contractor shall be responsible for the operation, insurance and maintenance of vehicles used in the delivery of food, supplies, etc. The Contractor will transport all food items in their own enclosed vehicles appropriate for delivery. All food transport equipment will be purchased, kept clean and be well-maintained by the Contractor. Food shall be packaged in equipment capable of maintaining hot food at 135° F or higher and cold food at 41° F or lower until the final site destination. The Contractor's personnel shall place cold food in the refrigeration units upon delivery to the City's meal site. All milk is to be iced down. The ice must be in a solid state at time of delivery. Temperatures of food at delivery will be confirmed with Contractor's personnel at arrival.

**2.30.2** In addition, the Contractor must deliver one home delivered test meal per month to the City's administrative office following the last delivery of the driver's route in order for the City to check temperature as part of quality compliance measure. If a problem with home delivered food temperatures is detected, more frequent monitoring will be conducted to ensure the problem is resolved. Documentation of the monitoring results will be maintained by the City.

**2.30.3** The contractor must provide a description of the vendor's delivery standards and sanitation that includes holding temperatures for transporting and serving food.

**2.31 OTHER INSPECTIONS:**

**2.31.1** The food preparation facility will be inspected annually by the City. Failure to comply with applicable health requirements shall result in termination of the contract.

**2.31.2** The City's Qualified Dietician, the DOEA, and Alliance for Aging staff shall be able to inspect food preparation, packaging, and storage areas at any time.

**2.32 DISPOSABLE SUPPLIES:**

**2.32.1** Each Contractor shall provide specifications of the disposable items they propose to use and shall provide samples of their proposed packaging with the bid submittal. The Contractor

shall be responsible for providing the following single service supplies to both congregate and home delivered sites with the following minimum specifications:

- 2.32.1.1** 6 ounce Styrofoam cups for coffee, tea, juice, or water for congregate meals;
- 2.32.1.2** 8 ounce Styrofoam soup bowls for soups, stews, chili, etc.;
- 2.32.1.3** 5 compartment, sturdy Styrofoam tray for congregate meals (in which at least three (3) compartments will hold half a cup of liquid each without spillage into other compartments);
- 2.32.1.4** 3 or 4 compartment, aluminum tray with fitted lid for home delivered meals.
- 2.32.1.5** Plastic coffee stirrers
- 2.32.1.6** 7"–8" individually wrapped straws;
- 2.32.1.7** Plastic-ware and napkins sealed in cellophane packets to include: non-brittle, heavy duty plastic fork, spoon, serrated knife, 3-ply napkin, and a packet of iodized salt (1/3 ounce portion) and a packet of pepper (1/16 ounce portion);
- 2.32.1.8** Individual packets of condiments to include ketchup, mustard, mayonnaise, tartar sauce, and relish will be provided when necessary to complete the meal. Salad dressing will be delivered in gallon jars/bottles on an as needed basis. Vinegar shall be provided when greens are on the menu;
- 2.32.1.9** The delivery of disposable supplies shall occur at a time mutually convenient to the City and the Contractor. The number of surplus supplies to be stored at the Congregate Meal site shall be agreed upon by the City and the Contractor.
- 2.32.1.10** Coffee, tea bags, individual packets of sugar, sugar substitute, milk and/or non-dairy creamer will be supplied by the Contractor on an as needed basis.

**2.33** FOOD STANDARDS:

**2.33.1** The Contractor shall purchase all foods used in the preparation of meals pursuant to this contract. All food purchased shall be of good quality and shall be obtained from sources which conform to federal, state, and local regulatory standards for quality, sanitation and safety. Only commercially processed, frozen, or canned foods or food approved by the USDA and the FDA may be used. No food prepared, frozen or canned in the home may be used in meals. When delivered to the nutrition site and client's home, the food shall be wholesome and of good quality.

**2.33.2** The portion of the meal for which NSIP funding is received must be food grown in the US. The Contractor must provide City with a letter stating the percentage of US grown food that is utilized in the preparation of the menus.

**2.33.3** No salt, "Accent", or other sodium condiment may be used in the preparation of food. No individual meal shall exceed 100 mg of sodium. No added sugar may be used. The use of saturated fats must be restricted in the menu planning and meal preparation.

**2.34** 2020 Edition of the *DOEA Program and Services Handbook*. The Contractor shall ensure and abide by all of the *Food Service Contract Provisions* described on Pages 3-143 through 3-147 of Chapter 3 of the 2020 Edition of the *DOEA Programs and Services Handbook*, which can be found attached hereto as Attachment B.

**END OF SECTION 2**

**EXHIBIT B –FEE SCHEDULE**

**[INSERT COPY OF CONTRACTOR'S PRICE PROPOSAL ON FORM 12 OF RFP]**



# Master Host • Greater Miami Caterers, Inc.



LANDMARKS IN THE FOOD SERVICE INDUSTRY

4001 N.W. 31st AVENUE, MIAMI, FLORIDA 33142

(305) 633-8066 • (305) 633-4616 Broward (954) 927 3266 • Fax (305) 635-5202

Web Site: [www.master-host.net](http://www.master-host.net) • E-mail: [info@mhcater.com](mailto:info@mhcater.com) • Alt. Fax (305) 635-0653

June 8, 2021

City of Miami Springs  
William Alonso, City Manager  
201 Westward Drive  
Miami springs, Fl. 33166

Re: Letter of Intent

Greetings from Greater Miami Caterers, Inc. (GMC) and its staff! As the uninterrupted and continuous caterer of the congregate and homebound meal program to the City of Miami Springs (CMS) since 1994, GMC may need little introduction to the CMS and its directors. Our partnership has stood the test of time and hopefully will continue for another six years at the conclusion of this bid process.

With the two principal oldest owners being previous graduates of Miami Springs Junior and Senior High, having lived on South Royal Poinciana Blvd. and Dove Ave. as we were growing up, to our mother who still lives on Dove Ave., our ties to the CMS are deeply rooted in the people we are today and to our commitment to the services we provide to the CMS. We continue to care deeply about the CMS as if we were still residents and have witnessed the tremendous progress the city has made over the years as we continue to serve the city, when attending to our mother's needs at her home or when visiting friends who live in "the Springs".

Our understanding of the work performed by GMC for the CMS is a very natural and organic process to our business operations. With over 28 years of experience performing the meal services, we have been subjected to every possible calamity from hurricanes, power interruptions at our kitchen or at the congregate facility, a fallen tree at the entrance of the congregate center, traffic diversions due to the regatta and water main breaks in the city and most recently the complete overhaul of all services to homebound frozen meals due to the pandemic, to mention a few. All operating decisions made on a daily basis use the CMS as the anchor of knowledge to our methodology of operations which allows us to be proactive rather than reactive to foreseen and unforeseen occurrences.

GMC continues to feel that we are positioned like no other to meet all aspects of the proposal and hope to earn that opportunity again for the next six years. Thank you for your consideration.

Sincerely,

John Olmo  
Vice-President







**Master Host • Greater Miami Caterers, Inc.**

LANDMARKS IN THE FOOD SERVICE INDUSTRY

4001 N.W. 31st AVE., MIAMI, FLORIDA 33142 • P.O. BOX 520752, MIAMI, FLORIDA 33152  
(305) 633-8066 • (305) 633-4616 • Broward (954) 927-3266 • Fax (305) 635-5202



**PROPOSAL FOR RFP No. 01-20/21**

**FOR CONGREGATE &  
HOMEBOUND-DELIVERD MEALS**

**FOR**

**THE CITY OF MIAMI SPRINGS  
ELDERLY COMMUNITY**

**Project Manager: John Olmo**  
**Phone: (305) 633-4616 Ext. 106**  
**E-mail: [jolmo@gmcater.com](mailto:jolmo@gmcater.com)**

**DATE: Thursday, June 10, 2021 - TIME: 2:30 PM**

# Table of Contents

Tab B

# CONTENTS

ITEMS

Page

<b>Tab A</b>	<b>Cover Page</b>	<b>1</b>
<b>Tab B</b>	<b>Table of Contents</b>	<b>3</b>
<b>Tab C</b>	<b>Letter of Intent</b>	<b>7</b>
<b>Tab D</b>	<p><b>Firm's Qualifications</b> – Form 2, Company Qualifications Questionnaire.</p> <p><b>D-1</b> To be eligible to respond, the Contractor shall have five (5) years of continuous operation under the same entity name and provide proof of same.</p> <p><b>D-2</b> Contractor must include any relevant business licenses, including occupational licenses, and Florida registration (entity certifications, not personal) and a copy of the entity's State Corporate Certificate or other proof from the State of Florida, Division of Corporations that Contractor is authorized to do business in this State.</p> <p><b>D-3</b> Contractor must also provide copies of:</p> <ul style="list-style-type: none"> <li>i. A valid Florida Department of Health Food Management Certificate;</li> <li>ii. A valid Florida Department of Business and Professional Regulations Food Vendors/Catering certificate</li> <li>iii. Proof of registration with the State of Florida's Department of Elder Affairs, Food and Nutrition Management Program</li> <li>iv. The vendor's most current annual inspection report from the Florida Department of Health. The report must show corrective action, if applicable, where deficiencies are noted.</li> </ul> <p><b>D-4</b> Contractor must provide copies of its professional and business licenses and insurance, qualifier for company name and type of licenses, as well as those for supporting firms, contractors, or subcontractors.</p> <p><b>D-5</b> Contractor shall provide a list of current and past clients, with emphasis on Florida municipalities.</p> <p><b>D-6</b> Contractor must also provide the official complaint history within the last five (5) years for its qualifying professional license.</p> <p><b>D-7</b> Contractor shall identify the Principal in Charge's Experience. This individual must have a minimum of five (5) years' experience in providing the Services. This individual must be capable of speaking and making decisions on behalf of the Contractor.</p> <p><b>D-8</b> The team working on the Project must have prior experience within the past ten (10) years of providing similar services. (SEE FORM 8)</p>	<p><b>9</b></p> <p><b>13</b></p> <p><b>16</b></p> <p><b>20</b></p> <p><b>46</b></p> <p><b>51</b></p> <p><b>53</b></p> <p><b>55</b></p> <p><b>59</b></p>
<b>Tab E</b>	<p><b>Project Team/Personnel Qualifications</b></p> <p><b>E-1</b> Complete and submit Form 8, Key Staff and Proposed Subcontractors.</p> <p><b>E-2</b> Provide an organizational chart showing reporting structure for all Key Staff, including any key subcontractors (the "Project Team").</p> <p><b>E-3</b> Include a one-page resume with contact information for at least three (3) professional references for the individual designated to serve as Principal in Charge or</p>	<p><b>61</b></p> <p><b>62</b></p> <p><b>65</b></p> <p><b>67</b></p>

	<p>Program Manager.</p> <p><b>E-4</b> Include one-page resumes for each person or subcontractor listed in Form 8, Key Staff and Proposed Subcontractors. Resumes should include experience with similar projects, specifying the role the individual employee served on the project.</p>	72
<b>Tab F</b>	<p><b>Services Implementation Strategy</b></p> <p><b>F-1</b> Financial Capabilities</p> <p><b>F-2</b> Food Transportation Systems Meal Service &amp; Delivery Description</p> <p><b>F-3</b> Comprehensive Emergency Management and Contingency Plans</p> <p><b>F-4</b> Quality Assurance Measures</p> <p><b>F-5</b> Disaster Food Service Preparedness</p> <p><b>F-6</b> Approved four week menu cycle homebound and congregate menus, breakfast, shelf stable meals, boxed lunches, special event &amp; holiday and picnic menus.</p> <p><b>F-7</b> Formal sanitation program and checklists, HACCP programs and other food safety programs</p> <p><b>F-8</b> Acknowledgement of US grown food that is utilized in the preparation of the menus.</p>	<p>82</p> <p>83</p> <p>86</p> <p>89</p> <p>91</p> <p>93</p> <p>96</p> <p>117</p> <p>135</p>
<b>Tab G</b>	<b>Price Proposal – FORM 12</b>	137
<b>Tab H</b>	<b>Insurance</b>	142
<b>Tab I</b>	<b>Bid Security Bond – FORM 13</b>	145
<b>Tab J</b>	<p><b>References</b></p> <p><b>J-1</b> Complete and submit Form 9, References.</p> <p><b>J-2</b> Submit three (3) letters of references, which shall each include the following information from the referencing individual: Name; Position; Entity; Address; Telephone Number; Email Address; Contract Date and Value; Description of Project/Work; and Total cost of the project/work/studies, estimated and actual.</p>	<p>149</p> <p>153</p>
<b>Tab K</b>	<p><b>Forms:</b> Complete all forms provided in Section 4 that are not otherwise previously included in a separate tab.</p> <ul style="list-style-type: none"> <li>- Form 1 Proposal Checklist</li> <li>- Form 3A Certificate of Authority (Corporation)</li> <li>- Form 4 Acknowledgement of Addenda w/ Amendments 1 &amp; 2</li> <li>- Form 5 Single Execution Affidavits</li> <li>- Form 6 Certification for Disclosure of Lobbying Activities on Federal-Aid Contracts</li> <li>- Form 7 Dispute Disclosure</li> <li>- Form 10 E-Verify Affidavit</li> <li>- Form 11 IRS Form W-9</li> </ul>	<p>157</p> <p>158</p> <p>159</p> <p>160</p> <p>167</p> <p>175</p> <p>176</p> <p>177</p> <p>181</p>

<b>Attachment A</b>	Form of Professional Services Agreement	188
<b>Attachment B</b>	Excerpts from the 2020 Edition of the DOEA Programs and Services Handbook – Chapter 3 – Title III and Title VII of the Older Americans Act (OAA)	210
<b>Attachment C</b>	City of Miami Springs' Menu Substitution Policy and Procedures Guideline and Menu Substitution Log	253
<b>Attachment D</b>	<p>Sample Paper Goods</p> <ul style="list-style-type: none"> <li>- 6050 Aluminum Tray w/ Lid</li> <li>- 6132 Aluminum Tray w/ Lid</li> <li>- Lunch Tray 5-Compartment</li> <li>- Homebound Aluminum 3-Compartment Tray w/ Lid</li> <li>- Combo Pack 6/1 (Napkin, Spoon, Fork, Knife, Salt &amp; Pepper) and Straw</li> <li>- 8 oz. Styrofoam Cup</li> <li>- 8 oz. Styrofoam Bowl</li> <li>- 705 Aluminum Tray w/ Lid</li> <li>- Bread Sealing Plastic Bag</li> <li>- 6 oz. Plastic Cup w/ Lid</li> </ul>	260
<b>Attachment E</b>	Menu Attestation and Nutrient Analysis	270

# Letter of Intent

Tab C



# Master Host · Greater Miami Caterers, Inc.



LANDMARKS IN THE FOOD SERVICE INDUSTRY

4001 N.W. 31st AVENUE, MIAMI, FLORIDA 33142

(305) 633-8066 • (305) 633-4616 Broward (954) 927 3266 • Fax (305) 635-5202

Web Site: [www.master-host.net](http://www.master-host.net) • E-mail: [info@mhccater.com](mailto:info@mhccater.com) • Alt. Fax (305) 635-0653

June 8, 2021

City of Miami Springs  
William Alonso, City Manager  
201 Westward Drive  
Miami springs, Fl. 33166

Re: Letter of Intent

Greetings from Greater Miami Caterers, Inc. (GMC) and its staff! As the uninterrupted and continuous caterer of the congregate and homebound meal program to the City of Miami Springs (CMS) since 1994, GMC may need little introduction to the CMS and its directors. Our partnership has stood the test of time and hopefully will continue for another six years at the conclusion of this bid process.

With the two principal oldest owners being previous graduates of Miami Springs Junior and Senior High, having lived on South Royal Poinciana Blvd. and Dove Ave. as we were growing up, to our mother who still lives on Dove Ave., our ties to the CMS are deeply rooted in the people we are today and to our commitment to the services we provide to the CMS. We continue to care deeply about the CMS as if we were still residents and have witnessed the tremendous progress the city has made over the years as we continue to serve the city, when attending to our mother's needs at her home or when visiting friends who live in "the Springs".

Our understanding of the work performed by GMC for the CMS is a very natural and organic process to our business operations. With over 28 years of experience performing the meal services, we have been subjected to every possible calamity from hurricanes, power interruptions at our kitchen or at the congregate facility, a fallen tree at the entrance of the congregate center, traffic diversions due to the regatta and water main breaks in the city and most recently the complete overhaul of all services to homebound frozen meals due to the pandemic, to mention a few. All operating decisions made on a daily basis use the CMS as the anchor of knowledge to our methodology of operations which allows us to be proactive rather than reactive to foreseen and unforeseen occurrences.

GMC continues to feel that we are positioned like no other to meet all aspects of the proposal and hope to earn that opportunity again for the next six years. Thank you for your consideration.

Sincerely,

John Olmo

Vice-President

## **Firm's Qualifications**

Tab D



CITY OF MIAMI SPRINGS  
REQUEST FOR PROPOSALS NO. 01-20/21

**FORM 2**  
**COMPANY QUALIFICATIONS QUESTIONNAIRE**

Please complete this Company Qualifications Questionnaire. By completing this form and submitting a response to the RFP, you certify that any and all information contained in the Proposal is true, that your response to the RFP is made without prior understanding, agreement, or connections with any corporation, firm or person submitting a response to the RFP for the same materials, supplies, equipment, or services, is in all respects fair and without collusion or fraud, that you agree to abide by all terms and conditions of the RFP, and certify that you are authorized to sign for the Respondent's firm.

Some responses may require the inclusion of separate attachments. Separate attachments should be as concise as possible, while including the requested information. In no event should the total page count of all attachments to this Form exceed five (5) pages. Some information may not be applicable; in such instances, please insert "N/A".

Greater Miami Caterers, Inc.  
Firm Name  
4001 N.W. 31<sup>st</sup> Avenue, Miami, FL 33142  
Principal Business Address  
(305) 633-4616 Telephone Number (305) 635-5202 Facsimile Number  
jolmo@gmccater.com  
Email Address  
59-1209174 Federal I.D. No. or Social Security Number 3550978 Municipal Business Tax/Occupational License No.

**FIRM HISTORY AND INFORMATION**

How many years has the firm has been in business under its current name and ownership? 53 YEARS

Please identify the Firm's document number with the Florida Division of Corporations and date the Firm registered/filed to conduct business in the State of Florida:

327444 Document Number 03/13/1968 Date Filed

Please identify the Firm's category with the Florida Department of Business Professional Regulation (DBPR), DBPR license number, and date licensed by DBPR:

Hotels and Restaurants Category CAT2326832 License No. 09/23/20 Date Licensed

Please indicate the type of entity form of the Firm (if other, please describe):

Individual  Partnership  Corporation  LLC  LLP  Other \_\_\_\_\_

Please identify the Firm's primary business: INSTITUTIONAL FOOD SERVICES

Please identify the number of continuous years your Firm has performed its primary business: 53 YEARS

**CITY OF MIAMI SPRINGS  
REQUEST FOR PROPOSALS NO. 01-20/21**

Please list all professional licenses and certifications held by the Firm, its Qualifier/Principal, and any Key Staff, and the name of the entity that issued the license or certification:

License/Certification Type	Name of Entity Issuing License or Certification	License No.	License Issuance Date
Catering Business	DBPR division of Hotels and Restaurants	CAT2326832	09/23/20

Please identify the name, license number, and issuance date of any prior companies that pertain to your Firm:

License/Certification Type	Name of Entity Issuing License or Certification	License No.	License Issuance Date
N/A			

Please identify all individuals authorized to sign for the entity, their title, and the threshold/level of their signing authority:

Authorized Signor's Name	Title	Signing Authority Threshold (All, Cost up to \$X-Amount, No Cost, Other)
Jacqueline Butler	President	ALL
John Olmo	Vice-President	ALL

Please identify the total number of Firm employees, managerial/administrative employees, and identify the total number of trades employees by trade (e.g., 20 electricians, 5 laborers, 2 mechanics, etc.):

Total No. of Employees	105
Total No. of Managerial/Administrative Employees	19
Total No. of Trades Employees by Trade	0

**INSURANCE INFORMATION**

Please provide the following information about the Firm's insurance company:

KEYS Coverage Insurance Vanessa Marcano  
 Insurance Carrier Name Insurance Carrier Contact Person  
 5900 Hiatus Rd, Tamarac, FL (954) 724-7000 vmarcano@keyscoverage.com  
 Insurance Carrier Address Telephone No. Email

Has the Firm filed any insurance claims in the last five (5) years? No  Yes If yes, please identify the type of claim and the amount paid out under the claim: AUTO ACCIDENTS: 1) \$28,000 + 2) \$10,000

**CITY OF MIAMI SPRINGS  
REQUEST FOR PROPOSALS NO. 01-20/21**

**FIRM OWNERSHIP**

Please identify all Firm owners or partners, their title, and percent of ownership:

Owner/Partner Name	Title	Ownership (%)
Jacqueline Butler	President	56%
John Olmo	Vice-President	24%
John Butler	Kitchen Manager	20%

Please identify whether any of the owners/partners identified above are owners/partners in another entity:

No  Yes If yes, please identify the name of the owner/partner, the other entity's name, and percent of ownership held by the stated owner/partner:

Owner/Partner Name	Other Entity Name	Ownership (%)

**RECENT CONTRACTS**

Please identify the five (5) most recent contracts in which your Firm has provided services to other public entities:

Public Entity Name	Contact Person	Telephone No.	Email Address	Date Awarded
Miami-Dade County	Rani Panchanathan	(786) 469-4789	Rani.Panchanathan@miamidade.gov	7/1/19
Little Havana	Betty Ruano-Bond	(786) 234-6524	Betty.Ruano@lhanc.org	10/01/18
Hialeah Housing	Ileana Sanabria	(305) 888-9744	Isanabria@hialeahhousing.org	4/1/18
Southwest Social	S. Mario Mendez	(305) 218-1667	mmendez@southwestsocial.org	7/17/17
West Miami	Yolanda Aguilar	(305) 263-8900	Yolanda.Aguilar@cityofwestmiami.org	10/1/15

By signing below, Respondent certifies that the information contained herein is complete and accurate to the best of Respondent's knowledge.

Firm: Greater Miami Caterers, Inc.

Authorized Signature: 

Date: 6/10/21

Print or Type Name: John Olmo

Title: Vice-President

**D- 1**

Tab D-1



Department of State / Division of Corporations / Search Records / Search by Entity Name /

## Detail by Entity Name

Florida Profit Corporation

GREATER MIAMI CATERERS, INC.

### Filing Information

**Document Number** 327444  
**FEI/EIN Number** 59-1209174  
**Date Filed** 03/13/1968  
**State** FL  
**Status** ACTIVE  
**Last Event** REINSTATEMENT  
**Event Date Filed** 07/08/1991

### Principal Address

4001 NORTHWEST 31ST AVENUE  
 MIAMI, FL 33142

Changed: 07/08/1991

### Mailing Address

4001 NORTHWEST 31ST AVENUE  
 MIAMI, FL 33142

Changed: 07/08/1991

### Registered Agent Name & Address

Weintraub, Peter  
 7700 Congress Ave.  
 Suite 1110  
 Boca Raton, FL 33487

Name Changed: 04/08/2019

Address Changed: 04/02/2021

### Officer/Director Detail

#### **Name & Address**

Title PST

BUTLER, JACQUELINE  
 1461 N.E. 102ND STREET  
 MIAMI SHORES, FL 33138

14

Title V

OLMO, JOHN  
318 SW 163 AVE  
PEMBROKE PINES, FL 33027

**Annual Reports**

<b>Report Year</b>	<b>Filed Date</b>
2019	04/08/2019
2020	03/27/2020
2021	04/02/2021

**Document Images**

<a href="#"><u>04/02/2021 – ANNUAL REPORT</u></a>	View image in PDF format
<a href="#"><u>03/27/2020 – ANNUAL REPORT</u></a>	View image in PDF format
<a href="#"><u>04/08/2019 – ANNUAL REPORT</u></a>	View image in PDF format
<a href="#"><u>04/02/2018 – ANNUAL REPORT</u></a>	View image in PDF format
<a href="#"><u>02/23/2017 – ANNUAL REPORT</u></a>	View image in PDF format
<a href="#"><u>03/01/2016 – ANNUAL REPORT</u></a>	View image in PDF format
<a href="#"><u>02/27/2015 – ANNUAL REPORT</u></a>	View image in PDF format
<a href="#"><u>04/01/2014 – ANNUAL REPORT</u></a>	View image in PDF format
<a href="#"><u>01/22/2013 – ANNUAL REPORT</u></a>	View image in PDF format
<a href="#"><u>01/30/2012 – ANNUAL REPORT</u></a>	View image in PDF format
<a href="#"><u>03/31/2011 – ANNUAL REPORT</u></a>	View image in PDF format
<a href="#"><u>05/10/2010 – ANNUAL REPORT</u></a>	View image in PDF format
<a href="#"><u>03/24/2009 – ANNUAL REPORT</u></a>	View image in PDF format
<a href="#"><u>03/17/2008 – ANNUAL REPORT</u></a>	View image in PDF format
<a href="#"><u>05/10/2007 – ANNUAL REPORT</u></a>	View image in PDF format
<a href="#"><u>03/13/2006 – ANNUAL REPORT</u></a>	View image in PDF format
<a href="#"><u>03/01/2005 – ANNUAL REPORT</u></a>	View image in PDF format
<a href="#"><u>02/27/2004 – ANNUAL REPORT</u></a>	View image in PDF format
<a href="#"><u>04/21/2003 – ANNUAL REPORT</u></a>	View image in PDF format
<a href="#"><u>04/18/2002 – ANNUAL REPORT</u></a>	View image in PDF format
<a href="#"><u>04/27/2001 – ANNUAL REPORT</u></a>	View image in PDF format
<a href="#"><u>02/26/2000 – ANNUAL REPORT</u></a>	View image in PDF format
<a href="#"><u>04/08/1999 – ANNUAL REPORT</u></a>	View image in PDF format
<a href="#"><u>02/27/1998 – ANNUAL REPORT</u></a>	View image in PDF format
<a href="#"><u>03/17/1997 – ANNUAL REPORT</u></a>	View image in PDF format
<a href="#"><u>02/06/1996 – ANNUAL REPORT</u></a>	View image in PDF format

**D- 2**

Tab D-2

Ron DeSantis, Governor

Halsey Beshears, Secretary

STATE OF FLORIDA  
DEPARTMENT OF BUSINESS AND PROFESSIONAL REGULATION  
DIVISION OF HOTELS AND RESTAURANTS

LICENSE NUMBER: CAT2326832

EXPIRATION DATE: OCTOBER 1, 2021

THE CATERER (2013) HEREIN IS LICENSED UNDER THE  
PROVISIONS OF CHAPTER 509, FLORIDA STATUTES

GREATER MIAMI CATERERS INC  
GREATER MIAMI CATERERS INC  
4001 NW 31 AVE  
/2 BUILDINGS  
MIAMI FL 33142



ISSUED: 09/23/2020

Always verify licenses online at MyFloridaLicense.com

Do not alter this document in any form.

This is your license. It is unlawful for anyone other than the licensee to use this document.

000030

Local Business Tax Receipt

Miami-Dade County, State of Florida  
-THIS IS NOT A BILL - DO NOT PAY



3550978

BUSINESS NAME/LOCATION  
GREATER MIAMI CATERERS INC  
4001 NW 31ST AVE  
MIAMI FL 33142

RECEIPT NO.  
RENEWAL  
1070499

EXPIRES  
SEPTEMBER 30, 2021

Must be displayed at place of business  
Pursuant to County Code  
Chapter 8A - Art. 9 & 10



OWNER  
GREATER MIAMI CATERERS INC

SEC. TYPE OF BUSINESS  
195 CATERING BUSINESS  
CAT2326832

PAYMENT RECEIVED  
BY TAX COLLECTOR  
\$75.00 07/27/2020  
CHECK21-20-063861

Employee(s) 5

This Local Business Tax Receipt only confirms payment of the Local Business Tax. The Receipt is not a license, permit, or a certification of the holder's qualifications, to do business. Holder must comply with any governmental or nongovernmental regulatory laws and requirements which apply to the business.

The RECEIPT NO. above must be displayed on all commercial vehicles - Miami-Dade Code Sec 8a-276.

For more information, visit [www.miamidade.gov/taxcollector](http://www.miamidade.gov/taxcollector)





[Department of State](#) / [Division of Corporations](#) / [Search Records](#) / [Search by FEI/EIN Number](#) /

## Detail by FEI/EIN Number

Florida Profit Corporation  
GREATER MIAMI CATERERS, INC.

### Filing Information

**Document Number** 327444  
**FEI/EIN Number** 59-1209174  
**Date Filed** 03/13/1968  
**State** FL  
**Status** ACTIVE  
**Last Event** REINSTATEMENT  
**Event Date Filed** 07/08/1991

### Principal Address

4001 NORTHWEST 31ST AVENUE  
MIAMI, FL 33142

Changed: 07/08/1991

### Mailing Address

4001 NORTHWEST 31ST AVENUE  
MIAMI, FL 33142

Changed: 07/08/1991

### Registered Agent Name & Address

Weintraub, Peter  
7700 Congress Ave.  
Suite 1110  
Boca Raton, FL 33487

Name Changed: 04/08/2019

Address Changed: 04/02/2021

### Officer/Director Detail

#### **Name & Address**

Title PST

BUTLER, JACQUELINE  
1461 N.E. 102ND STREET  
MIAMI SHORES, FL 33138

18

Title V

OLMO, JOHN  
318 SW 163 AVE  
PEMBROKE PINES, FL 33027

**Annual Reports**

<b>Report Year</b>	<b>Filed Date</b>
2019	04/08/2019
2020	03/27/2020
2021	04/02/2021

**Document Images**

<a href="#"><u>04/02/2021 -- ANNUAL REPORT</u></a>	<a href="#">View image in PDF format</a>
<a href="#"><u>03/27/2020 -- ANNUAL REPORT</u></a>	<a href="#">View image in PDF format</a>
<a href="#"><u>04/08/2019 -- ANNUAL REPORT</u></a>	<a href="#">View image in PDF format</a>
<a href="#"><u>04/02/2018 -- ANNUAL REPORT</u></a>	<a href="#">View image in PDF format</a>
<a href="#"><u>02/23/2017 -- ANNUAL REPORT</u></a>	<a href="#">View image in PDF format</a>
<a href="#"><u>03/01/2016 -- ANNUAL REPORT</u></a>	<a href="#">View image in PDF format</a>
<a href="#"><u>02/27/2015 -- ANNUAL REPORT</u></a>	<a href="#">View image in PDF format</a>
<a href="#"><u>04/01/2014 -- ANNUAL REPORT</u></a>	<a href="#">View image in PDF format</a>
<a href="#"><u>01/22/2013 -- ANNUAL REPORT</u></a>	<a href="#">View image in PDF format</a>
<a href="#"><u>01/30/2012 -- ANNUAL REPORT</u></a>	<a href="#">View image in PDF format</a>
<a href="#"><u>03/31/2011 -- ANNUAL REPORT</u></a>	<a href="#">View image in PDF format</a>
<a href="#"><u>05/10/2010 -- ANNUAL REPORT</u></a>	<a href="#">View image in PDF format</a>
<a href="#"><u>03/24/2009 -- ANNUAL REPORT</u></a>	<a href="#">View image in PDF format</a>
<a href="#"><u>03/17/2008 -- ANNUAL REPORT</u></a>	<a href="#">View image in PDF format</a>
<a href="#"><u>05/10/2007 -- ANNUAL REPORT</u></a>	<a href="#">View image in PDF format</a>
<a href="#"><u>03/13/2006 -- ANNUAL REPORT</u></a>	<a href="#">View image in PDF format</a>
<a href="#"><u>03/01/2005 -- ANNUAL REPORT</u></a>	<a href="#">View image in PDF format</a>
<a href="#"><u>02/27/2004 -- ANNUAL REPORT</u></a>	<a href="#">View image in PDF format</a>
<a href="#"><u>04/21/2003 -- ANNUAL REPORT</u></a>	<a href="#">View image in PDF format</a>
<a href="#"><u>04/18/2002 -- ANNUAL REPORT</u></a>	<a href="#">View image in PDF format</a>
<a href="#"><u>04/27/2001 -- ANNUAL REPORT</u></a>	<a href="#">View image in PDF format</a>
<a href="#"><u>02/26/2000 -- ANNUAL REPORT</u></a>	<a href="#">View image in PDF format</a>
<a href="#"><u>04/08/1999 -- ANNUAL REPORT</u></a>	<a href="#">View image in PDF format</a>
<a href="#"><u>02/27/1998 -- ANNUAL REPORT</u></a>	<a href="#">View image in PDF format</a>
<a href="#"><u>03/17/1997 -- ANNUAL REPORT</u></a>	<a href="#">View image in PDF format</a>
<a href="#"><u>02/06/1996 -- ANNUAL REPORT</u></a>	<a href="#">View image in PDF format</a>

**D- 3**

Tab D-3

**servsafe**  
National Restaurant Association

# ServSafe® CERTIFICATION

## LUIS PORRAS

for successfully completing the standards set forth for the ServSafe® Food Protection Manager Certification Examination, which is accredited by the American National Standards Institute (ANSI)—Conference for Food Protection (CFP).



#0655

2/21/2021

DATE OF EXPIRATION  
Local laws apply. Check with your local health department for recertification requirements.

*[Signature]*  
Sherman  
Executive Director

Association Solutions

CERTIFICATION NUMBER

10744

EXAM FORM NUMBER

2/21/2026

DATE OF EXPIRATION

D3 i.



In accordance with ANSI Accredited Program requirements, the ServSafe logo are trademarks of the NRAEF, National Restaurant Association® and the arc design

Contact us with questions at 233 S. Wacker Drive, Suite 3600, Chicago, IL 60606-6383 or ServSafe@restaurant.org.

21

**ServSafe**  
National Restaurant Association

# ServSafe® CERTIFICATION

## WILSON ELIVO

for successfully completing the standards set forth for the ServSafe® Food Protection Manager Certification Examination, which is accredited by the American National Standards Institute (ANSI)-Conference for Food Protection (CFP).



#0655

In accordance with...

CERTIFICATION NUMBER

10744

EXAM FORM NUMBER

2/21/2021

DATE OF EXPIRATION  
Local laws apply. Check with your local health department for recertification requirements.

2/21/2026

DATE OF EXPIRATION

Sherrill  
Elivo

Association Solutions



D3 L.

22

The ServSafe logo are trademarks of the NRAEF, National Restaurant Association® and the arc design

Contact us with questions at 233 S. Wacker Drive, Suite 3600, Chicago, IL 60606-6383 or ServSafe@restaurant.org.

**servsafe**  
National Restaurant Association

# ServSafe® CERTIFICATION

## KAREN AVILA

for successfully completing the standards set forth for the ServSafe® Food Protection Manager Certification Examination, which is accredited by the American National Standards Institute (ANSI)—Conference for Food Protection (CFP).

10744

EXAM FORM NUMBER

2/21/2026

DATE OF EXPIRATION

for recertification requirements.

2/21/2021

DATE OF EXPIRATION  
Local laws apply. Check with your local health department for recertification requirements.



#0655

In accordance with...

and the ServSafe logo are trademarks of the NRAEF, National Restaurant Association® and the arc design

Contact us with questions at 233 S. Wacker Drive, Suite 3600, Chicago, IL 60606-6383 or ServSafe@restaurant.org.



DB i.

23

**ServSafe**  
National Restaurant Association

# ServSafe® CERTIFICATION

MARTHA MARIA ZALDIVAR QUINTERO

for successfully completing the standards set forth for the ServSafe® Food Protection Manager Certification Examination, which is accredited by the American National Standards Institute (ANSI)—Conference for Food Protection (CFP).



#0655

In accordance with ANSI...

2/21/2021

DATE OF EXPIRATION  
Local laws apply. Check with your local health department for recertification requirements.

2/21/2026

DATE OF EXPIRATION

10744

EXAM FORM NUMBER



D3 L

24

The ServSafe logo are trademarks of the NRAEF, National Restaurant Association® and the arc design

Contact us with questions at 233 S. Wacker Drive, Suite 3600, Chicago, IL 60606-6383 or ServSafe@restaurant.org.

D3 il.

Ron DeSantis, Governor

Halsey Beshears, Secretary

STATE OF FLORIDA  
DEPARTMENT OF BUSINESS AND PROFESSIONAL REGULATION  
DIVISION OF HOTELS AND RESTAURANTS

LICENSE NUMBER: CAT2326832

EXPIRATION DATE: OCTOBER 1, 2021

THE CATERER (2013) HEREIN IS LICENSED UNDER THE  
PROVISIONS OF CHAPTER 509, FLORIDA STATUTES

GREATER MIAMI CATERERS INC  
GREATER MIAMI CATERERS INC  
4001 NW 31 AVE  
/2 BUILDINGS  
MIAMI FL 33142



Always verify licenses online at MyFloridaLicense.com

Do not alter this document in any form.

This is your license. It is unlawful for anyone other than the licensee to use this document.

ISSUED: 09/23/2020

000030

Local Business Tax Receipt

Miami-Dade County, State of Florida

-THIS IS NOT A BILL - DO NOT PAY



3550978

BUSINESS NAME/LOCATION

GREATER MIAMI CATERERS INC  
4001 NW 31ST AVE  
MIAMI FL 33142

RECEIPT NO.

RENEWAL  
1070499

EXPIRES

SEPTEMBER 30, 2021

Must be displayed at place of business  
Pursuant to County Code  
Chapter 8A - Art. 9 & 10



OWNER:

GREATER MIAMI CATERERS INC

SEC. TYPE OF BUSINESS

195 CATERING BUSINESS  
CAT2326832

PAYMENT RECEIVED  
BY TAX COLLECTOR

\$75.00 07/27/2020  
CHECK21-20-063861

Employee(s) 5

This Local Business Tax Receipt only confirms payment of the Local Business Tax. The Receipt is not a license, permit, or a certification of the holder's qualifications, to do business. Holder must comply with any governmental or nongovernmental regulatory laws and requirements which apply to the business.

The RECEIPT NO. above must be displayed on all commercial vehicles - Miami-Dade Code Sec 8a-276.

For more information, visit [www.miamidade.gov/taxcollector](http://www.miamidade.gov/taxcollector)

25



Adult Care Food Program (ACFP) Approved Caterer List 2020-2021

D3 iii

Caterer	Contact Information	Serving Counties
<i>South Florida</i>		
<b>1710 Rest, Inc.</b> <b>DBA Tatiana Restaurant</b> <b>Tatiana Varzar</b> <b>1710 East Hallandale Beach Boulevard</b> <b>Hallandale, FL 33008</b>	<b>Ph: (954) 454-1222</b> <b>Email: tatiana_restaurant@yahoo.com</b>	<b>Broward, Miami Dade</b>
<b>A Marshall Catering &amp; Takeout II</b> <b>Gregory Marshall</b> <b>613 East Atlantic Boulevard</b> <b>Pompano Beach, FL 33060</b>	<b>Ph: (954) 889-4410</b> <b>Email: amarshallcatering@gmail.com</b>	<b>Broward</b>
<b>AFF Catering, Inc.</b> <b>Abel Ferro</b> <b>25355 Southwest 121st Place</b> <b>Princeton, FL 33032</b>	<b>Ph: (786) 447-3259</b> <b>affcatering@gmail.com</b>	<b>Miami Dade</b>
<b>Aging Matters in Brevard</b> <b>DBA Community Services Council</b> <b>Tom Kammerdener</b> <b>3600 West King Street</b> <b>Cocoa, FL 32926</b>	<b>Ph: (321) 636-9901</b> <b>Email: tkammerdener@agingmattersbrevard.org</b>	<b>Brevard</b>
<b>Annabella Café, Corp.</b> <b>Viises Fernandez</b> <b>600 West 27th Street</b> <b>Hialeah, FL 33010</b>	<b>Ph: (786) 537-5383</b> <b>Email: annabellacafe@outlook.com</b>	<b>Broward, Miami Dade, Monroe</b>
<b>Aroma Catering, Inc.</b> <b>Arianna Gomez</b> <b>530 Sharazad Boulevard</b> <b>Opa Locka, FL 33054</b>	<b>Ph: (305) 330-5432</b> <b>Email: aromacatering12@gmail.com</b>	<b>Broward, Miami Dade</b>
<b>Chef Corp, Inc.</b> <b>John Carlino</b> <b>5745 Columbia Circle</b> <b>Mangonia Park, FL 33407</b>	<b>Ph: (561) 281-2531</b> <b>Email: chefcarlino@chefcorp.com</b>	<b>Broward, Martin, Palm Beach</b>
<b>Chebere Appetite, Inc.</b> <b>DBA Sergio's Catering</b> <b>Ricardo Gonzalez</b> <b>4720 Northwest 167th Street</b> <b>Miami Gardens, FL 33014</b>	<b>Ph: (786) 486-0264</b> <b>Email: ricardo@sergioscatering.com</b>	<b>Broward, Miami Dade, Palm Beach</b>
<b>Coco's Bakery, Inc.</b> <b>Santa Castaneda</b> <b>2590 Pine Island Road, Unit 2E</b> <b>Cape Coral, FL 33909</b>	<b>Ph: (786) 712-3477</b> <b>Email: santcastaneda@gmail.com</b>	<b>Lee</b>

**Adult Care Food Program (ACFP) Approved Caterer List 2020-2021**

<p><b>Construction Catering, Inc.</b> Berta Ramos 2620-30 West 2nd Avenue Hialeah, FL 33010</p>	<p>Ph: (786) 486-0147 Email: constructioncateringinc1@gmail.com</p>	<p>Broward, Miami Dade</p>
<p><b>David's Food and Fun, Inc.</b> DBA Dixie Catering Cristian Taglieri 2630 West 2nd Avenue Hialeah, FL 33010</p>	<p>Ph: (305) 255-7427 Email: dixieribs@gmail.com</p>	<p>Broward, Miami Dade</p>
<p><b>ECRS, LLC.</b> DBA Big Chef Rosana Calambichis 4811 South State Road 7 Davie, FL 33314</p>	<p>Ph: (954) 965-2480 x. 1 Email: order@bigchefonline.com</p>	<p>Broward, Miami Dade, Palm Beach</p>
<p><b>El Mundo Supermarket, Corp.</b> Isabel Cruz / Aymee Paula 1177 West 35th Street Hialeah, FL 33012</p>	<p>Ph: (786) 342-8104 / (786) 280-9614 Email: elmundosupermarket@gmail.com aymeepaula@gmail.com</p>	<p>Miami Dade</p>
<p><b>Elite Catering Services of Miami, LLC.</b> Carlos Gomez 7700 NW 37th Avenue Miami, FL 33147</p>	<p>Ph: (786) 488-3638 Email: elitecateringservicesofmiami@gmail.com</p>	<p>Miami Dade</p>
<p><b>GA Foods Service, Inc.</b> Tonya Moosue 1750 McNab Road Fort Lauderdale, FL 33309</p>	<p>Ph: (954) 972-8884 Email: fkneen@gafoods.com</p>	<p>Broward, Martin, Miami Dade, Palm Beach, St. Lucie</p>
<p><b>Gaby's Café, Inc.</b> Yudaisy B. Hernandez 1351 Southwest 1st Street Miami, FL 33135</p>	<p>Ph: (305) 519-0575 Email: yudaisy@aol.com</p>	<p>Miami Dade</p>
<p><b>Greater Miami Caterers, Inc.</b> John Olmo 4001 Northwest 31st Avenue Miami, FL 33142</p>	<p>Ph: (305) 633-4616 x. 106 Email: jolmo@gmccater.com</p>	<p>Broward, Miami Dade, Monroe, Palm Beach</p>
<p><b>Miami Nutrition Catering, Inc.</b> Alejandro Santana 420 Palm Avenue Hialeah, FL 33010</p>	<p>Ph: (786) 553-8488 Email: alesan13@msn.com</p>	<p>Miami Dade</p>



**Adult Care Food Program (ACFP) Approved Caterer List 2020-2021**

<p><b>Randazzo Catering</b>  <b>DBA Creative Tastes Catering</b>  <b>Frank Randazzo</b>  <b>12229 SW 131st Avenue</b>  <b>Miami, FL 33186</b></p>	<p><b>Ph: (305) 256-8399</b>  <b>Email: frank@creativetastes.com</b></p>	<p><b>Broward, Collier, Miami Dade, Monroe, Palm Beach</b></p>
<p><b>Restaurante El Sabor Latino 2 Corp.</b>  <b>Edgar Perez</b>  <b>2202 Joy Road</b>  <b>Greenacres, FL 33415</b></p>	<p><b>Ph: (561) 906-7772</b>  <b>Email: elsaborlatino4391@comcast.net</b></p>	<p><b>Palm Beach</b></p>
<p><b>Rusky, LLC.</b>  <b>DBA Kavkaz Restaurant</b>  <b>Ekaterina Chabalina</b>  <b>15504 Biscayne Boulevard</b>  <b>North Miami, FL 33160</b></p>	<p><b>Ph: (786) 280-2986</b>  <b>Email: kavkazmiami@gmail.com</b></p>	<p><b>Broward, Miami Dade</b></p>
<p><b>Senior Service Solutions</b>  <b>Theresa Dali</b>  <b>4550 West 12th Avenue</b>  <b>Hialeah, FL 33012</b></p>	<p><b>Ph: (954) 901-0104</b>  <b>Email: seniohomecaresfl@gmail.com</b></p>	<p><b>Broward, Miami Dade</b></p>
<p><b>Star of the Sea Foundation, Inc.</b>  <b>Emily Nixon</b>  <b>5640 Maloney Avenue</b>  <b>Key West, FL 33040</b></p>	<p><b>Ph: (781) 820-8286</b>  <b>Email: emily@sosmission.org</b></p>	<p><b>Monroe</b></p>
<p><b>Sterling Group Foods</b>  <b>DBA Sterling Kosher</b>  <b>Jonathan Rapp</b>  <b>5850 South Pine Island Road</b>  <b>Davie, FL 33328</b></p>	<p><b>Ph: (954) 680-4787</b>  <b>Email: lmiano@sterlinggroupfoods.com</b></p>	<p><b>Broward, Miami Dade</b></p>
<p><b>Summer Impressions</b>  <b>DBA Tossed &amp; Wrapped</b>  <b>Oleg Itslovich</b>  <b>801 North Congress Avenue, Suite 715</b>  <b>Boynton Beach, FL 33426</b></p>	<p><b>Ph: (347) 925-6581</b>  <b>Email: tossedwrap@gmail.com</b></p>	<p><b>Broward, Miami Dade, Palm Beach</b></p>
<p><b>Tammy's Catering, Inc.</b>  <b>Liset Nunez</b>  <b>10311 NW 58th Street</b>  <b>Doral, FL 33178</b></p>	<p><b>Ph: (786) 501-9620</b>  <b>Email: tammyscateringinc@hotmail.com</b></p>	<p><b>Miami Dade</b></p>
<p><b>The Lord's Place, Inc.</b>  <b>DBA Joshua Catering Company</b>  <b>Robert Coleman</b>  <b>P.O. Box 3265</b>  <b>West Palm Beach, FL 33407</b></p>	<p><b>Ph: (561) 683-2094</b>  <b>Email: rcoleman@thelordsplace.org</b></p>	<p><b>Palm Beach</b></p>

28

**Adult Care Food Program (ACFP) Approved Caterer List 2020-2021**

<p><b>The Soup Shop, Inc.</b>                  Julie Shipley                  4100 North Wickham Road, Suite #104                  Melbourne, FL 32935</p>	<p><b>Ph: (321) 693-7484</b>                  Email: <a href="mailto:thesoupshopfl@gmail.com">thesoupshopfl@gmail.com</a></p>	<p><b>Brevard</b></p>
<p><b>Tu Cocinita Catering, Inc.</b>                  Sahidy Tolibia                  2430 West 8th Avenue                  Hialeah, FL 33010</p>	<p><b>Ph: (786) 445-1379</b>                  Email: <a href="mailto:sahidy1234@yahoo.es">sahidy1234@yahoo.es</a></p>	<p><b>Broward, Miami Dade, Palm Beach</b></p>
<p><b>Yummy in my Tummy, LLC.</b>                  Karen Stanley                  12691 West Sunrise Boulevard                  Sunrise, FL 33323</p>	<p><b>Ph: (305) 710-7314</b>                  Email: <a href="mailto:karen@yummyinmytummy.com">karen@yummyinmytummy.com</a></p>	<p><b>Broward, Miami Dade, Palm Beach</b></p>
<b>Central Florida</b>		
<p><b>Alvic, Inc.</b>                  DBA Vic's Embers                  Victor Donalley                  1005 West Main Street                  Leesburg, FL 34748</p>	<p><b>Ph: (352) 636-9097</b></p>	<p><b>Lake</b></p>
<p><b>Don Miller Development</b>                  DBA Pier 22 Catering                  Dana Johnson                  10670 Boardwalk Loop                  Lakewood Ranch, FL 34202</p>	<p><b>Ph: (941) 748-8087</b>                  Email: <a href="mailto:dana@pier22.com">dana@pier22.com</a></p>	<p><b>Charlotte, Desoto, Hardee, Highlands, Hillsborough, Manatee, Orange, Osceola, Pinellas, Polk, Sarasota</b></p>
<p><b>Doing Dinner</b>                  Rick Miller                  2135 SW 19th Avenue Road, Suite #102                  Ocala, FL 34471</p>	<p><b>Ph: (352) 875-7199</b>                  Email: <a href="mailto:rick@doingdinner.com">rick@doingdinner.com</a></p>	<p><b>Marion</b></p>
<p><b>GA Foods Services, Inc.</b>                  Frank Kneen                  12200 32nd Court North                  St. Petersburg, FL 33716</p>	<p><b>Ph: (727) 573-2211 x. 377</b>                  Email: <a href="mailto:fkneen@gafoods.com">fkneen@gafoods.com</a></p>	<p><b>Hillsborough, Manatee, Pasco, Pinellas, Polk, Sarasota</b></p>
<p><b>GA Foods Services, Inc. - Center Hill</b>                  Karen Richardson                  27 North Maryland Avenue                  Center Hill, FL 33514</p>	<p><b>Ph: (352) 793-4553</b>                  Email: <a href="mailto:fkneen@gafoods.com">fkneen@gafoods.com</a></p>	<p><b>Alachua, Citrus, Hernando, Lake, Marion, Sumter</b></p>
<p><b>GA Foods Services, Inc. - Daytona Beach</b>                  Arnaldo Gonzales                  780 Fentress Boulevard                  Daytona Beach, FL 32114</p>	<p><b>Ph: (386) 274-5600</b>                  Email: <a href="mailto:fkneen@gafoods.com">fkneen@gafoods.com</a></p>	<p><b>Brevard, Orange, Osceola, Seminole, Volusia</b></p>

**Adult Care Food Program (ACFP) Approved Caterer List 2020-2021**

<p><b>GA Foods Services, Inc. - Fort Myers</b>                  Job Jean "JJ" Noel                  5501 Division Drive                  Fort Myers, FL 33905</p>	<p><b>Ph: (239) 693-5090</b>  <b>Email: fkneen@gafoods.com</b></p>	<p><b>Charlotte, Collier, Desoto, Glades, Hardee, Hendry, Highlands, Lee, Sarasota</b></p>
<p><b>Let's Eat Fresh, LLC.</b>                  Rosaria Little                  809 North Magnolia Avenue                  Ocala, FL 34475</p>	<p><b>Ph: (352) 299-5233</b>  <b>Email: letseatfresh@yahoo.com</b></p>	<p><b>Marion</b></p>
<p><b>Metz Culinary Management</b>                  Jack Brill                  1540 Northgate Boulevard                  Sarasota, FL 34234</p>	<p><b>Ph: (941) 536-4701</b>  <b>Email: jbrill@metzcorp.com</b></p>	<p><b>Charlotte, Citrus, Collier, Desoto, Hardee, Hillsborough, Indian River, Lake, Lee, Manatee, Marion, Orange, Pinellas, Polk, Sarasota</b></p>
<p><b>Meals on Wheels, Etc.</b>                  Sherry Fincher                  2801 South Financial Court                  Sanford, FL 32773</p>	<p><b>Ph: (407) 333-8877 x. 110</b>  <b>Email: sfincher@mealsetc.org</b></p>	<p><b>Lake, Orange, Osceola, Seminole, Volusia</b></p>
<p><b>Second Harvest Food Bank of Central FL</b>                  DBA Plates of Plenty                  Nancy Brumbaugh                  411 Mercy Drive                  Orlando, FL 32805</p>	<p><b>Ph: (407) 514-1031</b>  <b>Email: nbrumbaugh@feedhopenow.org</b></p>	<p><b>Lake, Orange, Osceola, Seminole</b></p>
<b>North Florida</b>		
<p><b>Elder Care Services, Inc.</b>                  Michael Henderson                  2518 West Tennessee Street                  Tallahassee, FL 32304</p>	<p><b>Ph: (850) 245-5941</b>  <b>Email: hendersonm@ecsbigbend.org</b></p>	<p><b>Leon</b></p>
<p><b>Glady's Catering Service</b>                  Phyllis Hall                  623 Beechwood Street                  Jacksonville, FL 32206</p>	<p><b>Ph: (904) 307-3341</b>  <b>Email: raeceen@gmail.com</b></p>	<p><b>Duval</b></p>
<p><b>Glo's Homestyle Cooking</b>                  Glory Mitchell                  623 Beechwood Street                  Jacksonville, FL 32208</p>	<p><b>Ph: (904) 729-3275</b>  <b>Email: glorymitchell1356@gmail.com</b></p>	<p><b>Duval</b></p>

Adult Care Food Program (ACFP) Approved Caterer List 2020-2021

<p><b>Junkanoo Shack</b> <b>Thomas Fore</b> <b>133 West 6th Street</b> <b>Jacksonville, FL 32206</b></p>	<p><b>Ph: (904) 438-0865</b> <b>Email: junkanooshackllc@gmail.com</b></p>	<p><b>Duval</b></p>
--	---	---------------------

D3 iv.

**STATE OF FLORIDA**  
**DIVISION OF HOTELS AND RESTAURANTS**  
**DEPARTMENT OF BUSINESS AND PROFESSIONAL REGULATION**  
www.myfloridalicense.com

**Food Service Inspection Report**

This inspection report must be made public upon request per Florida law.

**Met Inspection Standards during this visit**  
**ANY VIOLATIONS noted herein must be corrected by the**  
**NEXT UNANNOUNCED inspection unless otherwise stated.**

Inspection Date: Apr 15, 2021 08:56 - Apr 15, 2021 11:17	License Expiration: October 1, 2021
License Number: 2326832 Rank: CATR	Inspection Reason: Routine - Food
Owner Name: GREATER MIAMI CATERERS INC	Business Name: GREATER MIAMI CATERERS INC
Location Address: 4001 NW 31 AVE, /2 BUILDINGS MIAMI FL 33142	License Type: Catering
Number of Units: 0	Telephone Number: 305-633-4616
	Reinspection on or After:

**FOODBORNE ILLNESS RISK FACTORS AND PUBLIC HEALTH INTERVENTIONS**

01A Food obtained from approved source	IN	07 Unwrapped or PH/TCS food not re-served	IN
01B Food safe and unadulterated; sound condition	IN	08A Separating raw animal foods from: each other, RTE foods and unwashed produce	IN
01C Shellstock tags; commingling	N/A	08B Food protection during preparation, storage and display	IN
01D Parasite destruction for raw/undercooked fish	N/A	09 Bare hand contact with RTE food; Alternative Operating Procedure (AOP)	IN
02A Consumer advisory on raw/undercooked oysters	N/A	11 Employee health knowledge; ill/symptomatic employee present	IN
02B Consumer advisory on raw/undercooked animal foods	N/A	12A Hands clean and washed properly; use of hand antiseptic if use of AOP	IN
02C Date marking ready-to-eat (RTE) potentially hazardous / time/ temperature control for safety foods	IN	12B Employee eating, drinking, tasting food, smoking	IN
03A Receiving and holding PH/TCS foods cold	IN	22 Food-contact surfaces clean and sanitized	IN
03B Receiving and holding PH/TCS foods hot	N/O	31A Handwash sink(s) installed, accessible, not used for other purposes	OUT
03C Cooking raw animal foods and plant foods; non-continuous cooking of raw animal foods	N/O	31B Handwashing supplies and handwash sign provided	OUT
03D Cooling PH/TCS foods; proper cooling methods	N/O	41 Chemicals/toxic substances	IN
03E Reheating PH/TCS foods for hot holding	N/O	53A Food manager certification; knowledge/active managerial control (except employee health)	IN
03F Time as a Public Health Control	N/A	53B State approved food handler training; employee duty specific training/knowledge	IN
03G Reduced oxygen packaging (ROP) and other Special Processes	N/A		

**GOOD RETAIL PRACTICES**

02D Food items properly labeled; original container		35A No presence or breeding of insects/rodents/pests; no live animals	
04 Facilities to maintain PH/TCS foods at the proper temperature		35B Outer openings protected from insects/pests, rodent proof	
05 Food and food equipment thermometers provided and accurate		36 Floors, walls, ceilings and attached equipment properly constructed and clean; rooms and equipment properly vented	OUT
06 PH/TCS foods properly thawed		38 Lighting provided as required; fixtures shielded or bulbs protected	
10 In use food dispensing utensils properly stored		40 Employee personal belongings	
13 Clean clothes; hair restraints; jewelry; painted/artificial fingernails		42 Cleaning and maintenance equipment	
14 Food-contact and nonfood contact surfaces designed, constructed, maintained, installed, located		43 Complete separation from living/sleeping area/private premise; kitchen restricted - no unauthorized personnel	
16 Dishwashing facilities; chemical test kit(s); gauges 1. Wash 2. Rinse 3. Sanitize	OUT	45 Fire extinguishing equipment (FOR REPORTING PURPOSES ONLY)	

**STATE OF FLORIDA**  
**DIVISION OF HOTELS AND RESTAURANTS**  
**DEPARTMENT OF BUSINESS AND PROFESSIONAL REGULATION**  
www.myfloridalicense.com

21	Wiping cloths; clean and soiled linens; laundry facilities		46	Exits not blocked or locked (FOR REPORTING PURPOSES ONLY)	
23	Non-food contact surfaces clean	<b>OUT</b>	47	Electrical wiring/outlets in good repair (FOR REPORTING PURPOSES ONLY)	
24	Storage/handling of clean equipment, utensils; air drying		48	Gas appliances; boiler certificate current/posted (FOR REPORTING PURPOSES ONLY)	
25	Single-service and single-use items		49	Flammable/combustible materials (FOR REPORTING PURPOSES ONLY)	
27	Water source safe, hot (100F) and cold under pressure		50	Current license, properly displayed	
28	Sewage and waste water disposed properly		51	Other conditions sanitary and safe operation	
29	Plumbing installed and maintained; mop sink; water filters; backflow prevention		52	Misrepresentation; misbranding	
32	Bathrooms		54	Florida Clean Indoor Air Act Compliance	
33	Garbage and refuse; premises maintained	<b>OUT</b>	55	Automatic Gratuity Notice	

Items marked IN are in compliance. Items marked OUT are violations. Specific details of the violations are listed on subsequent pages. Items marked N/A are Not Applicable. Items marked as N/O are Not Observed and were not being conducted at the time of inspection.

**FOOD TEMPERATURES**

<b>Bar Area</b>	
<b>Buffet Line</b>	
<b>Cook Line</b>	
<b>Front Counter</b>	
<b>Front Line</b>	
<b>Kitchen</b>	
<b>Prep Area</b>	potatoes with vegetables (92-94°F - Cooling); beef with potatoes (144-150°F - Cooling)
<b>Reach In Cooler</b>	
<b>Reach In Freezer</b>	
<b>Steam Table/Bain Marie</b>	yellow rice with chicken (160°F - Hot Holding); beans and rice (144°F - Hot Holding); beans and rice (137°F - Hot Holding)
<b>Storage Area</b>	ground beef (42°F - Cold Holding); ground beef (43°F - Cold Holding); cooked broccoli (frozen°F); cooked corn pudding (38°F - Cold Holding); cooked yuca (38°F - Cold Holding); pork (40°F - Cold Holding); beans (83°F - Cooling); chicken in sauce (42°F - Cold Holding); turkey (32°F - Cold Holding); mashed potatoes (45°F - Cooling)
<b>Wait Station</b>	
<b>Walk In Cooler</b>	sour cream (37°F - Cold Holding); portioned yogurt (62°F - Cooling); rice (197°F - Cooling)
<b>Walk In Freezer</b>	vegetable soup (frozen°F - Cold Holding); chicken tenders (frozen°F - Cold Holding); baked swai (frozen°F - Cold Holding); broccoli (frozen°F - Cold Holding); vegetable soup (34°F - Cooling)

**OTHER ITEMS**

**Certified Food Manager and Date Certified:** Iran German Fumero Morales 01-12-2020  
**Manager Certified By:** 360training.com, Inc. (Learn2Serve)  
**Employees Trained By:** Other Approved Corporate Training  
**Sewage:** Municipal/Utility  
**Water Source:** Municipal  
**Boiler:** Boiler Certificate Provided  
**Boiler Jurisdiction and Expiration:** FL021616 expires on 11-20-21



**STATE OF FLORIDA**  
**DIVISION OF HOTELS AND RESTAURANTS**  
**DEPARTMENT OF BUSINESS AND PROFESSIONAL REGULATION**  
[www.myfloridalicense.com](http://www.myfloridalicense.com)

**Sanitizer Details:**

Sanitizer Bucket (Quaternary 200ppm); Triple Sink (Quaternary - Not Set Up); Dishwasher  
(Temperature 190°F)

**Inspector Comments:** At the time of the inspection calibrated thermometer with manager both thermometers read 32°F.  
Joint inspection with inspector Audrey Elder.

Provided "Responding to COVID-19 in the Workplace" flyer from the Florida Department of Health. This includes updated employee screening protocol.

For the most updated and reliable information and guidance regarding COVID-19 in Florida, please visit the Florida Department of Health's dedicated COVID-19 webpage, available at: [www.flhealth.gov/covid19](http://www.flhealth.gov/covid19)

Self-print licenses: the DBPR is transitioning to self-print licenses and will no longer mail out licenses. For more information visit: <http://www.myfloridalicense.com/DBPR/hotels-restaurants/> "

A link to the Florida Department of Agriculture's Food Recovery Resource Guide is located at:  
<http://www.myfloridalicense.com/DBPR/hotels-restaurants/forms-publications>

This report has been provided electronically as requested by the person in charge at the time of inspection.

**VIOLATIONS**

- 16-07-4 Observed: Accumulation of debris in three-compartment sink.**  
Priority: Basic
  
- 16-23-4 Observed: Accumulation of lime scale on the inside of the dishmachine.**  
Priority: Basic
  
- 23-12-4 Observed: Walk-in cooler and/or walk-in freezer shelves soiled with encrusted food debris.**  
Priority: Basic
  
- 23-24-4 Observed: Buildup of food debris/soil residue on equipment door handles.**  
Located at walk in oven.  
Priority: Basic
  
- 31A-02-4 Observed: Handwash sink not accessible for employee use due to being blocked by storage rack. Located inside walk in cooler.**  
Manager moved storage rack. \*\*Corrected On-Site\*\*  
Priority: Intermediate
  
- 31A-13-4 Observed: Employee used handwash sink as a dump sink.**  
Observed at hand sink in walk in cooler.  
Priority: Intermediate
  
- 31B-02-4 Observed: No paper towels or mechanical hand drying device provided at handwash sink.**  
Located near preparation area and women's bathroom. \*\*Corrected On-Site\*\*  
Priority: Intermediate
  
- 33-14-4 Observed: Dumpster overflowing garbage.**  
Priority: Basic
  
- 36-22-4 Observed: Floor area(s) covered with standing water.**  
Located around cooking pots at kitchen area.  
Priority: Basic
  
- 36-26-4 Observed: Wall soiled with accumulated black debris in dishwashing area.**  
Priority: Basic
  
- 36-41-4 Observed: Fan cover in walk-in cooler has accumulation of dust or debris.**  
Priority: Basic

**STATE OF FLORIDA**  
DIVISION OF HOTELS AND RESTAURANTS  
DEPARTMENT OF BUSINESS AND PROFESSIONAL REGULATION  
www.myfloridalicense.com



Signature of Recipient

John Butler

Gm

7867975528

Apr 15, 2021 11:17



Inspector Signature

Natalie Cabanas, Senior Inspector  
DBPR, Division of Hotels & Restaurants

8420 NW 52nd Ter, Suite 101

Doral, FL 33166

305 629 1882

Apr 15, 2021 11:17



# Master Host • Greater Miami Caterers, Inc.



LANDMARKS IN THE FOOD SERVICE INDUSTRY

4001 N.W. 31st AVENUE, MIAMI, FLORIDA 33142

(305) 633-8066 • (305) 633-4616 Broward (954) 927 3266 • Fax (305) 635-5202

## IMMEDIATE CORRECTIVE ACTIONS and PLANS of ACTION to HEALTH DEPARTMENT INSPECTION of 4/15/21

**16-07-4 Observed:** Accumulation of debris in 3-compartment sink. Corrective Action – The 3-compartment sink was thoroughly cleaned inside and out to remove any residues. Plan of Action – This item will be added to the regular sanitation inspection program to prevent a repeat occurrence.

**16-23-4 Observed:** Accumulation of lime scale on the inside of the dish machine. Corrective Action – The dish machine was put through a descaling process by adding the descaling chemical and running it through multiple cycles to remove all scaling. Plan of Action – This item will be added to the regular sanitation inspection program to prevent a repeat occurrence.

**23-12-4 Observed:** Walk-in cooler and/or walk-in freezer shelves soiled with encrusted food debris. Corrective Action – The mesh shelving will be removed and replaced with standard wire shelving. Plan of Action – All storage facilities will be inspected for additional instances of mesh shelving with the intention of replacing those as well for standard wire shelving.

**23-24-4 Observed:** Buildup of food debris/soil residue on equipment door handles. Corrective Action – The oven door handle in question was cleaned thoroughly. Plan of Action – This item will be highlighted within the regular sanitation inspection program to prevent a repeat occurrence.

**31A-02-4 Observed:** Handwashing sink not accessible for employee use due to being blocked by storage rack. Corrective Action – As indicated in the inspection report, the rolling rack was moved to clear the path therefore this was immediately “Corrected On-Site”. Plan of Action – The new department manager was made aware of the need to keep the path to the hand washing sink clear for employee usage.

**31A-13-4 Observed:** Employee used handwashing sink as a dump sink. Corrective Action – The hand sink was thoroughly cleaned inside and out. Plan of Action – The new department manager was made aware of the need to monitor employee activities, particularly in terms of improper use of equipment by using the hand washing sink to rinse any food products.

**31B-02-4 Observed:** No paper towels or mechanical hand drying device provided at handwashing sink. Corrective Action – As indicated in the inspection report, the two empty paper towel dispensers were immediately refilled “Corrected On-Site”. Plan of Action – A review will be performed on the typical replacement schedule for empty dispensers so that they contain paper towels during peak employee usage times.



# Master Host • Greater Miami Caterers, Inc.

LANDMARKS IN THE FOOD SERVICE INDUSTRY

4001 N.W. 31st AVENUE, MIAMI, FLORIDA 33142

(305) 633-8066 • (305) 633-4616 Broward (954) 927 3266 • Fax (305) 635-5202



**33-14-4 Observed:** Dumpster overflowing garbage. Corrective Action – The garbage company performed their standard daily pick-up to clear the full dumpsters. Plan of Action – The dumping of the lightweight, but bulky Styrofoam boxes which filled up the dumpsters will be held just prior to the time that the garbage company performs their daily pick-up.

**36-22-4 Observed:** Floor area covered with standing water. Corrective Action – The area was mopped to remove the standing water. Plan of Action – We recently contracted our flooring repair man to resurface the area to remove these low-lying spots where water was accumulating, but the job was unsuccessful in eliminating all water retention. The mopping schedule in the area will be accelerated to keep up with future water retention.

**36-26-4 Observed:** Wall soiled with accumulated black debris in dishwashing area. Corrective Action – All walls within the dishwashing area were thoroughly cleaned. Plan of Action – This item will be added to the regular sanitation inspection program to prevent a repeat occurrence.

**36-41-4 Observed:** Fan cover in walk-in cooler has accumulation of dust or debris. Corrective Action – All fan covers within the walk-in cooler were thoroughly cleaned. Plan of Action – A review will be performed of the regular scheduling of fan cover cleaning throughout the facility and changes will be made accordingly to prevent a reoccurrence of this issue.

**STATE OF FLORIDA**  
**DIVISION OF HOTELS AND RESTAURANTS**  
**DEPARTMENT OF BUSINESS AND PROFESSIONAL REGULATION**  
www.myfloridalicense.com

**Food Service Inspection Report**

This inspection report must be made public upon request per Florida law.

**Met Inspection Standards during this visit**  
**ANY VIOLATIONS noted herein must be corrected by the**  
**NEXT UNANNOUNCED inspection unless otherwise stated.**

Inspection Date:	Jan 20, 2021 10:09 - Jan 20, 2021 12:04	License Expiration:	October 1, 2021
License Number:	2326832 Rank: CATR	Inspection Reason:	Routine - Food
Owner Name:	GREATER MIAMI CATERERS INC	Business Name:	GREATER MIAMI CATERERS INC
Location Address:	4001 NW 31 AVE, /2 BUILDINGS MIAMI FL 33142	License Type:	Catering
Number of Units:	0	Telephone Number:	305-633-4616
		Reinspection on or After:	

**FOODBORNE ILLNESS RISK FACTORS AND PUBLIC HEALTH INTERVENTIONS**

01A Food obtained from approved source	IN	07 Unwrapped or PH/TCS food not re-served	IN
01B Food safe and unadulterated; sound condition	IN	08A Separating raw animal foods from: each other, RTE foods and unwashed produce	IN
01C Shellstock tags; commingling	N/A	08B Food protection during preparation, storage and display	IN
01D Parasite destruction for raw/undercooked fish	N/A	09 Bare hand contact with RTE food; Alternative Operating Procedure (AOP)	IN
02A Consumer advisory on raw/undercooked oysters	N/A	11 Employee health knowledge; ill/symptomatic employee present	IN
02B Consumer advisory on raw/undercooked animal foods	N/A	12A Hands clean and washed properly; use of hand antiseptic if use of AOP	IN
02C Date marking ready-to-eat (RTE) potentially hazardous / time/temperature control for safety foods	IN	12B Employee eating, drinking, tasting food, smoking	IN
03A Receiving and holding PH/TCS foods cold	IN	22 Food-contact surfaces clean and sanitized	IN
03B Receiving and holding PH/TCS foods hot	IN	31A Handwash sink(s) installed, accessible, not used for other purposes	IN
03C Cooking raw animal foods and plant foods; non-continuous cooking of raw animal foods	IN	31B Handwashing supplies and handwash sign provided	IN
03D Cooling PH/TCS foods; proper cooling methods	IN	41 Chemicals/toxic substances	IN
03E Reheating PH/TCS foods for hot holding	N/O	53A Food manager certification; knowledge/active managerial control (except employee health)	IN
03F Time as a Public Health Control	N/A	53B State approved food handler training; employee duty specific training/knowledge	IN
03G Reduced oxygen packaging (ROP) and other Special Processes	N/A		

**GOOD RETAIL PRACTICES**

02D Food items properly labeled; original container		35A No presence or breeding of insects/rodents/pests; no live animals	
04 Facilities to maintain PH/TCS foods at the proper temperature		35B Outer openings protected from insects/pests, rodent proof	
05 Food and food equipment thermometers provided and accurate		36 Floors, walls, ceilings and attached equipment properly constructed and clean; rooms and equipment properly vented	OUT
06 PH/TCS foods properly thawed		38 Lighting provided as required; fixtures shielded or bulbs protected	
10 In use food dispensing utensils properly stored		40 Employee personal belongings	OUT
13 Clean clothes; hair restraints; jewelry; painted/artificial fingernails		42 Cleaning and maintenance equipment	OUT
14 Food-contact and nonfood contact surfaces designed, constructed, maintained, installed, located		43 Complete separation from living/sleeping area/private premise; kitchen restricted - no unauthorized personnel	
16 Dishwashing facilities; chemical test kit(s); gauges 1. Wash 2. Rinse 3. Sanitize		45 Fire extinguishing equipment (FOR REPORTING PURPOSES ONLY)	

**STATE OF FLORIDA**  
**DIVISION OF HOTELS AND RESTAURANTS**  
**DEPARTMENT OF BUSINESS AND PROFESSIONAL REGULATION**  
www.myfloridalicense.com

21	Wiping cloths; clean and soiled linens; laundry facilities		46	Exits not blocked or locked (FOR REPORTING PURPOSES ONLY)	
23	Non-food contact surfaces clean		47	Electrical wiring/outlets in good repair (FOR REPORTING PURPOSES ONLY)	
24	Storage/handling of clean equipment, utensils; air drying		48	Gas appliances; boiler certificate current/posted (FOR REPORTING PURPOSES ONLY)	<b>OUT</b>
25	Single-service and single-use items		49	Flammable/combustible materials (FOR REPORTING PURPOSES ONLY)	
27	Water source safe, hot (100F) and cold under pressure		50	Current license, properly displayed	
28	Sewage and waste water disposed properly		51	Other conditions sanitary and safe operation	
29	Plumbing installed and maintained; mop sink; water filters; backflow prevention	<b>OUT</b>	52	Misrepresentation; misbranding	
32	Bathrooms		54	Florida Clean Indoor Air Act Compliance	
33	Garbage and refuse; premises maintained		55	Automatic Gratuity Notice	

Items marked IN are in compliance. Items marked OUT are violations. Specific details of the violations are listed on subsequent pages. Items marked N/A are Not Applicable. Items marked as N/O are Not Observed and were not being conducted at the time of inspection.

**FOOD TEMPERATURES**

<b>Bar Area</b>	
<b>Buffet Line</b>	
<b>Cook Line</b>	
<b>Front Counter</b>	
<b>Front Line</b>	
<b>Kitchen</b>	white rice (169°F - Hot Holding); cooked roast beef (179°F - Cooking)
<b>Prep Area</b>	cooked broccoli w/ carrots (39°F - Cold Holding); corn meal soup (152°F - Hot Holding); plantains (151°F - Hot Holding); chicken fricassee (152°F - Hot Holding)
<b>Reach In Cooler</b>	
<b>Reach In Freezer</b>	
<b>Steam Table/Bain Marie</b>	
<b>Storage Area</b>	
<b>Wait Station</b>	Delivery Station: shredded lettuce (40°F - Cold Holding); milk (40°F - Cold Holding)
<b>Walk In Cooler</b>	yuca (34°F - Cold Holding); onions w/ peppers (64°F - Cooling from 9:40am, checked 10:30am); soup (34°F - Cold Holding); cooked chicken (32°F - Cold Holding); shredded chicken (84°F - Cooling from 9:55am; checked 10:40am, 2nd temperature 52°F checked at 11:35am); cream cheese (39°F - Cold Holding)
<b>Walk In Freezer</b>	cooked chicken patties (Frozen°F); sliced bread (Frozen°F); baby carrots (Frozen°F); peas and carrots (Frozen°F)

**OTHER ITEMS**

**Certified Food Manager and Date Certified:** Iran G Fumero Morales 11-12-2020  
**Manager Certified By:** 360training.com, Inc. (Learn2Serve)  
**Employees Trained By:** Other Approved Corporate Training  
**Sewage:** Municipal/Utility  
**Water Source:** Municipal  
**Boiler:** No Boiler Certificate Provided  
**Boiler Jurisdiction and Expiration:** 021616: expiration date 11-21-2020

**STATE OF FLORIDA**  
**DIVISION OF HOTELS AND RESTAURANTS**  
**DEPARTMENT OF BUSINESS AND PROFESSIONAL REGULATION**  
[www.myfloridalicense.com](http://www.myfloridalicense.com)

**Sanitizer Details:**

Sanitizer Bucket (Quaternary 200ppm); Dishwasher (Temperature 188°F); Dishwasher (Temperature)

**Inspector Comments:** Joint inspection with senior inspector Hodge.  
Verified ownership with operator.  
Other Approved Training: International Food Service Executives Association  
This is a catering establishment serving food to HSP- accounts (Highly Susceptible Population)

For the most updated and reliable information and guidance regarding COVID-19 in Florida, please visit the Florida Department of Health's dedicated COVID-19 webpage, available at: [www.flhealth.gov/covid19](http://www.flhealth.gov/covid19)

Self-print licenses: the DBPR is transitioning to self-print licenses and will no longer mail out licenses. For more information visit: <http://www.myfloridalicense.com/DBPR/hotels-restaurants/> "

Calibrated Inspectors food probe thermometer and operators food probe thermometer to 32°F during the inspection with the person in charge to ensure accuracy of the thermometer.

Discussed the employee health policy and the "Big 6" foodborne illnesses with the person in charge, when to restrict or excluded employees and proper handwashing procedures.

A link to the Florida Department of Agriculture's Food Recovery Resource Guide is located at: <http://www.myfloridalicense.com/DBPR/hotels-restaurants/forms-publications>

This report has been provided electronically as requested by the person in charge at the time of inspection.

**VIOLATIONS**

**29-34-4 Observed: Vacuum breaker missing at hose bibb or on fitting/splitter added to hose bibb. Observed working hose at the back of the building next to dumpster with no vacuum breaker. Manager add vacuum breaker to hose. \*\*Corrected On-Site\*\***  
Priority: High Priority

**36-27-5 Observed: Wall soiled with accumulated dust. Observed under large kettle pots located at kitchen area.**  
Priority: Basic

**40-06-5 Observed: Employee personal items stored in or above a food preparation area, food, clean equipment and utensils, or single-service items. Observed employee personal purse under prep table at front preparation table, located near front kitchen entrance. Employee purse was removed from preparation area. \*\*Corrected On-Site\*\***  
Priority: Basic

**42-01-4 Observed: Wet mop not stored in a manner to allow the mop to dry. Manager hung map at mop sink at designated area to allow mop to dry. \*\*Corrected On-Site\*\***  
Priority: Basic

**48-01-5 Observed: No current insurance inspector boiler report or boiler certificate available for boiler. For reporting purposes only. Observed expired boiler certificate expired on 11-21-2020 for active boiler, as per The Bureau of fire prevention online portal. Boiler certification not provided or posted at the time of inspection.**

**Observed no carbon monoxide detector located at boiler room.**  
Priority: Reporting



Signature of Recipient

John Butler  
GM  
4001 Nw 31 Ave  
Miami, FL 33142  
7867975528  
Jan 20, 2021 11:51



Inspector Signature

Melisa Aponte Rivera  
Inspector  
8240 NW 52 Terrace, Suite 101  
Doral, FL 33166  
305-629-1882  
Jan 20, 2021 11:49



# Master Host - Greater Miami Caterers, Inc.



LANDMARKS IN THE FOOD SERVICE INDUSTRY

4001 N.W. 31st AVENUE, MIAMI, FLORIDA 33142

(305) 633-8066 • (305) 633-4616 Broward (954) 927 3266 • Fax (305) 635-5202

Web Site: [www.master-host.net](http://www.master-host.net) • E-mail: [info@mhccater.com](mailto:info@mhccater.com) • Alt. Fax (305) 635-0653

## IMMEDIATE CORRECTIVE ACTIONS and PLANS of ACTION to HEALTH DEPARTMENT INSPECTION of 1/20/21

**29-34-4 Observed:** Vacuum breaker missing at hose bibb or on fitting/splitter added to hose bibb. Observed working hose at the back of the building next to dumpster with no vacuum breaker. Corrective Action – The vacuum breaker was immediately reinstalled “Corrected On-Site”. Plan of Action – The sanitation manager advised staff not to remove the vacuum breaker at any time.

**36-27-5 Observed:** Wall soiled with accumulated dust. Observed under large kettle pots located at kitchen area. Corrective Action - The kettle area including the wall and pots was thoroughly cleaned. Plan of Action – The sanitation manager is adjusting his regular cleaning schedule of the area to perform the cleaning with a shorter interval in-between major cleanings.

**40-06-5 Observed:** Employee personal items stored in or above a food preparation area, food, clean equipment and utensils, or single-service items. Observed employee personal purse under prep table at front preparation table, located near front kitchen entrance. Corrective Action – Employee purse was removed from preparation area “Corrected On-Site”. Plan of Action – The sanitation manager advised staff not to leave any personal items in the kitchen area.

**42-01-4 Observed:** Wet mop not stored in a manner to allow the mop to dry. Corrective Action – Manager hung mop at mop sink at designated area to allow mop to dry “Corrected On-Site”. Plan of Action – The sanitation manager advised staff to store the mops as trained in the mop sink area.

**48-01-5 Observed:** No current insurance inspector boiler report or boiler certificate available for boiler. For reporting purposes only. Observed expired boiler certificate on 11-21-2020 for active boiler, as per The Bureau of Fire Prevention online portal. Boiler certification not provided or posted at the time of inspection. Corrective Action – Displayed to inspector that the inspection had occurred on November 23, 2020 through online state portal “Corrected On-Site”. Plan of Action – The invoice pending for \$30 for the renewal of the license was immediately processed. As soon as we receive the new license, it will be posted in the boiler room.

Observed no carbon monoxide detector located at boiler room. Corrective Action – A new one will be purchased and installed within 3 days. Plan of Action – The sanitation manger will add the observation of the detector to his checklist when monitoring the boiler room.

41



**STATE OF FLORIDA**  
**DIVISION OF HOTELS AND RESTAURANTS**  
**DEPARTMENT OF BUSINESS AND PROFESSIONAL REGULATION**  
www.myfloridalicense.com

**Food Service Inspection Report**

This inspection report must be made public upon request per Florida law.

**Met Inspection Standards during this visit**  
**ANY VIOLATIONS noted herein must be corrected by the**  
**NEXT UNANNOUNCED inspection unless otherwise stated.**

Inspection Date:	Sep 16, 2020 09:01 - Sep 16, 2020 11:08	License Expiration:	October 1, 2020
License Number:	2326832 Rank: CATR	Inspection Reason:	Routine - Food
Owner Name:	GREATER MIAMI CATERERS INC	Business Name:	GREATER MIAMI CATERERS INC
Location Address:	4001 NW 31 AVE, /2 BUILDINGS MIAMI FL 33142	License Type:	Catering
Number of Units:	0	Telephone Number:	305-633-4616
		Reinspection on or After:	

**FOODBORNE ILLNESS RISK FACTORS AND PUBLIC HEALTH INTERVENTIONS**

01A Food obtained from approved source	IN	07 Unwrapped or PH/TCS food not re-served	IN
01B Food safe and unadulterated; sound condition	IN	08A Separating raw animal foods from: each other, RTE foods and unwashed produce	IN
01C Shellstock tags; commingling	N/A	08B Food protection during preparation, storage and display	IN
01D Parasite destruction for raw/undercooked fish	N/A	09 Bare hand contact with RTE food; Alternative Operating Procedure (AOP)	IN
02A Consumer advisory on raw/undercooked oysters	N/A	11 Employee health knowledge; ill/symptomatic employee present	IN
02B Consumer advisory on raw/undercooked animal foods	N/A	12A Hands clean and washed properly; use of hand antiseptic if use of AOP	IN
02C Date marking ready-to-eat (RTE) potentially hazardous / time/temperature control for safety foods	IN	12B Employee eating, drinking, tasting food, smoking	IN
03A Receiving and holding PH/TCS foods cold	IN	22 Food-contact surfaces clean and sanitized	IN
03B Receiving and holding PH/TCS foods hot	IN	31A Handwash sink(s) installed, accessible, not used for other purposes	IN
03C Cooking raw animal foods and plant foods; non-continuous cooking of raw animal foods	IN	31B Handwashing supplies and handwash sign provided	OUT
03D Cooling PH/TCS foods; proper cooling methods	N/O	41 Chemicals/toxic substances	IN
03E Reheating PH/TCS foods for hot holding	N/O	53A Food manager certification; knowledge/active managerial control (except employee health)	IN
03F Time as a Public Health Control	N/A	53B State approved food handler training; employee duty specific training/knowledge	IN
03G Reduced oxygen packaging (ROP) and other Special Processes	N/A		

**GOOD RETAIL PRACTICES**

02D Food items properly labeled; original container		35A No presence or breeding of insects/rodents/pests; no live animals	
04 Facilities to maintain PH/TCS foods at the proper temperature		35B Outer openings protected from insects/pests, rodent proof	OUT
05 Food and food equipment thermometers provided and accurate		36 Floors, walls, ceilings and attached equipment properly constructed and clean; rooms and equipment properly vented	OUT
06 PH/TCS foods properly thawed		38 Lighting provided as required; fixtures shielded or bulbs protected	
10 In use food dispensing utensils properly stored		40 Employee personal belongings	
13 Clean clothes; hair restraints; jewelry; painted/artificial fingernails		42 Cleaning and maintenance equipment	
14 Food-contact and nonfood contact surfaces designed, constructed, maintained, installed, located	OUT	43 Complete separation from living/sleeping area/private premise; kitchen restricted - no unauthorized personnel	
16 Dishwashing facilities; chemical test kit(s); gauges 1. Wash 2. Rinse 3. Sanitize		45 Fire extinguishing equipment (FOR REPORTING PURPOSES ONLY)	

**STATE OF FLORIDA**  
**DIVISION OF HOTELS AND RESTAURANTS**  
**DEPARTMENT OF BUSINESS AND PROFESSIONAL REGULATION**  
www.myfloridalicense.com

21 Wiping cloths; clean and soiled linens; laundry facilities		46 Exits not blocked or locked (FOR REPORTING PURPOSES ONLY)	
23 Non-food contact surfaces clean		47 Electrical wiring/outlets in good repair (FOR REPORTING PURPOSES ONLY)	
24 Storage/handling of clean equipment, utensils; air drying		48 Gas appliances; boiler certificate current/posted (FOR REPORTING PURPOSES ONLY)	
25 Single-service and single-use items		49 Flammable/combustible materials (FOR REPORTING PURPOSES ONLY)	
27 Water source safe, hot (100F) and cold under pressure		50 Current license, properly displayed	
28 Sewage and waste water disposed properly		51 Other conditions sanitary and safe operation	
29 Plumbing installed and maintained; mop sink; water filters; backflow prevention		52 Misrepresentation; misbranding	
32 Bathrooms		54 Florida Clean Indoor Air Act Compliance	
33 Garbage and refuse; premises maintained		55 Automatic Gratuity Notice	

Items marked IN are in compliance. Items marked OUT are violations. Specific details of the violations are listed on subsequent pages. Items marked N/A are Not Applicable. Items marked as N/O are Not Observed and were not being conducted at the time of inspection.

**FOOD TEMPERATURES**

Bar Area	
Buffet Line	
Cook Line	beef stew w/ potatoes (194°F - Cooking); black beans w/ rice (184°F - Cooking)
Front Counter	
Front Line	
Kitchen	baked chicken (174°F - Hot Holding)
Prep Area	mixed vegetables (160°F - Hot Holding); imperial rice (149°F - Hot Holding); chicken cordon bleu (158°F - Hot Holding); oriental rice (141°F - Hot Holding); yellow rice w/ chicken (155°F - Hot Holding)
Reach In Cooler	
Reach In Freezer	
Steam Table/Bain Marie	
Storage Area	
Wait Station	Delivery: plantains (148°F - Hot Holding); peas (156°F - Hot Holding)
Walk In Cooler	white rice (126°F - Cooling 9:35am;checked 9:52am); shredded chicken (39°F - Cold Holding); cooked ground beef (41°F - Cold Holding); shredded pork (39°F - Cold Holding); watermelon (60°F - Cooling); lentil soup (96°F - Cooling); swai filets (43°F - Cold Holding); split pea soup (47°F - Cooling 8am; checked 10am); marinated raw vegetables pork chops (41°F - Cold Holding); mash potatoes (101°F - Cooling)
Walk In Freezer	lentil soup (Frozen°F); turkey meatballs w/ roasted potatoes (Frozen°F); beef stew w/ vegetables (Frozen°F)

**OTHER ITEMS**

**Certified Food Manager and Date Certified:** Iran G Fumero Morales 11/16/2015  
**Manager Certified By:** 360training.com, Inc. (Learn2Serve)  
**Employees Trained By:** Other Approved Corporate Training  
**Sewage:** Municipal/Utility  
**Water Source:** Municipal  
**Boiler:** No Boiler On Site  
**Boiler Jurisdiction and Expiration:**

**STATE OF FLORIDA**  
**DIVISION OF HOTELS AND RESTAURANTS**  
**DEPARTMENT OF BUSINESS AND PROFESSIONAL REGULATION**  
[www.myfloridalicense.com](http://www.myfloridalicense.com)

**Sanitizer Details:**

Sanitizer Bucket (Quaternary 200ppm); Dishwasher (Temperature 190°F)

**Inspector Comments:** Ownership verified.  
Other Approved Training: International Food Service Executives Association  
This is a catering establishment serving food to HSP-accounts (Highly Susceptible Population)

swai filets (43°F - Cold Holding), cart of swai filets were moved by manager into walk in freezer to lower temperatures to 41°F and below.

Calibrated Inspectors food probe thermometer and operators food probe thermometer to +/- 32°F during the inspection with the person in charge to ensure accuracy of the thermometer.

Discussed the employee health policy and the "big 5" foodborne illnesses with the person in charge, when to restrict or excluded employees and proper handwashing procedures.

Discussed with the operator the requirements that employees must be screened prior to every shift, which is being conducted with daily temperature checks and screening questions. Provided "Responding to COVID-19 in the Workplace" flyer from the Florida Department of Health. This includes updated employee screening protocol.

Hand sinks must be operational and accessible with hot and cold water, soap, paper towels and Employees hand washing sign. Employees must be washing their hands as required.

For the most updated and reliable information and guidance regarding COVID-19 and executive orders in Florida, please visit the Florida Department of Health's dedicated COVID-19 webpage, available at: [www.flhealth.gov/covid19](http://www.flhealth.gov/covid19)

Discussed with operator to promote frequent and thorough hand washing, as well as, providing workers & customers, with alcohol-based hand rubs containing at least 60% alcohol. Encourage respiratory etiquette, such as wearing face masks and practice social distancing.

A link to the Florida Department of Agriculture's Food Recovery Resource Guide is located at:  
<http://www.myfloridalicense.com/DBPR/hotels-restaurants/forms-publications>

**This report has been provided electronically as requested by the person in charge at the time of inspection.**

**VIOLATIONS**

**14-10-4 Observed: Equipment or utensils not designed or constructed in a durable manner. Observed dented metal strainers located at kitchen cookline.**  
Priority: Basic

**31B-04-4 Observed: No handwashing sign provided at a hand sink used by food employees located near dish machine. Manager posted handwash sign at handwash sink. \*\*Corrected On-Site\*\***  
Priority: Basic

**35B-01-4 Observed: Exterior door has a gap at the threshold that opens to the outside located towards back kitchen area.**  
Priority: Basic

**36-57-4 Observed: Ceiling fan had accumulation of dust/debris located at middle kitchen area.**  
Priority: Basic



Signature of Recipient  
  
John Butler  
Manager  
305.633.8066  
Sep 16, 2020 11:08



Inspector Signature  
  
Kristen Hodge  
Senior Sanitation & Safety Specialist  
8240 NW 52nd Terrace  
Doral, FL 33166  
850.487.1395  
Sep 16, 2020 10:46



# Master Host • Greater Miami Caterers, Inc.



LANDMARKS IN THE FOOD SERVICE INDUSTRY

4001 N.W. 31st AVENUE, MIAMI, FLORIDA 33142

(305) 633-8066 • (305) 633-4616 Broward (954) 927 3266 • Fax (305) 635-5202

Web Site: [www.master-host.net](http://www.master-host.net) • E-mail: [info@mhccater.com](mailto:info@mhccater.com) • Alt. Fax (305) 635-0653

## IMMEDIATE CORRECTIVE ACTIONS and PLANS of ACTION to HEALTH DEPARTMENT INSPECTION of 9/16/20

**14-10-4 Observed:** Equipment or utensils not designed or constructed in a durable manner. Observed dented metal strainers located at kitchen cookline. Corrective Action – The metal strainers used to keep the floor drains from getting clogged were dented. The strainers were disposed of upon inspection. Plan of Action – New strainers were ordered and will be replaced more frequently as they continue to become dented.

**31B-04-4 Observed:** No handwashing sign provided at a hand sink used by food employees located near dish machine. Manager posted handwash sign at handwash sink. Corrective Action – The handwash sign was immediately posted on site “Corrected On-Site”. Plan of Action – Although a handwash sign had previously been posted at that location, it was no longer there. The sanitation manager will review the monitoring schedule to make sure the signs are replaced when removed.

**35B-01-4 Observed:** Exterior door has a gap at the threshold that opens to the outside located towards back kitchen area. Corrective Action – The door sweep installed will be immediately replaced with a new sweep so that the gap is filled. Plan of Action – The sanitation manager will review the monitoring schedule to make sure the wear and tear on the door sweep is observed so that the sweep is replaced upon identification of a gap.

**36-57-4 Observed:** Ceiling fan had accumulation of dust/debris located at middle kitchen area. Corrective Action - The fan identified was immediately cleaned. Plan of Action – The sanitation manager is adjusting his regular cleaning schedule of the fans to perform the cleaning with a shorter interval in between cleanings.

**D- 4**

Tab D-4

46

Ron DeSantis, Governor

Halsey Beshears, Secretary

STATE OF FLORIDA  
DEPARTMENT OF BUSINESS AND PROFESSIONAL REGULATION  
DIVISION OF HOTELS AND RESTAURANTS

LICENSE NUMBER: CAT2326832

EXPIRATION DATE: OCTOBER 1, 2021

THE CATERER (2013) HEREIN IS LICENSED UNDER THE  
PROVISIONS OF CHAPTER 509, FLORIDA STATUTES

GREATER MIAMI CATERERS INC  
GREATER MIAMI CATERERS INC  
4001 NW 31 AVE  
/2 BUILDINGS  
MIAMI FL 33142



ISSUED: 09/23/2020

Always verify licenses online at MyFloridaLicense.com

Do not alter this document in any form.

This is your license. It is unlawful for anyone other than the licensee to use this document.

000030

Local Business Tax Receipt

Miami-Dade County, State of Florida

-THIS IS NOT A BILL - DO NOT PAY



3550978

BUSINESS NAME/LOCATION

GREATER MIAMI CATERERS INC  
4001 NW 31ST AVE  
MIAMI FL 33142

RECEIPT NO.

RENEWAL  
1070499

EXPIRES

SEPTEMBER 30, 2021

Must be displayed at place of business  
Pursuant to County Code  
Chapter 8A - Art. 9 & 10



OWNER

GREATER MIAMI CATERERS INC

SEC. TYPE OF BUSINESS

195 CATERING BUSINESS  
CAT2326832

PAYMENT RECEIVED  
BY TAX COLLECTOR

\$75.00 07/27/2020  
CHECK21-20-063861

Employee(s) 5

This Local Business Tax Receipt only confirms payment of the Local Business Tax. The Receipt is not a license, permit, or a certification of the holder's qualifications to do business. Holder must comply with any governmental or nongovernmental regulatory laws and requirements which apply to the business.

The RECEIPT NO. above must be displayed on all commercial vehicles - Miami-Dade Code Sec 8a-276.

For more information, visit [www.miamidade.gov/taxcollector](http://www.miamidade.gov/taxcollector)



# CERTIFICATE OF LIABILITY INSURANCE

DATE (MM/DD/YYYY)  
6/7/2021

THIS CERTIFICATE IS ISSUED AS A MATTER OF INFORMATION ONLY AND CONFERS NO RIGHTS UPON THE CERTIFICATE HOLDER. THIS CERTIFICATE DOES NOT AFFIRMATIVELY OR NEGATIVELY AMEND, EXTEND OR ALTER THE COVERAGE AFFORDED BY THE POLICIES BELOW. THIS CERTIFICATE OF INSURANCE DOES NOT CONSTITUTE A CONTRACT BETWEEN THE ISSUING INSURER(S), AUTHORIZED REPRESENTATIVE OR PRODUCER, AND THE CERTIFICATE HOLDER.

**IMPORTANT:** If the certificate holder is an ADDITIONAL INSURED, the policy(ies) must be endorsed. If SUBROGATION IS WAIVED, subject to the terms and conditions of the policy, certain policies may require an endorsement. A statement on this certificate does not confer rights to the certificate holder in lieu of such endorsement(s).

<b>PRODUCER</b> Keyes Coverage Insurance 5900 Hiatus Road Tamarac FL 33321	<b>CONTACT NAME:</b> Vanessa Marcano <b>PHONE (A/C, No, Ext):</b> 954-724-7000 <b>E-MAIL ADDRESS:</b> vmarcano@keyescor.com	<b>FAX (A/C, No):</b>
	<b>INSURER(S) AFFORDING COVERAGE</b>	
<b>INSURED</b> Greater Miami Caterers, Inc Master Host Dinner Service 4001 NW 31st Avenue Miami FL 33142	<b>INSURER A :</b> Allied Property & Casualty Ins Co	<b>NAIC #</b> 42579
	<b>INSURER B :</b> Nat'l Union Fire of Pittsburgh	<b>NAIC #</b> 19445
	<b>INSURER C :</b> Ascendant Commercial Insurance	<b>NAIC #</b> 13683
	<b>INSURER D :</b>	
	<b>INSURER E :</b>	
	<b>INSURER F :</b>	

**COVERAGES**                      **CERTIFICATE NUMBER:** 64608093                      **REVISION NUMBER:**

THIS IS TO CERTIFY THAT THE POLICIES OF INSURANCE LISTED BELOW HAVE BEEN ISSUED TO THE INSURED NAMED ABOVE FOR THE POLICY PERIOD INDICATED. NOTWITHSTANDING ANY REQUIREMENT, TERM OR CONDITION OF ANY CONTRACT OR OTHER DOCUMENT WITH RESPECT TO WHICH THIS CERTIFICATE MAY BE ISSUED OR MAY PERTAIN, THE INSURANCE AFFORDED BY THE POLICIES DESCRIBED HEREIN IS SUBJECT TO ALL THE TERMS, EXCLUSIONS AND CONDITIONS OF SUCH POLICIES. LIMITS SHOWN MAY HAVE BEEN REDUCED BY PAID CLAIMS.

INSR LTR	TYPE OF INSURANCE	ADDL INSD	SUBR WVD	POLICY NUMBER	POLICY EFF (MM/DD/YYYY)	POLICY EXP (MM/DD/YYYY)	LIMITS	
A	<input checked="" type="checkbox"/> <b>COMMERCIAL GENERAL LIABILITY</b> <input type="checkbox"/> CLAIMS-MADE <input checked="" type="checkbox"/> OCCUR  GEN'L AGGREGATE LIMIT APPLIES PER: <input checked="" type="checkbox"/> POLICY <input type="checkbox"/> PROJECT <input type="checkbox"/> LOC OTHER:	Y	Y	ACPLP03019431511	10/3/2020	10/3/2021	EACH OCCURRENCE	\$ 1,000,000
							DAMAGE TO RENTED PREMISES (Ea occurrence)	\$ 100,000
							MED EXP (Any one person)	\$ 5,000
							PERSONAL & ADV INJURY	\$ 1,000,000
							GENERAL AGGREGATE	\$ 2,000,000
							PRODUCTS - COMP/OP AGG	\$ 2,000,000
								\$
C	<b>AUTOMOBILE LIABILITY</b>  <input type="checkbox"/> ANY AUTO ALL OWNED AUTOS <input checked="" type="checkbox"/> HIRED AUTOS <input checked="" type="checkbox"/> SCHEDULED AUTOS NON-OWNED AUTOS			CA-53469-0	10/3/2020	10/3/2021	COMBINED SINGLE LIMIT (Ea accident)	\$ 2,000,000
							BODILY INJURY (Per person)	\$
							BODILY INJURY (Per accident)	\$
							PROPERTY DAMAGE (Per accident)	\$
								\$
B	<input checked="" type="checkbox"/> <b>UMBRELLA LIAB</b> <input checked="" type="checkbox"/> OCCUR <input type="checkbox"/> EXCESS LIAB <input type="checkbox"/> CLAIMS-MADE  DED    RETENTION \$			EBU015476235	10/3/2020	10/3/2021	EACH OCCURRENCE	\$ 1,000,000
							AGGREGATE	\$
							Over GL Only	\$
	<b>WORKERS COMPENSATION AND EMPLOYERS' LIABILITY</b> ANY PROPRIETOR/PARTNER/EXECUTIVE OFFICER/MEMBER EXCLUDED? (Mandatory in NH) If yes, describe under DESCRIPTION OF OPERATIONS below		Y/N	N/A			PER STATUTE	OTH-ER
							E.L. EACH ACCIDENT	\$
							E.L. DISEASE - EA EMPLOYEE	\$
							E.L. DISEASE - POLICY LIMIT	\$

DESCRIPTION OF OPERATIONS / LOCATIONS / VEHICLES (ACORD 101, Additional Remarks Schedule, may be attached if more space is required)  
RE: CITY OF MIAMI SPRINGS, REQUEST FOR PROPOSALS NO. 01-20/21  
Certificate Holder is included as an additional insured with respects to General Liability when required by written contract

<b>CERTIFICATE HOLDER</b>  City of Miami Springs 201 Westward Drive Miami Springs FL 33166	<b>CANCELLATION</b> 30 Days Notice / 10 Days for Non-Pay  SHOULD ANY OF THE ABOVE DESCRIBED POLICIES BE CANCELLED BEFORE THE EXPIRATION DATE THEREOF, NOTICE WILL BE DELIVERED IN ACCORDANCE WITH THE POLICY PROVISIONS.  AUTHORIZED REPRESENTATIVE 
--	---



# CERTIFICATE OF LIABILITY INSURANCE

DATE (MM/DD/YYYY)

06/07/2021

THIS CERTIFICATE IS ISSUED AS A MATTER OF INFORMATION ONLY AND CONFERS NO RIGHTS UPON THE CERTIFICATE HOLDER. THIS CERTIFICATE DOES NOT AFFIRMATIVELY OR NEGATIVELY AMEND, EXTEND OR ALTER THE COVERAGE AFFORDED BY THE POLICIES BELOW. THIS CERTIFICATE OF INSURANCE DOES NOT CONSTITUTE A CONTRACT BETWEEN THE ISSUING INSURER(S), AUTHORIZED REPRESENTATIVE OR PRODUCER, AND THE CERTIFICATE HOLDER.

**IMPORTANT:** If the certificate holder is an **ADDITIONAL INSURED**, the policy(ies) must have **ADDITIONAL INSURED** provisions or be endorsed. If **SUBROGATION IS WAIVED**, subject to the terms and conditions of the policy, certain policies may require an endorsement. A statement on this certificate does not confer rights to the certificate holder in lieu of such endorsement(s).

<b>PRODUCER</b> Risk Transfer Insurance Agency, LLC 47 E. Robinson Street Suite 200 Orlando, FL 32801	<b>CONTACT NAME:</b> Certificates
	<b>PHONE (A/C, No, Ext):</b> _____ <b>FAX (A/C, No):</b> _____ <b>E-MAIL ADDRESS:</b> Certificates@kymberlygroup.com
<b>INSURER(S) AFFORDING COVERAGE</b>	
INSURER A :Service American Indemnity Company	NAIC # 39152
INSURER B :	
INSURER C :	
INSURER D :	
INSURER E :	
INSURER F :	

**INSURED**  
 Kymerly Group Payroll Solutions, Inc.  
 1 W. Church Street, 2nd Floor, Suite 200  
 Orlando, FL 32801

**COVERAGES**

CERTIFICATE NUMBER: Z2NCR6EJ

REVISION NUMBER:

THIS IS TO CERTIFY THAT THE POLICIES OF INSURANCE LISTED BELOW HAVE BEEN ISSUED TO THE INSURED NAMED ABOVE FOR THE POLICY PERIOD INDICATED. NOTWITHSTANDING ANY REQUIREMENT, TERM OR CONDITION OF ANY CONTRACT OR OTHER DOCUMENT WITH RESPECT TO WHICH THIS CERTIFICATE MAY BE ISSUED OR MAY PERTAIN, THE INSURANCE AFFORDED BY THE POLICIES DESCRIBED HEREIN IS SUBJECT TO ALL THE TERMS, EXCLUSIONS AND CONDITIONS OF SUCH POLICIES. LIMITS SHOWN MAY HAVE BEEN REDUCED BY PAID CLAIMS.

INSR LTR	TYPE OF INSURANCE	ADDL SUBR INSD WVD	POLICY NUMBER	POLICY EFF (MM/DD/YYYY)	POLICY EXP (MM/DD/YYYY)	LIMITS
	<b>COMMERCIAL GENERAL LIABILITY</b> <input type="checkbox"/> CLAIMS-MADE <input type="checkbox"/> OCCUR  GEN'L AGGREGATE LIMIT APPLIES PER: <input type="checkbox"/> POLICY <input type="checkbox"/> PRO-JECT <input type="checkbox"/> LOC OTHER: _____					EACH OCCURRENCE \$ DAMAGE TO RENTED PREMISES (Ea occurrence) \$ MED EXP (Any one person) \$ PERSONAL & ADV INJURY \$ GENERAL AGGREGATE \$ PRODUCTS - COMP/OP AGG \$
	<b>AUTOMOBILE LIABILITY</b> <input type="checkbox"/> ANY AUTO <input type="checkbox"/> OWNED AUTOS ONLY <input type="checkbox"/> SCHEDULED AUTOS <input type="checkbox"/> HIRED AUTOS ONLY <input type="checkbox"/> NON-OWNED AUTOS ONLY					COMBINED SINGLE LIMIT (Ea accident) \$ BODILY INJURY (Per person) \$ BODILY INJURY (Per accident) \$ PROPERTY DAMAGE (Per accident) \$
	<b>UMBRELLA LIAB</b> <input type="checkbox"/> OCCUR <b>EXCESS LIAB</b> <input type="checkbox"/> CLAIMS-MADE DED _____ RETENTION \$ _____					EACH OCCURRENCE \$ AGGREGATE \$
A	<b>WORKERS COMPENSATION AND EMPLOYERS' LIABILITY</b> ANY PROPRIETOR/PARTNER/EXECUTIVE OFFICER/MEMBER EXCLUDED? (Mandatory in NH) If yes, describe under DESCRIPTION OF OPERATIONS below	Y/N <input type="checkbox"/> N/A	RT21MWC6690005303	01/01/2021	01/01/2022	<input checked="" type="checkbox"/> PER STATUTE <input type="checkbox"/> OTHER E.L. EACH ACCIDENT \$ 1,000,000 E.L. DISEASE - EA EMPLOYEE \$ 1,000,000 E.L. DISEASE - POLICY LIMIT \$ 1,000,000

**DESCRIPTION OF OPERATIONS / LOCATIONS / VEHICLES** (ACORD 101, Additional Remarks Schedule, may be attached if more space is required)  
 Coverage is extended to the leased employees of alternate employer in all states except in monopolistic states (ND, OH, WA, WY): Greater Miami Caterers, Inc. (Added Effective: 12/28/20)

**CERTIFICATE HOLDER**

City of Miami Springs  
 201 Westward Drive  
 Miami Springs, FL 33166

**CANCELLATION**

SHOULD ANY OF THE ABOVE DESCRIBED POLICIES BE CANCELLED BEFORE THE EXPIRATION DATE THEREOF, NOTICE WILL BE DELIVERED IN ACCORDANCE WITH THE POLICY PROVISIONS.

AUTHORIZED REPRESENTATIVE

49



**No supporting firms, contractors, or  
sub-contractors for this project**

D- 5

Tab D-5

**TAB D.**

5. Contractor shall provide a list of current and past clients, with emphasis on Florida municipalities.

Miami Dade County	Rani Panchnathan (786) 469-4789 <u>Rani.Panchanathan@miamidade.gov</u>	07/01/2019
Little Havana Activities & Nutrition Centers of Miami Dade	Betty Ruano-Bond (786-234-6524 <u>Betty.Ruano@lhanc.org</u>	10/01/2018
Hialeah Housing Authority	Ileana Sanabria (305) 888-9744 <u>ISanabria@hialeahhousing.org</u>	04/01/2018
South West Social Service	Mario Mendez (305) 218-1667 <u>mmendez@southwestsocial.org</u>	07/17/2017
City of West Miami	Yolanda Aguilar (305) 263-8900 <u>YolandaAguilar@cityofwestmiami.org</u>	10/01/2015
North Miami Foundation	Debbie Kleinberg (305) 893-1450 <u>dk@nmf620.org</u>	04/01/2018
City of South Miami	Maria Menendez/ Ana Lazarbal (305) 668-3863 <u>ALarzabal@southmiamifl.gov</u>	06/20/2017

D- 6

Tab D-6



1:37:13 PM 08/20/2021

**Complaint Details**

Below is a listing of public complaints regarding the person or entity selected. This may not reflect all public complaints filed with the Department; for example, all complaints against Community Association Managers (CAMs) are available to the public, regardless of whether any appear below, and may be requested directly from the Department. The Department is also precluded from disclosing any complaints which are confidential pursuant to Florida Statutes. If you would like a full list of public complaints against an individual or entity or to make a public records request for complaints listed please visit our **Public Records page**.

You can search for public records pertaining to unlicensed activity complaints through an additional database by visiting our **Search Unlicensed Activity Complaints page**. For more information about CAM complaints, please visit the **CAMS page**.

Name: GREATER MIAMI CATERERS INC

The Status and Discipline Description below is only the status of a complaint. To see the status of this license select the "Back" button to return to the License Details Screen.

License No.	Class	Discipline Description	Discipline Date	Disposition	Disposition Date	Status	Conditions of FO Satisfied
2019026913	Administrative Complaint		07/10/2019	Admin Fines For Food Service	07/10/2019	Closed	Correct Violations
2018047356	Consumer Complaint		09/07/2018	Insp Performed- Allegation Not Observed	09/13/2018	Closed	

2601 Blair Stone Road, Tallahassee FL 32309 :: Email: Customer Contact Center :: Customer Contact Center: 850.487.1395

The State of Florida is an AA/EEO employer. Copyright 2007-2010 State of Florida. Privacy Statement

Under Florida law, email addresses are public records. If you do not want your email address released in response to a public records request, do not send electronic mail to this entity. Instead, contact the office by phone or by traditional mail. If you have any questions, please contact 850.487.1395. Pursuant to Section 455.225(1), Florida Statutes, effective October 1, 2012, licensees licensed under Chapter 455, F.S. must provide the Department with an email address if they have one. The email provided may be used for official communication with the licensee. However, email addresses are public record. If you do not wish to supply a personal address, please provide the Department with an email address which can be made available to the public.

D-7

Tab D-7

55



# Master Host • Greater Miami Caterers, Inc.

LANDMARKS IN THE FOOD SERVICE INDUSTRY

4001 N.W. 31st AVE., MIAMI, FLORIDA 33142 • P.O. BOX 520752, MIAMI, FLORIDA 33152  
(305) 633-8066 • (305) 633-4616 • Broward (954) 927-3266 • Fax (305) 635-5202



## BIOGRAPHY

Greater Miami Caterers, inc. (herein referred to as "GMC") was established in 1968 by Mr. David A. Butler. Over time, the company grew steadily year in and year out serving dignitaries to debutantes throughout Dade and Broward counties. This growth continued to the point where Mr. Butler was able to buy out his major retail competitor, Master Host Caterers in 1988. Unfortunately Mr. Butler passed away in early 1990 from kidney failure and was not able to participate in GMC's greatest successes in the 90's & 2000's. He was succeeded by his wife and brother-in-law who have both been active in the company for over Forty years. Our corporate structure is centralized and has only one location.

GMC's clientele base function in many different areas in need of catered food services. GMC originally served the "Master Host Dinner Service" to residences, meals to cafeterias and residential living centers, then transitioned into meals to adult and child schools and day care institutions, home-bound and congregate elderly meals-on-wheels. With the growth of elderly meals, child care & charter school meal programs, we found the need to consolidate our services and have eliminated all other product lines.

Through our financial success and viability, GMC has participated in numerous community events for the greater welfare of the public needs. GMC finds its goals to be similar to many other businesses that are family oriented, to produce a consistent product that maintains a high standard and reputation in the community at a reasonable price. We feel that our personal attention to every meal that leaves our kitchen separates us from our competitors and keeps our many longtime customers (some over twenty-five years) coming back for more.

GMC generates all sales in Dade and Broward counties. Our production processes, on a daily basis, produce an average of over twenty thousand meals. Meal types range from bulk child and elderly feeding sites to individualized meals to the elderly. The ability, production processes and expertise presently existing in GMC are positioned like no other competitor in our field.

GMC has only two corporate officers: 1) Jacqueline Butler, President, Secretary and Treasurer and 2) John Olmo, Vice-President. Mr. Olmo is the contacting liaison for most sales. His experience consists of a bachelors degree in business administration and over forty-two years of employment with GMC in all capacities. Namely driver, route supervisor, buyer, personnel director and finally general manager and part owner. Mrs. Butler has a bachelors degree in finance and as well has over forty years experience in the operations of GMC.

GMC has many references on which to draw upon to support all of its statements made here. All references can attest to our ability in the catering field.

GMC has on file an active affirmative action plan which can support GMC's efforts to

enhance minority participation in Dade County through its hiring and purchasing practices. In fact, GMC is recognized and qualifies as a minority vendor under the guidelines established by the U.S. Small Business administration as a female and Hispanic owned small business.

GMC transacts its business in a facility of 11,500 sq. Ft. plus one added warehouses/offices building of 6,000 sq. Ft. which includes offices (2,000 sq. Ft.), food preparation areas (8,000 sq. Ft.), refrigeration (1,900 sq. Ft.) and dry goods storage (4,000 sq. Ft.). Over the past twenty five years, we have invested over \$1,000,000.00 in the replacement and refurbishment of the equipment and facility. Production has been determined to be at 50% capacity of the facility.

GMC has a record of quality service going back to 1968. Through a dedication to quality service and competitive pricing, we have been growing daily since our doors opened. The majority of our client gains are strictly through word of mouth recommendations. We have relationships with clients that span over thirty years.



## Resume:

John Olmo

318 SW 163 Ave., Pembroke Pines, Fl. 33027

[jolmo@gmccater.com](mailto:jolmo@gmccater.com)

786-797-5529

### Work Experience –

Vice-President

Greater Miami Caterers, Inc.

March 1977 to present

### Education –

Batchelor's of Business Administration

University of Miami

1982

High School Diploma

Miami Springs Senior High

1977

### Skills –

Kitchen Management

Institutional Food Preparation

Menu Planning

Recipe Formulation

NSLP Certified

Facilities Management

Shipping Coordination

Office Administration

Human Resources

Accounts Payables

Accounts Receivables

Payroll

Accounting

Quickbooks & MS Office

Proprietary Pick & ES

**D- 8**

Tab D-8

**CITY OF MIAMI SPRINGS  
REQUEST FOR PROPOSALS NO. 01-20/21**

**FORM 8  
KEY STAFF & PROPOSED SUBCONTRACTORS**

**KEY STAFF**

Please complete the following chart with the Firm's proposed Key Staff. If additional space is required, please copy/duplicate this page and attach to this Form. Additional space:  No  Yes

Name	Title	Years of Experience	Years with Firm	Licenses/Certifications
Jackie Butler	President	46	46	
John Olmo	Vice-President	44	44	
John Butler	General Manager	17	17	
Abraham Ramos	Shipping Supervisor	6	6	
Jose Lopez	Executive Head Chef	27	27	
Stephanie Visi	Elderly Service Coordinator	10	10	
Luis Porras	Administrator Assistant / Elderly Serv. Coordinator	14	14	
Jose Ramirez	Lead Data Clerk	8	8	
Wilson Elivo	Assistant chef.	5	5	

Please explain the Firm's ability and resources to substitute personnel with equal or higher qualifications than the Key Staff they will substitute for where substitute is required due to attrition, turnover, or a specific request by the City:

Staff shortage – GMC has not arrived to where it is today without having to respond to this problem nearly on a daily basis. All managers and assistant managers are capable of performing any and all line positions throughout our operation. If a driver calls in sick, the route is most often broken up into 2 or 3 parts so that it is accomplished within normal time standards. If any cook or food handler is out sick, staff redundancies with managerial supervision easily absorb the workload of their missing coworker. In addition, the major portion of our staff lives very near to our facility. Therefore during hurricane emergencies they are often called back in to meet the obligations GMC has to critical service providers that depend on our services to feed their work crews while they are restoring services to the residents of Miami-Dade County.

## **Project Team/Personnel Qualifications**

Tab E

**E- 1**

**Tab E-1**

62

**CITY OF MIAMI SPRINGS  
REQUEST FOR PROPOSALS NO. 01-20/21**

**FORM 8  
KEY STAFF & PROPOSED SUBCONTRACTORS**

**KEY STAFF**

Please complete the following chart with the Firm's proposed Key Staff. If additional space is required, please copy/duplicate this page and attach to this Form. Additional space:  No  Yes

Name	Title	Years of Experience	Years with Firm	Licenses/Certifications
Jackie Butler	President	46	46	
John Olmo	Vice-President	44	44	
John Butler	General Manager	17	17	
Abraham Ramos	Shipping Supervisor	6	6	
Jose Lopez	Executive Head Chef	27	27	
Stephanie Visi	Elderly Service Coordinator	10	10	
Luis Porras	Administrator Assistant / Elderly Serv. Coordinator	14	14	
Jose Ramirez	Lead Data Clerk	8	8	
Wilson Elivo	Assistant chef.	5	5	

Please explain the Firm's ability and resources to substitute personnel with equal or higher qualifications than the Key Staff they will substitute for where substitute is required due to attrition, turnover, or a specific request by the City:

Staff shortage – GMC has not arrived to where it is today without having to respond to this problem nearly on a daily basis. All managers and assistant managers are capable of performing any and all line positions throughout our operation. If a driver calls in sick, the route is most often broken up into 2 or 3 parts so that it is accomplished within normal time standards. If any cook or food handler is out sick, staff redundancies with managerial supervision easily absorb the workload of their missing coworker. In addition, the major portion of our staff lives very near to our facility. Therefore during hurricane emergencies they are often called back in to meet the obligations GMC has to critical service providers that depend on our services to feed their work crews while they are restoring services to the residents of Miami-Dade County.

**CITY OF MIAMI SPRINGS  
REQUEST FOR PROPOSALS NO. 01-20/21**

Please identify each Key Staff member's engagement commitments that will exist concurrently with the City's Services:

Key Staff Name	Area of Responsibility	Client	Commitment (Hours/week)	Period of Engagement
Employees do not sign engagement agreements, therefore none are committed for any time period.				

**PROPOSED SUBCONTRACTORS**

The undersigned Respondent hereby designates, as follows, all major subcontractors whom they propose to utilize for the major areas of work for the services. The bidder is further notified that all subcontractors shall be properly licensed, bondable, and shall be required to furnish the City with a Certificate of Insurance in accordance with the contract general conditions. Failure to furnish this information shall be grounds for rejection of the bidder's proposal. (If no subcontractors are proposed, state "None" on first line below.)

Subcontractor Name & Address	Scope of Work	License Number
N/A		

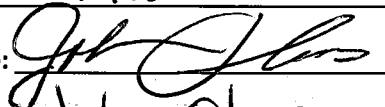
Firm: Greater Miami Caterers, Inc.  
 Authorized Signature:  Date: 6/10/21  
 Print or Type Name: John Olmo Title: Vice-President

E- 2

Tab E-2

65





## SUPPORT STAFFING CHART “Project Team”

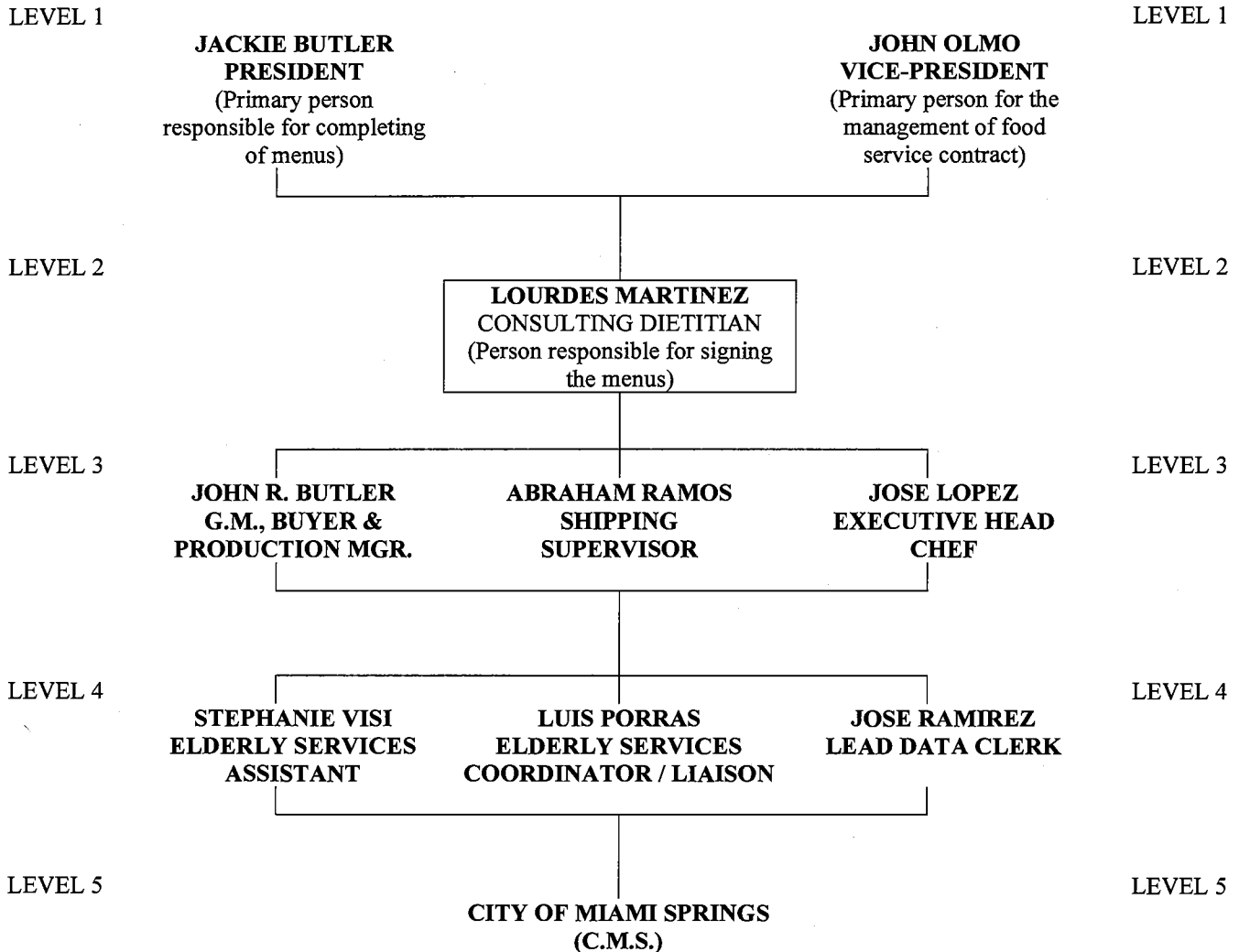

- LEVEL 1 PRINCIPLE OFFICERS, HANDLE ALL CORPORATE DECISION MAKING.
- LEVEL 2 STAFF PERSON, PROVIDES CONSULTATION ON ALL DIETETIC FUNCTIONS OF FOOD SERVICES.
- LEVEL 3 LINE PERSONNEL, THEY HANDLE ALL FACETS OF PURCHASING, PRODUCTION AND SHIPPING.
- LEVEL 4 STAFF PERSONNEL, THEY HANDLE ALL DAY TO DAY TRANSACTIONS FOR HOME-BOUND MEAL SERVICES.

ALL NON DIETETIC STAFF ARE FULLTIME AND PERMANENT EMPLOYEES  
STATEMENT – NO NEW POSITIONS ARE PROPOSED TO MEET THE REQUIREMENTS OF THIS CONTRACT.

66

**E-3**

Tab E-3

67

## Resume:

John Olmo  
318 SW 163 Ave., Pembroke Pines, Fl. 33027  
[jolmo@gmccater.com](mailto:jolmo@gmccater.com)  
786-797-5529

### Work Experience –

Vice-President  
Greater Miami Caterers, Inc.  
March 1977 to present

### Education –

Batchelor's of Business Administration  
University of Miami  
1982

High School Diploma  
Miami Springs Senior High  
1977

### Skills –

Kitchen Management  
Institutional Food Preparation  
Menu Planning  
Recipe Formulation  
NSLP Certified  
Facilities Management  
Shipping Coordination  
Office Administration  
Human Resources  
Accounts Payables  
Accounts Receivables  
Payroll  
Accounting  
Quickbooks & MS Office  
Proprietary Pick & ES



---

Manuel Marrero <i>Chairman</i>	Rafael Iglesias <i>President and CEO</i>	Mario Luis del Valle <i>Vice Chair</i>	Lourdes M. Madariaga <i>Treasurer</i>	Luis M. Borges <i>Secretary</i>	Alberto Balido <i>Director</i>	Elisa De Velasco <i>Director</i>
-----------------------------------	---	---	--	------------------------------------	-----------------------------------	-------------------------------------

---

June 8, 2021

City of Miami Springs  
201 Westward Drive  
Miami Springs, FL 33166

RE: Great Miami Caterers, Inc.

Little Havana Activities & Nutrition Centers of Dade County, Inc. ("LHANC") has had the pleasure of working with Great Miami Caterers, Inc. ("GMC") for many years. As our primary meals subcontractor, they have provided our company with an extensive array of meals for all of the services we provide. They serve our child day care, our home-based clients, and the bulk meals offered at the senior centers.

The services that they provide us are competitively bid. As a result of their professionalism, fair pricing, and understanding of the intricacies of the various lines of business that we have, GMC has won the bid process on several occasions. GMC is an integral part of our network and has been instrumental during the COVID-19 pandemic in ensuring that our seniors continued to receive much needed meals without fail.

LHANC is a non-profit organization serving thousands of children and the frail elderly of Miami-Dade County for almost 50 years. LHANC prides itself in providing quality services to its clients through its employees and network of providers.

GMC is an invaluable asset for our company, and I highly recommend that you continue to use them as your preferred meals caterer.

Sincerely,

Betty Ruano-Bond  
Director, Operations and Center-based Services

E-mail: [Betty.Ruano@lhanc.org](mailto:Betty.Ruano@lhanc.org)

Contracted Since: 2014

Current Value: \$3,596,135

---

Our Partners



United Way  
Member Agency



700 S.W. 8<sup>TH</sup> Street, Miami, Florida 33130-3600  
305-858-0887 - Fax: 305-858-2225  
www.Lhanc.org

69

North Miami Foundation  
For Senior Citizens' Services, Inc.

June 6, 2021

To Whom It May Concern:

Since the late 1970's, the North Miami Foundation has contracted with Greater Miami Caterers (GMC) to prepare and deliver home delivered meals to our frail elderly clients.

With our years of experience, I can confidently say that that GMC can be relied upon to provide clients with a nutritious and satisfying meal that is delivered at both the appropriate time and temperature.

I, am therefore, pleased to write this letter of support on their behalf.

Sincerely,

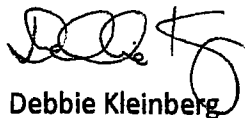

Debbie Kleinberg

Executive Director

E-mail: [dk@nmf620.org](mailto:dk@nmf620.org)  
Contracted Since: 1979  
Current Value: \$423,722



EVELYN PAZ  
Community Center Director

June 8, 2021

To Whom it May Concern,

I am writing to recommend the services of Greater Miami Caterers. We have been using their services for over twenty years. We have purchase meals for the Congregate and Home-Delivered Nutrition Program for the Elderly at our Community Center.

Greater Miami Caterers is a food service management company and has the technical knowledge required to supply such meals. They have been very reasonably priced, and always do exactly what we ask of them.

I am happy to recommend the services of Greater Miami Caterers. If you have any questions, feel free to contact me.

Sincerely,

  
Evelyn Paz

E-mail: [EvelynPaz@cityofwestmiami.org](mailto:EvelynPaz@cityofwestmiami.org)  
Contracted Since: 1997  
Current Value: \$293,616

**CITY OF WEST MIAMI**

901 S.W. 62nd Avenue • West Miami, FL 33144 • Phone: (305) 263-8900 • Fax: (305) 266-6163

E-mail: [evelynpaz@cityofwestmiami.org](mailto:evelynpaz@cityofwestmiami.org)

71

E-4

Tab E-4

72

## Resume:

Jacqueline (Jackie) Butler  
1461 NE 102 St.  
Miami Shores, FL 33138  
[jbutler@mhcater.com](mailto:jbutler@mhcater.com)  
786-797-5527

### Work Experience:

1972-1977 Had summer and part time jobs at:

**Montpelier Printing Shop** ---worked as a receptionist, making cold sales calls and collating print jobs

**El Tio Sandwiches**--- packed complete lunch meals in a tray and wrapped for lunch truck business

**Greater Miami Caterers**--- worked in the kitchen wrapping foods for at home dinner service, another summer became the receptionist taking orders and providing customer service to at home dinner service, manually counted meals to be cooked and delivered the next day to provide the kitchen a correct count

1977-1988 Worked at **Greater Miami Caterers** whenever necessary, mostly in customer service and training new hires in office, also worked in kitchen when short staffed

1988 My husband and I purchased a competitor in the dinner service business, **Master Host**, moved to Their larger building which remains as GMC's current address 4001 NW 31 Ave.

1990 to present

I became president of **Greater Miami Caterers** upon my husband David's death in 1990. I have worn many hats in the past 31 years but my main duties today are to serve as CFO of the company, hire office personnel and any management level positions including making sure all office staff serve GMC customers to the best of their ability. I, along with my assistant, Luis Porras are the GMC liaisons to present menu options when the menu cycles change twice a year. Lastly, it is my hope that my son, John Butler which is the next generation of GMC be the product of the hard work put in by his parents and his uncle, John Olmo, who laid the foundation for him not to merely follow but make better for all GMC customers and employees.

### Education:

1975 Graduated from Miami Springs Senior High  
1976-1978 Associates in Arts Degree from Miami Dade Junior College  
1979-1982 Went to FIU School of Business – Received a Bachelor of Science Degree in Finance

### Skills:

Leader  
Negotiator  
Conscientious

### Organizations:

Board member and volunteer of the Woman's Cancer Association of the University of Miami 1999-present  
Member of W.P.O.- Woman's President Organization 2014 - present

73



## Resume:

John Olmo

318 SW 163 Ave., Pembroke Pines, Fl. 33027

[jolmo@gmccater.com](mailto:jolmo@gmccater.com)

786-797-5529

### Work Experience –

Vice-President

Greater Miami Caterers, Inc.

March 1977 to present

### Education –

Batchelor's of Business Administration

University of Miami

1982

High School Diploma

Miami Springs Senior High

1977

### Skills –

Kitchen Management

Institutional Food Preparation

Menu Planning

Recipe Formulation

NSLP Certified

Facilities Management

Shipping Coordination

Office Administration

Human Resources

Accounts Payables

Accounts Receivables

Payroll

Accounting

Quickbooks & MS Office

Proprietary Pick & ES

**John R Butler**

**jrbutler500@gmail.com**

**(786) 797-5528**

**Work Experience:**

**Greater Miami Caterers**

**General Manager**

**March 2004 – Present (18 years)**

**Job Description: Over my 18 years of service, I have held about every job here at the company from packaging of meals, cooking, reheating, overnight shift manager to name a few all while assisting all other areas of the operation on a daily basis allowing me to learn all aspects of the business. I now oversee the day-to-day operations here at the company.**

**Education:**

**Archbishop Curley Notre Dame High School (1998 – 2002)**

**Felician College (2002 – 2004)**

**Johnson & Wales University (2004)**

**Skills:**

**Certified Food Service Manager**

**HAACP Certified – Seafood**

75

## Resume:

Abraham Ramos  
3522 West 71 Terr., Hialeah Gardens, Fl. 33018  
[aramos@gmcater.com](mailto:aramos@gmcater.com)  
786-608-6458

### Work Experience –

Shipping Supervisor  
Greater Miami Caterers, Inc.  
2015 to present  
Manages all day to day shipping activities

### Education –

High School Diploma  
Miami Springs Senior High  
2015

### Skills –

Shipping Coordination  
Human Resources  
Driver Payroll  
MS Office  
Proprietary Pick & ES

## Resume:

Jose Lopez

814 NW 36 Ave., Apt. 203, Miami, Fl. 33125

jose11\_lopez@yahoo.com

786-302-1925

### Work Experience –

Executive Chef

Greater Miami Caterers, Inc.

1989 to present

Coordinates all kitchen food preparation activities

Maintenance Assistant

Miami International Airport

1988 to 1989

General maintenance services to the facilities

### Education –

High School Diploma

Instituto Nacional de Oriente, Nicaragua

1982

### Skills –

Kitchen Management

Institutional Food Preparation

Menu Planning

Recipe Formulation

Stephanie Visi  
16025 NW 41st AVE  
Miami Gardens, FL 33054  
svisi@gmccater.com  
(786) 553-0521

### Work Experience

#### Greater Miami Caterers, Inc. -

Elderly Service Coordinator (2019 – present) – Working with agencies to provide a home delivered meal service to elderly and disabled clients and maintaining the service or making necessary changes as needed. Invoicing and working with QuickBooks.

Receptionist and Customer Service Representative (2015 – 2017) Creating, filing, proofreading, editing, and translating documents, organizing delivery receipts, billing, and responding to customer service phone calls (2015 – 2017)

#### QKids –

Online English tutor (2017 – 2019) – tutoring English as a foreign language to children ages 3 and up in an online classroom setting

#### National Honor Society –

Tutor in Miami Lakes Educational Center (2008) – tutoring chemistry in a classroom setting

### Education

Bachelor's Degree in Asian Studies w/ a Minor in Globalization in Latin America  
Florida International University (2014)

High School Diploma  
Miami Lakes Educational Center (2010)

### Skills

Technical: QuickBooks, SQL, and Microsoft Suite including Word, PowerPoint, Excel, Publisher, and Outlook.

Language: Fluent in English and Spanish.

**Luis P. Porras**  
1442 N.W. 27<sup>th</sup> Street  
Miami, FL 33142  
H (305) 637-3936 - C (786) 271-1710  
E-mail: [Lporras1@comcast.net](mailto:Lporras1@comcast.net)

**EMPLOYMENT Greater Miami Caterers, Inc. - Miami, Florida**

***11/2007 – Present Executive Business Administrator***

- Responsible for a variety of administrative duties including preparation of general standard catering contract for child care food program (CCFP), Adult Day Care food program (ACFP), National School Lunch Program (NSLP), Summer Food Service Program (SFSP) and private vendors. Follow up renewals, perform formal proposals, quotes and marketing presentations.
- Primary contact with permission and expertise to make decisions for the organization.
- Assist/coordinate in the preparation of hiring drivers and prepare routes during the summer.
- Responsible for maintaining on file and up-to-date manuals, certificates and permits. (State of Florida License, Occupational License, Certificate of Insurance, Liability and Workers Compensation, Alarm System Follow up, Child Care Food Program Annual Registration and Contract Updates, Boiler Room Certificate, Food Safety Certification, Health Inspections, Miami-Dade County Fire Department Permit and others.
- Coordinate and maintain staff/employees level II background check up to date files.
- Work closely with Accounts Receivable for billing purposes.
- Responsible for the supplies inventory control for the daily operations of the office.

**EDUCATION MIAMI DADE COLLEGE - Miami, Florida**

Major: Business Administration.  
Degree: (A.A.) Associate in Arts. - 04/30/2005

**TECHNICAL CAREER INSTITUTE - New York, New York**

Major: Electronic Engineering Technology.  
Degree: (A.A.S.) Associate in Applied Science. - 06/1996

**BARUCH COLLEGE (The College of Business Administration) - New York, NY**

Completed 76 Credits, with 64 credits in Humanities and Business Administration.  
Major: Computer Science & Business Administration  
Minor: Mathematics \*(G.P.A 3.85/4.0) - Graduated     No    

**CERTIFICATIONS**

- Notary Public – State of Florida # DD 579046 – Commission Expires July 30, 2022
- CEI – Certified Environmental Inspector – State of Florida No. 77282
- ServSafe Certification – Food Protection Manager Certification – Expires 02/21/2026

**Achievements/  
Capabilities**

- Certified Student of Interpretations of ISO 9000 Standards.
- **Proficient with Microsoft Office & Business Applications- Current Version 2016**
- **(Word, Excel, Power Point, Schedule, and Access) – Typing 35–45 WPM**
- Quicken (Financial Solutions) - **QuickBooks Pro**
- AHCA Portal – Background Screening Clearinghouse for Department of Elder Affairs & Florida Medicaid
- CIRTS Client Information & Registration Tracking System
- Wind2 Financial Management System (Technical Support)
- Novell NetWare-5 & Win 2000 Server (Management and Client Technical Support)
- Fast learner and able to communicate and work effectively with others.

## Resume:

Jose Ramirez

11111 SW 38 Street, Miami, Fl. 33165

[jramirez@gmcater.com](mailto:jramirez@gmcater.com)

305-767-5001

### Work Experience –

Lead Data Clerk

Greater Miami Caterers, Inc.

2015 to present

Driver & Dispatcher

American Ambulance

2012 to 2015

### Education –

Associates Degree in Physical Therapy

Miami Dade College

2015

High School Diploma

Barbara Goleman Senior High

2003

### Skills –

Proficient Data Entry

Extensive Computer Reporting Development

Menu Planning & Documentation

MS Office

Proprietary Pick

80

## Resume:

Wilson Elivo

1225 Marselles Drive, Apt. 15, Miami Beach, Fl. 33141

[elivoismael@gmail.com](mailto:elivoismael@gmail.com)

786-626-9101

### Work Experience –

Assistant Chef

Greater Miami Caterers, Inc.

2018 to present

Assists with all kitchen food preparation activities

Food Service Worker

Kikuel

2016 to 2018

General food service preparation and packaging

### Education –

Degree in Business Administration

Universida de Metropolitana, Puerto Rico

2016

Degree in Nursing

Instituto de Banca e Comercio, Puerto Rico

2012

### Skills –

Institutional Food Preparation

Recipe Formulation



# Services Implementation Strategy

Tab F

# Financial Capabilities

Tab F-1



# Master Host • Greater Miami Caterers, Inc.

LANDMARKS IN THE FOOD SERVICE INDUSTRY

4001 N.W. 31st AVE., MIAMI, FLORIDA 33142 • P.O. BOX 520752, MIAMI, FLORIDA 33152  
(305) 633-8066 • (305) 633-4616 • Broward (954) 927-3266 • Fax (305) 635-5202



## FINANCIAL CAPABILITES

With a track record of over 50 years of service to the South Florida community, Greater Miami Caterers, Inc. is one of the most well known institutional caterers in the market place. Along with those many years of experience, we have developed many long standing financial and vendor relationships which together have forged a successful partnership through good times and bad.

With these partnerships in hand, we have sustained multiple blows over the years that would have crippled most other businesses into bankruptcy, such as when JESCA closed its doors and left us with an unpaid \$160,000 balance. We have overcome all hurdles and competitive challenges in the marketplace and remain the “go to” company when others have failed to meet their service obligations. There is no better display of this than in our child care services division where severe price cutting by competition that is offering substandard service continues to pull market share. But as the sponsors see that the quality of services is not the same, they make every effort to terminate with their cut-rate provider so they can return to Greater Miami Caterers and the level of service they are accustomed to.

Another facet of our established place in the community is our ability to supply bid and performance bonding at any level needed to acquire contracts which demand the highest ability of responsiveness. We have been supplying contracts with bonds since 1984 when we were the winning bidder to the then “Community Action Agency Headstart Program” with a performance bond value of \$1,000,000.

After 38+ years of a banking relationship with Wells Fargo, we moved to Bank United about three years ago due to Wells’ decision to no longer fund our market segment. We established and secured our current line of credit of \$2,000,000 and continue to meet all underwriting guidelines. At present, we have zero funds outstanding on our line. Our last fiscal year of 2020 during covid was actually financially successful as we were able to increase our stockholder equity by 111% and end the year with a six-figure cash balance due to all the additional contracts we were able to serve in response to the pandemic.

From a food preparation standpoint, quality assurance is maintained through supervision, monitoring and documentation using various reports that are integral to the food preparation process. By following HACCP standards created for highly susceptible foods critical control points, we: 1) chart internal hot food temperatures for thorough cooking 2) chart internal food temperatures for proper cooling of hot foods within 4 hours, 3) receiving and storage check points, 4) maintain electronic cooler temperature logger for proper temperature maintenance, 5) charting of reheating temps to 165°F, 6) labeling of packaged foods including allergens and finally the 7) checkpoint at point of service when the delivery is made and the center staff review, temp and verify quality upon receipt. Any corrective action needed after that has been previously addressed.

To further support quality assurance in our services to you, in-service training to our staff has regularly been conducted and all training materials and logs of attendance have been regularly provided upon request to respond to monitoring request by your lead agency.

**Food Transportation Systems Meal Service & Delivery  
Description**

Tab F-2



# Master Host • Greater Miami Caterers, Inc.

LANDMARKS IN THE FOOD SERVICE INDUSTRY

4001 N.W. 31st AVE., MIAMI, FLORIDA 33142 • P.O. BOX 520752, MIAMI, FLORIDA 33152  
(305) 633-8066 • (305) 633-4616 • Broward (954) 927-3266 • Fax (305) 635-5202



## FOOD TRANSPORTATION SYSTEMS MEAL SERVICE & DELIVERY DESCRIPTION

Your homebound meals are regularly delivered within our morning to midday routing structure. The driver which performs these deliveries has a long standing record of many years of service for G.M.C.. We are sure that no other caterer in town can say that they have had the same drivers performing routes of this size for periods extending over twenty years.

His conscientious approach has been a tremendous asset to the execution of your delivered meals program because of the rigorous demands expected by C.M.S. of the driver. There have been instances in the past where the driver has saved lives because he has found the client unconscious or incapacitated on the floor and has notified the authorities. Clients could literally go unnoticed and unattended for days before help arrived if it weren't for our driver's regular contact. We have great pride in the job that our driver has done and due to the good salary and benefits provided him, he is happy to provide the excellent service expected of him by C.M.S..

The little details that we attend to on a daily basis assists us in providing a high standard of service. Individual meals are packaged in cambro transportation boxes that hold a maximum of fifty-five meals each and are rated to have only a 10 degree F temperature loss over 4 hours. Bulk-congregate meals also utilize the state of the art cambro food shipping containers.

All cold foods requiring a delivery temperature of 41 degrees or below are packaged on ice or dry ice in igloo, gott, rubbermaid or styro coolers. Room temperature foods are normally boxed. All foods are individually sealed to prevent any form of contamination during transit.

Congregate and homebound meals are given to the drivers at a temperature of 160 to 180 degrees Fahrenheit. The congregate meal driver leaves at 10:10 a.m. to arrive at the site at 10:30 a.m. Homebound meals depart at 11:10 a.m. and begin to arrive at their first stop at 11:30 am. The routes are executed in a cargo van and performed in a prudent and efficient manner and completed before the 1:30 pm requirement.

Frozen meal boxes to homes are delivered by placing 10 meal boxes per Super insulated storage boxes along with 8 lbs. dry ice to maintain frozen condition during shipping. These super boxes are loaded on cargo trucks that will perform all scheduled deliveries for that day.

There are innumerable staff and vehicles available to assist in problem solving. None of the ten individuals available to respond to problems have responsibilities directly related to the preparation or delivery of C.M.S. meals. The primary candidates for driver assistance are Jorge Gutierrez and Abraham Ramos with their combined twenty years of experience. Both have been called upon often in the past to help C.M.S. drivers and therefore would continue to do so through their excellent working knowledge of the food service industry and all its nuances.

## **FOOD MANAGEMENT STAFF:**

G.M.C. will interact at all levels of the company from president to cooks, on a daily basis with C.M.S..

The primary contact Program Manager on a full-time basis is John Olmo. His summary of experience is included in the G.M.C. biography. He is responsible for all aspects of service from the preparation and packaging through the delivery and billing process.

These activities are accomplished with daily interaction by: 1) Stephanie Visi, Coordinator for Homebound Elderly Services, who accepts and processes the daily changes; on the 31st of the month, they reconcile the bill for the month end for homebound services, 2) John R. Butler, kitchen manager, who monitors food packaging and preparation through his purchasing of raw materials, 3) Abraham Ramos, shipping supervisor, who on a daily basis, sees that both the drivers depart with all food products designated for that day and that all foods are at their proper temperatures (ex. Ice on cold foods), 4) John Olmo, Vice-President, who inspects daily the packaging and heating of meals for proper temperature and menu conformity, 5) Jose Lopez, executive chef, monitors menu conformity, packaging and temperature control and 6) Kenneth St. Louis, head chef, performs the major portion of the preparation of C.M.S. meals with the help of five assistants.

## **REFERENCES:**

G.M.C. has an excellent reputation in South Florida for providing good quality, timely service, at reasonable prices. Our clientele span over many market segments which have varying needs of service. We invariably prepare multiple menu plans on a routine basis. We serve breakfast, am snacks, lunch, pm snacks and dinner. A list of references are attached.

# Comprehensive Emergency Management and Contingency Plans

Tab F-3

89





# Master Host • Greater Miami Caterers, Inc.

LANDMARKS IN THE FOOD SERVICE INDUSTRY

4001 N.W. 31st AVE., MIAMI, FLORIDA 33142 • P.O. BOX 520752, MIAMI, FLORIDA 33152  
(305) 633-8066 • (305) 633-4616 • Broward (954) 927-3266 • Fax (305) 635-5202



## COMPREHENSIVE EMERGENCY MANAGEMENT AND CONTINGENCY PLANS FOR CITY OF MIAMI SPRINGS

Disabled vehicles – GMC has up to four trucks idle at all times which can rescue disabled vehicles in the rare event that multiple vehicles breakdown at the same time. In addition, we possess three large SUV's with large cargo areas which supplement back-up vehicle inventory. In summary, these redundancies in vehicles provide us with quick response fixes to vehicle breakdowns.

There is innumerable staff available to assist in problem solving. None of the ten individuals available to respond to problems have responsibilities directly related to the preparation or delivery of meals. The primary candidates for driver assistance are Abraham Ramos and Jorge Gutierrez with their combined twenty years of experience. All have been called upon often in the past to help the C.M.S. driver and therefore would continue to do so through their excellent working knowledge of the food service industry and all its nuances.

Staff shortage – GMC has not arrived to where it is today without having to respond to this problem nearly on a daily basis. All managers and assistant managers are capable of performing any and all line positions throughout our operation. If a driver calls in sick, the route is most often broken up into 2 or 3 parts so that it is accomplished within normal time standards. If any cook or food handler is out sick, staff redundancies with managerial supervision easily absorb the workload of their missing coworker. In addition, the major portion of our staff lives very near to our facility. Therefore during hurricane emergencies they are often called back in to meet the obligations GMC has to critical service providers that depend on our services to feed their work crews while they are restoring services to the residents of Miami-Dade County.

Malfunctions of kitchen equipment - in consideration of our constant refurbishment, replacement, updating, upgrading, regular maintenance and capacity expansion of all kitchen equipment and facility, our ability to respond to inevitable breakdowns is well beyond average. Operating at about 50% of capacity, our equipment does not get overworked or abused. Every major piece of equipment has, in most cases, four to six sister modules which can absorb the reduction of capacity until that failed component is brought back into service. In addition to this, GMC has a self-contained power generator which can power the entire facility in the event of a power interruption from FPL.

Non-compliance of supplier – GMC presently utilizes approximately 55 suppliers of which 25 are used on a weekly basis. We at present utilize the proverbial philosophy “don't put all your eggs in one basket”. We may from week to week or other alternating period purchase the same supplies from different suppliers. We are beholden to none and our suppliers know that they must work very hard to get and keep our business and that they must continually deliver top quality product to maintain the relationship. In summary, the only way in which GMC could be prevented from meeting menu specifications is to be exposed to a nationwide or regional shortage of a menu component which is now occurring during post-covid times.

## Quality Assurance Measures

Tab F-4



# Master Host • Greater Miami Caterers, Inc.

LANDMARKS IN THE FOOD SERVICE INDUSTRY

4001 N.W. 31st AVE., MIAMI, FLORIDA 33142 • P.O. BOX 520752, MIAMI, FLORIDA 33152  
(305) 633-8066 • (305) 633-4616 • Broward (954) 927-3266 • Fax (305) 635-5202



## QUALITY ASSURANCE MEASURES

Simply stated, our ability to cook, package and deliver a top program of your needs and magnitude has fortunately for Greater Miami Caterers (herein referred to as "G.M.C."), been displayed by us through our 50+ years of existence.

We have taken the experiences and the lessons learned in performing similar contracts, going back to our corporate infancy of the late 70's and early 80's, and have applied these high standards of service to all of our present services. These include catered meals to the City of Miami Springs, City of West Miami, South West Social Services, Hialeah Housing Authority, North Miami Foundation and to Miami-Dade County Elderly Meals Program.

Our kitchen is located at 4001 N.W. 31 Avenue, Miami, Florida 33142. Our sole office is located right next door at 3055 N.W 40 Street, Miami, Florida 33142. With a mature stature as a leader in the food service industry, we are providing an average of 20,000 meals per day to adult day care centers, meals-on-wheels to the elderly, congregate meals to the elderly, meals to charter schools and child day care with meal types comprising of hot and cold breakfast, hot lunches & dinner, cold lunches & dinner, boxed lunches & dinner, morning and afternoon snacks, shelf stable meals, frozen meals, special diet meals and a full compliment of grocery supply items for other special dietary needs including baby and toddler foods.

Our facility is one of the largest institutional kitchens operating in South Florida possessing ten (10) refrigeration units, vast production and dry goods storage areas, large vertical rotary (7) & fixed shelf (4) natural gas ovens, boiler & steam generation, 9 full jacket steam kettles ranging in size from 40 to 120 gal, candy stove and 2 double sized fryers, shipping dock overhang and an integrated operations system that is fully computerized for every facet of the business. We function on no less than twenty-five (25) different menu cycles at any one time serving an endless variety of ethnic groups.

We employ roughly 90 to 100 full-time personnel throughout the year with multiple staff with tenure in excess of ten and twenty years of employment. As well, Greater Miami Caterers is positioned for operation during a natural disaster with its own electric generator and three day replenish able fuel supply. Underground natural gas lines provide a constant supply for all ovens to continue uninterrupted service.

The capacity for G.M.C. to meet or exceed any need expressed by the C.M.S. has been displayed throughout our business existence such as full service operation unlike many of our competitors on all holidays except Christmas and New Year's days. All support systems are in place to actualize all service demands.

From a facility that is operating at 50% of its capacity with personnel that are long term and service oriented, to the financial stability that fifty+ years of business success breeds with excellent banking relationships and open lines of credit, G.M.C. is the caterer which can best continue to fill the needs of the C.M.S..

# Disaster Food Service Preparedness

Tab F-5

93



# Master Host • Greater Miami Caterers, Inc.

LANDMARKS IN THE FOOD SERVICE INDUSTRY

4001 N.W. 31st AVE., MIAMI, FLORIDA 33142 • P.O. BOX 520752, MIAMI, FLORIDA 33152  
(305) 633-8066 • (305) 633-4616 • Broward (954) 927-3266 • Fax (305) 635-5202



## Disaster Food Service Preparedness for City of Miami Springs (C.M.S.)

G.M.C. is positioned to respond to emergency food service requests by C.M.S. before, during and after the period of a natural disaster. We closely monitor weather conditions and reports by NOAA, NHC and other government agencies prior to, during and after tropical storms and hurricanes. We stay in constant communication with customers so that we can create pro-active plans based on alternative circumstances of the information available up-to-the-minute. We set up responses to situations by saying "if" this were to happen, "then" our reaction would be to do the following. We do this in case communications are disrupted so we will already know how to proceed without further communication. For example, "if" we say that if the Dade County public board issues a closure of schools, "then" your congregate meal sites will not receive meal service.

Our ability to respond to your needs will be predicated on the accessibility of your clients. As long as conditions are safe enough that a prudent person could gain access to their location, we will be happy to service all your needs. Specifically to congregate meal sites, if you have chosen to open, this choice has been made through an evaluation that certainly includes the safety of your participants. Once the decision has been made to open, we will be available to serve your centers within a 24 hour notification. These decisions though must include the consideration of accessibility to the opened location with a cargo van that can travel safely to and into the location. In regards to homebound clients, the same principles apply in terms of planning, notification, accessibility and execution of services. Particularly since you find that many homebound clients stay with other relatives during storms, the consideration of when to resume services is difficult to determine. Once resumed, we will report all clients who are not home so you can stop their services until they return home.

Prior to storm arrival, considerations to request last minute extra meals or shelf stable meals are frequently discussed. We can normally respond to boxed meals requests within 24 hours, but shelf stable meals are a request that must be considered with a minimum of 2 weeks notice prior to anticipated date of delivery. We stock limited supplies of shelf stable items, but may have enough on hand for a limited response if called upon for a last minute order.

G.M.C.'s facility has generator capacity for electrical back-up & operates on underground natural gas pipelines. Unless gas lines are cut off, we will be able to serve hot food on an ongoing basis. To date, our gas supply has never been interrupted. We believe that this supply is much more reliable than LP gas due to service interruptions caused by road conditions and the overwhelming delivery demands made on an LP gas company's after an emergency.

G.M.C. as well, has access to mobile generator electrical capacity through our electrical contractor vendor. If we were to have a disruption to our built in generator, we would have a back-up to our back-up. All of our kitchen equipment will function as normal while we are operating under generated power means. In addition, our truck fleet will continue to operate through our own tank storage and dispensing of gasoline and diesel fuels on premise. We can typically operate our entire fleet for one week under full service demand before receiving our next fuel delivery.

94

**Disaster Food Service Preparedness  
for City of Miami Springs (C.M.S.)  
Continued.....**

Our ability to staff before and after a storm has always been a great asset to our company. The majority of our employees lives within 3 to 5 miles of our facility and therefore are placed on call notice of when to return to work as soon as the decision has been made. Since many other parts of our regular business do not resume immediately after a storm, there is normally an excess capacity of staff available to fill post storm needs.

We will operate on a full service basis to the capacity at which our suppliers are able to respond to our orders for raw materials for production. We expect to be able to serve most typical food items that you would find when serving breakfast, hot lunch, box lunch, dinner and snacks. In this regard, some menu substitution may take place due to unavailability of specific foods, but these substitutions will be made with like foods that meet reimbursable standards. We regularly purchase on occasion from as many as 85 different food suppliers of which at least 30 are used on a weekly basis. Through all of these alternative sources, we will purchase all of the products needed to match your menus exactly or as close as possible.

**Approved four week menu cycle, attestation and nutrient analysis, holiday menus, field trip and picnic menus**

**Greater Miami Caterers, Inc.**  
 4001 N.W. 31st Ave., Miami, FL 33142  
 Ph. (305) 633-4616 Fx. (305) 635-5202

EFFECTIVE: JULY 19, 2021 - JANUARY 16, 2022

**CITY OF MIAMI SPRINGS HOMEBOUND  
 MENU B - C2 - CATEGORY 5 - WEEK ONE**

LUNCH PATTERN:	MONDAY:	TUESDAY:	WEDNESDAY:	THURSDAY:	FRIDAY:	SATURDAY:	SUNDAY:
MEAT OR ALTERNATIVE 3 OZ. COOKED EDIBLE PORTION	3 OZ. ROASTED CHICKEN W/ MOJO	3 OZ. MEAT LOAF W/ 1 OZ. GRAVY	3 OZ. SLICED ROAST PORK AU JUS	3 OZ. ROPA VIEJA (SHREDDED BEEF W/ PEPPER & ONION)	2 CHEESE MANICOTTI W/ TOMATO SAUCE	1/4 PIECE ROAST CHICKEN (8 OZ.) W/ MUSHROOM GRAVY	MIDNIGHT SANDWICH W/ 3 OZ. PORK, HAM, AND SWISS CHEESE
VEGETABLE, LEAFY SALAD, JUICE OR BEANS 1st SERVING - 1/2 CUP	1/2 CUP RED BEAN SOUP	1/2 CUP MASHED POTATOES	1/2 CUP ROASTED RED POTATOES	1/2 CUP SPINACH SALAD W/ 2 CHERRI TOMATOES W/ LITE DRESS.	1/2 CUP STEAMED BROCCOLI	1/2 CUP MASHED POTATOES	1 PK. POTATO CHIPS
VEGETABLE, LEAFY SALAD, JUICE OR BEANS 2nd SERVING - 1/2 CUP	1/2 CUP STEAMED SPINACH W/ GARLIC	1/2 CUP GREEN BEANS & ONIONS	1/2 CUP MIXED VEGETABLES	1/2 CUP SLICED CARROTS	1/2 CUP MARINATED TOMATO & CUCUMBER SALAD	1/2 CUP MIXED VEGETABLES W/ GARLIC BUTTER	1- 5.5 OZ. V-8 JUICE
FRUIT 1/2 CUP	1 EA. FRESH BANANA	1/2 CUP FRUITED JELLO	1/2 CUP APPLESAUCE	1/2 CUP PINEAPPLE TIDBITS IN JUICE	1 EA. FRESH ORANGE	FRESH BANANA	1/2 CUP FRUIT MIX
BREAD OR ALTERNATE, ENRICHED 1st SERVING	1/2 CUP BROWN RICE	(2) WHEAT DINNER ROLLS	(1) WW ROLL	(1) SL. WW BREAD	(1) SL. WW BREAD	(1) WHEAT DINNER ROLL	(1) SLICE WHOLE WHEAT BREAD
BREAD OR ALTERNATE, ENRICHED							(1) SLICE WHOLE WHEAT BREAD
MARGARINE, FORTIFIED 1 TSP.		MARGARINE REDDIE					1 PC. MUSTARD
MILK OR ALTERNATIVE, LOW-FAT PRODUCTS 8 OZ.	1% MILK	1% MILK	1% MILK	1% MILK	1% MILK	1% MILK	1% MILK
OPTIONAL FOODS - DESSERT OR OTHER							

*[Signature]*  
 DIETITIAN SIGN-OFF  
 ND 1885

DIETITIAN SIGN-OFF:

LICENSE #:

DATE:

LICENSE #:

DATE: 5/19/21



**Greater Miami Caterers, Inc.**  
 4001 N.W. 31st Ave., Miami, FL 33142  
 Ph. (305) 633-4616 Fx. (305) 635-5202

EFFECTIVE: JULY 19, 2021 - JANUARY 16, 2022

**CITY OF MIAMI SPRINGS HOMEBOUND  
 MENU B - C2 - CATEGORY 5 - WEEK TWO**

LUNCH PATTERN: MEAT OR ALTERNATIVE 3 OZ. COOKED EDIBLE PORTION	MONDAY: 3-1 OZ. MEATBALLS W/ TOMATO SAUCE	TUESDAY: 8 OZ. PORT. CHICKEN(3oz.) & YELLOW/BROWN RICE	WEDNESDAY: 3 OZ. BEEF CHILI CON CARNE	THURSDAY: 1/4 LEG (8 OZ.) BBQ CHICKEN	FRIDAY: 8 OZ. BAKED ZITI (2 OZ. MEAT, 1 OZ. CHEESE, 1 OZ. MARINARA)	SATURDAY: 3 OZ. SLICED TURKEY W/ GRAVY	SUNDAY: ITALIAN SUB: 1 OZ. HAM, 1 OZ. SALAMI, 1 OZ. PROVOLONE ON WW SUB ROLL.
VEGETABLE, LEAFY SALAD, JUICE OR BEANS 1st SERVING - 1/2 CUP	1/2 CUP GREEN BEANS ALMONDINE	1/2 CUP OVEN FRIED PLANTAINS	1/2 CUP KIDNEY BEANS IN CHILI	1/2 CUP STEAMED CARROTS	1/2 CUP VEGETABLE SOUP	1/2 CUP ROASTED DICED SWEET POTATO	1 PKG. SUNCHIPS
VEGETABLE, LEAFY SALAD, JUICE OR BEANS 2nd SERVING - 1/2 CUP	1/2 CUP MIXED GREEN SALAD W/ ITALIAN DRESSING	1/2 CUP LETTUCE & TOMATO SALAD WITH 1 TBSP LITE DRESSING	1/2 CUP SPINACH SALAD W/ LITE DRESSING	1/2 CUP MARINATED TOMATO, ONION & BROCCOLI SALAD	1/2 CUP CAESAR SALAD W/ 1 T. LITE CAESAR DRESSING	1/2 CUP BROCCOLI W/ CHEESE SAUCE	1/2 CUP LETTUCE W/ 2 CHERRY TOMATOES
FRUIT 1/2 CUP	1 EA. FRESH TANGERINE		PEACHES IN JUICE	1 EA. FRESH ORANGE	1/2 CUP MELON IN SEASON	FRESH PEAR	1 EA. ORANGE
BREAD OR ALTERNATE, ENRICHED 1st SERVING	1/2 CUP SPAGHETTI NOODLES W/ TOMATO SAUCE	1/2 CUP YELLOW/BROWN RICE ABOVE	1/2 CUP BROWN RICE	1/2 CUP MACARONI AND CHEESE	1/2 CUP PASTA ZITI ABOVE	(1) SLICE WHOLE WHEAT BREAD	
BREAD OR ALTERNATE, ENRICHED 2nd SERVING	(1) WHOLE WHEAT ROLL	(1) WW CUBAN CRACKER	(1) WHOLE GRAIN CORNBREAD MUFFIN	(1) WHEAT DINNER ROLL	(1) WW GARLIC ROLL		
MARGARINE, FORTIFIED 1 TSP.							1 PC. ITALIAN DRESSING
MILK OR ALTERNATIVE, LOW-FAT PRODUCTS 8 OZ.	1% MILK	1% MILK	1% MILK	1% MILK	1% MILK	1% MILK	1% MILK
OPTIONAL FOODS - DESSERT OR OTHER	1/2 CUP FRUITED GELATIN						

DIETITIAN SIGN-OFF: \_\_\_\_\_  
 LICENSE #: \_\_\_\_\_  
 DATE: \_\_\_\_\_

DIETITIAN SIGN-OFF: \_\_\_\_\_  
 LICENSE #: \_\_\_\_\_  
 DATE: \_\_\_\_\_

98

**Greater Miami Caterers, Inc.**  
 4001 N.W. 31st Ave., Miami, FL 33142  
 Ph. (305) 633-4816 Fx. (305) 635-5202

EFFECTIVE: JULY 19, 2021 - JANUARY 16, 2022

**CITY OF MIAMI SPRINGS HOMEBOUND  
 MENU B - C2 - CATEGORY 5 - WEEK THREE**

LUNCH PATTERN: MEAT OR ALTERNATIVE 3 OZ. COOKED EDIBLE PORTION	MONDAY: 1/2 CUP CHICKEN FRIGASEE W/ POTATOES, OLIVES, PEPPER & ONIONS	TUESDAY: 3 OZ. SHREDDED ROAST PORK W/ MOJO & ONIONS	WEDNESDAY: 3 OZ. CHICKEN BREAST W/ MARSALA SAUCE	THURSDAY: 3 OZ. PICADILLO	FRIDAY: 3 OZ. PORK CHOP W/ GRAVY	SATURDAY: 7 OZ. BAKED ZITI W/ 4 OZ. GROUND BEEF & MOZZARELLA CHEESE	SUNDAY: 1 EA. CUBAN SANDWICH W/ 3 OZ. PORK, HAM & SWISS CHEESE
VEGETABLE LEAFY SALAD, JUICE OR BEANS 1st SERVING - 1/2 CUP	1/2 CUP GALICIAN SOUP	1/2 CUP MOROS (BLACK BEANS & RICE)	1 CUP QUINOA PILAF W/ PEAS & DICED RED PEPPER	1/2 CUP OVEN FRIED PLANTAINS	1/2 CUP MASHED POTATOES	1/2 CUP BABY CARROTS	1 PK. PLANTAIN CHIPS
VEGETABLE, LEAFY SALAD, JUICE OR BEANS 2nd SERVING - 1/2 CUP	1/2 CUP GREEN BEANS W/ MUSHROOM, ONION & GARLIC	1/4 CUP YUCA W/ MOJO	1/2 CUP MIXED GREEN SALAD W/ 1 TBSP OIL & VINEGAR DRESS.	1/2 CUP LETTUCE, TOMATO & CARROTS SALAD W/ T. LITE DRESSING	1/2 CUP BEETS	1/2 CUP GREEN BEANS	
FRUIT 1/2 CUP	1/2 CUP MIXED FRUIT IN JUICE	1 EA. FRESH BANANA	1 SL. FRESH MELON IN SEASON	1/2 CUP PINEAPPLE TIDBITS	1/2 CUP YOGURT W/ BERRIES	1 EA. FRESH SEASONAL FRUIT (ORANGE)	1/2 CUP FORTIFIED ORANGE JUICE
BREAD OR ALTERNATE, ENRICHED 1st SERVING	1/2 CUP BROWN RICE			1/2 CUP WHITE RICE	(1) WHOLE GRAIN CORN MUFFIN		(1) SLICE WHOLE WHEAT BREAD
BREAD OR ALTERNATE, ENRICHED 2nd SERVING	(1) WHEAT DINNER ROLL		(1) WW DINNER ROLL				(1) SLICE WHOLE WHEAT BREAD
MARGARINE, FORTIFIED 1 TSP.			MARGARINE REDDIE				1 PK. MUSTARD 1 PK. MAYO
MILK OR ALTERNATIVE, LOW-FAT PRODUCTS 8 OZ.	1% MILK	1% MILK	1% MILK	1% MILK	1% MILK	1% MILK	1% MILK
OPTIONAL FOODS - DESSERT OR OTHER		1/2 CUP LETTUCE & TOMATO W/ LITE DRESSING					1/2 CUP VANILLA PUDDING

DIETITIAN SIGN-OFF: *[Signature]*  
 LICENSE #: ND1885  
 DATE: 5/19/21

DIETITIAN SIGN-OFF: \_\_\_\_\_  
 LICENSE #: \_\_\_\_\_  
 DATE: \_\_\_\_\_

**Greater Miami Caterers, Inc.**  
 4001 N.W. 31st Ave., Miami, FL 33142  
 Ph. (305) 633-4616 Fx. (305) 635-5202

EFFECTIVE: JULY 19, 2021 - JANUARY 16, 2022

**CITY OF MIAMI SPRINGS HOMEBOUND  
 MENU B - C2 - CATEGORY 5 - WEEK FOUR**

LUNCH PATTERN:	MONDAY:	TUESDAY:	WEDNESDAY:	THURSDAY:	FRIDAY:	SATURDAY:	SUNDAY:
MEAT OR ALTERNATIVE 3 OZ. COOKED EDIBLE PORTION	3 OZ. EYE ROUND ROAST IN SAUCE	(3 OZ.) ROAST TURKEY W/ 1 OZ. GRAVY	3 OZ. CHICKEN CORDON BLEU	7 OZ. MEAT LASAGNA (2 OZ. GROUND BEEF, 1 OZ. MOZZARELLA CHEESE & 1/2 C PASTA W/ TOMATO SAUCE)	3 OZ. BAKED FISH W/ PEPPERS, ONIONS & OLIVES	1/4 OVEN FRIED CHICKEN (3 oz.) LEG	2 OZ. SLICED TURKEY 1 OZ. SLICED PROVOLONE CHEESE
VEGETABLE, LEAFY SALAD, JUICE OR BEANS 1st SERVING - 1/2 CUP	1/2 CUP BLACK BEAN SOUP	3/4 CUP CUT YAMS	1/2 CUP BROWN RICE	1 CUP GARLIC & HERB ROAST CARROTS	(1) CUP LENTIL SOUP	1/2 CUP WASHED POTATOES W/ GRAVY	1 PKG. POTATO CHIPS
VEGETABLE, LEAFY SALAD, JUICE OR BEANS 2nd SERVING - 1/2 CUP	1/2 CUP ITALIAN BLEND VEGETABLES	1/2 CUP SEASONED GREEN BEANS	1/2 CUP ORIENTAL BLEND VEGETABLES	1/2 CUP COOKED SPINACH	1/2 CUP GREEN BEANS W/ ONIONS & BUTTER	1- 5.5 OZ. V-8 JUICE	
FRUIT 1/2 CUP	FRESH BANANA	1 EA. FRESH ORANGE	1 EA. FRESH PEAR	FRESH APPLE	1/2 CUP FRUITED YOGURT	FRESH BANANA	FRESH ORANGE
BREAD OR ALTERNATE, ENRICHED 1st SERVING	1/2 CUP BROWN RICE	1/2 CUP STUFFING		1/2 CUP PASTA ABOVE	1/2 CUP WHITE RICE	(1) SLICE MULTIGRAIN BREAD	
BREAD OR ALTERNATE, ENRICHED 2nd SERVING	(1) WW ROLL			(1) WW GARLIC ROLL	(1) WW ROLL		(1) WW HAMBURGER ROLL
MARGARINE, FORTIFIED 1 TSP.	MARGARINE REDDIE						MAYO PKT MUSTARD PKT
MILK OR ALTERNATIVE, LOW-FAT PRODUCTS 8 OZ.	1% MILK	1% MILK	1% MILK	1% MILK	1% MILK	1% MILK	1% MILK
OPTIONAL FOODS - DESSERT OR OTHER			1/2 CUP SPINACH & CUCUMBER SALAD W/ FRENCH DRESS.		1 EA. OATMEAL COOKIE		1/2 CUP TAPIOCA PUDDING

DIETITIAN SIGN-OFF: \_\_\_\_\_  
 LICENSE #: \_\_\_\_\_  
 DATE: \_\_\_\_\_

DIETITIAN SIGN-OFF: \_\_\_\_\_  
 LICENSE #: \_\_\_\_\_  
 DATE: \_\_\_\_\_

100

**Greater Miami Caterers, Inc.**  
 4001 N.W. 31st Ave., Miami, FL 33142  
 Ph. (305) 633-4616 Fx. (305) 635-5202

EFFECTIVE: JULY 19, 2021 - JANUARY 16, 2022

**CITY OF MIAMI SPRINGS - CONGREGATE  
 MENU B - C2 - CATEGORY 5 - WEEK ONE**

LUNCH PATTERN:	MONDAY:	TUESDAY:	WEDNESDAY:	THURSDAY:	FRIDAY:
MEAT OR ALTERNATIVE 3 OZ. COOKED EDIBLE PORTION	3 OZ. ROASTED CHICKEN W/ MOJO	3 OZ. MEAT LOAF W/ 1 OZ. GRAVY	3 OZ. SLICED ROAST PORK AU JUS	3 OZ. ROPA VIEJA (SHREDDED BEEF W/ PEPPER & ONION)	3 OZ. CHICKEN SALAD (LOW SALT)
VEGETABLE, LEAFY SALAD, JUICE OR BEANS 1st SERVING - 1/2 CUP	1/2 CUP RED BEAN SOUP	1/2 CUP MASHED POTATOES	1/2 CUP ROASTED RED POTATOES	1/2 CUP SPINACH SALAD W/ 2 CHERR TOMATOES W/ LITE DRESS.	1/2 CUP CREAM OF BROCCOLI SOUP
VEGETABLE, LEAFY SALAD, JUICE OR BEANS 2nd SERVING - 1/2 CUP	1/2 CUP STEAMED SPINACH W/ GARLIC	1/2 CUP GREEN BEANS & ONIONS	1/2 CUP SPLIT PEA SOUP	1/2 CUP SLICED CARROTS	1/2 CUP LETTUCE LEAF & SLICED TOMATO
FRUIT 1/2 CUP	1 EA. FRESH BANANA	1/2 CUP FRUITED JELLO	1/2 CUP APPLESAUCE	1/2 CUP PINEAPPLE TIDBITS IN JUICE	1 EA. FRESH ORANGE
BREAD OR ALTERNATE, ENRICHED 1st SERVING	1/2 CUP BROWN RICE			1/2 CUP BROWN RICE	(1/2 ) WHOLE WHEAT HAMBURGER BUN
BREAD OR ALTERNATE, ENRICHED 2nd SERVING		(2) WHEAT DINNER ROLLS	(1) WW ROLL		(1/2 ) WHOLE WHEAT HAMBURGER BUN
MARGARINE, FORTIFIED 1 TSP.		MARGARINE REDDIE			
MILK OR ALTERNATIVE, LOW-FAT PRODUCTS 8 OZ.	1% MILK	1% MILK	1% MILK	1% MILK	1% MILK
OPTIONAL FOODS - DESSERT OR OTHER			1/2 CUP TOSSED SALAD W/ LITE DRESSING		

DIETITIAN SIGN-OFF: *Deborah L. Foster* DIETITIAN SIGN-OFF: \_\_\_\_\_  
 LICENSE #: NP 1885 LICENSE #: \_\_\_\_\_  
 DATE: 5/19/21 DATE: \_\_\_\_\_



**Greater Miami Caterers, Inc.**  
 4001 N.W. 31st Ave., Miami, FL 33142  
 Ph. (305) 633-4616 Fx. (305) 635-5202

EFFECTIVE: JULY 19, 2021 - JANUARY 16, 2022

**CITY OF MIAMI SPRINGS - CONGREGATE  
 MENU B - C2 - CATEGORY 5 - WEEK THREE**

	MONDAY:	TUESDAY:	WEDNESDAY:	THURSDAY:	FRIDAY:
LUNCH PATTERN: MEAT OR ALTERNATIVE 3 OZ. COOKED EDIBLE PORTION	4 OZ. CHICKEN FRICASEE W/ POTATOES, OLIVES, PEPPER & ONIONS	3 OZ. SHREDDED ROAST PORK W/ MOJO & ONIONS	3 OZ. CHICKEN BREAST W/ MARSALA SAUCE	3 OZ. PICADILLO	3 OZ. PORK CHOP W/ GRAVY
VEGETABLE, LEAFY SALAD, JUICE OR BEANS 1st SERVING - 1/2 CUP	1/2 CUP GALICIAN SOUP	1/2 CUP MOROS (BLACK BEANS & RICE)	1 CUP QUINOA PILAF W/ PEAS & DICED RED PEPPER	1/2 CUP OVEN FRIED PLANTAINS	1/2 CUP MASHED POTATOES
VEGETABLE, LEAFY SALAD, JUICE OR BEANS 2nd SERVING - 1/2 CUP	1/2 CUP GREEN BEANS W/ MUSHROOM, ONION & GARLIC	1/4 CUP YUCA W/ MOJO	1/2 CUP MIXED GREEN SALAD W/ 1 TBSP OIL & VINEGAR DRESS.	1/2 CUP LETTUCE, TOMATO & CARROTS SALAD W/ T. LITE DRESSING	1/2 CUP BEETS
FRUIT 1/2 CUP	1/2 CUP MIXED FRUIT IN JUICE	1 EA. FRESH BANANA	1 SL. FRESH MELON IN SEASON	1/2 CUP PINEAPPLE TIDBITS	1/2 CUP YOGURT W/ BERRIES
BREAD OR ALTERNATE, ENRICHED 1st SERVING	1/2 CUP BROWN RICE			1/2 CUP WHITE RICE	(1) WHOLE GRAIN CORN MUFFIN
BREAD OR ALTERNATE, ENRICHED 2nd SERVING	(1) WHEAT DINNER ROLL		(1) WW DINNER ROLL		
MARGARINE, FORTIFIED 1 TSP.			MARGARINE REDDIE		
MILK OR ALTERNATIVE, LOW-FAT PRODUCTS 8 OZ.	1% MILK	1% MILK	1% MILK	1% MILK	1% MILK
OPTIONAL FOODS - DESSERT OR OTHER		1/2 CUP LETTUCE & TOMATO W/ LITE DRESSING			

DIETITIAN SIGN-OFF: *Josephine L. ...*  
 ND 1885

DIETITIAN SIGN-OFF: \_\_\_\_\_  
 LICENSE #: \_\_\_\_\_

DATE: 5/19/21

DATE: \_\_\_\_\_

DATE: \_\_\_\_\_

**Greater Miami Caterers, Inc.**  
 4001 N.W. 31st Ave., Miami, FL 33142  
 Ph. (305) 633-4616 Fx. (305) 635-5202

EFFECTIVE: JULY 19, 2021 - JANUARY 16, 2022

**CITY OF MIAMI SPRINGS - CONGREGATE  
 MENU B - C2 - CATEGORY 5 - WEEK FOUR**

	MONDAY:	TUESDAY:	WEDNESDAY:	THURSDAY:	FRIDAY:
LUNCH PATTERN: MEAT OR ALTERNATIVE 3 OZ. COOKED EDIBLE PORTION	3 OZ. EYE ROUND ROAST IN SAUCE	(3 OZ.) ROAST TURKEY W/ 1 OZ. GRAVY	3 OZ. CHICKEN CORDON BLEU	7 OZ. MEAT LASAGNA (2 OZ. GROUND BEEF, 1 OZ. MOZZARELLA CHEESE & 1/2 C. PASTA W/TOMATO SAUCE)	4 OZ. TUNA SALAD
VEGETABLE, LEAFY SALAD, JUICE OR BEANS 1st SERVING - 1/2 CUP	1/2 CUP BLACK BEAN SOUP	3/4 CUP CUT YAMS	1/2 CUP BROWN RICE	1/2 CUP GARLIC & HERB ROAST CARROTS	(1) CUP LENTIL SOUP
VEGETABLE, LEAFY SALAD, JUICE OR BEANS 2nd SERVING - 1/2 CUP	1/2 CUP ITALIAN BLEND VEGETABLES	1/2 CUP SEASONED GREEN BEANS	1/2 CUP ORIENTAL BLEND VEGETABLES	1/2 CUP CAESAR SALAD	1/2 CUP ROMAINE LETTUCE LEAF AND SLICED TOMATO
FRUIT 1/2 CUP	FRESH BANANA	1 EA. FRESH ORANGE	1 EA. FRESH PEAR	FRESH APPLE	1/2 CUP AMBROSIA FRUIT SALAD MANDARIN ORANGE & YOGURT
BREAD OR ALTERNATE, ENRICHED 1st SERVING	1/2 CUP BROWN RICE	1/2 CUP STUFFING		1/2 CUP PASTA ABOVE	1/2 WHEAT HAMBURGER BUN
BREAD OR ALTERNATE, ENRICHED 2nd SERVING	(1) WW ROLL			(1) WW GARLIC ROLL	1/2 WHEAT HAMBURGER BUN
MARGARINE, FORTIFIED 1 TSP.	MARGARINE REDDIE				
MILK OR ALTERNATIVE, LOW-FAT PRODUCTS 8 OZ.	1% MILK	1% MILK	1% MILK	1% MILK	1% MILK
OPTIONAL FOODS - DESSERT OR OTHER			1/2 CUP SPINACH & CUCUMBER SALAD W/ FRENCH DRESS.		OATMEAL COOKIE

DIETITIAN SIGN-OFF: *Janet P. ...* DIETITIAN SIGN-OFF: \_\_\_\_\_  
 LICENSE #: ND 1885 LICENSE #: \_\_\_\_\_  
 DATE: 5/19/21 DATE: \_\_\_\_\_

Greater Miami Caterers, Inc.

EFFECTIVE: JULY 19, 2021 - JANUARY 16, 2022

CITY OF MIAMI SPRINGS BREAKFAST MENU

( Remember that meals are delivered the day before they appear on the menu )

WEEK 1 - Effective: July 26, 2021

	MONDAY:	TUESDAY:	WEDNESDAY:	THURSDAY:	FRIDAY:	SATURDAY:	SUNDAY:
8 OZ. MILK	1 % MILK	1 % MILK	1 % MILK	1 % MILK	1 % MILK	1 % MILK	1 % MILK
BREAD OR CEREAL EQUIVALENT 1 SERVING	(1) - 1 OZ. RAISIN BRAN CEREAL BOWL PACK	(1) - 0.69 OZ. TOTAL CEREAL BOWL PACK	(1) - 3/4 CUP TOTAL CEREAL BOWL PACK	(1) - 0.69 OZ. 40% BRAN FLAKES CEREAL BOWL PACK	(1) - 1.25 OZ. SPECIAL-K CEREAL BOWL PACK	(1) - 1 OZ. RAISIN BRAN CEREAL BOWL PACK	(1) - 3.6 OZ. CRANBERRY BREAD MUFFIN
OPTIONAL 2nd SERVING BREAD OR CEREAL EQUIVALENT	(1) SLICE WHOLE WHEAT ENGLISH MUFFIN	(1) SLICE WHOLE WHEAT BREAD	(1) - 3.6 OZ. BRAN MUFFIN	(2) SLICES WHOLE WHEAT BREAD	(2) SLICES WHOLE WHEAT BREAD	(2) SLICES WHOLE WHEAT BREAD	
FRUIT OR JUICE 1/2 CUP	(1) FRESH ORANGE	(1) FRESH APPLE (1) - 4 OZ. ** ORANGE JUICE	(1) FRESH BANANA (1) - 4 OZ. ** ORANGE JUICE	(1) - 8 OZ. ** ORANGE JUICE	(1) FRESH ORANGE (1) - 4 OZ. APPLE JUICE	(1) - 8 OZ. ** ORANGE JUICE	(1) FRESH ORANGE
MARGARINE 1 SERVING	(1) MARGARINE REDDIE PC	(1) MARGARINE REDDIE PC	(1) MARGARINE REDDIE PC.	(1) MARGARINE REDDIE PC	(1) MARGARINE REDDIE PC	(1) MARGARINE REDDIE PC	
OTHER FOODS	(2) - 4 OZ. * LITE FRUITED YOGURT	(1) - 4 OZ. YOGURT	(1) - 1/2 CUP or 4 OZ. COTTAGE CHEESE	(1) - 8 OZ. LITE YOGURT	(2) - 4 OZ. * FRUITED YOGURT	(1) - 4 OZ. LITE YOGURT	(1) - 8 OZ. YOGURT
ADDITIONAL FOOD ITEMS							

\* Fruited Yogurt flavors are: Strawberry, Blueberry, Peach and Strawberry/Banana  
 \*\* Orange Juice Is - Calcium Fortified

DIETITIAN SIGN-OFF: Mary M. Stenberg MS RD, LDN, CNSC  
 W/ NUTRITIONAL ANALYSIS  
 LICENSE #: NP 7257

DATE: 6/2/21



Greater Miami Caterers, Inc.

EFFECTIVE: JULY 19, 2021 - JANUARY 16, 2022

CITY OF MIAMI SPRINGS BREAKFAST MENU

(Remember that meals are delivered the day before they appear on the menu)

WEEK 2 - Effective: August 2, 2021

	MONDAY:	TUESDAY:	WEDNESDAY:	THURSDAY:	FRIDAY:	SATURDAY:	SUNDAY:
8 OZ. MILK	1 % MILK	1 % MILK	1 % MILK	1 % MILK	1 % MILK	1 % MILK	1 % MILK
BREAD OR CEREAL EQUIVALENT 1 SERVING	(1) - 0.69 OZ. RAISIN BRAN CEREAL BOWL PACK	(1) - 1.25 OZ. SPECIAL-K CEREAL BOWL PACK	(1) WHOLE WHEAT ENGLISH MUFFIN	(1) - 1.25 OZ. ALL BRAN CEREAL BOWL PACK	(1) - 3/4 CUP TOTAL CEREAL BOWL PACK	(1) - 0.69 OZ. 40 % BRAN FLAKES CEREAL BOWL PACK	
OPTIONAL 2nd SERVING BREAD OR CEREAL EQUIVALENT	(1) WHOLE WHEAT ENGLISH MUFFIN	(2) SLICES WHOLE WHEAT BREAD	(1) LOW FAT CEREAL BAR	(1) WHOLE WHEAT ENGLISH MUFFIN	(1) - 3.6 OZ. BANANA BREAD MUFFIN	(2) SLICES WHOLE WHEAT BREAD	(1) - 3.6 OZ. BRAN BREAD MUFFIN
FRUIT OR JUICE 1/2 CUP	(1) CUP CANTALOUPE	(1) FRESH ORANGE (1) - 4 OZ. APPLE JUICE	(1) FRESH ORANGE	(1) FRESH ORANGE	(1) FRESH BANANA (1) - 4 OZ. ** ORANGE JUICE	(1) FRESH BANANA	(1) FRESH ORANGE
MARGARINE 1 SERVING	(1) PC JELLY	(1) MARGARINE REDDIE PC.	(1) MARGARINE REDDIE PC	(1) MARGARINE REDDIE PC.	(1) MARGARINE REDDIE PC.	(2) MARGARINE REDDIE PC.	
OTHER FOODS	(1) - 4 OZ. * FRUITED YOGURT		(2) - 4 OZ. * FRUITED YOGURT	(1) HARD BOILED EGG	(1) - 3/4 CUP or 6 OZ. COTTAGE CHEESE	(2) - 4 OZ. * FRUITED YOGURT	(1) - 8 OZ. COTTAGE CHEESE
ADDITIONAL FOOD ITEMS	(1) HARD BOILED EGG	(2) - 4 OZ. * FRUITED YOGURT		(2) - 4 OZ. * FRUITED YOGURT			

\* Fruited Yogurt flavors are: Strawberry, Blueberry, Peach and Strawberry/Banana  
 \*\* Orange Juice is - Calcium Fortified

DIETITIAN SIGN-OFF: Maria Melendez MS RD, LD, CNSC  
 W/ NUTRITIONAL ANALYSIS NP 7257  
 LICENSE #:

AGENCY  
 DIETITIAN SIGN-OFF:  
 LICENSE #:

DATE: 08/21

DATE:

Greater Miami Caterers, Inc.

EFFECTIVE: JULY 19, 2021 - JANUARY 16, 2022

CITY OF MIAMI SPRINGS BREAKFAST MENU

( Remember that meals are delivered the day before they appear on the menu )

WEEK 3 - Effective: August 9, 2021

	MONDAY:	TUESDAY:	WEDNESDAY:	THURSDAY:	FRIDAY:	SATURDAY:	SUNDAY:
8 OZ. MILK	1 % MILK	1 % MILK	1 % MILK	1 % MILK	1 % MILK	1 % MILK	1 % MILK
BREAD OR CEREAL EQUIVALENT 1 SERVING	(1) - 1 OZ. RAISIN BRAN CEREAL BOWL PACK	(1) - 0.69 OZ. TOTAL CEREAL BOWL PACK	(1) - 3/4 CUP TOTAL CEREAL BOWL PACK	(1) - 0.69 OZ. 40% BRAN FLAKES CEREAL BOWL PACK	(1) - 1.25 OZ. SPECIAL-K CEREAL BOWL PACK	(1) - 1 OZ. RAISIN BRAN CEREAL BOWL PACK	(1) - 3.6 OZ. CRANBERRY BREAD MUFFIN
OPTIONAL 2nd SERVING BREAD OR CEREAL EQUIVALENT	(1) WHOLE WHEAT ENGLISH MUFFIN	(1) SLICE WHOLE WHEAT BREAD	(1) - 3.6 OZ. BRAN MUFFIN	(2) SLICES WHOLE WHEAT BREAD	(2) SLICES WHOLE WHEAT BREAD	(2) SLICES WHOLE WHEAT BREAD	
FRUIT OR JUICE 1/2 CUP	(1) FRESH ORANGE	(1) FRESH APPLE (1) - 4 OZ. ** ORANGE JUICE	(1) FRESH BANANA (1) - 4 OZ. ** ORANGE JUICE	(1) - 8 OZ. ** ORANGE JUICE	(1) FRESH ORANGE (1) - 4 OZ. APPLE JUICE	(1) - 8 OZ. ** ORANGE JUICE	(1) FRESH ORANGE
MARGARINE 1 SERVING	(1) MARGARINE REDDIE PC	(1) MARGARINE REDDIE PC	(1) MARGARINE REDDIE PC.	(1) MARGARINE REDDIE PC	(1) MARGARINE REDDIE PC	(1) MARGARINE REDDIE PC	
OTHER FOODS	(2) - 4 OZ. * LITE FRUITED YOGURT	(1) - 4 OZ. YOGURT	(1) - 1/2 CUP or 4 OZ. COTTAGE CHEESE	(1) - 8 OZ. LITE YOGURT	(2) - 4 OZ. * FRUITED YOGURT	(1) - 4 OZ. LITE YOGURT	(1) - 8 OZ. YOGURT
ADDITIONAL FOOD ITEMS							

\* Fruited Yogurt flavors are: Strawberry, Blueberry, Peach and Strawberry/Banana

\*\* Orange Juice is - Calcium Fortified

DIETITIAN SIGN-OFF: Maura Mulroney, MS RD, LDN, CNSC  
 W/ NUTRITIONAL ANALYSIS  
 LICENSE #: NO 7257

AGENCY: \_\_\_\_\_  
 DIETITIAN SIGN-OFF: \_\_\_\_\_  
 LICENSE #: \_\_\_\_\_  
 DATE: 6/10/21

Greater Miami Caterers, Inc.

EFFECTIVE: JULY 19, 2021 - JANUARY 16, 2022

CITY OF MIAMI SPRINGS BREAKFAST MENU

(Remember that meals are delivered the day before they appear on the menu.)

WEEK 4 - Effective: July 19, 2021

	MONDAY:	TUESDAY:	WEDNESDAY:	THURSDAY:	FRIDAY:	SATURDAY:	SUNDAY:
8 OZ. MILK	1 % MILK	1 % MILK	1 % MILK	1 % MILK	1 % MILK	1 % MILK	1 % MILK
BREAD OR CEREAL EQUIVALENT 1 SERVING	(1) - 0.69 OZ. RAISIN BRAN CEREAL BOWL PACK	(1) - 1.25 OZ. SPECIAL-K CEREAL BOWL PACK	(1) WHOLE WHEAT ENGLISH MUFFIN	(1) - 1.25 OZ. ALL BRAN CEREAL BOWL PACK	(1) - 3/4 CUP TOTAL CEREAL BOWL PACK	(1) - 0.69 OZ. 40 % BRAN FLAKES CEREAL BOWL PACK	
OPTIONAL 2nd SERVING BREAD OR CEREAL EQUIVALENT	(1) WHOLE WHEAT ENGLISH MUFFIN	(2) SLICES WHOLE WHEAT BREAD	(1) LOW FAT CEREAL BAR	(1) WHOLE WHEAT ENGLISH MUFFIN	(1) - 3.6 OZ. BANANA BREAD MUFFIN	(2) SLICES WHOLE WHEAT BREAD	(1) - 3.6 OZ. BRAN BREAD MUFFIN
FRUIT OR JUICE 1/2 CUP	(1) CUP CANTALOUPE	(1) FRESH ORANGE (1) - 4 OZ. APPLE JUICE	(1) FRESH ORANGE	(1) FRESH ORANGE	(1) FRESH BANANA (1) - 4 OZ. ** ORANGE JUICE	(1) FRESH BANANA	(1) FRESH ORANGE
MARGARINE 1 SERVING	(1) PC JELLY	(1) MARGARINE REDDIE PC.	(1) MARGARINE REDDIE PC	(1) MARGARINE REDDIE PC.	(1) MARGARINE REDDIE PC.	(2) MARGARINE REDDIE PC.	
OTHER FOODS	(1) - 4 OZ. * FRUITED YOGURT		(2) - 4 OZ. * FRUITED YOGURT	(1) HARD BOILED EGG	(1) - 3/4 CUP or 6 OZ. COTTAGE CHEESE	(2) - 4 OZ. * FRUITED YOGURT	(1) - 8 OZ. COTTAGE CHEESE
ADDITIONAL FOOD ITEMS	(1) HARD BOILED EGG	(2) - 4 OZ. * FRUITED YOGURT		(2) - 4 OZ. * FRUITED YOGURT			

\* Fruited Yogurt flavors are: Strawberry, Blueberry, Peach and Strawberry/Banana

\*\* Orange Juice is - Calcium Fortified

DIETITIAN SIGN-OFF: Mary M. Underwood, MS, RD, LD, CNSC  
 W/ NUTRITIONAL ANALYSIS NO 7257  
 LICENSE #:

AGENCY  
 DIETITIAN SIGN-OFF:  
 LICENSE #:

DATE: 10/2/21

DATE:

**City of Miami Springs**

Shelf Stable Menu – Cycle 2 July 19, 2021 - January 16, 2022

<b>Box 1</b>	<b>Box 2</b>	<b>Box 3</b>	<b>Box 4</b>	<b>Box 5</b>
5oz. Can Chicken Breast 6oz. Can Mixed Veg 4oz Peach Cup in Juice 6oz. V8 Veg Juice 2 pk Low Salt Saltine Crackers 2 T. Mayonnaise 8oz. 1% Shelf Stable Milk	7.5oz Can Beef Ravioli 6oz. Can Corn 4oz Pears in Juice 6oz. Orange Juice 2pk Low Salt Saltine Crackers 8oz. 1% Shelf Stable Milk	3.5oz Can Tuna 6oz. Can Mixed Veg 6oz. V8 Veg Juice 4oz Can Mandarin Orange in Juice 2pk Low Sodium Saltine Crackers 2pk Mayonnaise 8oz. 1% Shelf Stable Milk	4.75oz. Can Chicken Vienna Sausage 6oz. Can Mixed Veg 4oz. Applesauce 6oz. Can V8 Veg Juice 1 Granola Bar/Fiber One 2pk Low Salt Saltine Crackers 8oz. 1% Shelf Stable Milk	4.3oz Sardines in Water 10¾ oz Low Sodium Chicken Noodle Soup 4oz. Peaches in Juice 6 oz. Can V8 Veg Juice 2pk Low Salt Saltine Crackers 3.5oz Tapioca Pudding 8oz. 1% Shelf Stable Milk

109

Dietitian Signature: Michelle Larea

Date: 05/18/21

## City of Miami Springs

Boxed Lunches Menu – Cycle 2 July 19, 2021 - January 16, 2022

Box 1	Box 2	Box 3	Box 4	Box 5
1 ea. Cuban Sandwich with 3 oz. Pork, Ham, & Swiss Cheese & tomato 1 pk. Plantain Chips ¼ c. Raw Carrots 1 ea. Fresh Seasonal Fruit (Banana) 8 oz. 1% Low fat Milk	1 ea. Midnight Sandwich with Whole Wheat Bun 3 oz. Pork, Ham, & Swiss Cheese 1 pk. Plantain Chips ½ c. Three Bean Salad 1 pkt. Lite Mayo & Mustard 1 ea. Fresh Seasonal Fruit (banana) 8oz. 1% Low Fat Milk	1oz. Ham, 1oz Salami & 1oz Provolone Cheese on Whole Grain Onion Bun and a Slice of Tomato 1 pk. Plantain chips ¼ c. Raw carrots 1 pkt. Mustard 1 ea. Fresh Seasonal Fruit (Orange) 8oz. 1% Low Fat Milk	3 Cheese Sandwich, 1oz ea. Provolone, Swiss, American and a slice of tomato on WW Sliced Bread 1 pk. Baked Potato Chips ¼ c. Raw Carrots 1 pkt. Lite Mayonnaise & Mustard 1 ea. Fresh Seasonal Fruit (Orange) 8oz. 1% Low Fat Milk	3 oz. 2 ea. Ham Croquette W/1oz. Swiss cheese on a Cuban roll 1 pk. Plantain chips ¼ c. Sliced Pickles 1 pkt. Lite Mustard 1 ea. Fresh Seasonal Fruit (Orange) 8 oz. 1% Low Fat Milk

Dietitian Signature: \_\_\_\_\_ Michelle Larea

Date: \_\_\_\_\_ 05/18/21 \_\_\_\_\_

110

## City of Miami Springs

Special Event & Holiday Menu – Cycle 2 July 19, 2021 - January 16, 2022

Summer BBQ Meal	Special Event #1	Thanksgiving Meal	Christmas Meal	New Year's / Special Event #2
Choice of: 3oz. Hamburger or 3oz. Hot Dog 1 ea. Whole Wheat Bun ½ c. Corn ½ c. Baked Beans ½ c. Lettuce & Tomato 1 ea. Cupcake 4oz. Lemonade 8 oz. 1% Milk 1 ea. Mustard & Ketchup	8oz. Arroz Imperial with 3oz. Chicken, ½ oz. Mozzarella Cheese, and ½ c. Yellow Rice ½ c. Fried Plantains ½ c. Mixed Green Salad with Tomato, Cucumber & Carrots 1 T. Lite Italian Dressing ½ c. Flan 8 oz. 1% Milk	3oz. Turkey with 1oz Gravy & 1oz. Cranberry Sauce ½ c. Stuffing ½ c. Green Bean Almondine ½ c. Mashed Potatoes 1 ea. Cornbread 1 sl. Pumpkin Pie 8 oz. 1% Milk	3oz. Pork with 1oz Mojo ½ c. White Rice & Black Beans ½ c. Yuca with ½ oz. Mojo 1 c. Tossed Salad 1 T. Lite Dressing 1 ea. Cuban Roll 1 sl. Christmas Cake 8 oz. 1% Milk	3oz. Chorizo Stuffed Boliche ½ c. Moros ½ c. Oven Fried Plantains 1 c. Spinach & Tomato Salad 1 T. Lite Dressing 1 ea. Cuban Roll ½ c. Grapes ½ c. Flan 8 oz. 1% Milk

Dietitian Signature: \_\_\_\_\_ Michelle Larea \_\_\_\_\_

Date: \_\_\_\_\_ 05/18/21 \_\_\_\_\_

///

## SPECIAL PICNIC LUNCH

A special picnic lunch may be ordered by any site to replace the menu regularly scheduled for that day.

Vendor will prepare special picnic lunch for any site that gives at least three (3) days notice. The site will specify their requests for their desired meal when the initial request is made.

Milk: 8 oz. - 2 % low fat

### Entrée

Choices:  
(3 oz.) baked chicken - quartered  
par boiled chicken - quartered  
fresh chicken - quartered  
4 oz. hamburger patties and buns  
2 - 2 oz. hot dogs and buns

### Vegetable:

(½ cup) sliced carrots and celery sticks  
sliced tomatoes and lettuce  
southern baked beans

Potato: ½ cup Potato salad  
½ cup Cole slaw

Bread: Hot dog buns, hamburger buns

Condiments: Mustard, ketchup - p.c.'s as necessary relish, pepper  
p.c. 4 oz. Fruit Juice  
Milk to come iced, in sturdy container

All paper goods 5 compartment trays

3-ply Napkins  
Knives (Cellophane Wrapped)  
Forks  
Straws

Center may choose to have any portion of the meal delivered in box lunch containers. These arrangements will be individually made.



# Master Host • Greater Miami Caterers, Inc.

LANDMARKS IN THE FOOD SERVICE INDUSTRY

4001 N.W. 31st AVE., MIAMI, FLORIDA 33142 • P.O. BOX 520752, MIAMI, FLORIDA 33152  
(305) 633-8066 • (305) 633-4616 • Broward (954) 927-3266 • Fax (305) 635-5202



## LIST OF LIKE FOOD SUBSTITUTES

Greater Miami Caterers is herewith establishing parameters for substitutions of permanent menu items upon their unavailability according to department of elder affairs standard of operating procedures. These substitute items will be in accord with guidelines documented in section 5-9, menu review and approval, Chapter IV-5, Title III-C Nutrition Program policies in the Department Of Elder Affairs programs and services manual.

We propose the following as like substitutes.

- (1) One - 3oz. Cooked edible portion meat, fish or fowl -salisbury steak, roast beef, baked filet of fish, fried fish square, baked chicken or roast turkey.
- (2) Two - one-half cup servings vegetable, fruit or juice - mashed potatoes, oven brown potatoes, green beans, chopped spinach, fresh apple, fresh orange, apple juice or orange juice.
- (3) One serving whole grain or enriched bread or alternative - white bread, wheat bread, bun, saltine crackers, dinner roll, macaroni or white rice.
- (4) One teaspoon butter or margarine - butter for margarine or visa versa.
- (5) One - one-half cup serving dessert - fresh apple, diet pear halves, diet fruit cocktail, fresh orange or diet applesauce.
- (6) 8 oz. Of whole, skim or low-fat milk - whole milk, 2% low-fat milk or skim milk.

This list of like substitutions will stand on file in lieu of its usage upon demand.

Please call if you have any questions and thank you for your consideration.



## Pre-Approved Menu Substitutions

### **Protein:**

The following may be served in place of each other in the required portion size and cooked in the same or similar manner as the protein dish that is being substituted:

**Beef, pork, fish, chicken, turkey, ham, egg or egg dishes**

**Meats or protein containing tomato sauce that can substitute for each other: ropa vieja, picadillo, beef stew, pork in tomato sauce, chicken fricassee, turkey fricassee.**

**Beans and Legumes that can substitute for each other: Red Beans, Lentils, Split Pea, Black Beans, White Beans, Caldo Gallego (Galician Bean Soup), Guiso (Corn Soup Spanish Style), Pinto Beans, Chick Peas Soup.**

### **Brown Rice:**

If brown rice on the menu is substituted by white rice or mashed potatoes or any other rice dish ("conгри, moros", etc.), to maintain the integrity of the fiber content for that meal, a whole wheat dinner roll or whole wheat bread must be added to the meal. If this meal already includes a whole wheat roll or bread, then 2 rolls or breads would be served.

### **Vegetables (Category 1):**

The following group of vegetables may be used in place of each other in the required portion:

Carrots, peas & carrots, tomato juice, tomatoes, frozen mixed vegetables, vegetable medley, winter squash, pumpkin, sweet potatoes, broccoli, mixed vegetables juice, and

Pre-Approved Menu Substitutions – Page 2

tomato paste or puree. Vegetable Soup or Minestrone Soup (1 cup) may also be used in place of any of these vegetables.

**Vegetables (Category 2):**

The following vegetables may be used in place of each other in the required portion size:

Broccoli, brussel sprouts, cabbage, sweet peppers, spinach, cauliflower, coleslaw, okra, potatoes, sweet potatoes, tomatoes, tomato juice.

**Vegetable Soups:**

Vegetable soup, minestrone soup, pumpkin soup, squash soup and similar soups may be used in place of each other in the required portion size.

**Fruits (Category 1):**

The following fruits may be used to substitute for each other in the required portion:

Oranges, orange juice, grapefruit, grapefruit juice, tangerines, cantaloupe, citrus fruit cup, strawberries, mango, guava, citrus fruit cup.

**Fruits (Category 2):**

The following fruits may be used to substitute for each other in the required portion:

Apricots, prunes, plums, peaches, nectarines, cantaloupe, papaya, mango, sour cherries, canned peaches, canned pears, canned fruit cocktail, canned fruit mix.

**Complex Carbohydrates:**

The following foods may be used to substitute for each other in the required portion: white rice, yellow rice, rice pilaf, yellow rice with vegetables, mashed potatoes, baked or boiled potatoes, mashed sweet potatoes, baked or boiled sweet potatoe, yucca, malanga, plantain.

Pre-Approved Menu Substitutions – Page 3

**Breads:**

Whole wheat roll, whole wheat bread, whole grain bread and whole grain roll may be used in place of each other in the required portion.

White bread, dinner rolls, garlic rolls, Cuban bread, garlic bread, and French

Bread or French baguettes may be used in place of each other in the required Portions.

**Milk:**

Pre-Approved Menu Substitutions

If the 1% fat milk needs to be substituted on the menu, it is acceptable to replace it with 2% fat milk occasionally. It could also be substituted with skim milk on occasion.

**Desserts:**

The following desserts may substitute for each other in the required portion:

Vanilla pudding, chocolate pudding, custard, rice milk pudding, tapioca, ice cream, cheesecake, flavored yogurt.

**Other desserts:**

The following desserts may substitute for each other in the required portion:

Cakes, fruit pies, guava pastry

**Formal sanitation program and checklists, HACCP programs and other food safety programs**



# Master Host • Greater Miami Caterers, Inc.

LANDMARKS IN THE FOOD SERVICE INDUSTRY

4001 N.W. 31st AVE., MIAMI, FLORIDA 33142 • P.O. BOX 520752, MIAMI, FLORIDA 33152  
(305) 633-8066 • (305) 633-4616 • Broward (954) 927-3266 • Fax (305) 635-5202



## FORMAL SANITATION PROGRAM

This document addresses the methods that Greater Miami Caterers utilizes to comply with the regulations developed by the department of business regulation and the division of agriculture and consumer affairs which are regarded as the governing bodies which inspect and regulate caterers.

Described below are the procedures taken to operate a large scale food service operation which provides quality food products and has proven inspection grades.

Also take note that Greater Miami Caterers was the first South Florida caterer to develop this program over twenty years ago and since its inception our competitors have sought to plagiarize our program rather than develop one of their own. Upon review, you will notice similarities in our long standing program and what our inept competition claims as their own.

### 1. Food sources

- A. Inspect all products delivered to Greater Miami Caterers to verify their integrity, sound condition, for spoilage and that it is properly labeled.

### 2. Food protection

- A. Regularly check to see that potentially hazardous food meets temperature requirements during storage, preparation and transportation.
- B. Provide thermometers conspicuously.
- C. Follow proper thawing methods: 1) under running water or 2) in refrigeration.
- D. Verifying that foods are properly protected and wrapped during storage, preparation and transportation.
- E. Establish proper storage procedures of food dispensing utensils.

### 3. Personnel

- A. Restrict access to food of personnel with infections or contagious diseases.
- B. Employees must follow routine hand washing habits and good hygienic practices.
- C. Employees are to wear clean clothes and proper hair restraint.
- D. Dressing room provided is maintained clean and are readily accessible.

### 4. Food equipment and utensils

118

- A. All food and non-food contact surfaces of all equipment and utensils including dish washing facilities must be properly designed for its use, constructed well and maintained in good working order, properly installed and located in an efficient working environment.
- B. Provide chemical test kits conspicuously for sanitizing water testing.
- C. Establish proper washing methods of scrapping and/or soaking, soapy water, rinse water and sanitizing solution.
- D. Providing clean wiping cloths and follow proper storage methods.
- E. Store single-service articles off the floor and protect from contamination with no reuse of them.

5. Water, sewage and plumbing

- A. To provide a safe and uncontaminated hot and cold water source under pressure.
- B. Provide for means of disposal of sewage and waste water through properly installed and maintained plumbing lines.
- C. Installing back flow preventions on all water outlets where applicable.

6. Toilet and hand washing facilities

- A. Establishing sufficient numbers of the above which are readily accessible, properly designed and installed with self-closing doors, adequate fixtures in good clean repair with sanitary towels for hand drying and with waste receptacles.

7. Garbage and refuse disposal

- A. Providing outside refuse collectors which are covered with sufficient capacity for the volume of garbage generated which are insect and rodent proof, leak proof and frequently cleaned.

8. Insect, rodent and animal control

- A. Provide for a work area which has no presence of the above and is accomplished thru u.s.d.a. Approved chemicals by an established and quality pest management firm.

9. Floors, walls, ceilings, lighting and ventilation

- A. All floors, walls and ceilings must be properly constructed, in good repair with clean surfaces including any equipment attached.
- B. Floors should pitch or contain floor drains to provide for proper drainage of liquids.
- C. Lighting should be throughout and pervasive to provide a visually safe working environment.
- D. All lighting equipment should be either of shatter proof materials or properly shielded.

- E. All rooms and equipment contained in our building is to be properly ventilated to prevent from excessive heat build-up or airborne fumes of cleaning chemicals to provide a comfortable and safe work environment.

10. Other operations

- A. Activities which make use of toxic items are handled only by properly trained employees which functionalize the storage, use and identification of the labeling of the products.
- B. Our premises are maintained free of litter, without unnecessary articles in work areas and with cleaning maintenance equipment properly used in its area and stored.
- C. Providing a proper receptacle for soiled towels, aprons and other linens.

11. Safety

- A. Hand held fire extinguishers are conspicuously available throughout the building with current inspection tags.
- B. The overhead hood extinguisher system is to be properly installed and maintained with current inspection tags.
- C. Exits to building are clearly identifiable and readily accessible.
- D. All electrical wiring and gas appliances are to be properly designed and installed, of adequate capacity and in good repair.
- E. All flammable or combustible materials are to be properly stored.

12. General

- A. Posting of all current licenses in a conspicuous place, properly displayed with a valid food management certification.
- B. Complying with all facets of the clean indoor air act.
- C. Establish high integrity in the publishing and/or advertisements related to food and beverage services offered which may provide false or misleading statements to the general public.

These twelve topics constitute Greater Miami Caterers formal sanitation program. If any further clarifications are needed, please do not hesitate in calling John Olmo, Vice-President at 633-4616. Thank you for your consideration.

GREATER MIAMI CATERERS /MASTER HOST  
4001 NW 31 AVENUE MIAMI FL,33142

**WEEKLY THERMOMETERS CALIBRATING LOG**

DATE:

EMPLOYEE'S NAME	TIME.	THERM. READ AT	CORRECTIVE ACTION	CALIBRATOR SIGNATURE
<b>DEPT. COOKS</b>				
KENNETH ST LOUIS				
JAMAINE PACE				
DARRIST ALSTON				
HECTOR BANOS				
<b>DEPT. ELDERLY MEALS</b>				
JOSE LOPEZ				
BRIGITTE NAVARRETE				
<b>DEPT. SUPERVISORS</b>				
JORGE GUTIERREZ				
JOSE LOPEZ				
DENNIS STONESTRRET				



GREATER MIAMI CATERERS, INC.  
4001 NW 31 AVENUE MIAMI FL,33142

**DAILY SANITATION CHECK LIST**

Employee Health Practices		Description
1	Workers ill with food borne agents;open or infected wounds	<input type="checkbox"/> Yes <input type="checkbox"/> No
2	Good hygienic Clean clothes, clean aprons	<input type="checkbox"/> Yes <input type="checkbox"/> No
3	Hygienic practices; gloves, hair restraints,clean hands	<input type="checkbox"/> Yes <input type="checkbox"/> No
4	Personal items exposed to food or food equipment areas	<input type="checkbox"/> Yes <input type="checkbox"/> No
5	Employee working with unnecessary jewelry	<input type="checkbox"/> Yes <input type="checkbox"/> No
Food & Prevention of Cross Contamination		Description
6	Plant layout & equipment suitable to minimize contamination	<input type="checkbox"/> Yes <input type="checkbox"/> No
7	Utensils clean and sanitized before contacting any food product	<input type="checkbox"/> Yes <input type="checkbox"/> No
8	Wiping towels properly stored in sanitizer level	<input type="checkbox"/> Yes <input type="checkbox"/> No
9	Foods properly date, marked or labeled	<input type="checkbox"/> Yes <input type="checkbox"/> No
10	All foods properly cover	<input type="checkbox"/> Yes <input type="checkbox"/> No
11	All cooked food properly cover	<input type="checkbox"/> Yes <input type="checkbox"/> No
12	Properly thawed of meats,poultry or frozen foods	<input type="checkbox"/> Yes <input type="checkbox"/> No
13	Raw food storage in the bottom shelves	<input type="checkbox"/> Yes <input type="checkbox"/> No
14	Cross contamination at storage	<input type="checkbox"/> Yes <input type="checkbox"/> No
15	Cross contamination at equipment	<input type="checkbox"/> Yes <input type="checkbox"/> No
16	Personnel Cross contamination	<input type="checkbox"/> Yes <input type="checkbox"/> No
17	Employee on raw side wash hands or change gloves frequently	<input type="checkbox"/> Yes <input type="checkbox"/> No
18	Employee on cooked side wash hands or change gloves frequently	<input type="checkbox"/> Yes <input type="checkbox"/> No
Facilities and Equipment.		Description
19	Store of single sevice items, boxes,trays,cans off the floor	<input type="checkbox"/> Yes <input type="checkbox"/> No
20	Food contact surfaces clean; in good repair	<input type="checkbox"/> Yes <input type="checkbox"/> No
21	Non-food contact surfaces clean; in good repair	<input type="checkbox"/> Yes <input type="checkbox"/> No
22	Dishwashing facilities functioning properly	<input type="checkbox"/> Yes <input type="checkbox"/> No
23	Wiping towels properly stored in sanitizer level	<input type="checkbox"/> Yes <input type="checkbox"/> No
24	Lighting shielded and working properly	<input type="checkbox"/> Yes <input type="checkbox"/> No
25	Floors,walls,ceiling,attached equipment clean	<input type="checkbox"/> Yes <input type="checkbox"/> No
26	Floors,walls,ceiling,attached equipment needs repair	<input type="checkbox"/> Yes <input type="checkbox"/> No

Water, Plumbing, Waste.		Description
27	Ice equipment properly maintained and cleaned	<input type="checkbox"/> Yes <input type="checkbox"/> No
28	Handwash sinks equipped with hot water paper towels, hand soap	<input type="checkbox"/> Yes <input type="checkbox"/> No
29	Sanitary facilities properly maintained, toilet paper, hand soap etc.	<input type="checkbox"/> Yes <input type="checkbox"/> No
30	Water back flow working properly	<input type="checkbox"/> Yes <input type="checkbox"/> No
31	Water leaks	<input type="checkbox"/> Yes <input type="checkbox"/> No
32	Trash cans properly clean & cover	<input type="checkbox"/> Yes <input type="checkbox"/> No
Vermin control		Description
33	Presence or evidence of vermin	<input type="checkbox"/> Yes <input type="checkbox"/> No
34	Outer openings protected from vermin	<input type="checkbox"/> Yes <input type="checkbox"/> No
35	Outer grounds free of litter, junk & other pest harborage areas	<input type="checkbox"/> Yes <input type="checkbox"/> No
Safety		Description
36	Fire suppression, extinguishers properly charge y ready to use	<input type="checkbox"/> Yes <input type="checkbox"/> No
37	Electrical and gas appliances working properly	<input type="checkbox"/> Yes <input type="checkbox"/> No
38	Chemical compounds properly labeled, stored and use	<input type="checkbox"/> Yes <input type="checkbox"/> No
39	All toxic compounds properly labeled, stored and use	<input type="checkbox"/> Yes <input type="checkbox"/> No
Other		Description
		<input type="checkbox"/> Yes <input type="checkbox"/> No
		<input type="checkbox"/> Yes <input type="checkbox"/> No
		<input type="checkbox"/> Yes <input type="checkbox"/> No
		<input type="checkbox"/> Yes <input type="checkbox"/> No

Corrective action taken.

1 \_\_\_\_\_

2 \_\_\_\_\_

3 \_\_\_\_\_

4 \_\_\_\_\_

5 \_\_\_\_\_

6 \_\_\_\_\_

7 \_\_\_\_\_

8 \_\_\_\_\_

9 \_\_\_\_\_

SIGNATURE: \_\_\_\_\_

DATE: \_\_\_\_\_

TITLE: \_\_\_\_\_

TIME: \_\_\_\_\_

GREATER MIAMI CATERERS  
DAILY SANITATION CHECK LIST

	PRE OP. TIME	MID. DAY TIME	POST OP. TIME	COMMENT & CORRECTION
<b>Protection from adulterants &amp; storage toxic compounds</b>				Plant layout & equipment suitable to minimize risk of contamination; separation of operations
				Lubricants, cleaning compounds, pesticides id'd & stored separate from food & food ingredients
				Overhead light fixtures properly protected; cleaning equipment properly stored & maintained
<b>Toilet facilities &amp; exclusion of pest &amp; grounds</b>				Grounds free of litter, high weeds , junk & other pest harborage areas; trash pick up
				No evidence of insect, pest or redent problems. Maintenance of bait stations
				Toilet facilities properly maintained, hot water, hand cleaning soap / sanitizer, paper towels
<b>Safety of water, plumbing to code</b>				Plumbing sized, installed & maintained to sanitari code. No cross-connection between process & waste water systems
				Water supply aproved/ tested; ice supply clean & protected & ice equipment properly maintained / cleaned

SIGNATURE: \_\_\_\_\_

DATE: \_\_\_\_\_

TITLE: \_\_\_\_\_

124

GREATER MIAMI CATERERS  
DAILY SANITATION CHECK LIST

		PRE OP. TIME	MID. DAY TIME	POST OP. TIME	COMMENT & CORRECTION
<b>Conditions &amp; cleanliness of food contact surfaces</b>	Equipment cleaning & sanitizing ( Including food transport Equipment )				
	Process interruptions - cleaning & sanitizing ( describe time period & action taken )				
	Concentration of sanitizer used for equipment				
<b>Prevention of cross-contamination &amp; maintenance of hand wash &amp; sanitizing</b>	Employee on raw side wash & sanitize hands, gloves				
	utensils cleaned & sanitizad before moving to cooked side				
	Concentration of sanitizar in hand dip ( ppm ) checks				
	stations # 1 - 2				
	stations # 3 -4				
	Product containers, raw materials , In - process & finished product protected from floor splash, condensate, ect				
<b>Employee health practices</b>	Employee with illness, open or infected wounds not allowed in contact with foods or food contact operations				
	Store clothing or personal items out of exposed food & food equipment areas				
	Only authorized persons in food process area. Employees with clean uniforms & hair covers				

SIGNATURE: \_\_\_\_\_

DATE: \_\_\_\_\_

TITLE: \_\_\_\_\_

125



# HACCP PLAN FOR FROZEN FILET FISH OTHER THAN MAHI-MAHI (IE. WHITEFISH, TILAPIA, COD, FLOUNDER, PAN GASTIUS, SANMI & SALMON) Control Strategy - Time/Temperature Control

Critical Control Point (CCP)	Significant Hazard (s)	Critical Limits for each Preventive Measure	Monitoring			Corrective Action (s)	Records	Verification
			What	How	Frequency			
Receiving and Storage	Pathogen growth and toxin formation	> Product is to arrive in a completely frozen state of 25°F or less  > Freezer maintained at or below 20°F	Frozen Fish  > Freezer temperature	Visually, if in question, with digital or spike temperature thermomete  > Digital time / temperature data logger	Upon receiving of delivery with computer generated notifications to e-mail and cell phone of deviations with a visual check of the recorded data at least once daily	Inventory manager or inventory assistant  > Notification recipients of e-mails and cell calls	Receiving Record  > Data logger daily printout with daily visual check sign off	Review monitoring and corrective actions with inventory controller records monthly  Check the digital or spike thermometer for accuracy and damage and to ensure that it is operational before putting it into operation, perform these same checks daily, and calibrate it once per year or dispose of the thermometer  Review log and corrective actions weekly  Check accuracy of continuous monitoring data logger against a standard NIST thermometer once monthly
Cooking	Pathogen Survival	Oven Temperature length as per product schedule to reach a minimum internal temperature of 158° F for a minimum of 15 sec.	Time and temperature of cooking process	Visually with timer or clock and a digital or spike thermometer	Each Batch	Chef	Cooks record	Review cooks record daily by supervisor who initials and dates  Check the digital or spike thermometer for accuracy and damage and to ensure that it is operational before putting it into operation, perform these same checks daily, and calibrate it once per year or dispose of the thermometer
Cooling Cooked Product	Pathogenic bacteria growth and toxin formation due to time / temperature abuse	Fish to be cooled from 135 degrees F to 70 degrees F in 2 hours and 70 degrees F to 40 degrees F in 4 more hours  > Cooler maintained at or below 40°F	Cooked fish internal temperature  > Cooler temperature	Visually with timer or clock and a digital or spike thermometer  > Digital time / temperature data logger	Start with marked containers upon storage and then every 2 hours  > Continuous monitoring with computer generated notifications to e-mail and cell phone of deviations with a visual check of the recorded data at least once daily	Production supervisor or trained staff person  > Notification recipients of e-mails and cell calls	Cooling Chart  > Data logger daily printout with daily visual check sign off	Review cooling chart record within 1 week by supervisor who initials and dates  Check the digital or spike thermometer for accuracy and damage and to ensure that it is operational before putting it into operation, perform these same checks daily, and calibrate it once per year or dispose of the thermometer  > Review log and corrective actions weekly  Check accuracy of continuous monitoring data logger against a standard NIST thermometer once monthly

127

Finished Product Storage After Cooling	Pathogenic bacteria growth and toxin formation due to time / temperature abuse	> Cooler maintained at at or below 40°F	> Cooler temperature	> Digital time / temperature data logger	> Continuous monitoring with computer generated notifications to e-mail and cell phone of deviations with a visual check of the recorded data at least once daily	> Notification recipients of e-mails and cell calls	> Move product to a different cooler that is temperature compliant  Also contact refer service rep if inadequate temps persist for more than 2 hours	> Data logger daily printout with daily visual check sign off	> Review log and corrective actions weekly  Check accuracy of continuous monitoring data logger against a standard NIST thermometer once monthly
Preparation for Distribution to customer	Pathogenic bacteria growth and toxin formation due to time / temperature abuse	Reheating of product to reach a minimum internal temperature of 165° F for a minimum of 15 seconds	Time and temperature of re-heating process	Visually with timer or clock and a digital or spike thermometer	A 4% sampling of a batch of containers	Re-heating crew	Continue reheating until critical limit is reached or exceeded and to add 3 minutes incrementally to standard reheating time for each time the fish is checked and still under minimum temperature of 165 degrees F	Reheating Foods Log	Heating crew supervisor visually verifies temperatures along side staff personnel when product is exiting oven and staff logs the temperature monitored  Check the digital or spike thermometer for accuracy and damage and to ensure that it is operational before putting it into operation; perform these same checks daily; and calibrate it once per year or dispose of the thermometer
Distribution to customer including packaging	Pathogenic bacteria growth, toxin formation due to time / temperature abuse and listing of Allergens / Additives	Maintain temperature until delivery at no less than 140° F	Temperature upon delivery	Thermometers at customer sites	Daily upon delivery	Customer site representative and company delivery person	If temperature is under product and the incident is logged on a Customer Temperature Deficiency Log and the cause is investigated for needed adjustments to reheating procedures	Customer Temperature Deficiency Log	Delivery personnel confirms temperature deficiency on site with company issued thermometer  Check the digital or spike thermometer for accuracy and damage and to ensure that it is operational before putting it into operation; perform these same checks daily; and calibrate it once per year or dispose of the thermometer
		Packaging to include labeling of potential inclusion of any of the eight major food allergens or additives	Label on meal packaging identifying fish as the allergen & any other additives or allergens	Visually	For every bulk food item and individually plated meal that is packaged	By line food packaging staff	Immediately place missing label on meal or food item and investigate the labeling omission for the cause and corrective action needed to prevent future events	All labels applied as well as any corrected deviations are recorded on the "Label Application & Corrective Action Log" (LACAL)	Supervisor reviews log and corrective actions taken, if any needed, within 1 week and signs and dates the review

SIGNATURE AND DATE

128

# HACCP PLAN for SHELL FISH

## Control Strategy - Time/Temperature Control

Critical Control Point (CCP)	Significant Hazard (s)	Critical Limits for each Preventive Measure	Monitoring			Corrective Action (s)	Records	Verification
			What	How	Who			
Receiving and Storage	Pathogen growth and toxin formation	> Product is to arrive in a completely frozen state of 25°F or less  > Freezer maintained at or below 20°F	Frozen Shellfish  > Freezer temperature	Visually, if in question, with spike temperature thermometer  > Digital time / temperature data logger	Inventory manager or inventory assistant  > Notification receipts of e-mails and cell calls	Return to Vendor if not in solid state  > Move product to a different freezer that is temperature compliant  Also contact refer service rep if inadequate temps persist for more than 2 hours	Receiving Record  > Data logger daily printout with daily visual check sign off	Review monitoring and corrective actions with inventory controller records monthly  Check accuracy of spike thermometer monthly  > Review log and corrective actions weekly  Check accuracy of continuous monitoring data logger against a standard NIST thermometer once monthly
Cooking	Pathogen Survival	Oven or Fryer temperature and length as per product schedule to reach a minimum internal temperature of 158 F for a minimum of 15 seconds.	Time and temperature of cooking process	Visual, timer and spike temperature thermometer	Chef	Continue cooking until critical limit is reached	Cooks record	Review cooks record monthly  Check accuracy of spike thermometer monthly
Cooling Cooked Product	Pathogen growth, scombrotoxin formation (histamine) and toxin formation due to time / temperature abuse	> Fish to be cooled from 145°F to 75°F in 2 hours or less  > Cooler maintained at or below 38°F	Cooked fish  > Cooler temperature	Spike Temperature thermometer  > Digital time / temperature data logger	Production supervisor or trained staff person  > Notification receipts of e-mails and cell calls	Place in freezer to cool quicker  > Move product to a different cooler that is temperature compliant  Also contact refer service rep if inadequate temps persist for more than 2 hours	Cooks record  > Data logger daily printout with daily visual check sign off	Review cooks record monthly  Check accuracy of spike thermometer monthly  > Review log and corrective actions weekly  Check accuracy of continuous monitoring data logger against a standard NIST thermometer once monthly
Finished Product Storage After Cooking	Pathogen growth, scombrotoxin formation (histamine) and toxin formation due to time / temperature abuse	> Fish to be cooled from 75 F to 38 F in 2 hours or less  > Cooler maintained at or below 38°F	Cooked fish  > Cooler temperature	Spike Temperature thermometer  > Digital time / temperature data logger	Production supervisor or trained staff person  > Notification receipts of e-mails and cell calls	Divide fish into smaller lots so refrigeration can penetrate quicker and / or place in freezer to quickly cool and either destroy product or perform histamine analysis  > Move product to a different cooler that is temperature compliant  Also contact refer service rep if inadequate temps persist for more than 2 hours	Cooks record  > Data logger daily printout with daily visual check sign off	Review cooks record monthly  Check accuracy of spike thermometer monthly  > Review log and corrective actions weekly  Check accuracy of continuous monitoring data logger against a standard NIST thermometer once monthly
Preparation for Distribution to customer	Pathogen growth, scombrotoxin formation (histamine) and toxin	Reheating of product to reach a minimum internal temperature of	Time and temperature of re-heating process	Visual, timer and spike temperature thermometer	Re-heating crew	Continue re-heating until CL is reached or exceeded	Customer's Daily Delivery Slip	Heating crew supervisor visually verifies temperatures along side

129





# HACCP PLAN for FROZEN BREADED FISH PRODUCT

(IE. WHITEFISH, POLLACK, TALAPIA, SWAI, COD, FLOUNDER, GROUPEL & CATFISH)

## Control Strategy - Time/Temperature Control

Critical Control Point (CCP)	Significant Hazard (s)	Critical Limits for each Preventive Measure	Monitoring			Corrective Action (s)	Records	Verification
			What	How	Frequency			
Receiving	Pathogen growth and toxin formation	> Product is to arrive in a completely frozen state of 25°F or less	Frozen Fish	Visually, if in question, with spike thermometer	Upon receiving of delivery	Inventory manager or inventory assistant	Return to Vendor if not in solid state	Review monitoring and corrective actions with inventory controller records weekly  Check accuracy of spike thermometer monthly
Storage	Pathogen growth, scombrotoxin formation (histamine) and toxin formation due to time / temperature abuse	> Freezer maintained at or below 25°F	> Freezer temperature	> Digital time / temperature data logger	> Continuous monitoring with computer generated notifications to e-mail of deviations with a visual check of the recorded data at least once daily	> Notification recipients of e-mails	> Move product to a different freezer that is temperature compliant  Also contact refer service rep if inadequate temps persist for more than 2 hours	> Review log and corrective actions weekly  Check accuracy of continuous monitoring data logger against a standard NIST thermometer once monthly
Cooking	Pathogen Survival	Deep Frying Temperature length as per instructions on product packaging or to reach a minimum internal temperature of 145° F for a minimum of 15 seconds, whichever process is greater.  Maintain temperature until delivery at no less than 140° F	Time Temperature of cooking process	Visual and timer or spike temperature thermometer	Each Batch	Chef	Continue cooking until critical limit is reached	Review cooks record weekly  Check accuracy of spike thermometer monthly
Distribution to customer including packaging	Pathogen bacterial growth, toxin formation due to time / temperature abuse and Allergen / Additives	Packaging to include labelling of any potential inclusion of any of the eleven major food allergens or prohibited additives	Temperature upon delivery  Label on container identifying milk, egg, wheat, soy and fish as the allergens	Thermometers at customer sites  Visually	Upon delivery  For every label produced for packaging	Customer site representative  By line food packaging staff	If temperature is under, customer calls GMC for replacement of product  Immediately place missing label on meal	Delivery personnel confirms customer's temperature reading on site  Any observed and corrected deviations are recorded on a "Labeling Corrective Action Log" (LCAL)

SIGNATURE AND DATE

131

## HACCP PLAN FOR TUNA SALAD Control Strategy - Time/Temperature Control

Critical Control Point (CCP)	Significant Hazard (s)	Critical Limits for each Preventive Measure	Monitoring			Corrective Action (s)	Records	Verification
			What	How	Frequency			
Receiving	Pathogen growth and toxin formation	> Product is to arrive in a refrigerated state between 33°F and 41°F	Tuna Salad	Spike Temperature thermometer	Upon receiving of delivery	Inventory manager or inventory assistant	Receiving Record	Review monitoring and corrective actions with inventory controller records weekly  Check accuracy of spike thermometer monthly  Reviewed by supervisor within 24 hours of receipt or prior to the usage of the inventory
	Pathogen growth and toxin formation	> Product temperature to be continuously monitored during shipping in a refrigerated state between 33°F and 40°F	Tuna Salad	> Digital time / temperature data logger	Automatically receive the report from shipper the day following the delivery	Supervisor to receive by email	Shippers Continuous Temperature Data Logger	
Storage	Pathogen growth, scombrotoxin formation (histamine) and toxin formation due to time / temperature abuse	> Refrigerator maintained between 33°F and 40°F	> Refrigerator temperature	> Digital time / temperature data logger	> Continuous monitoring with computer generated notifications to e-mail of deviations with a visual check of the recorded data at least once daily	> Notification recipients of e-mails	> Data logger daily printout with daily visual check sign off  Completion of the "Temperature Deviation Cause and Corrective Action Report" for each incident	> Review log and corrective actions weekly  Manager will complete report and will be verified by supervisor  Check accuracy of continuous monitoring data logger against a standard NIST thermometer once monthly
Distribution to customer including packaging	Pathogen growth, scombrotoxin formation (histamine), toxin formation due to time / temperature abuse and Allergen / Additives	Maintain temperature until delivery at 40°F or less	Temperature upon delivery	Thermometers at customer sites	Upon delivery	Customer site representative	Customer's Daily Delivery Slip	Delivery personnel confirms customer's temperature reading on site
		Packaging to include labeling of any potential inclusion of any of the eleven major food allergens or prohibited additives	Label on container identifying egg, wheat, soy and fish as the allergens	Visually	For every label produced for packaging	By line food packaging staff	Any observed and corrected deviations are recorded on a "Labeling Corrective Action Log" (LCAL)	All containers are reviewed by the shipping staff as they place them into the shipping containers and a weekly review of the LCAL is performed by a supervisor if any occurred

SIGNATURE AND DATE

132

# HACCP PLAN for PAELLA OF SWAIL, SHRIMP AND CRAB

## Control Strategy - Time/Temperature Control

Critical Control Point (CCP)	Significant Hazard (s)	Critical Limits for each Preventive Measure	Monitoring			Corrective Action (s)	Records	Verification
			What	How	Frequency			
Receiving and Storage	Pathogen growth and toxin formation	> Product is to arrive in a completely frozen state of 25°F or less	Frozen Fish & Shellfish	Visually, if in question, with digital or spike temperature thermomete	Upon receiving of delivery	Inventory manager or inventory assistant	Receiving Record	Review monitoring and corrective actions with inventory controller records monthly
		> Freezer maintained at or below 20°F	> Freezer temperature	> Digital time / temperature data logger	> Continuous monitoring with computer generated notifications to e-mail and cell phone of deviations with a visual check of the recorded data at least once daily	> Notification receipts of e-mails and cell calls	> Data logger daily printout with daily visual check sign off	Check the digital or spike thermometer for accuracy and damage and to ensure that it is operational before putting it into operation; perform these same checks daily; and calibrate it once per year or dispose of the thermometer  Review log and corrective actions weekly
Cooking	Pathogen Survival	Oven temperature set to 350° F so as to allow product to reach a minimum internal temperature of 158° F for a minimum of 15 seconds.	Time and temperature of cooking process	Visually with timer or clock and a digital or spike thermometer	Each Batch	Chef	Cooks record	Review cooks record daily by supervisor who initials and dates
		Fish and shellfish to be cooled from 135 degrees F to 70 degrees F in 2 hours and from 70 degrees F to 40 degrees F within 4 more hours	> Cooler temperature	Visually with timer or clock and a digital or spike thermometer	Start with marked containers upon storage and then every 2 hours	Production supervisor or trained staff person	Destroy product and evaluate cooling procedures to create compliant practices	Cooling Chart
Cooling Cooked Product	Pathogenic bacteria growth and toxin formation due to time / temperature abuse	> Cooler maintained at or below 40°F	> Cooler temperature	> Digital time / temperature data logger	> Continuous monitoring with computer generated notifications to e-mail and cell phone of deviations with a visual check of the recorded data at least once daily	> Notification receipts of e-mails and cell calls	> Data logger daily printout with daily visual check sign off	> Review log and corrective actions weekly
						Also contact refer service rep if inadequate temps persist for more than 2 hours	Also contact refer service rep if inadequate temps persist for more than 2 hours	Check accuracy of continuous monitoring data logger against a standard NIST thermometer once monthly

133

Finished Product Storage After Cooling	Pathogenic bacteria growth and toxin formation due to time / temperature abuse	> Cooler maintained at at or below 40°F	> Cooler temperature	> Digital time / temperature data logger	> Continuous monitoring with computer generated notifications to e-mail and cell phone of deviations with a visual check of the recorded data at least once daily	> Notification receipts of e-mails and cell calls	> Move product to a different cooler that is temperature compliant  Also contact refer service rep if inadequate temps persist for more than 2 hours	> Data logger daily printout with daily visual check sign off	> Review log and corrective actions weekly  Check accuracy of continuous monitoring data logger against a standard NIST thermometer once monthly
Preparation for Distribution to customer	Pathogenic bacteria growth and toxin formation due to time / temperature abuse	Reheating of product to reach a minimum internal temperature of 165° F for a minimum of 15 seconds	Time and temperature of re-heating process	Visually with timer or clock and a digital or spike thermometer	A 4% sampling of a batch of containers	Re-heating crew	Continue reheating until critical limit is reached or exceeded and to add 3 minutes incrementally to standard reheating time for each time the fish and shellfish is checked and still under minimum temperature of 165 degrees F	Reheating Foods Log	Heating crew supervisor visually verifies temperatures along side staff personnel when product is exiting oven and staff logs the temperature monitored
Distribution to customer including packaging	Pathogenic bacteria growth, toxin formation due to time / temperature abuse and listing of Allergens / Additives	Maintain temperature until delivery at no less than 140° F	Temperature upon delivery	Thermometers at customer sites	Daily upon delivery	Customer site representative and company delivery person	If temperature is under, customer calls GMC for replacement of product and the incident is logged on a Customer Temperature Deficiency Log and the cause is investigated for needed adjustments to reheating procedures	Customer Temperature Deficiency Log	Delivery personnel confirms temperature deficiency on site with company issued thermometer
		Packaging to include labeling of potential inclusion of any of the eight major food allergens or additives	Label on meal packaging identifying fish & shellfish as the allergen and any other additives or allergens.	Visually	For every bulk food item and individually plated meal that is packaged	By line food packaging staff	Immediately place missing label on meal or food item and investigate the labeling omission for the cause and corrective action needed to prevent future events	All labels applied as well as any corrected deviations are recorded on the "Label Application & Corrective Action Log" (LACAL)	Check the digital or spike thermometer for accuracy and damage and to ensure that it is operational before putting it into operation; perform these same checks daily, and calibrate it once per year or dispose of the thermometer  Supervisor reviews log and corrective actions taken, if any needed, within 1 week and signs and dates the review

SIGNATURE AND DATE

134

**Acknowledgement of US grown food that is utilized in  
the preparation of the menus.**

Tab F-8



# Master Host · Greater Miami Caterers, Inc.



LANDMARKS IN THE FOOD SERVICE INDUSTRY

4001 N.W. 31st AVENUE, MIAMI, FLORIDA 33142

(305) 633-8066 • (305) 633-4616 Broward (954) 927 3266 • Fax (305) 635-5202

Web Site: [www.master-host.net](http://www.master-host.net) • E-mail: [info@mhccater.com](mailto:info@mhccater.com) • Alt. Fax (305) 635-0653

March 25, 2014

William Alonso, City Manager  
City of Miami Springs Senior Center  
343 Payne Drive  
Miami Springs, Fl. 33166

Dear Mr. Alonso,

This document has been generated to acknowledge that the meals provided to the City of Miami Springs Senior Center by Greater Miami Caterers for both congregate and home-bound meal programs contain in excess of the NSIP requirement of American made or grown product content.

Should you have any questions regarding this statement, please feel free to contact me at (305) 633-4616, x.106 or by email at [jolmo@gmccater.com](mailto:jolmo@gmccater.com). Thank you for your consideration.

Sincerely,

John Olmo  
Vice-President

136

**Price Proposal**

Tab G

137



CITY OF MIAMI SPRINGS  
REQUEST FOR PROPOSALS NO. 01-20/21

FORM 12  
PRICE PROPOSAL

THIS PRICE PROPOSAL SHALL BE SUBMITTED IN A SEPARATE, SEALED ENVELOPE THAT WILL BE OPENED AFTER THE TECHNICAL PROPOSAL IS REVIEWED, EVALUATED, AND RANKED

The Contractor agrees to furnish all labor, materials, supplies, supervision, transportation, and services necessary to furnish and deliver meals at the designated times and in the ma

Congregate Meals	Home Delivered Weekday Meals	Home Delivered Weekend Meals
\$ 3.80	\$ 5.06	\$ 4.62

Option Year Costs:

The annual base bid shall be as quoted for the initial one- year contract and shall not increase during any of the five (5) additional one (1) year option terms.

The Proposer shall provide the congregate meals, home delivered weekday meals, and home delivered weekend meals rates for each item as requested below. These prices and rates shall be all inclusive of labor, materials, supplies, supervision, transportation, and services necessary to furnish and deliver meals at the designated times and in the manner called for in these bid specifications.

Bidders must provide a detailed breakdown of each meal (average daily cost of items) in this bid submittal, as follows. (Please keep in mind that the City is exempt from sales tax.)

RAW FOOD, CONDIMENTS, DISPOSABLES, & TRANSPORTATION FEE SCHEDULE: Complete Form 12A.

The undersigned attests to his/her authority to submit this proposal and to bind the firm herein named to perform as per contract, if the firm is awarded the agreement by the City. The undersigned further certifies that he/she has read the Request for Proposal relating to this request and this proposal is submitted with full knowledge and understanding of the requirements and time constraints noted herein.

By signing this form, the proposer hereby declares that this proposal is made without collusion with any other person or entity submitting a proposal pursuant to this RFP.

Firm: Greater Miami Caterers, Inc.

Authorized Signature: 

Title: Vice-President

Print or Type Name: John Olmo

Date: 06/10/21

**CITY OF MIAMI SPRINGS  
REQUEST FOR PROPOSALS NO. 01-20/21**

**FORM 12A  
Unit Fee Schedule**

<b>RAW FOOD COSTS</b>	<b>Congregate Meals</b>	<b>Home Delivered Weekday Meals</b>	<b>Home Delivered Weekend Meals</b>
Entrée (Meat or Alternative)	\$ 0.96	\$ 0.96	\$ 0.96
Vegetable	0.27	0.27	0.27
Fruit	0.25	0.25	0.25
Salad	0.27	0.27	0.27
Grain (Bread or Substitute)	0.14	0.14	0.14
Butter/Margarine	0.01	0.01	0.01
Dessert	0.25	0.25	0.25
Beverage: Milk	0.28	0.28	0.28
Juice (Not on Menu)	—	—	—
<b>TOTAL RAW FOOD COSTS:</b>	<b>2.43</b>	<b>2.43</b>	<b>2.43</b>

<b>CONDIMENT COSTS (Included in raw Food costs)</b>	<b>Congregate Meals</b>	<b>Home Delivered Weekday Meals</b>	<b>Home Delivered Weekend Meals</b>
Ketchup	—	—	—
Mustard	—	—	—
Salt	—	—	—
Salad Dressing	—	—	—
Pepper	—	—	—
<b>TOTAL CONDIMENT COSTS:</b>	<b>—</b>	<b>—</b>	<b>—</b>

CITY OF MIAMI SPRINGS  
REQUEST FOR PROPOSALS NO. 01-20/21

DISPOSABLES COSTS <sup>1</sup>	Congregate Meals	Home Delivered Weekday Meals	Home Delivered Weekend Meals
Paper or Styrofoam Tray	0.095	—	—
Cutlery (In packet Kit)	0.055	0.055	0.055
Napkin(s)	in kit	in kit	in kit
Cup(s)	0.031	0.035	0.035
Bowl(s)	0.02	0.03	0.03
Straw(s)	in kit	in kit	in kit
Aluminum Pan(s)	0.14	—	—
Home Delivery Tray(s) with Lid(s)	—	0.17	0.17
<b>TOTAL DISPOSABLES COSTS:</b>	<b>0.341</b>	<b>0.29</b>	<b>0.29</b>

TRANSPORTATION COSTS	Congregate Meals	Home Delivered Weekday Meals	Home Delivered Weekend Meals
Vehicle Amortization	0.035	0.105	0.053
Maintenance Insurance Depreciation	0.056	0.32	0.16
<b>TOTAL TRANSPORTATION COSTS:</b>	<b>0.091</b>	<b>0.425</b>	<b>0.213</b>

<sup>1</sup> Bidders must provide samples of proposed disposables and packaging with this bid submittal. Paper towels and table coverings to be provided by the City.

CITY OF MIAMI SPRINGS  
REQUEST FOR PROPOSALS NO. 01-20/21

	Congregate Meals	Home Delivered Weekday Meals	Home Delivered Weekend Meals
TOTAL FOOD PREP. COSTS:	0.271	0.632	0.632
TOTAL EQUIPMENT COSTS:	—	—	—

OTHER COSTS (Please provide description for each)	Congregate Meals	Home Delivered Weekday Meals	Home Delivered Weekend Meals
Delivery Personnel	0.197	0.775	0.547
Rent, utilities, Administrative fees, Bank Fees, Computer Technologies, etc	0.356	0.356	0.356
Depreciation, Licenses, Pest Control, Professional Fees, Repairs & Maintenance Security, Kitchen Supplies, Trash Removal and uniforms			

	Congregate Meals	Home Delivered Weekday Meals	Home Delivered Weekend Meals
PROFITS:	0.114	0.152	0.152
TOTALS:	# 3.80	# 5.06	# 4.62

141

**Insurance**

Tab H

142



# CERTIFICATE OF LIABILITY INSURANCE

DATE (MM/DD/YYYY)

6/7/2021

THIS CERTIFICATE IS ISSUED AS A MATTER OF INFORMATION ONLY AND CONFERS NO RIGHTS UPON THE CERTIFICATE HOLDER. THIS CERTIFICATE DOES NOT AFFIRMATIVELY OR NEGATIVELY AMEND, EXTEND OR ALTER THE COVERAGE AFFORDED BY THE POLICIES BELOW. THIS CERTIFICATE OF INSURANCE DOES NOT CONSTITUTE A CONTRACT BETWEEN THE ISSUING INSURER(S), AUTHORIZED REPRESENTATIVE OR PRODUCER, AND THE CERTIFICATE HOLDER.

**IMPORTANT:** If the certificate holder is an ADDITIONAL INSURED, the policy(ies) must be endorsed. If SUBROGATION IS WAIVED, subject to the terms and conditions of the policy, certain policies may require an endorsement. A statement on this certificate does not confer rights to the certificate holder in lieu of such endorsement(s).

<b>PRODUCER</b> Keyes Coverage Insurance 5900 Hiatus Road Tamarac FL 33321	<b>CONTACT NAME:</b> Vanessa Marcano	
	<b>PHONE (A/C, No, Ext):</b> 954-724-7000	<b>FAX (A/C, No):</b>
<b>E-MAIL ADDRESS:</b> vmarcano@keyescor.com		
<b>INSURER(S) AFFORDING COVERAGE</b>		<b>NAIC #</b>
<b>INSURER A :</b> Allied Property & Casualty Ins Co		<b>42579</b>
<b>INSURER B :</b> Nat'l Union Fire of Pittsburgh		<b>19445</b>
<b>INSURER C :</b> Ascendant Commerical Insurance		<b>13683</b>
<b>INSURER D :</b>		
<b>INSURER E :</b>		
<b>INSURER F :</b>		

**COVERAGES**                      **CERTIFICATE NUMBER:** 64608093                      **REVISION NUMBER:**

THIS IS TO CERTIFY THAT THE POLICIES OF INSURANCE LISTED BELOW HAVE BEEN ISSUED TO THE INSURED NAMED ABOVE FOR THE POLICY PERIOD INDICATED. NOTWITHSTANDING ANY REQUIREMENT, TERM OR CONDITION OF ANY CONTRACT OR OTHER DOCUMENT WITH RESPECT TO WHICH THIS CERTIFICATE MAY BE ISSUED OR MAY PERTAIN, THE INSURANCE AFFORDED BY THE POLICIES DESCRIBED HEREIN IS SUBJECT TO ALL THE TERMS, EXCLUSIONS AND CONDITIONS OF SUCH POLICIES. LIMITS SHOWN MAY HAVE BEEN REDUCED BY PAID CLAIMS.

INSR LTR	TYPE OF INSURANCE	ADDL INSD	SUBR WVD	POLICY NUMBER	POLICY EFF (MM/DD/YYYY)	POLICY EXP (MM/DD/YYYY)	LIMITS	
A	<input checked="" type="checkbox"/> <b>COMMERCIAL GENERAL LIABILITY</b> <input type="checkbox"/> CLAIMS-MADE <input checked="" type="checkbox"/> OCCUR  GEN'L AGGREGATE LIMIT APPLIES PER: <input checked="" type="checkbox"/> POLICY <input type="checkbox"/> PRO-JECT <input type="checkbox"/> LOC OTHER:	Y	Y	ACPLGPO3019431511	10/3/2020	10/3/2021	EACH OCCURRENCE	\$ 1,000,000
							DAMAGE TO RENTED PREMISES (Ea occurrence)	\$ 100,000
							MED EXP (Any one person)	\$ 5,000
							PERSONAL & ADV INJURY	\$ 1,000,000
							GENERAL AGGREGATE	\$ 2,000,000
							PRODUCTS - COMP/OP AGG	\$ 2,000,000
								\$
C	<b>AUTOMOBILE LIABILITY</b> <input type="checkbox"/> ANY AUTO ALL OWNED AUTOS <input checked="" type="checkbox"/> HIRED AUTOS <input checked="" type="checkbox"/> SCHEDULED AUTOS NON-OWNED AUTOS OTHER:			CA-53469-0	10/3/2020	10/3/2021	COMBINED SINGLE LIMIT (Ea accident)	\$ 2,000,000
							BODILY INJURY (Per person)	\$
							BODILY INJURY (Per accident)	\$
							PROPERTY DAMAGE (Per accident)	\$
								\$
B	<input checked="" type="checkbox"/> <b>UMBRELLA LIAB</b> <input checked="" type="checkbox"/> OCCUR <input type="checkbox"/> EXCESS LIAB <input type="checkbox"/> CLAIMS-MADE DED    RETENTION \$			EBU015476235	10/3/2020	10/3/2021	EACH OCCURRENCE	\$ 1,000,000
							AGGREGATE	\$
							Over GL Only	\$
	<b>WORKERS COMPENSATION AND EMPLOYERS' LIABILITY</b> ANY PROPRIETOR/PARTNER/EXECUTIVE OFFICER/MEMBER EXCLUDED? (Mandatory in NH) If yes, describe under DESCRIPTION OF OPERATIONS below	Y/N	N/A				PER STATUTE	OTH-ER
							E.L. EACH ACCIDENT	\$
							E.L. DISEASE - EA EMPLOYEE	\$
							E.L. DISEASE - POLICY LIMIT	\$

DESCRIPTION OF OPERATIONS / LOCATIONS / VEHICLES (ACORD 101, Additional Remarks Schedule, may be attached if more space is required)  
 RE: CITY OF MIAMI SPRINGS, REQUEST FOR PROPOSALS NO. 01-20/21  
 Certificate Holder is included as an additional insured with respects to General Liability when required by written contract

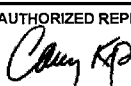
<b>CERTIFICATE HOLDER</b>  City of Miami Springs 201 Westward Drive Miami Springs FL 33166	<b>CANCELLATION 30 Days Notice / 10 Days for Non-Pay</b>  SHOULD ANY OF THE ABOVE DESCRIBED POLICIES BE CANCELLED BEFORE THE EXPIRATION DATE THEREOF, NOTICE WILL BE DELIVERED IN ACCORDANCE WITH THE POLICY PROVISIONS.
	AUTHORIZED REPRESENTATIVE 

© 1988-2014 ACORD CORPORATION. All rights reserved.

143



**Bid Security Bond**

145

Tab 1





CITY OF MIAMI SPRINGS  
REQUEST FOR PROPOSALS NO. 01-20/21

In the presence of :-

  
Witness #1 Print Name: Jose I. Ramirez

Witness #2 Print Name: Domingo FERNANDEZ

Signed, sealed and delivered by:

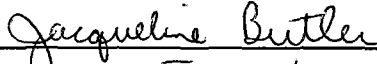
  
Print Name: Jacqueline Butler  
Title: President  
Principal/Firm: GREATER MIAMI CATERERS, INC.

In the presence of:

  
Witness #1 Print Name: Indiana Espinoza

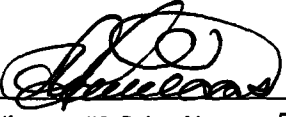
  
Witness #2 Print Name: Deleida Munecas

Westfield Insurance Company

Signed, sealed and delivered by:

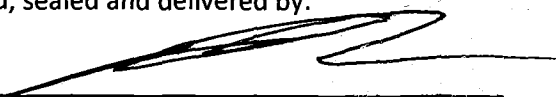
  
Attorney-In-Fact: D.W. MATSON, II  
(Power of Attorney to be attached)

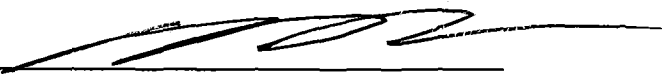
  
Resident Agent D.W. MATSON, III

General Power of Attorney

Westfield Insurance Co. Westfield National Insurance Co. Ohio Farmers Insurance Co. Westfield Center, Ohio

CERTIFIED COPY

Know All Men by These Presents, That WESTFIELD INSURANCE COMPANY, WESTFIELD NATIONAL INSURANCE COMPANY and OHIO FARMERS INSURANCE COMPANY, corporations, hereinafter referred to individually as a "Company" and collectively as "Companies," duly organized and existing under the laws of the State of Ohio, and having its principal office in Westfield Center, Medina County, Ohio, do by these presents make, constitute and appoint D. W. MATSON, III, JOHN W. CHARLTON, JOINTLY OR SEVERALLY

of CORAL GABLES and State of FL its true and lawful Attorney(s)-in-Fact, with full power and authority hereby conferred in its name, place and stead, to execute, acknowledge and deliver any and all bonds, undertakings, and recognizances; provided, however, that the penal sum of any one such instrument executed hereunder shall not exceed TEN MILLION DOLLARS AND NO CENTS (\$10,000,000)---

LIMITATION: THIS POWER OF ATTORNEY CANNOT BE USED TO EXECUTE NOTE GUARANTEE, MORTGAGE DEFICIENCY, MORTGAGE GUARANTEE, OR BANK DEPOSITORY BONDS.

and to bind any of the Companies thereby as fully and to the same extent as if such bonds were signed by the President, sealed with the corporate seal of the applicable Company and duly attested by its Secretary, hereby ratifying and confirming all that the said Attorney(s)-in-Fact may do in the premises. Said appointment is made under and by authority of the following resolution adopted by the Board of Directors of each of the WESTFIELD INSURANCE COMPANY, WESTFIELD NATIONAL INSURANCE COMPANY and OHIO FARMERS INSURANCE COMPANY:

"Be it Resolved, that the President, any Senior Executive, any Secretary or any Fidelity & Surety Operations Executive or other Executive shall be and is hereby vested with full power and authority to appoint any one or more suitable persons as Attorney(s)-in-Fact to represent and act for and on behalf of the Company subject to the following provisions:

The Attorney-in-Fact may be given full power and authority for and in the name of and on behalf of the Company, to execute, acknowledge and deliver, any and all bonds, recognizances, contracts, agreements of indemnity and other conditional or obligatory undertakings and any and all notices and documents canceling or terminating the Company's liability thereunder, and any such Instruments so executed by any such Attorney-in-Fact shall be as binding upon the Company as if signed by the President and sealed and attested by the Corporate Secretary."

"Be it Further Resolved, that the signature of any such designated person and the seal of the Company heretofore or hereafter affixed to any power of attorney or any certificate relating thereto by facsimile, and any power of attorney or certificate bearing facsimile signatures or facsimile seal shall be valid and binding upon the Company with respect to any bond or undertaking to which it is attached." (Each adopted at a meeting held on February 8, 2000).

In Witness Whereof, WESTFIELD INSURANCE COMPANY, WESTFIELD NATIONAL INSURANCE COMPANY and OHIO FARMERS INSURANCE COMPANY have caused these presents to be signed by their National Surety Leader and Senior Executive and their corporate seals to be hereto affixed this 15th day of JANUARY A.D., 2014 .

Corporate Seals Affixed



WESTFIELD INSURANCE COMPANY WESTFIELD NATIONAL INSURANCE COMPANY OHIO FARMERS INSURANCE COMPANY

By: Dennis P. Baus, National Surety Leader and Senior Executive

State of Ohio County of Medina ss.:

On this 15th day of JANUARY A.D., 2014, before me personally came Dennis P. Baus to me known, who, being by me duly sworn, did depose and say, that he resides in Wooster, Ohio; that he is National Surety Leader and Senior Executive of WESTFIELD INSURANCE COMPANY, WESTFIELD NATIONAL INSURANCE COMPANY and OHIO FARMERS INSURANCE COMPANY, the companies described in and which executed the above instrument; that he knows the seals of said Companies; that the seals affixed to said instrument are such corporate seals; that they were so affixed by order of the Boards of Directors of said Companies; and that he signed his name thereto by like order.

Notarial Seal Affixed



William J. Kahelin, Attorney at Law, Notary Public My Commission Does Not Expire (Sec. 147.03 Ohio Revised Code)

State of Ohio County of Medina ss.:

I, Frank A. Carrino, Secretary of WESTFIELD INSURANCE COMPANY, WESTFIELD NATIONAL INSURANCE COMPANY and OHIO FARMERS INSURANCE COMPANY, do hereby certify that the above and foregoing is a true and correct copy of a Power of Attorney, executed by said Companies, which is still in full force and effect; and furthermore, the resolutions of the Boards of Directors, set out in the Power of Attorney are in full force and effect.

In Witness Whereof, I have hereunto set my hand and affixed the seals of said Companies at Westfield Center, Ohio, this 10TH day of JUNE A.D., 2021 .



Frank A. Carrino Secretary

148

# References

CITY OF MIAMI SPRINGS  
REQUEST FOR PROPOSALS NO. 01-20/21

FORM 9  
REFERENCES

IN ADDITION TO THE INFORMATION REQUIRED ON THIS FORM, PLEASE PROVIDE A MINIMUM OF THREE REFERENCE LETTERS, ONE OF WHICH SHOULD BE MUNICIPAL OR GOVERNMENT REFERENCES.

REFERENCE #1

Public Entity Name: Little Havana Activities & Nutrition Centers of Miami Dade County

Reference Contact Person/Title/Department: Betty Ruano-Bond  
Director, Operations & Center-based Services

Contact Number & Email (786) 234-6524  
Betty.Ruano@lhanc.org

Public Entity Size/Number of Residents/Square Mileage: with over 8,000  
residents all Dade County.

Event(s) Completed (include Name of Project/Event, Date of Event Start/Completion, Details on Size/Scope of Work/Complexity) Home Health Care Services, Transportation,  
Home Delivered Meals, Nutrition Counseling, Nutrition  
Risk Assessment Social Services, Primary Health  
Care Physical Fitness, etc.

Is the Contract still Active? Yes  No

CITY OF MIAMI SPRINGS  
REQUEST FOR PROPOSALS NO. 01-20/21

REFERENCE #2

Public Entity Name: City of West Miami

Reference Contact Person/Title/Department: Yolanda Aguilar, City Manager

Contact Number & Email (305) 266-1122

YolandaAguilar@cityofwestmiami.org

Public Entity Size/Number of Residents/Square Mileage: Less than three-quarters of square mile in area and over 6,000 residents.

Event(s) Completed (include Name of Project/Event, Date of Event Start/Completion, Details on

Size/Scope of Work/Complexity) Nutrition Services, Elderly Activities, Transportation, Client Assessments, Social Worker Monitoring, Home Delivered Meals, etc.

Is the Contract still Active? Yes  No

CITY OF MIAMI SPRINGS  
REQUEST FOR PROPOSALS NO. 01-20/21

REFERENCE #3

Public Entity Name: North Miami Foundation

Reference Contact Person/Title/Department: Debbie Kleinberg, Executive Director

Contact Number & Email (305) 893-1450

dk@nmf620.org

Public Entity Size/Number of Residents/Square Mileage: A non-profit social service agency with over 10,000 residents.

Event(s) Completed (include Name of Project/Event, Date of Event Start/Completion, Details on Size/Scope of Work/Complexity) In Home Assessments, Transportation, Home Delivered Meals, Counseling, Caregiver Support, Homemaker and Companion Services, etc.

Is the Contract still Active? Yes  No







Manuel Marrero  
Chairman

Rafael Iglesias  
President and CEO

Mario Luis del Valle  
Vice Chair

Lourdes M. Madariaga  
Treasurer

Luis M. Borges  
Secretary

Alberto Balido  
Director

Elisa De Velasco  
Director

June 8, 2021

City of Miami Springs  
201 Westward Drive  
Miami Springs, FL 33166

RE: Great Miami Caterers, Inc.

Little Havana Activities & Nutrition Centers of Dade County, Inc. ("LHANC") has had the pleasure of working with Great Miami Caterers, Inc. ("GMC") for many years. As our primary meals subcontractor, they have provided our company with an extensive array of meals for all of the services we provide. They serve our child day care, our home-based clients, and the bulk meals offered at the senior centers.

The services that they provide us are competitively bid. As a result of their professionalism, fair pricing, and understanding of the intricacies of the various lines of business that we have, GMC has won the bid process on several occasions. GMC is an integral part of our network and has been instrumental during the COVID-19 pandemic in ensuring that our seniors continued to receive much needed meals without fail.

LHANC is a non-profit organization serving thousands of children and the frail elderly of Miami-Dade County for almost 50 years. LHANC prides itself in providing quality services to its clients through its employees and network of providers.

GMC is an invaluable asset for our company, and I highly recommend that you continue to use them as your preferred meals caterer.

Sincerely,

Betty Ruano-Bond  
Director, Operations and Center-based Services

E-mail: [Betty.Ruano@lhanc.org](mailto:Betty.Ruano@lhanc.org)

Contracted Since: 2014

Current Value: \$3,596,135

Our Partners



United Way  
Member Agency



700 S.W. 8<sup>TH</sup> Street, Miami, Florida 33130-3300  
305-858-0887 - Fax: 305-864-2226

www.Lhanc.org

154

North Miami Foundation  
For Senior Citizens' Services, Inc.

June 6, 2021

To Whom It May Concern:

Since the late 1970's, the North Miami Foundation has contracted with Greater Miami Caterers (GMC) to prepare and deliver home delivered meals to our frail elderly clients.

With our years of experience, I can confidently say that that GMC can be relied upon to provide clients with a nutritious and satisfying meal that is delivered at both the appropriate time and temperature.

I, am therefore, pleased to write this letter of support on their behalf.

Sincerely,

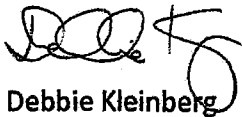

Debbie Kleinberg

Executive Director

E-mail: [dk@nmf620.org](mailto:dk@nmf620.org)  
Contracted Since: 1979  
Current Value: \$423,722



EVELYN PAZ  
Community Center Director

June 8, 2021

To Whom it May Concern,

I am writing to recommend the services of Greater Miami Caterers. We have been using their services for over twenty years. We have purchase meals for the Congregate and Home-Delivered Nutrition Program for the Elderly at our Community Center.

Greater Miami Caterers is a food service management company and has the technical knowledge required to supply such meals. They have been very reasonably priced, and always do exactly what we ask of them.

I am happy to recommend the services of Greater Miami Caterers. If you have any questions, feel free to contact me.

Sincerely,

  
Evelyn Paz

E-mail: [EvelynPaz@cityofwestmiami.org](mailto:EvelynPaz@cityofwestmiami.org)  
Contracted Since: 1997  
Current Value: \$293,616

CITY OF WEST MIAMI

901 S.W. 62nd Avenue • West Miami, FL 33144 • Phone: (305) 263-8900 • Fax: (305) 266-6163  
E-mail: [evelynpaz@cityofwestmiami.org](mailto:evelynpaz@cityofwestmiami.org)

156

# Forms

Tab K

CITY OF MIAMI SPRINGS  
REQUEST FOR PROPOSALS NO. 01-20/21

FORM 1  
PROPOSAL CHECKLIST

- Form 1: Proposal Checklist
- Form 2: Company Qualifications Questionnaire — see Tab D
- Form 3: Certificate of Authority (Complete one of the two forms as applicable)
- Form 3A: Certificate of Authority (for Corporations or Partnerships)
- Form 3B: Certificate of Authority (for Individuals)
- Form 4: Acknowledgment of Addenda
- Form 5: Single Execution Affidavit
- Form 6: Certification for Disclosure of Lobbying Activities on Federal Aid Contracts  
(Compliance with 49 CFR, §20.100(b))
- Form 7: Dispute Disclosure
- Form 8: Key Staff and Proposed Subcontractors — see Tab E1
- Form 9: Reference Letters — see Tab J2
- Form 10: E-Verify Affidavit
- Form 11: IRS Form W-9
- Form 12: Price Proposal — see Tab G
- Form 13: Bid Security/Bid Bond (unless waived) — see Tab I
- Form 14: Performance Bond & Payment Bond (unless waived)

Firm: Greater Miami Caterers, Inc.

Date: 6/10/21

Authorized Signature: 

Print or Type Name: John Olmo

Title: Vice-President

CITY OF MIAMI SPRINGS  
REQUEST FOR PROPOSALS NO. 01-20/21

FORM 3A  
CERTIFICATE OF AUTHORITY  
(if Corporation)

I HEREBY CERTIFY that a meeting of the [circle one] Board of Directors/ Partners of \_\_\_\_\_

Greater Miami Caterers, Inc.

\_\_\_\_\_ a business existing under the laws of the State of Florida (the

"Entity") held on January 20, 2021, the following resolution was duly passed and adopted:

"RESOLVED, that, John Olmo as Vice-President of the Entity, be and is hereby authorized to execute this Proposal dated June 10, 2021, on behalf of the Entity and submit this Proposal to the City of Miami Springs, and this Entity and the execution of this Certificate of Authority, attested to by the Secretary of the Corporation, and with the Entity's Seal affixed, will be the official act and deed of this Entity."

I FURTHER CERTIFY that said resolution is now in full force and effect.

IN WITNESS WHEREOF, I have hereunto set my hand and affixed the official seal of the Entity

this 10<sup>th</sup> day of June, 2021.

Secretary: Jacqueline Butler  
Print Name: Jacqueline Butler

President: Jacqueline Butler  
Print Name: Jacqueline Butler

(Seal)

CITY OF MIAMI SPRINGS  
REQUEST FOR PROPOSALS NO. 01-20/21

FORM 4  
ACKNOWLEDGEMENT OF ADDENDA

I HEREBY ACKNOWLEDGE that I have received all of the following addenda and am informed of the contents thereof:

Addendum Numbers Received:

(Check the box next to each addendum received)

<input checked="" type="checkbox"/> Addendum 1	_____ Addendum 6
<input checked="" type="checkbox"/> Addendum 2	_____ Addendum 7
_____ Addendum 3	_____ Addendum 8
_____ Addendum 4	_____ Addendum 9
_____ Addendum 5	_____ Addendum 10

Firm: Greater Miami Caterers, Inc.

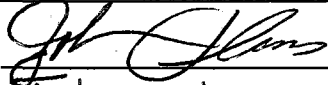
Authorized Signature:  Date: 6/10/21

Print or Type Name: John Olmo Title: Vice-President



Purchasing Department  
201 Westward Drive  
Miami Springs, FL 33166-5259  
Phone: (305) 805-5054  
Fax: (305) 805-5040

Zuzell E. Murguido  
[murguido@miamisprings-fl.gov](mailto:murguido@miamisprings-fl.gov)  
Procurement Specialist II

**AMENDMENT 1**

**CONGREGATE & HOME-DELIVERED MEALS**  
**FOR THE CITY OF MIAMI SPRINGS ELDERLY COMMUNITY**  
REQUEST FOR PROPOSALS (RFP) # 01-20/21  
June 4<sup>th</sup>, 2021

**Request for Proposals # 01-20/21, Congregate & Home-Delivered Meals for  
The City of Miami Springs Elderly Community is amended as follows:**

This addendum is issued to clarify the previously issued request for proposal documents and is hereby made a part of the contract documents. All requirements of the documents not modified herein shall remain in full force and effect as originally set forth.

1. **Question:** On which bid page does it show after we bill monthly for the services when payment will be made by the City of Miami Springs.
1. **Answer:** Page 60 of the RFP, section 3.0 Compensation and Payment of the Professional Service Agreement states "The City shall pay the Contractor in accordance with the Florida Prompt Payment Act after approval and acceptance of the Services by the City Manager". The City processes check runs twice a month.
  
2. **Question:** Is there any addendum for this bid?
2. **Answer:** This is the first Amendment issued with relation to this RFP.
  
3. **Question:** What is the current price for each of the food line items?
3. **Answer:** Attached is a copy of the prices broken down by food item submitted in the last RFP response in 2015, which is the most recent breakdown we have.
  
4. **Question:** Who is the current supplier?
4. **Answer:** Greater Miami Caterers.
  
5. **Question:** When will the successful bidder need to start the contract?
5. **Answer:** 10/1/2021.
  
6. **Question:** I understand you are looking for 100% performance bond for the successful bidder, do you take the current pandemic of covid19 into account?
6. **Answer:** In the event of another outbreak due to the Covid19 pandemic, services will be altered in writing, accordingly.



7. **Question:** In order to develop a menu that pleases every one, can you please tell me the percentage of the ethnics group you are currently serving?
7. **Answer:** There is approximately 70% Hispanic and 30% Anglo.
8. **Question:** Do you have a Nutritionist for the program and if yes, can you please share the contact info?
8. **Answer:** Yes, we have a Licensed Registered Dietitian and her contact information will be provided to the awarded contractor.
9. **Question:** Can you please send me another set of the bid package?
9. **Answer:** The bid package can be found on our website <https://www.miamisprings-fl.gov/profservices/rfp-01-2021-congregate-home-delivered-meals-city-miami-springs-elderly-community> and on DemandStar <https://www.demandstar.com/>.

**REQUEST FOR PROPOSAL (RFP) and CONTRACT for  
CATERING SERVICES for the CITY OF MIAMI SPRINGS SENIOR CENTER'S  
NUTRITION PROGRAMS FOR THE ELDERLY**

ISSUED BY: **THE CITY OF MIAMI SPRINGS**

NAME: Tammy Romero, Professional Services Supervisor

ADDRESS: Miami Springs City Hall, 201 Westward Drive, Miami Springs, FL 33166

BID NUMBER: RFP# 04-14/15

BID ISSUE DATE: June 19th, 2015      BID OPENING: Tuesday, July 21st, 2015

LOCATION: Council Chambers, 2nd floor      TIME: 2:30 p.m.

CONTRACT COMMENCEMENT DATE: October 1, 2015

CONTRACT EXPIRATION DATE: September 30, 2016

PER MEAL: FOR PAYMENT WITHIN 45 DAYS OF RECEIPT OF INVOICE

CONGREGATE MEALS (Title III C-1): \$ 3.18

HOME DELIVERED WEEKDAY MEALS (Title III C-2): \$ 4.10

HOME DELIVERED WEEKEND MEALS (Non-DOEA): \$ 3.76

NAME OF BIDDER: Greater Miami Caterers, Inc.

  
(Authorized Representative of Bidder)

STREET ADDRESS: 4001 NW 31st Avenue

John Olmo  
Type or Print Name of Representative

CITY, STATE, ZIP CODE: Miami, FL 33142

Vice-President  
Title of Representative

TELEPHONE: (305) 633-4616

This document contains a Request for Proposal (RFP) for the purchasing of meals to be served to the participants of the City of Miami Springs' Nutrition Programs for the Elderly and sets forth the terms and conditions applicable to the proposed procurement. Upon acceptance, this document shall constitute the contract between the Bidder and the City of Miami Springs.

**ACCEPTANCE**

BY: \_\_\_\_\_

WITNESS: \_\_\_\_\_

TITLE: \_\_\_\_\_

DATE: \_\_\_\_\_

163

## BID PROPOSAL

The Contractor agrees to furnish all labor, materials, supplies, supervision, transportation, and services necessary to furnish and deliver meals at the designated times and in the manner called for in these bid specifications for the following price:

- |    |                              |                |
|----|------------------------------|----------------|
| 1. | Congregate Meals             | \$ <u>3.18</u> |
| 2. | Home Delivered Weekday Meals | \$ <u>4.10</u> |
| 3. | Home Delivered Weekend Meals | \$ <u>3.76</u> |

Bidders must provide a detailed breakdown of each meal (average daily cost of items) in this bid submittal, as follows. (Please keep in mind that Grantee is exempt from sales tax.)

	<u>Congregate Meals</u>	<u>Home Delivered Weekday Meals</u>	<u>Home Delivered Weekend Meals</u>
<b><u>Raw Food Costs:</u></b>			
Entrée: Meat or Alternative	\$ <u>0.87</u>	\$ <u>0.87</u>	\$ <u>0.87</u>
Vegetable	\$ <u>0.23</u>	\$ <u>0.23</u>	\$ <u>0.23</u>
Fruit	\$ <u>0.22</u>	\$ <u>0.22</u>	\$ <u>0.22</u>
Salad	\$ <u>0.23</u>	\$ <u>0.23</u>	\$ <u>0.23</u>
Grain: Bread or Substitute	\$ <u>0.121</u>	\$ <u>0.121</u>	\$ <u>0.121</u>
Butter/Margarine	\$ <u>0.006</u>	\$ <u>0.006</u>	\$ <u>0.006</u>
Dessert	\$ <u>0.235</u>	\$ <u>0.235</u>	\$ <u>0.235</u>
Beverage: Milk	\$ <u>0.26</u>	\$ <u>0.26</u>	\$ <u>0.26</u>
Juice - Not On Menu	\$ <u>---</u>	\$ <u>---</u>	\$ <u>---</u>
<b>TOTAL RAW FOOD COSTS:</b>	<b>\$ <u>2.172</u></b>	<b>\$ <u>2.172</u></b>	<b>\$ <u>2.172</u></b>
<b><u>Condiments: - Included in Raw foods Cost</u></b>			
Ketchup	\$ <u>---</u>	\$ <u>---</u>	\$ <u>---</u>
Mustard	\$ <u>---</u>	\$ <u>---</u>	\$ <u>---</u>
Salt	\$ <u>---</u>	\$ <u>---</u>	\$ <u>---</u>
Salad Dressing	\$ <u>---</u>	\$ <u>---</u>	\$ <u>---</u>
Pepper	\$ <u>---</u>	\$ <u>---</u>	\$ <u>---</u>
<b>TOTAL CONDIMENT COSTS:</b>	<b>\$ <u>---</u></b>	<b>\$ <u>---</u></b>	<b>\$ <u>---</u></b>

164

(NOTE: Bidders must provide samples of proposed disposables and packaging with this bid submittal.)

Disposables:

Paper or Styrofoam Tray	\$ <u>0.034</u>	\$ <u>----</u>	\$ <u>----</u>
Cutlery - In Packet Kit	\$ <u>0.044</u>	\$ <u>----</u>	\$ <u>----</u>
Napkin - In Packet Cost	\$ <u>----</u>	\$ <u>----</u>	\$ <u>----</u>
Cup (s)	\$ <u>0.017</u>	\$ <u>----</u>	\$ <u>----</u>
Bowls (s)	\$ <u>0.012</u>	\$ <u>----</u>	\$ <u>----</u>
Straw (s)	\$ <u>in kit</u>	\$ <u>----</u>	\$ <u>----</u>
Aluminum Pans	\$ <u>0.025</u>	\$ <u>----</u>	\$ <u>----</u>
Home Del. Trays w/Lids	\$ <u>----</u>	\$ <u>0.244</u>	\$ <u>0.244</u>
<b>TOTAL SUPPLY COSTS:</b>	\$ <u>0.132</u>	\$ <u>0.244</u>	\$ <u>0.244</u>

Note: Paper towels and table coverings to be provided by the Grantee

Transportation:

Vehicle Amortization	\$ <u>0.062</u>	\$ <u>0.086</u>	\$ <u>0.079</u>
Maint., Ins., Depreciation & Delivery Personnel	\$ <u>0.125</u>	\$ <u>0.90</u>	\$ <u>0.695</u>
<b>TOTAL TRANS. COSTS:</b>	\$ <u>0.187</u>	\$ <u>0.986</u>	\$ <u>0.774</u>
<b>TOTAL FOOD PREP. COSTS:</b>	\$ <u>0.241</u>	\$ <u>0.447</u>	\$ <u>0.34</u>
<b>TOTAL EQUIP. COSTS:</b>	\$ <u>----</u>	\$ <u>----</u>	\$ <u>----</u>
<u>Other:</u>			
Mortgage, Rent, Utilities, Administrative, Bank Fees, computer Technologies, Depreciation, Licenses, Pest Control, Professional Fees, Repair & Maintenance, Security, Kitchen Supplies, Trash Removal & Uniforms.	\$ <u>0.353</u>	\$ <u>0.128</u>	\$ <u>0.117</u>
	\$ <u>----</u>	\$ <u>----</u>	\$ <u>----</u>
	\$ <u>----</u>	\$ <u>----</u>	\$ <u>----</u>
	\$ <u>----</u>	\$ <u>----</u>	\$ <u>----</u>
<b>PROFITS:</b>	\$ <u>0.095</u>	\$ <u>0.123</u>	\$ <u>0.113</u>
<b>TOTALS:</b>	\$ <u>3.18</u>	\$ <u>4.10</u>	\$ <u>3.76</u>

165

CITY OF MIAMI SPRINGS



Purchasing Department  
201 Westward Drive  
Miami Springs, FL 33166-5259  
Phone: (305) 805-5054  
Fax: (305) 805-5040

Zuzell E. Murguido  
[murguido@miamisprings-fl.gov](mailto:murguido@miamisprings-fl.gov)  
Procurement Specialist II

**AMENDMENT 2**

**CONGREGATE & HOME-DELIVERED MEALS**  
**FOR THE CITY OF MIAMI SPRINGS ELDERLY COMMUNITY**  
REQUEST FOR PROPOSALS (RFP) # 01-20/21  
June 4<sup>th</sup>, 2021

**Request for Proposals # 01-20/21, Congregate & Home-Delivered Meals for  
The City of Miami Springs Elderly Community is amended as follows:**

This addendum is issued to clarify the previously issued request for proposal documents and is hereby made a part of the contract documents. All requirements of the documents not modified herein shall remain in full force and effect as originally set forth.

1. **Question:** In regards to solicitation No. 01-20/21 congregate & home-delivered meals, tab I/Form 13 requires a 5% Bond or Cashier's Check to accompany the bid. Is this correct or will the Bond requirement be waived?
1. **Answer:** This is correct. A 5% bid bond is required.

CITY OF MIAMI SPRINGS  
REQUEST FOR PROPOSALS NO. 01-20/21

**FORM 5**  
**SINGLE EXECUTION AFFIDAVITS**

THIS FORM COMBINES SEVERAL AFFIDAVIT STATEMENTS TO BE SWORN TO BY THE RESPONDENT OR BIDDER AND NOTARIZED BELOW. IN THE EVENT THE RESPONDENT OR BIDDER CANNOT SWEAR TO ANY OF THESE AFFIDAVIT STATEMENTS, THE RESPONDENT OR BIDDER IS DEEMED TO BE NON-RESPONSIBLE AND IS NOT ELIGIBLE TO SUBMIT A PROPOSAL/BID.

THESE SINGLE EXECUTION AFFIDAVITS ARE STATEMENTS MADE ON BEHALF OF:

Greater Miami Caterers, Inc.

NAME OF PROPOSING OR BIDDING ENTITY

By: John Olmo, Vice-President

INDIVIDUAL'S NAME AND TITLE

59-1209174

FEIN OF PROPOSING OR BIDDING ENTITY

Date: 6/10/21

**Americans with Disabilities Act Compliance Affidavit**

The above named firm, corporation or organization is in compliance with and agrees to continue to comply with, and assure that any subcontractor, or third party contractor under this project complies with all applicable requirements of the laws listed below including, but not limited to, those provisions pertaining to employment, provision of programs and services, transportation, communications, access to facilities, renovations, and new construction.

- The American with Disabilities Act of 1990 (ADA), Pub. L. 101-336, 104 Stat 327, 42 USC 1210112213 and 47 USC Sections 225 and 661 including Title I, Employment; Title II, Public Services; Title III, Public Accommodations and Services Operated by Private entities; Title IV, Telecommunications; and Title V, Miscellaneous Provisions.
- The Florida Americans with Disabilities Accessibility Implementation Act of 1993, Section 553.501-553.513, Florida Statutes:
- The Rehabilitation Act of 1973, 229 USC Section 794;
- The Federal Transit Act, as amended 49 USC Section 1612;
- The Fair Housing Act as amended 42 USC Section 3601-3631.

GO

Respondent Initials

**Public Entity Crimes Affidavit**

I understand that a "public entity crime" as defined in Paragraph 287.133(1)(g), Florida Statutes, means a violation of any state or federal law by a person with respect to and directly related to the transaction of business with any public entity or with an agency or political subdivision of any other state or of the United States, including but not limited to, any bid or contract for goods or services to be provided to any public entity or an agency or political subdivision of any other state or of the United States and involving antitrust, fraud, theft, bribery, collusion, racketeering, conspiracy, or material misrepresentations.

I understand that "convicted" or "conviction" as defined in Paragraph 287.133(1)(b), Florida Statutes, means a finding of guilt or a conviction of a public entity crime, with or without an adjudication of guilt,

**CITY OF MIAMI SPRINGS  
REQUEST FOR PROPOSALS NO. 01-20/21**

in any federal or state trial court of record relating to charges brought by indictment or information after July 1, 1989, as a result of a jury verdict, non-jury trial, or entry of a plea of guilty or nolo contendere.

I understand that an "affiliate" as defined in Paragraph 287.133(1)(a), Florida Statutes, means:

1. A predecessor or successor of a person convicted of a public entity crime; or
2. An entity under the control of any natural person who is active in the management of the entity and who has been convicted of a public entity crime. The term "affiliate" includes those officers, directors, executives, partners, shareholders, employees, members, and agents who are active in the management of an affiliate. The ownership by one person of shares constituting a controlling interest in another person, or a pooling of equipment or income among persons when not for fair market value under an arm's length agreement, shall be a prima facie case that one person controls another person. A person who knowingly enters into a joint venture with a person who has been convicted of a public entity crime in Florida during the preceding 36 months shall be considered an affiliate.

I understand that a "person" as defined in Paragraph 287.133(1)(e), Florida Statutes, means any natural person or entity organized under the laws of any state or of the United States with the legal power to enter into a binding contract and which bids or applies to bid on contracts for the provision of goods or services let by a public entity, or which otherwise transacts or applies to transact business with a public entity. The term "person" includes those officers, directors, executives, and partners, shareholders, employees, members, and agents who are active in management of an entity.

Based on information and belief, the statement, which I have marked below, is true in relations to the entity submitting this sworn statement.

**(INDICATE WHICH STATEMENT APPLIES.)**

Neither the entity submitting this sworn statement, nor any of its officers, directors, executives, partners, shareholders, employees, members, or agents who are active in the management of the entity, nor any affiliate of the entity has been charged with and convicted of a public entity crime subsequent to July 1, 1989.

The entity submitting this sworn statement, or one or more of its officers, directors, executives, partners, shareholders, employees, members, or agents who are active in the management of the entity, or an affiliate of the entity has been charged with and convicted of a public entity crime subsequent to July 1, 1989.

The entity submitting this sworn statement, or one or more of its officers, directors, executives, partners, shareholders, employees, members, or agents who are active in the management of the entity, or an affiliate of the entity has been charged with and convicted of a public entity crime subsequent to July 1, 1989. However, there has been a subsequent proceeding before a Hearing Officer of the State of Florida, Division of Administrative Hearings and the final Order entered by the Hearing Officer determined that it was not in the public interest to place the entity submitting this sworn statement on the convicted Contractor list (attach a copy of the final order).

I understand that the submission of this form to the contracting officer for the public entity identified in paragraph 1 above is for that public entity only and that this form is valid through December 31 of the

**CITY OF MIAMI SPRINGS  
REQUEST FOR PROPOSALS NO. 01-20/21**

calendar year in which it is filed. I also understand that I am required to inform the public entity prior to entering into a contract in excess of the threshold amount provided in Section 287.017, Florida Statutes for category two of any change in the information contained in this form.

JO  
Respondent Initials

**No Conflict of Interest or Contingent Fee/Anti-Kickback/Code of Ethics Affidavit**

Respondent warrants that neither it nor any principal, employee, agent, representative nor family member has paid, promised to pay, or will pay any fee or consideration that is contingent on the award or execution of a contract arising out of this solicitation. Respondent also warrants that neither it nor any principal, employee, agent, representative nor family member has procured or attempted to procure this contract in violation of any of the provisions of the Miami-Dade County conflict of interest or code of ethics ordinances. Further, Respondent acknowledges that any violation of this warranty will result in the termination of the contract and forfeiture of funds paid or to be paid to the Respondent should the Respondent be selected for the performance of this contract.

JO  
Respondent Initials

**Business Entity Affidavit**

Respondent hereby recognizes and certifies that no elected official, board member, or employee of the City of Miami Springs (the "City") shall have a financial interest directly or indirectly in this transaction or any compensation to be paid under or through this transaction, and further, that no City employee, nor any elected or appointed officer (including City board members) of the City, nor any spouse, parent or child of such employee or elected or appointed officer of the City, may be a partner, officer, director or proprietor of Respondent or Contractor, and further, that no such City employee or elected or appointed officer, or the spouse, parent or child of any of them, alone or in combination, may have a material interest in the Contractor or Respondent. Material interest means direct or indirect ownership of more than 5% of the total assets or capital stock of the Respondent. Any exception to these above described restrictions must be expressly provided by applicable law or ordinance and be confirmed in writing by City. Further, Respondent recognizes that with respect to this transaction or bid, if any Respondent violates or is a party to a violation of the ethics ordinances or rules of the City, the provisions of Miami-Dade County Code Section 2-11.1, as applicable to City, or the provisions of Chapter 112, part III, Fla. Stat., the Code of Ethics for Public Officers and Employees, such Respondent may be disqualified from furnishing the goods or services for which the bid or proposal is submitted and may be further disqualified from submitting any future bids or proposals for goods or services to City.

JO  
Respondent Initials



**CITY OF MIAMI SPRINGS  
REQUEST FOR PROPOSALS NO. 01-20/21**

**Non-Collusion/Anti-Collusion Affidavit**

1. Respondent/Bidder has personal knowledge of the matters set forth in its Proposal/Bid and is fully informed respecting the preparation and contents of the attached Proposal/Bid and all pertinent circumstances respecting the Proposal/Bid;
2. The Proposal/Bid is genuine and is not a collusive or sham Proposal/Bid; and
3. Neither the Respondent/Bidder nor any of its officers, partners, owners, agents, representatives, employees, or parties in interest, including Affiant, has in any way colluded, conspired, connived, or agreed, directly or indirectly with any other Respondent/Bidder, firm, or person to submit a collusive or sham Proposal/Bid, or has in any manner, directly or indirectly, sought by agreement or collusion or communication or conference with any other Respondent/Bidder, firm, or person to fix the price or prices in the attached Proposal/Bid or of any other Respondent/Bidder, or to fix any overhead, profit, or cost element of the Proposal/Bid price or the Proposal/Bid price of any other Respondent/Bidder, or to secure through any collusion, conspiracy, connivance or unlawful agreement any advantage against City of Miami Springs or any person interested in the proposed Contract.

  
Respondent Initials

**Scrutinized Companies**

1. Respondent certifies that it and its subcontractors are not on the Scrutinized Companies that Boycott Israel List. Pursuant to Section 287.135, F.S., the City may immediately terminate the Agreement that may result from this RFP at its sole option if the Respondent or its subcontractors are found to have submitted a false certification; or if the Respondent, or its subcontractors are placed on the Scrutinized Companies that Boycott Israel List or is engaged in the boycott of Israel during the term of the Agreement.
2. If the Agreement that may result from this RFP is for more than one million dollars, the Respondent certifies that it and its subcontractors are also not on the Scrutinized Companies with Activities in Sudan, Scrutinized Companies with Activities in the Iran Petroleum Energy Sector List, or engaged with business operations in Cuba or Syria as identified in Section 287.135, F.S. pursuant to Section 287.135, F.S., the City may immediately terminate the Agreement that may result from this RFP at its sole option if the Respondent, its affiliates, or its subcontractors are found to have submitted a false certification; or if the Respondent, its affiliates, or its subcontractors are placed on the Scrutinized Companies with Activities in Sudan List, or Scrutinized Companies with Activities in the Iran Petroleum Energy Sector List, or engaged with business operations in Cuba or Syria during the term of the Agreement.
3. The Respondent agrees to observe the above requirements for applicable subcontracts entered into for the performance of work under the Agreement that may result from this RFP. As provided in Subsection 287.135(8), F.S., if federal law ceases to authorize the above-stated contracting prohibitions then they shall become inoperative.

  
Respondent Initials

**CITY OF MIAMI SPRINGS  
REQUEST FOR PROPOSALS NO. 01-20/21**

**Acknowledgment, Warranty, and Acceptance**

1. Contractor warrants that it is willing, able to, and will comply with all applicable federal, state, county, and local laws, rules and regulations.
2. Contractor warrants that it has read, understands, and is willing to and will comply with all of the requirements of the solicitation and any and all addenda issued pursuant thereto.
3. Contractor warrants that it will not delegate or subcontract its responsibilities under an agreement without the prior written permission of the City Manager.
4. Contractor warrants that all information provided by it in connection with this proposal is true and accurate.
5. I hereby propose to furnish the services specified in the RFP. I agree that my Proposal will remain firm for a period of 365 days in order to allow the City adequate time to evaluate the Statements of Qualifications.
6. I certify that all information contained in this Proposal is truthful to the best of my knowledge and belief. I further certify that I am duly authorized to submit this Statement of Qualification on behalf of the firm as its act and deed and that the firm is ready, willing and able to perform if awarded the contract.
7. I understand that a person or affiliate who has been placed on the convicted Contractor list following a conviction for public entity crimes may not submit a bid on a contract to provide any goods or services to a public entity, may not submit a bid on a contract with a public entity for the construction or repair of a public building or public work, may not submit bids on leases of real property to public entity, may not be awarded or perform work as a contractor, supplier, sub-contractor, or Contractor under a contract with a public entity, and may not transact business with any public entity in excess of the threshold amount provided in Sec. 287.017, for CATEGORY TWO for a period of 36 months from the date of being placed on the convicted Contractor list.

  
Respondent Initials

**Ownership Disclosure Affidavit**

1. If the contract or business transaction is with a corporation or company, the full legal name and business address shall be provided for each officer, director, member and manager and each stockholder or member who holds directly or indirectly five percent (5%) or more of the corporation's or company's stock or shares. If the contract or business transaction is with a trust, the full legal name and address shall be provided for each trustee and each beneficiary. All such names and addresses are (Post Office addresses are not acceptable), as follows (attach additional sheet, if necessary):

Name	Address	Ownership (%)
Jacqueline Butler	1461 NE 102 Street Miami, FL 33138	56%

**CITY OF MIAMI SPRINGS  
REQUEST FOR PROPOSALS NO. 01-20/21**

John Olmo	318 S.W. 163 Ave. Pembroke Pines, FL 33027	24%
John Butler	10007 N.E. 4 <sup>th</sup> Ave. Miami, FL 33138	20%

2. The full legal names and business address of any other individual (other than subcontractors, material men, suppliers, laborers, or lenders) who have, or will have, any interest (legal, equitable, beneficial or otherwise) in the contract or business transaction with the City are (Post Office addresses are not acceptable), as follows (attach additional sheet, if necessary):

Name	Address
N/A	

go  
Respondent Initials

**Truth in Negotiation Certificate**

The Contractor hereby certifies, covenants, and warrants that wage rates and other factual unit costs supporting the compensation for projects and services that may be offered pursuant to this Request for Proposals and the Continuing Services Agreement related thereto will be accurate, complete, and current at the time of contracting. The Contractor further agrees that the price provided under separate, project specific agreements and any additions thereto shall be adjusted to exclude any significant sums by which the City determines the agreement price was increased due to inaccurate, incomplete, or non-current wage rates and other factual unit costs. All such agreement adjustments shall be made within one (1) year

**CITY OF MIAMI SPRINGS  
REQUEST FOR PROPOSALS NO. 01-20/21**

following the end of each corresponding agreement. For purpose of this certificate, the end of the agreement shall be deemed to be the date of the final billing or acceptance of the work by the City, whichever is later. The undersigned firm is furnishing this Truth in Negotiation Certificate pursuant to Section 287.055(5)(a), Florida Statutes for the undersigned firm to receive a continuing agreement for professional architecture and engineering services with the City of Miami Springs, Florida.

go  
Respondent Initials

**Prohibition on Contingent Fees**

The Contractor warrants that he or she has not employed or retained any company or person, other than a bona fide employee working solely for the Contractor to solicit or secure this Request for Proposals and the Continuing Services Agreement related thereto and that he or she has not paid or agreed to pay any person, company, corporation, individual, or firm, other than a bona fide employee working solely for the Contractor any fee, commission, percentage, gift, or other consideration contingent upon or resulting from the award or making of this agreement. The undersigned Contractor is furnishing this statement pursuant to Section 287.055(6)(a), Florida Statutes for the undersigned firm to receive a continuing agreement for professional architecture and engineering services with the City of Miami Springs, Florida. Contractor understands that for the breach or violation of this provision, the City shall have the right to terminate the resulting agreement without liability and, at its discretion, to deduct from the contract price, or otherwise recover, the full amount of such fee, commission, percentage, gift, or consideration. The provisions of this statement shall be incorporated in the resulting agreement, if awarded, as though fully stated therein.

go  
Respondent Initials

**Sworn Signature of Proposing Entity Representative and Notarization  
for all above Affidavits follows on the next page.**

CITY OF MIAMI SPRINGS  
REQUEST FOR PROPOSALS NO. 01-20/21

In the presence of:

Witness #1 Print Name: Jose Ramirez

Witness #2 Print Name: Patricia Diaz

Signed, sealed and delivered by:

Print Name: John Olmo

Title: Vice-President

Firm: Greater Miami Caterers, Inc.

**ACKNOWLEDGMENT**

State of Florida  
County of Miami-Dade

The foregoing instrument was acknowledged before me by means of  physical presence or  online notarization, this 10 day of June, 2021, by JOHN OLMO (name of person) as VICE-PRESIDENT (type of authority) for GREATER MIAMI CATERERS (name of party on behalf of whom instrument is executed).

Luis Porras  
Notary Public (Print, Stamp, or Type as Commissioned)

- Personally known to me; or
- Produced identification (Type of Identification: \_\_\_\_\_)
- Did take an oath; or
- Did not take an oath

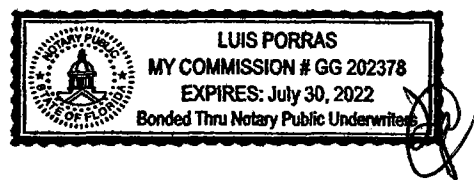

CITY OF MIAMI SPRINGS  
REQUEST FOR PROPOSALS NO. 01-20/21

FORM 6

**CERTIFICATION FOR DISCLOSURE OF LOBBYING ACTIVITIES ON FEDERAL-AID CONTRACTS**  
**(Compliance with 49 CFR, Section 20.100 (b))**

The prospective participant certifies, by signing this certification, that to the best of his or her knowledge and belief:

1. No federal appropriated funds have been paid or will be paid, by or on behalf of the undersigned, to any person for influencing or attempting to influence an officer or employee of any federal agency, a Member of Congress, an officer or employee of Congress, or an employee of a Member of Congress in connection with the awarding of any federal contract, the making of any federal grant, the making of any federal loan, the entering into of any cooperative agreement, and the extension, continuation, renewal, amendment, or modification of any federal contract, grant, loan, or cooperative agreement.
2. If any funds other than federal appropriated funds have been paid or will be paid to any person for influencing or attempting to influence an officer or employee of any federal agency, a Member of Congress, an officer or employee of Congress, or an employee of a Member of Congress in connection with this federal contract, grant, loan, or cooperative agreement, the undersigned shall complete and submit Standard Form-LLL, "Disclosure of Lobbying Activities", in accordance with its instructions. (Standard Form-LLL can be obtained from the Florida Department of Transportation's Professional Services Administrator or Procurement Office.)
3. The undersigned shall require that the language of this certification be included in the award documents for all subawards at all tiers (including subcontracts, subgrants, and contracts under grants, loans, and cooperative agreements) and that all subrecipients shall certify and disclose accordingly.
4. This certification is a material representation of fact upon which reliance was placed when this transaction was made or entered into. Submission of this certification is a prerequisite for making or entering into this transaction imposed by Section 1352, Title 31, U.S. Code (as amended by the Lobbying Disclosure Act of 1995). Any person who fails to file the required certification shall be subject to a civil penalty of not less than \$10,000 and not more than \$100,000 for each such failure.
5. The Contractor described below certifies or affirms the truthfulness and accuracy of each statement of its certification and disclosure, if any. In addition, the Contractor understands and agrees that the provisions of 31 U.S.C. § 3801 *et seq.*, apply to this certification and disclosure, if any.

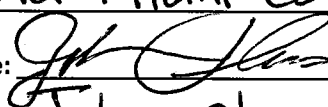
Firm: Greater Miami Caterers, Inc.  
Authorized Signature:  Date: 6/10/21  
Print or Type Name: John Olmo Title: Vice-President

CITY OF MIAMI SPRINGS  
REQUEST FOR PROPOSALS NO. 01-20/21

FORM 7  
DISPUTE DISCLOSURE

Answer the following questions by placing an "X" before the "Yes" or "No". If you answer "Yes" to any of the questions, please explain in the space provided, or on a separate sheet attached to this form.

1. Has your firm or any of its officers, received a reprimand of any nature or been suspended by the Department of Professional Regulations or any other regulatory agency or professional associations within the last five (5) years?

No  Yes

2. Has your firm, or any member of your firm, been declared in default, terminated or removed from a contract or job related to the services your firm provides in the regular course of business within the last five (5) years?

No  Yes

3. Has your firm had against it or filed any requests for equitable adjustment, contract claims, Bid protests, or litigation in the past five (5) years that is related to the services your firm provides in the regular course of business?

No  Yes

If yes, state the nature of the request for equitable adjustment, contract claim, protest, litigation, and/or regulatory action, and state a brief description of the case, the outcome or status of the suit, the monetary amounts of extended contract time involved, and the court or agency before which the action was instituted, the applicable case or file number, and the status or disposition for such reported action. Describe all litigation (include the court and location) of any kind involving Contractor or any Key Staff members within the last five (5) years.

I hereby certify that all statements made are true and agree and understand that any misstatement or misrepresentation or falsification of facts shall be cause for forfeiture of rights for further consideration of this Proposal for the City of Miami Springs.

Firm: Greater Miami Caterers, Inc.

Authorized Signature: 

Date: 6/10/21

Print or Type Name: John Olmo

Title: Vice-president

CITY OF MIAMI SPRINGS  
REQUEST FOR PROPOSALS NO. 01-20/21

FORM 10  
E-VERIFY AFFIDAVIT

In accordance with Section 448.095, Florida Statutes, the City of Miami Springs requires all contractors doing business with the City to register with and use the E-Verify system to verify the work authorization status of all newly hired employees. The City will not enter into a contract unless each party to the contract registers with and uses the E-Verify system.

The respondent Firm must provide of its proof of enrollment in E-Verify. For instructions on how to provide proof of the Firm's participation/enrollment in E-Verify, please visit: <https://www.e-verify.gov/faq/how-do-i-provide-proof-of-my-participation-enrollment-in-e-verify>

By submitting a response to this RFP and signing below, the respondent Firm acknowledges that it has read Section 448.095, Florida Statutes and will comply with the E-Verify requirements imposed by it, including but not limited to obtaining E-Verify affidavits from subcontractors.

Check here to confirm proof of enrollment in E-Verify has been submitted as part of the response.

In the presence of:

Witness #1 Print Name: Jose Ramirez

Witness #2 Print Name: Patricie Diaz

Signed, sealed and delivered by:

Print Name: John Olmo

Title: Vice-President

Firm: Greater Miami Caterers, Inc.

ACKNOWLEDGMENT

State of Florida  
County of Miami-Dade

The foregoing instrument was acknowledged before me by means of  physical presence or  online notarization, this 10 day of June, 2021, by John Olmo  
(name of person) as VICE-PRESIDENT (type of authority) for GREATER MIAMI CATERERS

(name of party on behalf of whom instrument is executed).

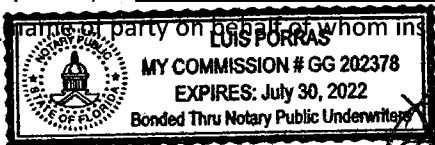

Luis Porras  
Notary Public (Print, Stamp, or Type as Commissioned)

- Personally known to me; or
- Produced identification (Type of Identification: \_\_\_\_\_)
- Did take an oath; or
- Did not take an oath

177





Welcome  
JOHN BUTLER

≡ MENU

## Company Information

**Company Name**  
GREATER MAMI CATERERS, INC

**Company ID Number**  
361726

**Doing Business As (DBA) Name**  
MASTER HOST

**DUNS Number**  
--

### Physical Location

**Address 1**  
4001 NW 31ST AVE.

**Address 2**  
--

**City**  
MIAMI

**State**  
FL

**Zip Code**  
33142

**County**  
MIAMI-DADE

### Mailing Address

**Address 1**  
--

**Address 2**  
--

**City**  
--

**State**  
--

**Zip Code**

178

--

**Additional Information**

**Employer Identification Number**

591209174

**Total Number of Employees**

100 to 499

**Parent Organization**

GREATER MIAMI CATERERS, INC

**Administrator**

--

**Organization Designation**

**Employer Category**

None of these categories apply

[View / Edit](#)

**NAICS Code**

722 - FOOD SERVICES AND DRINKING PLACES

[View / Edit](#)

**Total Hiring Sites**

1

[View / Edit](#)

**Total Points of Contact**

3

[View / Edit](#)

**View Original MOU Template**

[View MOU](#)



Last Login: 05/04/2021 04:47 PM

U.S. Department of Homeland Security

<https://e-verify.uscis.gov/web/EmployerWizard.aspx>

179

5/4/2021

E-Verify: Employer Wizard - Company Information

U.S. Citizenship and Immigration Services

Enable Permanent Tooltips

Accessibility

Download Viewers

180

CITY OF MIAMI SPRINGS  
REQUEST FOR PROPOSALS NO. 01-20/21

**FORM 11**  
**IRS FORM W-9**

Please visit the following link for information about IRS Form W-9:

<https://www.irs.gov/forms-pubs/about-form-w-9>

Please complete and submit with the proposal IRS Form W-9, which may be found online by visiting:

<https://www.irs.gov/pub/irs-pdf/fw9.pdf>

Check here to confirm IRS Form W-9 has been submitted as part of the response.

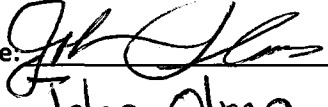
Firm: Greater Miami Caterers, Inc.  
Authorized Signature:  Date: 6/10/21  
Print or Type Name: John Olmo Title: Vice-President

## Request for Taxpayer Identification Number and Certification

**Give Form to the  
requester. Do not  
send to the IRS.**

▶ Go to [www.irs.gov/FormW9](http://www.irs.gov/FormW9) for instructions and the latest information.

Print or type.  
See Specific Instructions on page 3.

<b>1</b> Name (as shown on your income tax return). Name is required on this line; do not leave this line blank. <span style="font-size: 1.2em; font-family: cursive;">Greater Miami Caterers, Inc.</span>	
<b>2</b> Business name/disregarded entity name, if different from above	
<b>3</b> Check appropriate box for federal tax classification of the person whose name is entered on line 1. Check only <b>one</b> of the following seven boxes.	<b>4</b> Exemptions (codes apply only to certain entities, not individuals; see instructions on page 3):
<input type="checkbox"/> Individual/sole proprietor or single-member LLC	<input type="checkbox"/> C Corporation
<input type="checkbox"/> Limited liability company. Enter the tax classification (C=C corporation, S=S corporation, P=Partnership) ▶ _____	<input checked="" type="checkbox"/> S Corporation
<input type="checkbox"/> Partnership	<input type="checkbox"/> Trust/estate
<input type="checkbox"/> Other (see instructions) ▶ _____	Exempt payee code (if any) _____  Exemption from FATCA reporting code (if any) _____  <small>(Applies to accounts maintained outside the U.S.)</small>
<b>5</b> Address (number, street, and apt. or suite no.) See instructions. <span style="font-size: 1.2em; font-family: cursive;">4001 N.W. 31 Avenue</span>	Requester's name and address (optional)
<b>6</b> City, state, and ZIP code <span style="font-size: 1.2em; font-family: cursive;">Miami, FL 33142</span>	
<b>7</b> List account number(s) here (optional)	

### Part I Taxpayer Identification Number (TIN)

Enter your TIN in the appropriate box. The TIN provided must match the name given on line 1 to avoid backup withholding. For individuals, this is generally your social security number (SSN). However, for a resident alien, sole proprietor, or disregarded entity, see the instructions for Part I, later. For other entities, it is your employer identification number (EIN). If you do not have a number, see *How to get a TIN*, later.

**Note:** If the account is in more than one name, see the instructions for line 1. Also see *What Name and Number To Give the Requester* for guidelines on whose number to enter.

<b>Social security number</b>										
<table style="width: 100%; border-collapse: collapse;"> <tr> <td style="width: 25%; border: 1px solid black; height: 20px;"></td> <td style="width: 25%; border: 1px solid black; height: 20px;"></td> <td style="width: 25%; border: 1px solid black; height: 20px;"></td> <td style="width: 25%; border: 1px solid black; height: 20px;"></td> </tr> </table>										
or										
<b>Employer identification number</b>										
<table style="width: 100%; border-collapse: collapse;"> <tr> <td style="width: 12.5%; border: 1px solid black; text-align: center;">5</td> <td style="width: 12.5%; border: 1px solid black; text-align: center;">9</td> <td style="width: 12.5%; border: 1px solid black; text-align: center;">-</td> <td style="width: 12.5%; border: 1px solid black; text-align: center;">1</td> <td style="width: 12.5%; border: 1px solid black; text-align: center;">2</td> <td style="width: 12.5%; border: 1px solid black; text-align: center;">0</td> <td style="width: 12.5%; border: 1px solid black; text-align: center;">9</td> <td style="width: 12.5%; border: 1px solid black; text-align: center;">1</td> <td style="width: 12.5%; border: 1px solid black; text-align: center;">7</td> <td style="width: 12.5%; border: 1px solid black; text-align: center;">4</td> </tr> </table>	5	9	-	1	2	0	9	1	7	4
5	9	-	1	2	0	9	1	7	4	

### Part II Certification

Under penalties of perjury, I certify that:

- The number shown on this form is my correct taxpayer identification number (or I am waiting for a number to be issued to me); and
- I am not subject to backup withholding because: (a) I am exempt from backup withholding, or (b) I have not been notified by the Internal Revenue Service (IRS) that I am subject to backup withholding as a result of a failure to report all interest or dividends, or (c) the IRS has notified me that I am no longer subject to backup withholding; and
- I am a U.S. citizen or other U.S. person (defined below); and
- The FATCA code(s) entered on this form (if any) indicating that I am exempt from FATCA reporting is correct.

**Certification instructions.** You must cross out item 2 above if you have been notified by the IRS that you are currently subject to backup withholding because you have failed to report all interest and dividends on your tax return. For real estate transactions, item 2 does not apply. For mortgage interest paid, acquisition or abandonment of secured property, cancellation of debt, contributions to an individual retirement arrangement (IRA), and generally, payments other than interest and dividends, you are not required to sign the certification, but you must provide your correct TIN. See the instructions for Part II, later.

<b>Sign Here</b>	Signature of U.S. person ▶ <span style="font-size: 1.5em; font-family: cursive;">John Sloan</span>	Date ▶ <span style="font-size: 1.5em; font-family: cursive;">6/10/21</span>
------------------	--	---

### General Instructions

Section references are to the Internal Revenue Code unless otherwise noted.

**Future developments.** For the latest information about developments related to Form W-9 and its instructions, such as legislation enacted after they were published, go to [www.irs.gov/FormW9](http://www.irs.gov/FormW9).

### Purpose of Form

An individual or entity (Form W-9 requester) who is required to file an information return with the IRS must obtain your correct taxpayer identification number (TIN) which may be your social security number (SSN), individual taxpayer identification number (ITIN), adoption taxpayer identification number (ATIN), or employer identification number (EIN), to report on an information return the amount paid to you, or other amount reportable on an information return. Examples of information returns include, but are not limited to, the following.

- Form 1099-DIV (interest earned or paid)

- Form 1099-DIV (dividends, including those from stocks or mutual funds)
  - Form 1099-MISC (various types of income, prizes, awards, or gross proceeds)
  - Form 1099-B (stock or mutual fund sales and certain other transactions by brokers)
  - Form 1099-S (proceeds from real estate transactions)
  - Form 1099-K (merchant card and third party network transactions)
  - Form 1098 (home mortgage interest), 1098-E (student loan interest), 1098-T (tuition)
  - Form 1099-C (canceled debt)
  - Form 1099-A (acquisition or abandonment of secured property)
- Use Form W-9 only if you are a U.S. person (including a resident alien), to provide your correct TIN.
- If you do not return Form W-9 to the requester with a TIN, you might be subject to backup withholding. See What is backup withholding, later.*

By signing the filled-out form, you:

1. Certify that the TIN you are giving is correct (or you are waiting for a number to be issued),
2. Certify that you are not subject to backup withholding, or
3. Claim exemption from backup withholding if you are a U.S. exempt payee. If applicable, you are also certifying that as a U.S. person, your allocable share of any partnership income from a U.S. trade or business is not subject to the withholding tax on foreign partners' share of effectively connected income, and
4. Certify that FATCA code(s) entered on this form (if any) indicating that you are exempt from the FATCA reporting, is correct. See *What is FATCA reporting*, later, for further information.

**Note:** If you are a U.S. person and a requester gives you a form other than Form W-9 to request your TIN, you must use the requester's form if it is substantially similar to this Form W-9.

**Definition of a U.S. person.** For federal tax purposes, you are considered a U.S. person if you are:

- An individual who is a U.S. citizen or U.S. resident alien;
- A partnership, corporation, company, or association created or organized in the United States or under the laws of the United States;
- An estate (other than a foreign estate); or
- A domestic trust (as defined in Regulations section 301.7701-7).

**Special rules for partnerships.** Partnerships that conduct a trade or business in the United States are generally required to pay a withholding tax under section 1446 on any foreign partners' share of effectively connected taxable income from such business. Further, in certain cases where a Form W-9 has not been received, the rules under section 1446 require a partnership to presume that a partner is a foreign person, and pay the section 1446 withholding tax. Therefore, if you are a U.S. person that is a partner in a partnership conducting a trade or business in the United States, provide Form W-9 to the partnership to establish your U.S. status and avoid section 1446 withholding on your share of partnership income.

In the cases below, the following person must give Form W-9 to the partnership for purposes of establishing its U.S. status and avoiding withholding on its allocable share of net income from the partnership conducting a trade or business in the United States.

- In the case of a disregarded entity with a U.S. owner, the U.S. owner of the disregarded entity and not the entity;
- In the case of a grantor trust with a U.S. grantor or other U.S. owner, generally, the U.S. grantor or other U.S. owner of the grantor trust and not the trust; and
- In the case of a U.S. trust (other than a grantor trust), the U.S. trust (other than a grantor trust) and not the beneficiaries of the trust.

**Foreign person.** If you are a foreign person or the U.S. branch of a foreign bank that has elected to be treated as a U.S. person, do not use Form W-9. Instead, use the appropriate Form W-8 or Form 8233 (see Pub. 515, *Withholding of Tax on Nonresident Aliens and Foreign Entities*).

**Nonresident alien who becomes a resident alien.** Generally, only a nonresident alien individual may use the terms of a tax treaty to reduce or eliminate U.S. tax on certain types of income. However, most tax treaties contain a provision known as a "saving clause." Exceptions specified in the saving clause may permit an exemption from tax to continue for certain types of income even after the payee has otherwise become a U.S. resident alien for tax purposes.

If you are a U.S. resident alien who is relying on an exception contained in the saving clause of a tax treaty to claim an exemption from U.S. tax on certain types of income, you must attach a statement to Form W-9 that specifies the following five items.

1. The treaty country. Generally, this must be the same treaty under which you claimed exemption from tax as a nonresident alien.
2. The treaty article addressing the income.
3. The article number (or location) in the tax treaty that contains the saving clause and its exceptions.
4. The type and amount of income that qualifies for the exemption from tax.
5. Sufficient facts to justify the exemption from tax under the terms of the treaty article.

**Example.** Article 20 of the U.S.-China income tax treaty allows an exemption from tax for scholarship income received by a Chinese student temporarily present in the United States. Under U.S. law, this student will become a resident alien for tax purposes if his or her stay in the United States exceeds 5 calendar years. However, paragraph 2 of the first Protocol to the U.S.-China treaty (dated April 30, 1984) allows the provisions of Article 20 to continue to apply even after the Chinese student becomes a resident alien of the United States. A Chinese student who qualifies for this exception (under paragraph 2 of the first protocol) and is relying on this exception to claim an exemption from tax on his or her scholarship or fellowship income would attach to Form W-9 a statement that includes the information described above to support that exemption.

If you are a nonresident alien or a foreign entity, give the requester the appropriate completed Form W-8 or Form 8233.

## Backup Withholding

**What is backup withholding?** Persons making certain payments to you must under certain conditions withhold and pay to the IRS 24% of such payments. This is called "backup withholding." Payments that may be subject to backup withholding include interest, tax-exempt interest, dividends, broker and barter exchange transactions, rents, royalties, nonemployee pay, payments made in settlement of payment card and third party network transactions, and certain payments from fishing boat operators. Real estate transactions are not subject to backup withholding.

You will not be subject to backup withholding on payments you receive if you give the requester your correct TIN, make the proper certifications, and report all your taxable interest and dividends on your tax return.

**Payments you receive will be subject to backup withholding if:**

1. You do not furnish your TIN to the requester,
2. You do not certify your TIN when required (see the instructions for Part II for details),
3. The IRS tells the requester that you furnished an incorrect TIN,
4. The IRS tells you that you are subject to backup withholding because you did not report all your interest and dividends on your tax return (for reportable interest and dividends only), or
5. You do not certify to the requester that you are not subject to backup withholding under 4 above (for reportable interest and dividend accounts opened after 1983 only).

Certain payees and payments are exempt from backup withholding. See *Exempt payee code*, later, and the separate Instructions for the Requester of Form W-9 for more information.

Also see *Special rules for partnerships*, earlier.

## What is FATCA Reporting?

The Foreign Account Tax Compliance Act (FATCA) requires a participating foreign financial institution to report all United States account holders that are specified United States persons. Certain payees are exempt from FATCA reporting. See *Exemption from FATCA reporting code*, later, and the Instructions for the Requester of Form W-9 for more information.

## Updating Your Information

You must provide updated information to any person to whom you claimed to be an exempt payee if you are no longer an exempt payee and anticipate receiving reportable payments in the future from this person. For example, you may need to provide updated information if you are a C corporation that elects to be an S corporation, or if you no longer are tax exempt. In addition, you must furnish a new Form W-9 if the name or TIN changes for the account; for example, if the grantor of a grantor trust dies.

## Penalties

**Failure to furnish TIN.** If you fail to furnish your correct TIN to a requester, you are subject to a penalty of \$50 for each such failure unless your failure is due to reasonable cause and not to willful neglect.

**Civil penalty for false information with respect to withholding.** If you make a false statement with no reasonable basis that results in no backup withholding, you are subject to a \$500 penalty.

183

**Criminal penalty for falsifying information.** Willfully falsifying certifications or affirmations may subject you to criminal penalties including fines and/or imprisonment.

**Misuse of TINs.** If the requester discloses or uses TINs in violation of federal law, the requester may be subject to civil and criminal penalties.

## Specific Instructions

### Line 1

You must enter one of the following on this line; **do not** leave this line blank. The name should match the name on your tax return.

If this Form W-9 is for a joint account (other than an account maintained by a foreign financial institution (FFI)), list first, and then circle, the name of the person or entity whose number you entered in Part I of Form W-9. If you are providing Form W-9 to an FFI to document a joint account, each holder of the account that is a U.S. person must provide a Form W-9.

a. **Individual.** Generally, enter the name shown on your tax return. If you have changed your last name without informing the Social Security Administration (SSA) of the name change, enter your first name, the last name as shown on your social security card, and your new last name.

**Note: ITIN applicant:** Enter your individual name as it was entered on your Form W-7 application, line 1a. This should also be the same as the name you entered on the Form 1040/1040A/1040EZ you filed with your application.

b. **Sole proprietor or single-member LLC.** Enter your individual name as shown on your 1040/1040A/1040EZ on line 1. You may enter your business, trade, or "doing business as" (DBA) name on line 2.

c. **Partnership, LLC that is not a single-member LLC, C corporation, or S corporation.** Enter the entity's name as shown on the entity's tax return on line 1 and any business, trade, or DBA name on line 2.

d. **Other entities.** Enter your name as shown on required U.S. federal tax documents on line 1. This name should match the name shown on the charter or other legal document creating the entity. You may enter any business, trade, or DBA name on line 2.

e. **Disregarded entity.** For U.S. federal tax purposes, an entity that is disregarded as an entity separate from its owner is treated as a "disregarded entity." See Regulations section 301.7701-2(c)(2)(iii). Enter the owner's name on line 1. The name of the entity entered on line 1 should never be a disregarded entity. The name on line 1 should be the name shown on the income tax return on which the income should be reported. For example, if a foreign LLC that is treated as a disregarded entity for U.S. federal tax purposes has a single owner that is a U.S. person, the U.S. owner's name is required to be provided on line 1. If the direct owner of the entity is also a disregarded entity, enter the first owner that is not disregarded for federal tax purposes. Enter the disregarded entity's name on line 2, "Business name/disregarded entity name." If the owner of the disregarded entity is a foreign person, the owner must complete an appropriate Form W-8 instead of a Form W-9. This is the case even if the foreign person has a U.S. TIN.

### Line 2

If you have a business name, trade name, DBA name, or disregarded entity name, you may enter it on line 2.

### Line 3

Check the appropriate box on line 3 for the U.S. federal tax classification of the person whose name is entered on line 1. Check only one box on line 3.

IF the entity/person on line 1 is a(n) . . .	THEN check the box for . . .
• Corporation	Corporation
• Individual • Sole proprietorship, or • Single-member limited liability company (LLC) owned by an individual and disregarded for U.S. federal tax purposes.	Individual/sole proprietor or single-member LLC
• LLC treated as a partnership for U.S. federal tax purposes, • LLC that has filed Form 8832 or 2553 to be taxed as a corporation, or • LLC that is disregarded as an entity separate from its owner but the owner is another LLC that is not disregarded for U.S. federal tax purposes.	Limited liability company and enter the appropriate tax classification. (P= Partnership; C= C corporation; or S= S corporation)
• Partnership	Partnership
• Trust/estate	Trust/estate

### Line 4, Exemptions

If you are exempt from backup withholding and/or FATCA reporting, enter in the appropriate space on line 4 any code(s) that may apply to you.

#### Exempt payee code.

- Generally, individuals (including sole proprietors) are not exempt from backup withholding.
- Except as provided below, corporations are exempt from backup withholding for certain payments, including interest and dividends.
- Corporations are not exempt from backup withholding for payments made in settlement of payment card or third party network transactions.
- Corporations are not exempt from backup withholding with respect to attorneys' fees or gross proceeds paid to attorneys, and corporations that provide medical or health care services are not exempt with respect to payments reportable on Form 1099-MISC.

The following codes identify payees that are exempt from backup withholding. Enter the appropriate code in the space in line 4.

- 1—An organization exempt from tax under section 501(a), any IRA, or a custodial account under section 403(b)(7) if the account satisfies the requirements of section 401(f)(2)
- 2—The United States or any of its agencies or instrumentalities
- 3—A state, the District of Columbia, a U.S. commonwealth or possession, or any of their political subdivisions or instrumentalities
- 4—A foreign government or any of its political subdivisions, agencies, or instrumentalities
- 5—A corporation
- 6—A dealer in securities or commodities required to register in the United States, the District of Columbia, or a U.S. commonwealth or possession
- 7—A futures commission merchant registered with the Commodity Futures Trading Commission
- 8—A real estate investment trust
- 9—An entity registered at all times during the tax year under the Investment Company Act of 1940
- 10—A common trust fund operated by a bank under section 584(a)
- 11—A financial institution
- 12—A middleman known in the investment community as a nominee or custodian
- 13—A trust exempt from tax under section 664 or described in section 4947

184

The following chart shows types of payments that may be exempt from backup withholding. The chart applies to the exempt payees listed above, 1 through 13.

IF the payment is for . . .	THEN the payment is exempt for . . .
Interest and dividend payments	All exempt payees except for 7
Broker transactions	Exempt payees 1 through 4 and 6 through 11 and all C corporations. S corporations must not enter an exempt payee code because they are exempt only for sales of noncovered securities acquired prior to 2012.
Barter exchange transactions and patronage dividends	Exempt payees 1 through 4
Payments over \$600 required to be reported and direct sales over \$5,000 <sup>1</sup>	Generally, exempt payees 1 through 5 <sup>2</sup>
Payments made in settlement of payment card or third party network transactions	Exempt payees 1 through 4

<sup>1</sup> See Form 1099-MISC, Miscellaneous Income, and its instructions.

<sup>2</sup> However, the following payments made to a corporation and reportable on Form 1099-MISC are not exempt from backup withholding: medical and health care payments, attorneys' fees, gross proceeds paid to an attorney reportable under section 6045(f), and payments for services paid by a federal executive agency.

**Exemption from FATCA reporting code.** The following codes identify payees that are exempt from reporting under FATCA. These codes apply to persons submitting this form for accounts maintained outside of the United States by certain foreign financial institutions. Therefore, if you are only submitting this form for an account you hold in the United States, you may leave this field blank. Consult with the person requesting this form if you are uncertain if the financial institution is subject to these requirements. A requester may indicate that a code is not required by providing you with a Form W-9 with "Not Applicable" (or any similar indication) written or printed on the line for a FATCA exemption code.

A—An organization exempt from tax under section 501(a) or any individual retirement plan as defined in section 7701(a)(37)

B—The United States or any of its agencies or instrumentalities

C—A state, the District of Columbia, a U.S. commonwealth or possession, or any of their political subdivisions or instrumentalities

D—A corporation the stock of which is regularly traded on one or more established securities markets, as described in Regulations section 1.1472-1(c)(1)(i)

E—A corporation that is a member of the same expanded affiliated group as a corporation described in Regulations section 1.1472-1(c)(1)(i)

F—A dealer in securities, commodities, or derivative financial instruments (including notional principal contracts, futures, forwards, and options) that is registered as such under the laws of the United States or any state

G—A real estate investment trust

H—A regulated investment company as defined in section 851 or an entity registered at all times during the tax year under the Investment Company Act of 1940

I—A common trust fund as defined in section 584(a)

J—A bank as defined in section 581

K—A broker

L—A trust exempt from tax under section 664 or described in section 4947(a)(1)

M—A tax exempt trust under a section 403(b) plan or section 457(g) plan

**Note:** You may wish to consult with the financial institution requesting this form to determine whether the FATCA code and/or exempt payee code should be completed.

### Line 5

Enter your address (number, street, and apartment or suite number). This is where the requester of this Form W-9 will mail your information returns. If this address differs from the one the requester already has on file, write NEW at the top. If a new address is provided, there is still a chance the old address will be used until the payor changes your address in their records.

### Line 6

Enter your city, state, and ZIP code.

## Part I. Taxpayer Identification Number (TIN)

**Enter your TIN in the appropriate box.** If you are a resident alien and you do not have and are not eligible to get an SSN, your TIN is your IRS individual taxpayer identification number (ITIN). Enter it in the social security number box. If you do not have an ITIN, see *How to get a TIN* below.

If you are a sole proprietor and you have an EIN, you may enter either your SSN or EIN.

If you are a single-member LLC that is disregarded as an entity separate from its owner, enter the owner's SSN (or EIN, if the owner has one). Do not enter the disregarded entity's EIN. If the LLC is classified as a corporation or partnership, enter the entity's EIN.

**Note:** See *What Name and Number To Give the Requester*, later, for further clarification of name and TIN combinations.

**How to get a TIN.** If you do not have a TIN, apply for one immediately. To apply for an SSN, get Form SS-5, Application for a Social Security Card, from your local SSA office or get this form online at [www.SSA.gov](http://www.SSA.gov). You may also get this form by calling 1-800-772-1213. Use Form W-7, Application for IRS Individual Taxpayer Identification Number, to apply for an ITIN, or Form SS-4, Application for Employer Identification Number, to apply for an EIN. You can apply for an EIN online by accessing the IRS website at [www.irs.gov/Businesses](http://www.irs.gov/Businesses) and clicking on Employer Identification Number (EIN) under Starting a Business. Go to [www.irs.gov/Forms](http://www.irs.gov/Forms) to view, download, or print Form W-7 and/or Form SS-4. Or, you can go to [www.irs.gov/OrderForms](http://www.irs.gov/OrderForms) to place an order and have Form W-7 and/or SS-4 mailed to you within 10 business days.

If you are asked to complete Form W-9 but do not have a TIN, apply for a TIN and write "Applied For" in the space for the TIN, sign and date the form, and give it to the requester. For interest and dividend payments, and certain payments made with respect to readily tradable instruments, generally you will have 60 days to get a TIN and give it to the requester before you are subject to backup withholding on payments. The 60-day rule does not apply to other types of payments. You will be subject to backup withholding on all such payments until you provide your TIN to the requester.

**Note:** Entering "Applied For" means that you have already applied for a TIN or that you intend to apply for one soon.

**Caution:** A disregarded U.S. entity that has a foreign owner must use the appropriate Form W-8.

## Part II. Certification

To establish to the withholding agent that you are a U.S. person, or resident alien, sign Form W-9. You may be requested to sign by the withholding agent even if item 1, 4, or 5 below indicates otherwise.

For a joint account, only the person whose TIN is shown in Part I should sign (when required). In the case of a disregarded entity, the person identified on line 1 must sign. Exempt payees, see *Exempt payee code*, earlier.

**Signature requirements.** Complete the certification as indicated in items 1 through 5 below.

185



**1. Interest, dividend, and barter exchange accounts opened before 1984 and broker accounts considered active during 1983.** You must give your correct TIN, but you do not have to sign the certification.

**2. Interest, dividend, broker, and barter exchange accounts opened after 1983 and broker accounts considered inactive during 1983.** You must sign the certification or backup withholding will apply. If you are subject to backup withholding and you are merely providing your correct TIN to the requester, you must cross out item 2 in the certification before signing the form.

**3. Real estate transactions.** You must sign the certification. You may cross out item 2 of the certification.

**4. Other payments.** You must give your correct TIN, but you do not have to sign the certification unless you have been notified that you have previously given an incorrect TIN. "Other payments" include payments made in the course of the requester's trade or business for rents, royalties, goods (other than bills for merchandise), medical and health care services (including payments to corporations), payments to a nonemployee for services, payments made in settlement of payment card and third party network transactions, payments to certain fishing boat crew members and fishermen, and gross proceeds paid to attorneys (including payments to corporations).

**5. Mortgage interest paid by you, acquisition or abandonment of secured property, cancellation of debt, qualified tuition program payments (under section 529), ABLE accounts (under section 529A), IRA, Coverdell ESA, Archer MSA or HSA contributions or distributions, and pension distributions.** You must give your correct TIN, but you do not have to sign the certification.

**What Name and Number To Give the Requester**

For this type of account:	Give name and SSN of:
1. Individual	The individual
2. Two or more individuals (joint account) other than an account maintained by an FFI	The actual owner of the account or, if combined funds, the first individual on the account <sup>1</sup>
3. Two or more U.S. persons (joint account maintained by an FFI)	Each holder of the account
4. Custodial account of a minor (Uniform Gift to Minors Act)	The minor <sup>2</sup>
5. a. The usual revocable savings trust (grantor is also trustee)	The grantor-trustee <sup>1</sup>
b. So-called trust account that is not a legal or valid trust under state law	The actual owner <sup>1</sup>
6. Sole proprietorship or disregarded entity owned by an individual	The owner <sup>3</sup>
7. Grantor trust filing under Optional Form 1099 Filing Method 1 (see Regulations section 1.671-4(b)(2)(i)(A))	The grantor*

For this type of account:	Give name and EIN of:
8. Disregarded entity not owned by an individual	The owner
9. A valid trust, estate, or pension trust	Legal entity <sup>4</sup>
10. Corporation or LLC electing corporate status on Form 8832 or Form 2553	The corporation
11. Association, club, religious, charitable, educational, or other tax-exempt organization	The organization
12. Partnership or multi-member LLC	The partnership
13. A broker or registered nominee	The broker or nominee

For this type of account:	Give name and EIN of:
14. Account with the Department of Agriculture in the name of a public entity (such as a state or local government, school district, or prison) that receives agricultural program payments	The public entity
15. Grantor trust filing under the Form 1041 Filing Method or the Optional Form 1099 Filing Method 2 (see Regulations section 1.671-4(b)(2)(i)(B))	The trust

<sup>1</sup> List first and circle the name of the person whose number you furnish. If only one person on a joint account has an SSN, that person's number must be furnished.

<sup>2</sup> Circle the minor's name and furnish the minor's SSN.

<sup>3</sup> You must show your individual name and you may also enter your business or DBA name on the "Business name/disregarded entity" name line. You may use either your SSN or EIN (if you have one), but the IRS encourages you to use your SSN.

<sup>4</sup> List first and circle the name of the trust, estate, or pension trust. (Do not furnish the TIN of the personal representative or trustee unless the legal entity itself is not designated in the account title.) Also see *Special rules for partnerships*, earlier.

\*Note: The grantor also must provide a Form W-9 to trustee of trust.

Note: If no name is circled when more than one name is listed, the number will be considered to be that of the first name listed.

**Secure Your Tax Records From Identity Theft**

Identity theft occurs when someone uses your personal information such as your name, SSN, or other identifying information, without your permission, to commit fraud or other crimes. An identity thief may use your SSN to get a job or may file a tax return using your SSN to receive a refund.

To reduce your risk:

- Protect your SSN,
- Ensure your employer is protecting your SSN, and
- Be careful when choosing a tax preparer.

If your tax records are affected by identity theft and you receive a notice from the IRS, respond right away to the name and phone number printed on the IRS notice or letter.

If your tax records are not currently affected by identity theft but you think you are at risk due to a lost or stolen purse or wallet, questionable credit card activity or credit report, contact the IRS Identity Theft Hotline at 1-800-908-4490 or submit Form 14039.

For more information, see Pub. 5027, Identity Theft Information for Taxpayers.

Victims of identity theft who are experiencing economic harm or a systemic problem, or are seeking help in resolving tax problems that have not been resolved through normal channels, may be eligible for Taxpayer Advocate Service (TAS) assistance. You can reach TAS by calling the TAS toll-free case intake line at 1-877-777-4778 or TTY/TDD 1-800-829-4059.

**Protect yourself from suspicious emails or phishing schemes.**

Phishing is the creation and use of email and websites designed to mimic legitimate business emails and websites. The most common act is sending an email to a user falsely claiming to be an established legitimate enterprise in an attempt to scam the user into surrendering private information that will be used for identity theft.

186

The IRS does not initiate contacts with taxpayers via emails. Also, the IRS does not request personal detailed information through email or ask taxpayers for the PIN numbers, passwords, or similar secret access information for their credit card, bank, or other financial accounts.

If you receive an unsolicited email claiming to be from the IRS, forward this message to [phishing@irs.gov](mailto:phishing@irs.gov). You may also report misuse of the IRS name, logo, or other IRS property to the Treasury Inspector General for Tax Administration (TIGTA) at 1-800-366-4484. You can forward suspicious emails to the Federal Trade Commission at [spam@uce.gov](mailto:spam@uce.gov) or report them at [www.ftc.gov/complaint](http://www.ftc.gov/complaint). You can contact the FTC at [www.ftc.gov/idtheft](http://www.ftc.gov/idtheft) or 877-IDTHEFT (877-438-4338). If you have been the victim of identity theft, see [www.IdentityTheft.gov](http://www.IdentityTheft.gov) and Pub. 5027.

Visit [www.irs.gov/IdentityTheft](http://www.irs.gov/IdentityTheft) to learn more about identity theft and how to reduce your risk.

## Privacy Act Notice

Section 6109 of the Internal Revenue Code requires you to provide your correct TIN to persons (including federal agencies) who are required to file information returns with the IRS to report interest, dividends, or certain other income paid to you; mortgage interest you paid; the acquisition or abandonment of secured property; the cancellation of debt; or contributions you made to an IRA, Archer MSA, or HSA. The person collecting this form uses the information on the form to file information returns with the IRS, reporting the above information. Routine uses of this information include giving it to the Department of Justice for civil and criminal litigation and to cities, states, the District of Columbia, and U.S. commonwealths and possessions for use in administering their laws. The information also may be disclosed to other countries under a treaty, to federal and state agencies to enforce civil and criminal laws, or to federal law enforcement and intelligence agencies to combat terrorism. You must provide your TIN whether or not you are required to file a tax return. Under section 3406, payers must generally withhold a percentage of taxable interest, dividend, and certain other payments to a payee who does not give a TIN to the payer. Certain penalties may also apply for providing false or fraudulent information.

187

**Attachment - A**

Attachment-A

CITY OF MIAMI SPRINGS  
REQUEST FOR PROPOSALS NO. 01-20/21

ATTACHMENT A  
FORM OF PROFESSIONAL SERVICES AGREEMENT

PROFESSIONAL SERVICES AGREEMENT  
BETWEEN  
THE CITY OF MIAMI SPRINGS  
AND  
NAME OF ENTITY

**THIS AGREEMENT** (this "Agreement") is made effective as of the \_\_\_\_\_ day of \_\_\_\_\_, 2020 (the "Effective Date"), by and between the **CITY OF MIAMI SPRINGS, FLORIDA**, a Florida municipal corporation, (the "City"), and **NAME OF ENTITY**, a [type of entity authorized to do business in Florida] (hereinafter, the "Contractor").

**WHEREAS**, on [INSERT DATE], the City issued Request for Proposals No. 01-20/21 ("RFP") for **CONGREGATE & HOME-DELIVERED MEALS FOR THE CITY OF MIAMI SPRINGS ELDERLY COMMUNITY**, which RFP is incorporated herein by reference; and

**WHEREAS**, the services needed by the City are specifically identified in Section 2 of the RFP (the "Services"), which Section 2 of the RFP is incorporated herein and attached hereto as Exhibit "A"; and

**WHEREAS**, in response to the RFP, on [INSERT DATE], the Contractor submitted a Proposal dated [INSERT DATE OF CONTRACTOR'S PROPOSAL] for the Services, which Proposal is incorporated herein by reference (the "Proposal"); and

**WHEREAS**, on [INSERT DATE], the City Council adopted Resolution No. [INSERT NUMBER], selecting the Contractor to provide the Services and approving an agreement with the Contractor; and

**WHEREAS**, the Contractor will perform the Services for the City, as further described in Contractor's Proposal; and

**WHEREAS**, the Contractor and the City, through mutual negotiation, have agreed upon the compensation schedule set forth in the Price Proposal (Form 12 of the RFP) attached hereto as Exhibit "B" (the "Fee Schedule") for the Services; and

**WHEREAS**, the City desires to engage the Contractor to perform the Services and provide the deliverables as specified below.

**NOW, THEREFORE**, in consideration of the mutual covenants and conditions contained herein, the Contractor and the City agree as follows:

1. Scope of Services.

189

**CITY OF MIAMI SPRINGS**  
**REQUEST FOR PROPOSALS NO. 01-20/21**

- 1.1. Contractor shall provide the Services set forth in Exhibit "A" incorporated herein by reference (the "Services").
  - 1.2. Contractor shall furnish all reports, documents, and information obtained pursuant to this Agreement, and recommendations during the term of this Agreement (hereinafter "Deliverables") to the City.
  - 1.3. The Contractor shall abide by the terms and requirements of the RFP, as though fully set forth herein.
- 2. Term/Commencement Date.**
- 2.1. The term of this Agreement shall be from the Effective Date through one (1) year thereafter, unless earlier terminated in accordance with Paragraph 8. Additionally, the City Manager may renew this Agreement for up to five (5) additional one (1) year periods on the same terms as set forth herein upon written notice to the Contractor.
  - 2.2. Contractor agrees that time is of the essence and Contractor shall complete the Services within the term of this Agreement, unless extended by the City Manager.
- 3. Compensation and Payment.**
- 3.1. Compensation for Services provided by Contractor shall be in accordance with the Fee Schedule attached hereto as Exhibit "C" (the "Fee Schedule"). Additional expenses that are not included in the Fee Schedule must be pre-approved, in writing by the City and will be considered as line item reimbursements, without markup.
  - 3.2. Contractor shall deliver an invoice to the City no more often than once per month detailing Services completed and the amount due to Contractor under this Agreement. Contractor's invoices shall be delivered in accordance with Attachment D of the RFP. Fees shall be paid in arrears each month, pursuant to Contractor's invoice, which shall be based upon the percentage of work completed for each task invoiced. The City shall pay the Contractor in accordance with the Florida Prompt Payment Act after approval and acceptance of the Services by the City Manager.
  - 3.3. The City is exempt from sales tax. Accordingly, Contractor shall not collect sales tax from the City. The City shall provide a copy of its tax-exempt certificate upon request.
- 4. Subcontractors.**
- 4.1. The Contractor shall be responsible for all payments to any subcontractors and shall maintain responsibility for all work related to the Services and/or any Project.
  - 4.2. Contractor may only utilize the services of a particular subcontractor with the prior written approval of the City Manager, which approval may be granted or withheld in the City Manager's sole and absolute discretion.
- 5. City's Responsibilities.**

**CITY OF MIAMI SPRINGS  
REQUEST FOR PROPOSALS NO. 01-20/21**

- 5.1. City shall make available any maps, plans, existing studies, reports, staff and representatives, and other data pertinent to the Services and in possession of the City, and provide criteria requested by Contractor to assist Contractor in performing the Services.
- 5.2. Upon Contractor's request, City shall reasonably cooperate in arranging access to public information that may be required for Contractor to perform the Services.
- 6. Contractor's Responsibilities; Representations and Warranties.**
- 6.1. The Contractor shall exercise the same degree of care, skill and diligence in the performance of the Services for each Project as is ordinarily provided by a Contractor under similar circumstances. If at any time during the term of this Agreement or within two (2) years from the completion of this Agreement, it is determined that the Contractor's Deliverables or Services are incorrect, not properly rendered, defective, or fail to conform to City requests, the Contractor shall at Contractor's sole expense, immediately correct its Deliverables or Services.
- 6.2. The Contractor hereby warrants and represents that at all times during the term of this Agreement it shall maintain in good standing all required licenses, certifications and permits required under Federal, State and local laws applicable to and necessary to perform the Services for City as an independent contractor of the City. Contractor further warrants and represents that it has the required knowledge, expertise, and experience to perform the Services and carry out its obligations under this Agreement in a professional and first class manner.
- 6.3. The Contractor represents that is an entity validly existing and in good standing under the laws of Florida. The execution, delivery and performance of this Agreement by Contractor have been duly authorized, and this Agreement is binding on Contractor and enforceable against Contractor in accordance with its terms. No consent of any other person or entity to such execution, delivery and performance is required.
- 7. Conflict of Interest.**
- 7.1. To avoid any conflict of interest or any appearance thereof, Contractor shall not, for the term of this Agreement, provide any consulting services to any private sector entities (developers, corporations, real estate investors, etc.), with any current, or foreseeable, adversarial issues in the City.
- 8. Termination.**
- 8.1. The City Manager, without cause, may terminate this Agreement upon five (5) calendar days' written notice to the Contractor, or immediately with cause.
- 8.2. Upon receipt of the City's written notice of termination, Contractor shall immediately stop work on the project unless directed otherwise by the City Manager.
- 8.3. In the event of termination by the City, the Contractor shall be paid for all work accepted by the City Manager up to the date of termination, provided that the Contractor has first complied with the provisions of Paragraph 8.4.

**CITY OF MIAMI SPRINGS  
REQUEST FOR PROPOSALS NO. 01-20/21**

**8.4.** The Contractor shall transfer all books, records, reports, working drafts, documents, maps, and data pertaining to the Services and the project to the City, in a hard copy and electronic format within fourteen (14) days from the date of the written notice of termination or the date of expiration of this Agreement.

**9. Insurance.**

**9.1.** Contractor shall secure and maintain throughout the duration of this agreement insurance of such types and in such amounts not less than those specified below as satisfactory to City, naming the City as an Additional Insured, underwritten by a firm rated A-X or better by A.M. Best and qualified to do business in the State of Florida. The insurance coverage shall be primary insurance with respect to the City, its officials, employees, agents, and volunteers naming the City as additional insured. Any insurance maintained by the City shall be in excess of the Contractor's insurance and shall not contribute to the Contractor's insurance. The insurance coverages shall include at a minimum the amounts set forth in this section and may be increased by the City as it deems necessary or prudent.

9.1.1. Commercial General Liability coverage with limits of liability of not less than a \$1,000,000 per Occurrence combined single limit for Bodily Injury and Property Damage. This Liability Insurance shall also include Completed Operations and Product Liability coverages and eliminate the exclusion with respect to property under the care, custody and control of Contractor. The General Aggregate Liability limit and the Products/Completed Operations Liability Aggregate limit shall be in the amount of \$2,000,000 each.

9.1.2. Workers Compensation and Employer's Liability insurance, to apply for all employees for statutory limits as required by applicable State and Federal laws. The policy(ies) must include Employer's Liability with minimum limits of \$1,000,000.00 each accident. No employee, subcontractor or agent of the Contractor shall be allowed to provide Services pursuant to this Agreement who is not covered by Worker's Compensation insurance.

9.1.3. Business Automobile Liability with minimum limits of \$1,000,000 per occurrence, combined single limit for Bodily Injury and Property Damage. Coverage must be afforded on a form no more restrictive than the latest edition of the Business Automobile Liability policy, without restrictive endorsements, as filed by the Insurance Service Office, and must include Owned, Hired, and Non-Owned Vehicles.

**9.2. Certificate of Insurance.** Certificates of Insurance shall be provided to the City, reflecting the City as an Additional Insured (except with respect to Professional Liability Insurance and Worker's Compensation Insurance), no later than ten (10) days after award of this Agreement and prior to the execution of this Agreement by City and prior to commencing Services. Each certificate shall include no less than (30) thirty-day advance written notice to City prior to cancellation, termination, or material alteration of said policies or insurance. The Contractor shall be responsible for assuring that the insurance certificates required by this Section remain in full force and effect for the duration of this Agreement, including any extensions or renewals that may be granted by the City. The Certificates of Insurance shall not only name the types of policy(ies) provided, but also shall refer specifically to this Agreement and shall state that such insurance is as required by this Agreement. The City reserves the right to inspect and return a certified copy of such policies, upon written request by the City. If a policy is due to expire prior

**CITY OF MIAMI SPRINGS  
REQUEST FOR PROPOSALS NO. 01-20/21**

to the completion of the Services, renewal Certificates of Insurance shall be furnished thirty (30) calendar days prior to the date of their policy expiration. Each policy certificate shall be endorsed with a provision that not less than thirty (30) calendar days' written notice shall be provided to the City before any policy or coverage is cancelled or restricted. Acceptance of the Certificate(s) is subject to approval of the City.

- 9.3. Additional Insured.** Except with respect to Professional Liability Insurance and Worker's Compensation Insurance, the City is to be specifically included as an Additional Insured for the liability of the City resulting from Services performed by or on behalf of the Contractor in performance of this Agreement. The Contractor's insurance, including that applicable to the City as an Additional Insured, shall apply on a primary basis and any other insurance maintained by the City shall be in excess of and shall not contribute to the Contractor's insurance. The Contractor's insurance shall contain a severability of interest provision providing that, except with respect to the total limits of liability, the insurance shall apply to each Insured or Additional Insured (for applicable policies) in the same manner as if separate policies had been issued to each.
- 9.4. Deductibles.** All deductibles or self-insured retentions must be declared to and be reasonably approved by the City. The Contractor shall be responsible for the payment of any deductible or self-insured retentions in the event of any claim.
- 9.5.** The provisions of this section shall survive termination of this Agreement.
- 10. Nondiscrimination.** During the term of this Agreement, Contractor shall not discriminate against any of its employees or applicants for employment because of their race, color, religion, sex, or national origin, and will abide by all Federal and State laws regarding nondiscrimination.
- 11. Attorneys Fees and Waiver of Jury Trial.**
- 11.1.** In the event of any litigation arising out of this Agreement, the prevailing party shall be entitled to recover its attorneys' fees and costs, including the fees and expenses of any paralegals, law clerks and legal assistants, and including fees and expenses charged for representation at both the trial and appellate levels.
- 11.2.** IN THE EVENT OF ANY LITIGATION ARISING OUT OF THIS AGREEMENT, EACH PARTY HEREBY KNOWINGLY, IRREVOCABLY, VOLUNTARILY AND INTENTIONALLY WAIVES ITS RIGHT TO TRIAL BY JURY.
- 12. Indemnification.**
- 12.1.** Contractor shall indemnify and hold harmless the City, its officers, agents and employees, the Alliance for Aging, and the Florida Department of Elder Affairs from and against any and all demands, claims, losses, suits, liabilities, causes of action, judgment or damages, arising from Contractor's performance or non-performance of any provision of this Agreement, including, but not limited to, liabilities arising from contracts between the Contractor and third parties made pursuant to this Agreement. Contractor shall reimburse the City for all its expenses including reasonable attorneys' fees and costs incurred in and about the defense of any such claim or



**CITY OF MIAMI SPRINGS  
REQUEST FOR PROPOSALS NO. 01-20/21**

investigation and for any judgment or damages arising from Contractor's performance or non-performance of this Agreement.

- 12.2.** Nothing herein is intended to serve as a waiver of sovereign immunity by the City nor shall anything included herein be construed as consent to be sued by third parties in any matter arising out of this Agreement or any other contract. The City is subject to section 768.28, Florida Statutes, as may be amended from time to time.
- 12.3.** The provisions of this section shall survive termination of this Agreement.
- 13. Patents and Royalties.** The Contractor shall pay all royalties and assume all costs arising from the use of any invention, design, process materials, equipment, product or device which is the subject of patent rights or copyrights. Contractor shall, at its own expense, hold harmless and defend the City against any claim, suit or proceeding brought against the City which is based upon a claim, whether rightful or otherwise, that the goods or services, or any part thereof, furnished under the contract, constitute an infringement of any patent or copyright of the United States. The Contractor shall pay all damages and costs awarded against the City in such matter.
- 14. Notices/Authorized Representatives.** Any notices required by this Agreement shall be in writing and shall be deemed to have been properly given if transmitted by hand-delivery, by registered or certified mail with postage prepaid return receipt requested, or by a private postal service, addressed to the parties (or their successors) at the addresses listed on the signature page of this Agreement or such other address as the party may have designated by proper notice.
- 15. Governing Law and Venue.** This Agreement shall be construed in accordance with and governed by the laws of the State of Florida. Venue for any proceedings arising out of this Agreement shall be proper exclusively in Miami-Dade County, Florida.
- 16. Entire Agreement/Modification/Amendment.**
- 16.1.** This writing contains the entire Agreement of the parties and supersedes any prior oral or written representations. No representations were made or relied upon by either party, other than those that are expressly set forth herein.
- 16.2.** No agent, employee, or other representative of either party is empowered to modify or amend the terms of this Agreement, unless executed with the same formality as this document.
- 17. Ownership and Access to Records and Audits.**
- 17.1.** Contractor acknowledges that all inventions, innovations, improvements, developments, methods, designs, analyses, drawings, reports, compiled information, and all similar or related information (whether patentable or not) which relate to Services to the City which are conceived, developed or made by Contractor during the term of this Agreement ("Work Product") belong to the City. Contractor shall promptly disclose such Work Product to the City and perform all actions reasonably requested by the City (whether during or after the term of this Agreement) to establish and confirm such ownership (including, without limitation, assignments, powers of attorney and other instruments).

**CITY OF MIAMI SPRINGS  
REQUEST FOR PROPOSALS NO. 01-20/21**

- 17.2.** Contractor agrees to keep and maintain public records in Contractor's possession or control in connection with Contractor's performance under this Agreement. The City Manager or her designee shall, during the term of this Agreement and for a period of three (3) years from the date of termination of this Agreement, have access to and the right to examine and audit any records of the Contractor involving transactions related to this Agreement. Contractor additionally agrees to comply specifically with the provisions of Section 119.0701, Florida Statutes. Contractor shall ensure that public records that are exempt or confidential and exempt from public records disclosure requirements are not disclosed, except as authorized by law, for the duration of the Agreement, and following completion of the Agreement until the records are transferred to the City.
- 17.3.** Upon request from the City's custodian of public records, Contractor shall provide the City with a copy of the requested records or allow the records to be inspected or copied within a reasonable time at a cost that does not exceed the cost provided by Chapter 119, Florida Statutes, or as otherwise provided by law.
- 17.4.** Unless otherwise provided by law, any and all records, including but not limited to reports, surveys, and other data and documents provided or created in connection with this Agreement are and shall remain the property of the City.
- 17.5.** Upon completion of this Agreement or in the event of termination by either party, any and all public records relating to the Agreement in the possession of the Contractor shall be delivered by the Contractor to the City Manager, at no cost to the City, within seven (7) days. All such records stored electronically by Contractor shall be delivered to the City in a format that is compatible with the City's information technology systems. Once the public records have been delivered upon completion or termination of this Agreement, the Contractor shall destroy any and all duplicate public records that are exempt or confidential and exempt from public records disclosure requirements.
- 17.6.** Any compensation due to Contractor shall be withheld until all records are received as provided herein.
- 17.7.** Contractor's failure or refusal to comply with the provisions of this section shall result in the immediate termination of this Agreement by the City.
- 17.8.** Notice Pursuant to Section 119.0701(2)(a), Florida Statutes. **IF THE CONTRACTOR HAS QUESTIONS REGARDING THE APPLICATION OF CHAPTER 119, FLORIDA STATUTES, TO THE CONTRACTOR'S DUTY TO PROVIDE PUBLIC RECORDS RELATING TO THIS AGREEMENT, CONTACT THE CUSTODIAN OF PUBLIC RECORDS: ERIKA GONZALEZ, MMC, 201 WESTWARD DRIVE, MIAMI SPRINGS, FL 33166, 305-805-5006, GONZALEZE@MIAMISPRINGS-FL.GOV.**
- 18. Nonassignability.** This Agreement shall not be assignable by Contractor unless such assignment is first approved by the City Manager. The City is relying upon the apparent qualifications and expertise of the Contractor, and such firm's familiarity with the City's area, circumstances and desires.

**CITY OF MIAMI SPRINGS**  
**REQUEST FOR PROPOSALS NO. 01-20/21**

19. **Severability.** If any term or provision of this Agreement shall to any extent be held invalid or unenforceable, the remainder of this Agreement shall not be affected thereby, and each remaining term and provision of this Agreement shall be valid and be enforceable to the fullest extent permitted by law.
20. **Independent Contractor.** The Contractor and its employees, volunteers and agents shall be and remain an independent contractor and not an agent or employee of the City with respect to all of the acts and services performed by and under the terms of this Agreement. This Agreement shall not in any way be construed to create a partnership, association or any other kind of joint undertaking, enterprise or venture between the parties.
21. **Compliance with Laws.** The Contractor shall comply with all applicable laws, ordinances, rules, regulations, and lawful orders of public authorities in carrying out Services under this Agreement, and in particular shall obtain all required permits from all jurisdictional agencies to perform the Services under this Agreement at its own expense.
22. **Waiver.** The failure of either party to this Agreement to object to or to take affirmative action with respect to any conduct of the other which is in violation of the terms of this Agreement shall not be construed as a waiver of the violation or breach, or of any future violation, breach or wrongful conduct.
23. **Survival of Provisions.** Any terms or conditions of either this Agreement that require acts beyond the date of the term of the Agreement, shall survive termination of the Agreement, shall remain in full force and effect unless and until the terms or conditions are completed and shall be fully enforceable by either party.
24. **Prohibition of Contingency Fees.** The Contractor warrants that it has not employed or retained any company or person, other than a bona fide employee working solely for the Contractor, to solicit or secure this Agreement, and that it has not paid or agreed to pay any person(s), company, corporation, individual or firm, other than a bona fide employee working solely for the Contractor, any fee, commission, percentage, gift, or any other consideration, contingent upon or resulting from the award or making of this Agreement.
25. **Public Entity Crimes Affidavit.** Contractor shall comply with Section 287.133, Florida Statutes (Public Entity Crimes Statute), notification of which is hereby incorporated herein by reference, including execution of any required affidavit.
26. **Counterparts.** This Agreement may be executed in several counterparts, each of which shall be deemed an original and such counterparts shall constitute one and the same instrument.
27. **Conflicts; Order of Priority.** This document without exhibits is referred to as the "Base Agreement." In the event of a conflict between the terms of this Base Agreement and any exhibits or attachments hereto, or any documents incorporated herein by reference, the conflict shall be resolved in the following order of priorities and the more stringent criteria for performance of the Services shall apply:
- 27.1. First Priority: Base Agreement;
- 27.2. Second Priority: Exhibit B – Fee Schedule (Form 12);

**CITY OF MIAMI SPRINGS  
REQUEST FOR PROPOSALS NO. 01-20/21**

- 27.3. Third Priority: Exhibit A – Section 2 from RFP No. 01-20/21;
- 27.4. Fourth Priority: Contractor’s Proposal dated June 10, 2021.
- 28. **Non-Exclusive Agreement.** The City reserves the right to procure or acquire similar Services from another Contractor while this Agreement is in full force and effect.

**[Remainder of page intentionally left blank. Signature pages follow.]**

**CITY OF MIAMI SPRINGS  
REQUEST FOR PROPOSALS NO. 01-20/21**

**IN WITNESS WHEREOF**, the parties hereto have caused this Agreement to be executed the day and year as first stated above.

**CITY OF MIAMI SPRINGS**

**CONTRACTOR**

By: \_\_\_\_\_  
William Alonso, CPA, CGFO  
City Manager

By: \_\_\_\_\_

Name: \_\_\_\_\_

Attest:

Title: \_\_\_\_\_

By: \_\_\_\_\_  
Erika Gonzalez, MMC  
City Clerk

Entity: \_\_\_\_\_

Approved as to form and legal sufficiency:

By: \_\_\_\_\_  
Weiss Serota Helfman Cole + Bierman, P.L.  
City Attorney

**Addresses for Notice:**

City of Miami Springs  
Attn: City Manager  
201 Westward Drive  
Miami Springs, FL 33166  
305-805-5011 (telephone)  
alonsow@miamisprings-fl.gov (email)

**Addresses for Notice:**

\_\_\_\_\_  
\_\_\_\_\_  
\_\_\_\_\_  
\_\_\_\_\_  
\_\_\_\_\_ (telephone)  
\_\_\_\_\_ (email)

**With a copy to:**

Weiss Serota Helfman Cole & Bierman, P.L.  
Attn: Haydee Sera, Esq.  
City of Miami Springs Attorney  
2525 Ponce de Leon Boulevard, Suite 700  
Coral Gables, FL 33134  
hsera@wsh-law.com (email)

**With a copy to:**

\_\_\_\_\_  
\_\_\_\_\_  
\_\_\_\_\_  
\_\_\_\_\_  
\_\_\_\_\_ (telephone)  
\_\_\_\_\_ (email)

198

**CITY OF MIAMI SPRINGS  
REQUEST FOR PROPOSALS NO. 01-20/21**

**EXHIBIT A – COPY OF SECTION 2 FROM RFP**

**SECTION 2**

**SCOPE OF SERVICES AND SPECIAL CONDITIONS**

- 2.35** The Contractor shall provide all necessary labor, materials, equipment, reports and expertise required to provide the services, including but not limited to the tasks identified herein, which shall collectively be referred to as the “Services.” For purposes of the bid, “Contractor” is defined as a profit-making organization or a non-profit corporation licensed in the State of Florida, and with production kitchens within the State of Florida, that intends to prepare food for sale and/or distribution and is in compliance with the Food and Drug Administration and the United States Department of Agriculture and all other applicable federal and state regulations.
- 2.36** The City may elect to have the selected Contractor(s) provide all of these services, some of the services, or none of these services. The selected Contractor(s) is/are not guaranteed any work by the City under this solicitation. All projects will be coordinated with the City Manager and/or Senior Center Manager.
- 2.37** Bid Preference. Preference may be given to the vendor that provides the best quality and the shortest time span between packaging and delivery of hot food. Bids indicating price in effect at times of shipment will be considered invalid. The bidder shall be responsible for all fees, taxes, and licenses required to operate under the resulting contract and such expenses shall not be paid by the City.
- 2.38** Competency of Bidders.
- 2.38.1** The Contractor must provide documentation of ability and capability in providing the number of meals required to be provided with bid response. Pre-award inspection of the bidder’s facility may be made prior to the award of contract. Bids will be considered only from firms which are regularly engaged in the business of providing good and/or services as described in this bid with a good record of performance for a reasonable period of time and have sufficient financial support, equipment, and organization to ensure that they can satisfactorily execute the services if awarded a contract under the terms and conditions herein stated. The terms “equipment or organization” as used herein shall be construed to mean a fully equipped and well-established company in line with the best business practices in the industry and as determined by the proper authorities.
- 2.38.2** Bidder must be in compliance with state and local fire, health, sanitation, and safety regulations applicable to the type of food preparation and meals delivery system used by Bidder and said regulations must be adhered to during all stages of food service operations.
- 2.38.3** The City may consider any evidence available regarding the financial, technical, and other qualification and abilities of a Bidder; including past performance and experience in making the award in the best interest of the City.
- 2.39** Default.
- 2.39.1** In the event that the Contractor should fail to meet the terms of these bid specifications in any way, or should it cease its contractual responsibilities, the Contractor will be in default.
- 2.39.2** In case of default of the awarded bid, the City may procure the articles or services from other sources and charge the Contractor for meals, supplies, and any excess cost or liquidated damages incurred (actual and consequential damages).
- 2.39.3** In the event that the Contractor fails to deliver any meal, meals, portion of a meal, or other food and supplies at the designated sites within forty-five (45) minutes of the previously agreed upon time, or if the food does not meet the proper specifications (i.e., it is not delivered at proper temperatures, it is not fit for human consumption, menu items are omitted or

199

**CITY OF MIAMI SPRINGS**  
**REQUEST FOR PROPOSALS NO. 01-20/21**

substituted without prior approval, or if supplies and containers are not delivered properly sealed or sanitized) the City is not required to pay and may procure a meal or meals or other foods and supplies elsewhere, deduct the price of the meals from Contractor and charge the Contractor the cost of such replacement supplies and/or meal, meals, and other food, plus the Nutrition Services Incentive Program's cash per meal allowance and any other expenses incurred by the City in procuring the replacement.

**2.39.4** Should the Contractor fail to adhere to the time schedule, deliver meals for a consecutive three (3) day period, fail to deliver meals for any (3) three days during a calendar month, then such action shall be deemed material non-performance of the contract and shall be justification for immediate cancellation of the contract.

**2.40** Bonding. The bidder shall be responsible for all fees for bonding of personnel and such expenses shall not be paid by the City.

**2.41** Audits. The Contractor's financial records must be open for audit purposes. The Contractor must supply all reports requested by the City, the Alliance for Aging, the Florida Department of Elder Affairs, the Administration on Aging, and the U.S. Department of Agriculture.

**2.42** Alliance for Aging Approval Required. Prior to the execution of a contract resulting from this solicitation, the Alliance for Aging, Inc. must approve the awarded vendor and contract. It is and shall be understood and agreed that such contract, as approved by the Alliance for Aging, Inc., shall be awarded and validly entered into between the Bidder and the City when written acceptance has been transmitted to the awardee by the City's authorized agent and that all requirements stipulated within this Request for Proposal will be strictly adhered to.

**2.43** Termination.

**2.43.1** The City may, by written notice to the successful Bidder, terminate the contract if the Bidder/Contractor has been found to have failed to perform his services in a matter satisfactory to the City as per specification including delivery as specified. It is the intention of the City to purchase the items specified herein from a source of supply that will give prompt, convenient, and proper shipment and service. Any failure of the supplier to comply with these conditions may be cause for terminating any resulting contract immediately upon written notice of the City. The City shall be the sole judge of non-performance/breach.

**2.43.2** In the event than any person eating meals prepared under this contract becomes ill as a result of food poisoning which is attributable to the negligence of the Contractor as determined by the Health Department Environmental Control Division, then such action shall be deemed material non- performance of the contract and City shall have justification for immediate cancellation of the contract.

**2.43.3** It is further agreed that, in the event funds to finance all or part of these Nutrition Programs for the Elderly become unavailable, the obligations of each party may be terminated upon no less than twenty (20) days' notice in writing to the other party. Said notice shall be in accordance with the notice provisions of the contract resulting from this RFP. The Florida Department of Elderly Affairs shall be final authority as to the availability of Federal or State Funds.

**2.44** Compliance with Laws.

**2.44.1** Bidders shall comply with all local, State, and Federal directives, orders and laws applicable to this bid and subsequent contract(s).

**2.44.2** Specific reference is made to 2020 Edition of the *DOEA Program and Services Handbook* (especially the sections contained in Attachment B of this document); Title VI and VII of the Civil Rights Acts; the Americans with Disabilities Act; and Section 504 of the vocational Rehabilitation Act of 1973.

**CITY OF MIAMI SPRINGS  
REQUEST FOR PROPOSALS NO. 01-20/21**

**2.44.3** Pursuant to the Civil Rights Act of 1964 and the Americans with Disabilities Act of 1990, all Contractors and Sub-Contractors performing work in connection with this contract shall provide equal opportunity for employment and shall agree not to discriminate against an employee or applicant for employment because of race, religion, color, age, sex, national origin, place of birth, veteran status disability, perceived disability or any other legally protected group. It is expressly understood that upon evidence of such discrimination, the City shall have the right to immediately terminate said contract.

**2.45 Contractor's Employees.**

**2.45.1** All employees of the Contractor are solely the employees of the Contractor under its direction and not employees or agents of the City. The Contractor shall be responsible for all its employees' salaries and benefits including worker's compensation premiums and benefits. The Contractor shall provide competent and physically able employees. The City may require the Contractor to remove any employee it deems careless, incompetent, insubordinate, or otherwise objectionable and whose continued employment on the City's properties, or at citizens' homes, is not in the best interest of the City. Each employee shall have and wear proper attire and identification. All employees working in the preparation of food must ensure the application of hygienic techniques and practices in food handling, preparation, and service. Employees involved with delivery of home delivered meal must have DOEA Level 2 background screening on file and bidder must ensure that consumers served are at no risk of harm from their employees. City may request proof of DOEA Level 2 background screening.

**2.45.2** The Contractor should have a working knowledge of the Nutrition Program for the Elderly. The Contractor shall be available to the City for menu planning, recipe modification, and other required technical assistance. The name and the after-hours telephone number of the person whose primary responsibility is the management of the food service contract must be provided to the City.

**2.45.3** Each nutrition site shall be visited at least semi-annually by a managerial representative of the food service company to determine the quality of service and acceptability of food by participants and to become acquainted with the program that they are serving. Lines of communication shall be open between the Contractor and the City. The Contractor shall agree to employ older workers, if possible. The Contractor shall provide ongoing training in personal hygiene, sanitation and food handling to its kitchen staff and delivery personnel.

**2.45.4** If requested, the Contractor shall provide training in portion control and food handling to the City's employees at a time and place mutually agreed upon.

**2.46 Contract Pricing; Adjustments**

**2.46.1** The purpose of this solicitation is to establish a Contract for the purchase of the City's total needs for an initial one year term. Quantities stated are for bidders' guidance only and no guarantee is given or implied as to quantities that will be used during the contract period. Estimated quantities are based upon previous needs and estimated usage for the initial one year term.

**2.46.2** The prices established herein shall prevail (be maximum) for the term of the Contract with the benefit of any general reduction in commodity price during said period being passed on to the City. The City has the option to extend the contract for five additional twelve (12) month periods. Extension of the Contract is a City prerogative, not a right of the Contractor. Such option will be exercised only when it is in the best interest of the City to do so.

**2.46.3** Extension of the contract for any option year may be based on a price adjustment. Ninety (90) days prior to the date of Contract termination, the Contractor shall submit requested price adjustments to the City who shall consider said information along with other criteria in evaluating



**CITY OF MIAMI SPRINGS  
REQUEST FOR PROPOSALS NO. 01-20/21**

whether or not to exercise the City's option to renew the contract for an additional year. Such requested price adjustment shall, in any event, not exceed the percentage increase shown by the "Consumer Price Index for Food, Etc," published by the U.S. Department of Labor, Bureau of Statistics, for the 9th month after commencement of the services as compared with the index on the effective date of contract.

**2.47 RECORDS RETENTION.** The Contractor shall keep complete and accurate books, documents, papers and records (including electronic storage media) relating to the purchase of food and the storage, preparation, and transportation of the meals, including labor costs, raw food costs and records or receipts of storage and use of N.S.I.P. foods in accordance with generally accepted accounting procedures and practices consistently applied which sufficiently and properly reflect all revenues and expenditures of funds provided by the City of Miami Springs under the conditions of the Contract. Such records shall be kept for a period of at least six (6) years from the expiration or termination of the Contract. The books, documents and other records required to be maintained by the Contractor shall, upon their request and at a reasonable time and place, be made available for audit or examination purposes to authorized representatives of the City, the Department of Elder Affairs, the State Examiner or Public Accountant, the US Department of Health and Human Services, the US Comptroller General and another other Federal personnel pursuant to 7CFR 226. In the case of audit exception, all books, records, accounting records and other documents relative to this agreement, will be retained until such exception has been cleared or resolved to the satisfaction of these agencies.

**2.48 MONITORING REQUIREMENTS:**

**2.48.1** The Contractor will provide operational, sanitation, dietary, and fiscal reports as specified by the Area Agency on Aging and the City. These reports will be used for monitoring compliance with contractual stipulations.

**2.48.2** The Contractor will permit persons duly authorized by the City and the Alliance for Aging to inspect any records, papers, documents, food preparation areas, packaging and storage areas, food containers, automotive vehicles of the Provider, which are relevant to this contract, and/or interview any clients and employees of the Contractor to be assured of satisfactory performance of the terms and conditions of this subcontract. Following such inspection, the City or Alliance for Aging will deliver to the City of Miami Springs a list of its comments with regard to the manner in which said goods or services are being provided.

**2.48.3** The Contractor will rectify all noted deficiencies within the specified period of time set forth in the comments, or provide the City with a reasonable and acceptable justification for not correcting the noted shortcomings. The Contractor's failure to correct or justify within a reasonable time as specified by the City may result in the withholding of payments, being deemed in breach or default, or termination of this subcontract.

**MINIMUM FOOD CONTRACT SPECIFICATIONS AND TERMS**

**2.49 Scope.** It is the intent of the City to secure a contract for the purchase of:

**2.49.1** approximately 125 hot Congregate Meals a day (with actual variances of 90—125 ordered daily), Monday through Friday, excluding holidays, to the City of Miami Springs Adult Community Center located at 100 Apache Drive, Miami Springs;

**2.49.2** approximately 65 hot Home-Delivered Hot Lunch Weekday Meals a day (with actual variances of 50--65 ordered daily), Monday through Friday, and 65 cold Home-Delivered Lunch meals delivered each day on Saturday and Sunday (with actual variances of 50--65 ordered daily), with delivery to the individual homes or apartments of homebound residents of Miami Springs and Virginia Gardens; and

**CITY OF MIAMI SPRINGS  
REQUEST FOR PROPOSALS NO. 01-20/21**

**2.49.3** approximately 65 weekday cold breakfast meals Home-Delivered (with actual variances of 50--65 ordered daily), delivered Monday-Sunday to the individual homes or apartments of homebound residents of Miami Springs, Florida.

**2.49.4** The locations and numbers of all Home-Delivered Meals are subject to change and will be established daily.

**2.50 DELIVERY SCHEDULE:**

**2.50.1** The total number of serving days will be a minimum of 253 for the contract year.

**2.50.2** Congregate Meals will NOT be delivered on Saturdays, Sundays, or days upon which the following holidays fall: New Year's Day; Martin Luther King Jr. Day; Memorial Day; Independence Day; Labor Day; Thanksgiving Day; Day after Thanksgiving; Veterans' Day; Christmas Day.

**2.50.3** Delivery schedules between food packaging and delivery should not exceed 4 hours.

**2.50.4** Congregate Meals must be delivered between 10:30 a.m. and 11:15 a.m. each weekday. Home-Delivered Meals are to be delivered between 11:30 a.m. and 1:30 p.m. each day. Deliveries made outside of the stated time range are not acceptable. The Contractor must adhere to a strict time schedule for delivering the congregate meal hot lunches and home delivered meal hot lunches.

**2.50.5** Deliveries made past the stated time range will result in the following:

**2.50.5.1** If congregate meals are received after 11:45 A.M., a thirty-three percent (33%) reduction on meal cost for the day will be made.

**2.50.5.2** If the meal is received after 12:00 noon, there will be reduction of fifty percent (50%).

**2.50.5.3** If the meal is delivered after 12:30 P.M., the project will not be liable for payment for meals delivered on that day.

**2.50.5.4** If for any reason City must procure meals from outside source due to non-delivery of meal, meal is spoiled or otherwise inedible; the contractor will be responsible for all costs incurred.

**2.50.5.5** City is not required to pay for meal that does not meet proper specifications.

**2.50.6** Upon delivery of meals to each congregate location, an authorized representative of the City shall sign a receipt in multiple copies evidencing receipt of such food, with two (2) copies to be retained by the Contractor and one (1) copy to be retained by the City. The delivery of disposable supplies shall occur at mutually convenient times between the City and the Contractor, and the type and number of surplus supplies to be stored at the City's site will be mutually agreed upon.

**2.51 FOOD CONTAINERS:**

**2.51.1** Food shall be delivered to nutrition site in bulk or individual meal containers. It shall be packaged so that there will be a minimum of spills in the carrier. The Contractor will take any necessary measures including, but not limited to, reducing fill level, and covering plates with stretch plastic film and/or aluminum foil and metal lids to prevent spillage. Carriers will be provided by the Contractor in a size and/or quantity to contain all food delivered to the site. Home delivered meals shall be individually packaged, packed in secondary insulated food carriers, and transported immediately under conditions that will ensure temperature control during delivery and prevent contamination and spillage. Cold and hot food shall be packaged and packed separately.

**2.51.2** All serving pans shall be of disposable aluminum and/or stainless steel. Any permanent ware will be retrieved by Contractor's personnel on the next delivery day and must be sanitized by the Contractor. Packaged materials must be supplied in containers that may be resealable

**CITY OF MIAMI SPRINGS  
REQUEST FOR PROPOSALS NO. 01-20/21**

after individual items are removed. Daily cleaning and sanitizing of utensils, pans, coolers, carriers, and all other equipment provided by the Contractor shall be the responsibility of the Contractor.

**2.52 ESTIMATED QUANTITIES:**

**2.52.1** It shall be understood and agreed that quantities designated herein are estimates only and may be increased or decreased in accordance with the actual normal requirements of the City, and that the City in accepting any bid or portion thereof, contracts only and agrees to purchase only the supplies, equipment, and services in such quantities as represent the actual requirements of the City on a day-to-day basis.

**2.52.2** The Contractor shall be flexible regarding the number of meals to be provided at each site from day to day and in the delivery location for home delivered meals. The City will notify the Contractor by 3:00 P.M. of each serving day the number of meals required for the next serving day. This will constitute a purchase order which will cover the maximum billings for that order. At the time the contract is awarded, the City will give the Contractor the names of the people who are authorized to make the number of meals notification.

**2.53 TRANSPORTATION AND DELIVERY:**

**2.53.1** All deliveries will be made in trucks or vans that are capable of holding food at the required temperatures, and be clean and well-maintained.

**2.53.2** The Contractor shall develop and submit with the bid an emergency procedure for delivering food in the case the vehicle breakdowns or the driver fails to report for work.

**2.54 EQUIPMENT:**

**2.54.1** No equipment will be furnished or maintained by the City in the provision of meals; therefore, the Contractor shall supply and maintain all approved transportation, insulated containers and other appropriate equipment, service-ware, cups, straws, napkins, accessories, and condiments appropriate for the storage, preparation, delivery, and the serving of hot and cold foods, abiding by all safety measures and sanitary practices in handling operations. The Contractor shall replace unsanitary and damaged equipment.

**2.55 MENUS:**

**2.55.1** Menus shall be written in accordance with the Department of Elder Affairs (DOEA) standards specified in Chapter 3 of the *DOEA Programs and Services Handbook*, excerpts of which are attached hereto as Attachment B (Pages 3-106 through 3-129: Menu Review and Approval; Pages 3-130 through 3-132: Food Purchasing/Preparation Standards; Pages 3-133 through 3-139: Food Preparation and Safety Standards; and Pages 3-143 through 3-147: Food Service Contract Provisions) and which provide specific instruction for nutrition program policies. Contractor is responsible to strict adherence to these guidelines.

**2.55.2** Each menu page must be labeled with a line for the City's Qualified Dietician to sign on indicating his/her approval of the menu with nutritional analysis, along with a line for their license number as follows: Dietician Sign Off with Nutritional Analysis [INSERT]. License No. [INSERT].

**2.55.3** Menus must be designed/developed using the computer assisted nutrient analysis method and which ensures target nutrients are served in accordance with current nutritional standards, while also allowing menu component flexibility.

**2.55.4** Menus must comply with the current Dietary Guidelines for Americans published by the Secretary of Health and Human Services and the Secretary of Agriculture ([https://www.dietaryguidelines.gov/sites/default/files/2019-05/2015-2020 Dietary Guidelines.pdf](https://www.dietaryguidelines.gov/sites/default/files/2019-05/2015-2020_Dietary_Guidelines.pdf)).

**2.55.5** Menus must comply with a minimum of 33 1/3% of the current Dietary Reference Intake nutritional needs of a 70+ moderately active female.

**CITY OF MIAMI SPRINGS  
REQUEST FOR PROPOSALS NO. 01-20/21**

- 2.55.6** Bidders are required to comply with semi-annual menu cycles (four week cycles for each six months).
- 2.55.7** Menu meal pattern must include appropriate portion size and identification of serving utensils to be used for each food item.
- 2.55.8** Menu must provide an indication of serving size of all menu components.
- 2.55.9** Menu must provide identification of serving utensil to be used for each food item.
- 2.56** TIMEFRAME FOR MENU SUBMISSION AND APPROVAL:
- 2.56.1** Following extensive collaboration with the City on planning all menus, the Contractor's Qualified Dietician will complete a computer assisted nutrition analysis of each menu and provide it to the City no less than eight (8) calendar weeks in advance of implementation. The City's Qualified Dietician will assure that provided menus comply with the nutritional analysis of each menu and will sign an Attestation Statement so certifying. Approved menu cycles may be repeated for the time periods of: January to June; and July to December. Menus must also be negotiated, and computer assisted nutritional analysis provided, for shelf stable boxed/emergency lunches and holiday meals.
- 2.56.2** Following the City's Qualified Dietician's analysis, menus will be submitted to the Alliance for Aging six (6) weeks prior to implementation for approval. Bidder should work in collaboration with City's Qualified Dietician in developing the menus in order to ensure compliance and ability of the Contractor to adhere to menu and to discuss ability to meet ethnic and regional preferences, seasoning, and preparation preferences and variety preferences.
- 2.57** MENU ACCEPTABILITY:
- 2.57.1** The City reserves the right to evaluate menu acceptability by its clientele and to require menu revisions when necessary.
- 2.58** MENU SUBSTITUTIONS:
- 2.58.1** Substitutions to the menu must be kept at a minimum and should be recorded and justified to the City. Any substitution of the menu must be in compliance with the City's pre-approved substitution list, which has been included as Attachment C. Substitutions to the approved menu cycles may not be made without prior approval by the City's Qualified Dietician, unless the food item is on the substitution list provided in Attachment C.
- 2.58.2** Substitutions must be a similar nutritional value and may not reduce the nutritional content of the meal.
- 2.58.3** Should the contractor expect that a substitution will be made in the future due to unavailability of an item, the request for substitution of a menu item must be made to the City in writing at least 2 weeks in advance in order to ensure that their consulting dietician has the proper amount of time to advise and approve of a suitable substitution.
- 2.58.4** The Contractor must provide the City a list of any and all substitutions made that include the date of substitution, the original menu items, the substitution made, and the reason for substitution to the City at the end of each month. It is mandatory that City be informed of the reason for substitution to keep on record. In the event that a substitution is made without prior approval, the City will not be responsible for payment for the unapproved menu item. Likewise, any menu item omitted will not be paid for by the City. The cost of said items shall be deducted from the bill at a rate to be determined at the time the contract is awarded. The Contractor shall provide immediate reimbursement for any out-of-pocket expenses incurred by the City when replacing part of or all of a meal that is not delivered or is not wholesome.
- 2.58.5** Contractor must provide a supply of substitution food items to be kept at the meal site in case a substitution is necessary.
- 2.59** SPECIAL MENU PROVISIONS:

**CITY OF MIAMI SPRINGS  
REQUEST FOR PROPOSALS NO. 01-20/21**

**2.59.1** The Contractor agrees to supply on a monthly basis, at no additional cost to the City, a 2½" square serving of birthday cake per person in place of the regular dessert item on an agreed date.

**2.59.2** The Contractor shall provide a traditional Thanksgiving, Christmas, and Easter meal, at no additional cost to the City, on a mutually agreed upon date. These meals will follow the holiday menus supplied by the Contractor and pre-approved by the City's Qualified Dietician and the Alliance for Aging, Inc.

**2.59.3** The Contractor agrees to furnish the aforementioned food for special occasions as scheduled by the City after a joint discussion of food service needs and with a seven (7) day advance notice.

**2.60 BOXED AND EMERGENCY LUNCHES:**

**2.60.1** As the City will be closed during certain holidays as stated in Section II Item B, the Contractor shall be prepared to supply boxed lunches at the same contracted meal unit cost to the City, if requested. The boxed lunch shall be delivered the day before the holiday for the same number of hot meals ordered that day. In addition, up to six (6) picnic meals may be requested by the City annually. These meals must be requested by the City at least one week prior to the serving date. Box lunches and picnic menu must also comply with all nutrition requirements and follow the menus initially provided by the Contractor and pre-approved by the City's Qualified Dietician.

**2.60.2** In any contract year, the City may request up to five menus for a take-home meal of non-perishable food for emergency use. The City shall request the non-perishable meals at least one week prior to the planned serving date.

**2.60.3** The Contractor agrees to have a contingency plan for supplying meals for at least 7 days in event of natural disasters, such as a hurricane, flood, fire, power failure, employee strikes, late supply shipments and similar circumstances which would prevent the Contractor from furnishing the meals in the usual fashion. Should the event or natural disaster be so severe that 7 days is not sufficient, the City may request additional meals.

**2.60.4** It is the responsibility of the City and the Contractor to provide each other with home telephone numbers and/or cell phone numbers for emergency use only.

**FOOD SANITATION AND SAFETY**

**2.61 FOOD PREPARATION AND SAFETY STANDARDS COMPLIANCE:**

**2.61.1** It is mandated that the Contractor strictly adheres to food preparation and safety standards as stated in Attachment B (Pages 3-133 through 3-139).

**2.61.2** All applicable health and sanitation requirements shall be adhered to at the food preparation site/catering facility. Local, State, and Federal program authorities must have the right to inspect the premises and request formal inspection by health officials if deemed necessary.

**2.61.3** The food service vendor must not have had any temporary or permanent closures, Administrative Complaints regarding food safety, or 12 or more high priority/significant findings on sanitation inspections within the past 12 months, beginning July 1, 2018. Per Department of Business and Professional Regulation, "high priority violations could contribute directly to a foodborne illness or injury and could pose a direct or significant threat to public health, safety, or welfare." Per Department of Health, "an unsatisfactory inspection means that the violations were a significant threat to public health and sanitation and require correction before the next routine inspection."

**CITY OF MIAMI SPRINGS  
REQUEST FOR PROPOSALS NO. 01-20/21**

**2.61.4** Meals may be prepared directly by provider (self-preparation kitchen) which serves one meal site or a central kitchen which serves many sites; or through a written contractual agreement with a vendor (school, restaurant, hospital); or a food service company and must comply with local, state (FAC 64E-11), and, if applicable, federal regulations.

**2.62 FOOD SAFETY MANAGEMENT:**

**2.62.1** The Contractor will provide documentation with its response to this Request for Proposal of their HACCP (Hazard Analysis Critical Control Point) food safety management program that addresses food safety issues such as: time/temperature, cross contamination, personal hygiene, proper storage procedures, holding and cooking of food items. This program must meet or exceed the minimum requirements of federal, state, municipal or other agencies authorized to inspect or accredit the food service operation. The Contractor must maintain this program in formal form at each central kitchen and this document is to be available for review upon request and at each annual inspection conducted by program staff or their representative.

**2.63 STATE INSPECTIONS:**

**2.63.1** The Contractor must provide documentation with this Request for Proposal of the food preparation inspections conducted by state regulatory authorities within the previous six months.

**2.63.2** The Contractor must provide documentation of the three most recent food preparation inspections conducted by the state regulatory authority.

**2.63.3** Following the award of contract, the City shall receive copies of inspection reports of the Contractor's facilities completed by health, sanitation, and safety officials within seventy-two (72) hours after receipt of the above by the contractor.

**2.63.4** The Contractor must provide a written plan of correction for any high priority or significant findings on sanitation inspections.

**2.63.5** The Contractor must notify the City immediately for any closures or Administrative Complaints regarding food safety; and notify the City within 24 hours of any sanitation inspections.

**2.64 DELIVERY STANDARDS:**

**2.64.1** The Contractor shall be responsible for the operation, insurance and maintenance of vehicles used in the delivery of food, supplies, etc. The Contractor will transport all food items in their own enclosed vehicles appropriate for delivery. All food transport equipment will be purchased, kept clean and be well-maintained by the Contractor. Food shall be packaged in equipment capable of maintaining hot food at 135° F or higher and cold food at 41° F or lower until the final site destination. The Contractor's personnel shall place cold food in the refrigeration units upon delivery to the City's meal site. All milk is to be iced down. The ice must be in a solid state at time of delivery. Temperatures of food at delivery will be confirmed with Contractor's personnel at arrival.

**2.64.2** In addition, the Contractor must deliver one home delivered test meal per month to the City's administrative office following the last delivery of the driver's route in order for the City to check temperature as part of quality compliance measure. If a problem with home delivered food temperatures is detected, more frequent monitoring will be conducted to ensure the problem is resolved. Documentation of the monitoring results will be maintained by the City.

**2.64.3** The contractor must provide a description of the vendor's delivery standards and sanitation that includes holding temperatures for transporting and serving food.

**2.65 OTHER INSPECTIONS:**

**2.65.1** The food preparation facility will be inspected annually by the City. Failure to comply with applicable health requirements shall result in termination of the contract.

**CITY OF MIAMI SPRINGS  
REQUEST FOR PROPOSALS NO. 01-20/21**

**2.65.2** The City's Qualified Dietician, the DOEA, and Alliance for Aging staff shall be able to inspect food preparation, packaging, and storage areas at any time.

**2.66 DISPOSABLE SUPPLIES:**

**2.66.1** Each Contractor shall provide specifications of the disposable items they propose to use and shall provide samples of their proposed packaging with the bid submittal. The Contractor shall be responsible for providing the following single service supplies to both congregate and home delivered sites with the following minimum specifications:

**2.66.1.1** 6 ounce Styrofoam cups for coffee, tea, juice, or water for congregate meals;

**2.66.1.2** 8 ounce Styrofoam soup bowls for soups, stews, chili, etc.;

**2.66.1.3** 5 compartment, sturdy Styrofoam tray for congregate meals (in which at least three (3) compartments will hold half a cup of liquid each without spillage into other compartments;

**2.66.1.4** 3 or 4 compartment, aluminum tray with fitted lid for home delivered meals.

**2.66.1.5** Plastic coffee stirrers

**2.66.1.6** 7"—8" individually wrapped straws;

**2.66.1.7** Plastic-ware and napkins sealed in cellophane packets to include: non-brittle, heavy duty plastic fork, spoon, serrated knife, 3-ply napkin, and a packet of iodized salt (1/3 ounce portion) and a packet of pepper (1/16 ounce portion);

**2.66.1.8** Individual packets of condiments to include ketchup, mustard, mayonnaise, tartar sauce, and relish will be provided when necessary to complete the meal. Salad dressing will be delivered in gallon jars/bottles on an as needed basis. Vinegar shall be provided when greens are on the menu;

**2.66.1.9** The delivery of disposable supplies shall occur at a time mutually convenient to the City and the Contractor. The number of surplus supplies to be stored at the Congregate Meal site shall be agreed upon by the City and the Contractor.

**2.66.1.10** Coffee, tea bags, individual packets of sugar, sugar substitute, milk and/or non-dairy creamer will be supplied by the Contractor on an as needed basis.

**2.67 FOOD STANDARDS:**

**2.67.1** The Contractor shall purchase all foods used in the preparation of meals pursuant to this contract. All food purchased shall be of good quality and shall be obtained from sources which conform to federal, state, and local regulatory standards for quality, sanitation and safety. Only commercially processed, frozen, or canned foods or food approved by the USDA and the FDA may be used. No food prepared, frozen or canned in the home may be used in meals. When delivered to the nutrition site and client's home, the food shall be wholesome and of good quality.

**2.67.2** The portion of the meal for which NSIP funding is received must be food grown in the US. The Contractor must provide City with a letter stating the percentage of US grown food that is utilized in the preparation of the menus.

**2.67.3** No salt, "Accent", or other sodium condiment may be used in the preparation of food. No individual meal shall exceed 100 mg of sodium. No added sugar may be used. The use of saturated fats must be restricted in the menu planning and meal preparation.

**2.68** 2020 Edition of the DOEA *Program and Services Handbook*. The Contractor shall ensure and abide by all of the *Food Service Contract Provisions* described on Pages 3-143 through 3-147 of Chapter 3

**CITY OF MIAMI SPRINGS  
REQUEST FOR PROPOSALS NO. 01-20/21**

of the 2020 Edition of the DOEA *Programs and Services Handbook*, which can be found attached hereto as Attachment B.

**END OF SECTION 2**



**Attachment - B**

Attachment-B

**CITY OF MIAMI SPRINGS  
REQUEST FOR PROPOSALS NO. 01-20/21**

**EXHIBIT B –FEE SCHEDULE**

[INSERT COPY OF CONTRACTOR'S PRICE PROPOSAL ON FORM 12 OF RFP]

**CITY OF MIAMI SPRINGS  
REQUEST FOR PROPOSALS NO. 01-20/21**

**ATTACHMENT B**

Attachment B of this RFP is comprised of excerpts from Chapter 3 of the 2020 Edition of the DOEA *Programs and Services Handbook*. The excerpts are listed as follows and provided herein:

- Pages 3-106 through 3-129: Menu Review and Approval;
- Pages 3-130 through 3-132: Food Purchasing/Preparation Standards;
- Pages 3-133 through 3-139: Food Preparation and Safety Standards; and
- Pages 3-143 through 3-147: Food Service Contract Provisions

A complete copy of Chapter 3 of the DOEA *Programs and Services Handbook* can be found online by visiting this link: <https://allianceforaging.org/wp-content/uploads/2020Chapter3OlderAmericansAct.pdf>

# **Chapter 3**

## **Title III and Title VII of the Older Americans Act (OAA)**

# DEPARTMENT OF ELDER AFFAIRS PROGRAMS AND SERVICES HANDBOOK

## Chapter 3: Older Americans Act (OAA)

### Section III: Service Requirements

### Nutrition Program Policies

---

#### **MENU REVIEW AND APPROVAL:**

- A. Menu Planning:** The menus shall be planned and provided to the qualified dietitian for review no less than **six calendar weeks** in advance of implementation.
- B. Menu Approval:** All menus must be approved at least **four calendar weeks** prior to implementation. All menus must be approved in writing by a qualified dietitian. The approving qualified dietitian's signature and date must be documented on each page of the approved and posted menu. The approving signature verifies that all menus comply with DOEA menu standards and applicable supporting nutrient analysis documentation is maintained. The AAA qualified dietitian or the nutrition program Qualified Dietitian may approve the menus. A qualified dietitian employed by the food vendor may not approve the menus, because this is a conflict of interest.
- C. Menu Cycle:** Nutrition Programs may choose to offer two types of menu cycles:
- 1. Preselect Menu:** daily menu offers only one entrée; or
  - 2. Selective Daily Menu:** offers two to three entrée choices.

The preselect menu cycle shall be no less than 4 weeks in rotation of different food combinations to assure variety of colors, flavors, and textures. Preselect cycle menus shall run for a maximum of six months before changing, and food items should not be repeated on consecutive days or consecutive days of the week.

Meal sites offering a selective menu (i.e., buffet style meal service or kiosk) may decrease the menu rotation and the same menu item may be repeated on consecutive days or consecutive days of the week. However, the program must monitor acceptance and ensure menu fatigue is avoided. Selective menus shall run for a maximum of six months before changing.

- D. Menu Revisions:** The AAA or nutrition program qualified dietitian may require menu revisions based upon a review or the results of client satisfaction surveys. Requested menu revisions will be given to the service provider at least two weeks prior to scheduled menu implementation.
- E. Menu Corrections:** Copies of corrected menus must be resubmitted to the AAA or nutrition program qualified dietitian within one week of receipt of comments or as otherwise directed.

# DEPARTMENT OF ELDER AFFAIRS PROGRAMS AND SERVICES HANDBOOK

## Chapter 3: Older Americans Act (OAA)

### Section III: Service Requirements:

### Nutrition Program Policies

---

- F. Menu Posting:** Approved preselect menus shall be dated and posted in a conspicuous location at each congregate nutrition site in a font size large enough for easy review by the participants. Nutrition programs that prepare their meals must also post a copy of their menus in the food preparation area.

Select Menu (i.e., buffet style or kiosk) approved menu shall be dated and posted on/near the buffet style serving line and should be printed in font size large enough for easy review.

- G. Menu Retention:** Dated and approved menu with supporting menu related documents must be kept on file, as served for a period of two years for audit purposes.
- H. Menu Adherence:** Approved menus shall be followed as written.
- I. Menu Substitutions:** A comprehensive menu substitution policy and procedure must be developed and approved by the nutrition program's qualified dietitian. The menu substitution policy must be available for the site manager's use. Each meal site shall maintain an on-site record of all substitutions that occur during the calendar year. Menu substitutions shall be minimal, but are allowed under the following conditions:
1. Menu substitutions must be from the same food group and provide equivalent nutritional value. For example, a fruit high in Vitamin C must be substituted with another fruit high in Vitamin C.
  2. Prior to use the nutrition program's qualified dietitian must approve the menu substitution policy and procedures and the menu substitution list. It is encouraged that the menu substitution list be inclusive and thorough.
  3. Documentation of all menu substitutions must be kept on file for at least two years for monitoring purposes. The documentation must include the date of substitution, the original menu item, the substitution made, the reason for the substitution and the signature of the employee authorizing the substitution. Finally, the volume and frequency of substitutions must be justified by the reasons provided. For example, a seasonal fruit may be substituted for a canned fruit.

DEPARTMENT OF ELDER AFFAIRS PROGRAMS AND SERVICES HANDBOOK

Chapter 3: Older Americans Act (OAA)

Section III: Service Requirements

Nutrition Program Policies

---

**J. Menu Development:**

1. Menus should be developed with consideration for the:
  - a. Special needs of the elderly;
  - b. Religious, ethnic, cultural, and regional dietary practices or preferences of clients, if reasonable and feasible;
  - c. Variety of food and preparation methods including color, combinations, texture, size, shape, taste, and appearance;
  - d. Seasonal availability of foods;
  - e. Availability of equipment for food preparation or meal delivery service; and
  - f. Budget.
2. **Menu Development Methods:** Menus may be developed using two different methods, computer assisted nutrient analysis or component meal pattern.
  - a. The computer assisted nutrient analysis method.
  - b. The component meal pattern menu development method..

# DEPARTMENT OF ELDER AFFAIRS PROGRAMS AND SERVICES HANDBOOK

## Chapter 3: Older Americans Act (OAA)

### Section III: Service Requirements

### Nutrition Program Policies

---

3. **Nutrient Requirements:** All meals, regardless of development method, will provide each participating older individual with a minimum of 33 1/3 percent of the current Dietary Reference Intake (<http://fnic.nal.usda.gov/dietary-guidance/dietary-reference-intakes>) and comply with the current Dietary Guidelines for Americans. The values required meet the nutritional needs of a moderately active 70+ female, reflecting the predominant state wide demographic. The AAA may authorize a Nutrition Program to alter the nutrient requirements of their menus if most the senior population served by the Nutrition Program differs from the statewide demographic. DOEA must be provided advance notification, in writing of the demographic differences of the site(s) and the exact menu changes.
  
4. **Computer Assisted Nutrient Analysis Menu Development:** This method of menu development must comply with the following:
  - a. DOEA menu development standards ensuring compliance with the most recent edition of the Dietary Guidelines for Americans, published by the Secretary of Health and Human Services and the Secretary of Agriculture (<http://www.health.gov/dietaryguidelines/>);
  - b. Providing a minimum of 33 1/3 percent of the Dietary Reference Intake/Adequate Intake (DRI/AI) for moderately active 70+ females as established by the Food and Nutrition Board of the Institute of Medicine of the National Academy of Sciences, if one meal is provided per day;
  - c. Providing a minimum of 66 2/3 percent of the DRI/AI, for a moderately active 70+ female, if two meals are provided per day;
  - d. Providing 100 percent of the DRI/AI, for a moderately active 70+ female, if three meals are provided per day;
  - e. Any special dietary needs of program clients to the maximum extent practicable; and
  - f. Applicable provisions of state or local laws regarding the safe and sanitary handling of food, equipment, and supplies used in the storage, preparation, service, and delivery of meals to an older individual. Ref. Chapter 64-E-11-Food Hygiene, F.A.C. (<http://fac.dos.state.fl.us>).



# DEPARTMENT OF ELDER AFFAIRS PROGRAMS AND SERVICES HANDBOOK

## Chapter 3: Older Americans Act (OAA)

### Section III: Service Requirements

### Nutrition Program Policies

---

#### **Computer-Assisted Menu Development Requirements:**

**Targeted Nutrients:** Table One represents the most current Dietary Reference Intakes and daily compliance range for target nutrients. The following nutrients are required to be analyzed for each component of each menu item: calories, protein, fat, fiber, calcium, zinc, sodium, potassium, vitamin B6, vitamin B12, vitamin C, and vitamin A (vegetable-derived/carotenoid sources). Calories, protein, fat, fiber, calcium, vitamin B6, and vitamin C must be provided in adequate amounts daily. Vitamin A, vitamin B12, zinc, magnesium, sodium, and potassium may be averaged over one week. Sodium may be averaged over one week; however, no one-meal amount may exceed 1000 milligrams. It is recommended that fortified foods should be used to meet vitamin B12 needs. Holidays and birthday celebration meals (two or fewer meal types per calendar month) may be excluded from the nutrient analysis.

DEPARTMENT OF ELDER AFFAIRS PROGRAMS AND SERVICES HANDBOOK

Chapter 3: Older Americans Act (OAA)

Section III: Service Requirements

Nutrition Program Policies

	1 meal/day 33 1/3 % DRI/AI	2 meals/day 67% DRI/AI	3 meals/day 100% DRI/AI
<b>Macronutrients</b>			
Kilocalories (1)	600	1200	1800
Protein grams (1) ~20% of total Kcal >14 grams from entrée per meal	30	60	90
Carbohydrate grams (1) ~50% of total Kcal	75	150	225
Fat grams (1) 20-35% of total Kcal	20	40	60
Saturated fat (1) <10% total Kcal	Limit intake		
Added sugars (1) <10% of total Kcal or 45 grams/day	Limit intake		
Dietary Fiber grams (2)	7	14	21
<b>Vitamins</b>			
A *(ug/d)(2)	233	46	700
C (mg/d) (2)	25	50	75
D (mcg/d) (2)	*6.7	*13.3	*20
E (mg/d) (2)	5	10	15
Thiamine (mg/d) (2)	0.37	0.73	1.1
Riboflavin (mg/d) (2)	0.37	0.73	1.1
B6 (mg/d) (2)	0.5	1.0	1.5
Folate (ug/d) (2)	133	267	400
B12 (mcg/d) (2)	0.8	1.6	2.4
<b>Minerals</b>			
Calcium (mg/d) (2)	400	800	1200
Copper (ug/d) (2)	300	600	900
Iron (mg/d) (2)	2.7	45.3	8
Magnesium (mg/d) (2)	106.7	213.3	320
Zinc (mg/d) (2)	2.7	5.3	8
Potassium (mg/d) (1))	1567	3134	4700
Sodium (mg/d) (1)	<767	<1533	<2300

\*RDA's are in bold type and AI's are in ordinary type followed by an asterisk (\*).

- (1) Value for 70 +, moderately active female, USDA interpretation of the Dietary Guidelines for Americans 2015 U.S. Department of Agriculture. U.S. Department of Health and Human Services. <http://www.health.gov/dietaryguidelines/2015/guidelines/appendix7/>
- (2) Used highest DRI value for ages > 70-year-old female by Food and Nutrition Board of the Institute of Medicine of the National Academy of Sciences, includes the 2015 updated recommendations for calcium and vitamin D.

# DEPARTMENT OF ELDER AFFAIRS PROGRAMS AND SERVICES HANDBOOK

## Chapter 3: Older Americans Act (OAA)

### Section III: Service Requirements

### Nutrition Program Policies

---

**Component Meal Pattern Requirements for Menu Development:** This method of menu development must comply with the following:

- A. DOEA menu development standards ensuring the most recent edition of the Dietary Guidelines for Americans, published by the Secretary of Health and Human Services and the Secretary of Agriculture (<http://fnic.nal.usda.gov/dietary-guidance/dietary-reference-intakes/dri-tables>).
- B. Provide the minimum meal servings of the 1800-calorie component meal pattern to reflect the current Dietary Guidelines for Americans and USDA Food Intake Pattern calorie levels for a moderately active 70+-year-old female;
- C. Provide a minimum of two times the minimum meal servings of the 1800-calorie component meal pattern, if two meals are provided per day;
- D. Provide a minimum of three times the minimum meal servings of the 1800-calorie component meal pattern, if three meals are provided per day;
- E. Any special dietary needs of program clients to the maximum extent practicable; and
- F. Applicable provisions of state or local laws regarding the safe and sanitary handling of food, equipment and supplies used in the storage, preparation, service, and delivery of meals to an older individual. Ref. Chapter 64-E-11- Food Hygiene, F.A.C. (<http://fac.dos.state.fl.us>).

The 1800-calorie component meal pattern has been developed to reflect the current Dietary Guidelines for Americans and USDA Food Intake Pattern calorie levels for a moderately active 70+-year-old female (requirements for those programs that are not using computerized nutrient analysis). Holidays and birthday celebration meals (two or fewer meal types per calendar month) may be excluded from the component meal pattern requirement. The component meal pattern may be deficient in vitamin E, vitamin B12, and Zinc, therefore additional nutrition education for participants on the selection of foods that are good sources of these nutrients shall be provided.

# DEPARTMENT OF ELDER AFFAIRS PROGRAMS AND SERVICES HANDBOOK

## Chapter 3: Older Americans Act (OAA)

### Section III: Service Requirements

### Nutrition Program Policies

---

Items that provide the following target nutrients should be identified on the menu.

Vitamin C – must provide at least 25 mg per meal.

Vitamin A – must provide at least 233 ug at least three times per week,

**Menu Focus:** Whole grains and high fiber foods should be included as much as possible. It is recommended that fortified foods should be used to meet vitamin B12 needs. The use of nutrient dense foods, as well as fortified and enriched products, should be a priority.

**DEPARTMENT OF ELDER AFFAIRS PROGRAMS AND SERVICES HANDBOOK**

**Chapter 3: Older Americans Act (OAA)**

Section III: Service Requirements

Nutrition Program Policies

**DIETARY GUIDELINE MEAL PATTERN REQUIREMENT FOR ONE MEAL PER DAY**

<b>Food Group</b>	<b>Servings/Meal</b>	<b>Daily Dietary Guideline Recommendations</b>
Grains	2 servings: (1/2 cup (cooked) pasta or rice, 1 cups cereal, 1 slice of bread (1 ounce each)	6-ounce equivalent servings daily. Include 3-ounce equivalent of whole grain high fiber foods
Vegetable	1.7 servings: 3/4 cup cooked or 1-1/2 cups raw equivalent measure (may serve an additional fruit instead of a vegetable)	2 1/2 cups (5 servings daily). Serve a variety of vegetables, including those that are dark green, red, and orange.
Fruit	1 serving: 1/2 cup (4 ounces) or equivalent measure	1.5 cups (4 servings daily) Focus on whole fruits and include those that are deeply colored fruits such as oranges.
Dairy	1 serving: 1 cup (8 ounces) or equivalent measure	3, 1-cup equivalent servings daily. Select low-fat products
Protein Foods	1.7 serving: 2-ounce edible portion or equivalent measure	5 ounce-equivalent servings daily
Fat	1 serving: 1 teaspoon or equivalent measure is optional	Select foods lower in fat and saturated fat. Limit total fat to 30%, saturated 10% (20%)
Dessert	Optional	Select foods high in whole grains, low in fat and sugar
Optional Beverages: Water, coffee, tea, decaffeinated beverages, fruit juices.	8 ounces, minimum, per seasonal preferences	

\*Limit saturated fat, sodium, and added sugar

The Dietary Guideline Meal Pattern is based on the DRI for energy. It provides approximately 600 calories per meal. The number of servings for each food group is based on the USDA's ChooseMyPlate.gov for food groups and. These profiles represent the quantities of nutrients and other components that one can expect to obtain on average from one serving of food in each group. Serving sizes are based on the MyPlate (<http://www.choosemyplate.gov>). Although this meal pattern is based on food servings recommended in the Dietary Guidelines and Choose My Plate, it does not ensure that meals meet 1/3 of the DRI/AI and Dietary Guidelines.

DEPARTMENT OF ELDER AFFAIRS PROGRAMS AND SERVICES HANDBOOK

Chapter 3: Older Americans Act (OAA)

Section III: Service Requirements

Nutrition Program Policies

**Food Group Components and Serving Sizes:** Serving size shall meet or exceed the guidelines listed in this section. Some foods are classified in more than one food group. However, a serving of a food can only be counted in one food group within the same meal. For example, dried beans may be counted as either a meat alternate serving or as a vegetable serving, but not both in the same meal. Likewise, cottage cheese may be counted as either meat alternate serving or milk alternate serving, but not both.

- A. **Grains:** A serving of bread is generally 1 slice (1ounce); ½ cup pasta or grain product, or 1 ounce of ready-to- eat cereal. A variety of enriched and/or whole grain bread products, particularly those high in fiber are recommended. Serving sizes are:

Grains		Amount that counts as 1-ounce equivalent of grains	Common Portions and ounce equivalents
Bagels	WG*: whole wheat RG*: plain, egg	1 "mini" bagel	1 large bagel = 4-ounce equivalents
Biscuits	(baking powder/buttermilk- RG*)	1 small (2" diameter)	1 large (3" diameter) = 2-ounce equivalents
Breads	WG*: 100% whole wheat RG*: white, wheat, French	1 regular slice 1 small slice French 4 snack-size slices rye bread	2 regular slices = 2- ounce equivalents
Bulgur	Cracked wheat (WG*)	1/2 cup cooked	
Cornbread	(RG*)	1 small piece (2 ½" X 1 ¼" X 1 ¼")	1 medium piece (2 ½" X 2 ½" X 1)¼") = 2-ounce equivalents
Crackers	WG*: whole wheat, rye, RG*: saltines, snack crackers	5 whole wheat crackers 2 rye crisp breads 7 square or round crackers	
English muffin	WG*: whole wheat RG*: plain, raisin	1/2 muffin	1 muffin = 2-ounce equivalents

**DEPARTMENT OF ELDER AFFAIRS PROGRAMS AND SERVICES HANDBOOK**

**Chapter 3: Older Americans Act (OAA)**

**Section III: Service Requirements**

**Nutrition Program Policies**

Grains		Amount that counts as 1 ounce equivalent of grains	Common Portions and ounce equivalents
Muffins	WG* whole wheat RG* bran, corn, plain	1 small (2 ½ "diameter)	1 large (3 ½" diameter = 3-ounce equivalents
Oatmeal	(WG)	½ cup cooked 1 packet instant 1 ounce (1/3 cup) dry (regular or Quick)	
Pancakes	WG*: whole wheat, buckwheat RG*: buttermilk, plain	1 pancake (4 ½ "diameter) 2 small pancakes (3" diameter)	3 pancakes (4 ½ "diameter) = 3-ounce equivalents
Ready-to-eat breakfast cereal	WG* toasted oat, whole wheat flakes RG* corn flakes, puffed rice	1 cup flakes or rounds 1 ¼ cup puffed	
Rice	WG*: brown, wild RG*: enriched, white, polished	½ cup cooked 1 ounce dry	1 cup cooked = 2 ounce equivalents
Pasta- spaghetti, macaroni noodles	WG*: whole wheat RG*: enriched, durum	½ cup cooked 1 ounce dry	1 cup cooked = 2-ounce equivalents
Tortillas	WG*: whole wheat, whole grain corn RG*: flour, corn	1 small flour tortilla (6" diameter) 1 corn tortilla (6" diameter)	1 large tortilla (12" diameter) = 4-ounce equivalents

\*WG = whole grains, RG = refined grains. This is shown when products are available both in whole grain and refined grain forms. Source: ChooseMyPlate.gov.

1. Increase servings of whole grain, wheat, bran, rye bread, and cereal products, to provide adequate complex carbohydrates and fiber.
2. Limit high-fat bread and bread-alternate selections such as biscuits, quick bread, muffins, cornbread, dressings, croissants, fried hard tortillas and other high fat crackers to limit total fat as well as saturated fat.
3. Bread alternates do not include starchy vegetables such as potatoes, sweet potatoes, corn, yams, or plantains. These foods are included in the vegetable food group.

DEPARTMENT OF ELDER AFFAIRS PROGRAMS AND SERVICES HANDBOOK

Chapter 3: Older Americans Act (OAA)

Section III: Service Requirements

Nutrition Program Policies

- B. **Vegetables:** A serving of vegetable, including dried beans, peas, lentils, lima beans, potato, plantains, sweet potato, and corn is generally the following:

	Amount that counts as 1 cup of vegetables	Amount that counts as ½ cup of vegetables
<b>Dark Green Vegetables</b>		
Broccoli	1 cup chopped or florets 3 spears 5" long raw or cooked 1 cup cooked	
Spinach	1 cup cooked 2 cups raw is equivalent to 1 cup of vegetables	1 cup raw is equivalent to ½ cup of vegetables
Raw leafy greens: spinach, romaine, watercress, dark green leafy lettuce, endive, escarole	2 cups raw is equivalent to 1 cup of vegetables	1 cup raw is equivalent to ½ cup of vegetables
<b>Red and Orange Vegetables</b>		
Carrots	1 cup, strips, slices, chopped, raw, or cooked 2 medium 1 cup baby carrots (about 12)	1 medium carrots About 6 baby carrots
Tomatoes	1 large raw whole (3") 1 cup chopped, sliced, raw, canned, or cooked	1 small raw whole (2 ¼" diameter) 1 medium canned
Tomato juice	1 cup	½ cup
Sweet potato	1 large baked (2 ¼" or more diameter) 1 cup sliced or mashed, cooked	
Winter squash (acorn, butternut, hubbard)	1 cup cubed, cooked	½ acorn squash, baked = ¾ cup
<b>Beans and Peas</b>		
Dry beans and peas (such as black, garbanzo, kidney, pinto, soy bean beans, black eyed peas, or split peas)	1 cup whole or mashed, cooked	



**DEPARTMENT OF ELDER AFFAIRS PROGRAMS AND SERVICES HANDBOOK**

**Chapter 3: Older Americans Act (OAA)**

Section III: Service Requirements

Nutrition Program Policies

	Amount that counts as 1 cup of vegetables	Amount that counts as ½ cup of vegetables
<b>Starchy Vegetables</b>		
Corn, yellow, or white	1 cup 1 large ear (8" to 9" long)	1 small ear (about 6" long)
Green peas	1 cup	
White potatoes	1 cup diced, mashed 1 medium boiled or baked potato (2 ½" to 3" diameter) French fried: 20 medium to long strips (2 ½" to 4" long) (Contains added calories from solid fats.)	
<b>Other Vegetables</b>		
Cabbage, green	1 cup, chopped or shredded Raw or cooked	
Cauliflower	1 cup pieces or florets raw or cooked	
Celery	1 cup, diced or sliced, raw or cooked 2 large stalks (11" to 12" long)	1 large stalk (11" to 12" long)
Cucumbers	1 cup raw, sliced, or chopped	
Green or wax beans	1 cup cooked	
Green peppers	1 cup chopped, raw, or cooked 1 large pepper (3" diameter, 3 ¾" long)	1 small pepper
Lettuce, iceberg or head	2 cups raw, shredded, or chopped = equivalent to 1 cup of vegetables	1 cup raw, shredded, or chopped Equivalent to ½ cup of vegetables
Onions	1 cup chopped, raw, or cooked	
Summer squash or zucchini	1 cup cooked, sliced, or diced	

Source: <http://www.ChooseMyPlate.gov>

1. Fresh or frozen vegetables are preferred.
2. Vegetables as a primary ingredient in soups, stews, casseroles, or other combinations dishes should total ½ cup per serving.

DEPARTMENT OF ELDER AFFAIRS PROGRAMS AND SERVICES HANDBOOK

Chapter 3: Older Americans Act (OAA)

Section III: Service Requirements

Nutrition Program Policies

C. Fruits: A serving of fruit is generally the following:

	Amount that counts as 1 cup of fruit	Other amounts (count as ½ cup of fruit unless noted)
Apple	½ large (3.25" diameter) 1 small (2.5" diameter) 1 cup sliced or chopped, raw or cooked	½ cup sliced or chopped, raw or cooked
Applesauce	1 cup	1 snack container (4 oz.)
Banana	1 cup sliced 1 large (8" to 9" long)	1 small (less than 6" long)
Cantaloupe	1 cup diced or melon balls	1 medium wedge (1/8 of a medium melon)
Grapes	1 cup whole or cut-up 32 seedless grapes	16 seedless grapes
Grapefruit	1 medium (4" diameter) 1 cup sections	½ medium (4" diameter)
Mixed fruit (fruit cocktail)	1 cup diced or sliced, raw or canned, drained	1 snack container (4 oz.) drained = 3/8 cup
Orange	1 large (3-1/16" diameter) 1 cup sections	1 small (2-3/8" diameter)
Orange, mandarin	1 cup canned, drained	
Peach	1 large (2 ¾" diameter) 1 cup sliced, diced, raw, cooked, or canned, drained 2 halves, canned	1 small (2" diameter) 1 snack container (4 oz.) drained = 3/8 cup
Pear	1 medium pear (2.5 per lb.) 1 cup sliced, diced, raw, cooked, or canned, drained	1 snack container (4 oz.) drained = 3/8 cup
	Amount that counts as 1 cup of fruit	Other amounts (count as ½ cup of fruit unless noted)
Pineapple	1 cup chunks, sliced or crushed, raw, cooked, or canned, drained	1 snack container (4 oz.) drained = 3/8 cup
Strawberries	About 8 large berries 1 cup whole, halved, or sliced, fresh or frozen	½ cup whole, halved, or sliced
Watermelon	1 small wedge (1" thick) 1 cup diced or balls	6 melon balls
Dried fruit (raisins, prunes, apricots, etc.)	1/cup dried fruit is equivalent to 1 cup fruit. ½ cup raisins; ½ cup prunes; 1/cup dried apricots	¼ cup dried fruit is equivalent to ½ cup fruit 1 small box raisins (1.5 oz.)
100% fruit juice (orange, apple, grape, grapefruit, etc.)	1 cup	½ cup

Source: <http://www.ChooseMyPlate.gov>

DEPARTMENT OF ELDER AFFAIRS PROGRAMS AND SERVICES HANDBOOK

Chapter 3: Older Americans Act (OAA)

Section III: Service Requirements

Nutrition Program Policies

1. Frozen or canned fruit must be packed in juice or water.
2. Title III funds may only pay for full strength fruit juices. The only exception to this requirement is cranberry juice.

D. Dairy:

1. One cup low-fat, fat-free, buttermilk, low-fat chocolate milk, soy milk, or lactose-free milk fortified with Vitamins A and D should be used. Milk should be served from its original container, usually 8 ounces in size. Any deviations from this policy should be submitted in writing to the AAA's qualified dietitian for approval.
2. Low-fat or fat-free milk is recommended for the general population.
3. Powdered dry milk or evaporated milk may be served at congregate meal sites, but not for the main meal except for cultural or religious reasons. Each powdered milk or evaporated milk serving size must be equivalent to one cup of milk. Powdered milk may be used with frozen home-delivered meals and emergency meals.
4. Dairy alternates, listed in the chart below, may be provided in place of milk (for the equivalent of one cup of milk).
5. All milk containers must have a clearly labeled expiration date.
6. Policies and procedures shall be developed, and implemented, to address instances when milk is received, e.g., without an expiration date, past the expiration date, past the sell-by date, past the best-by date, or past the use by date.

Dairy Alternates
1 cup yogurt
1 ½ ounce hard cheese (Cheddar, Monterey, Provolone, Colby, American Mozzarella, Swiss, Parmesan) or 2 ounces processed cheese (American)
8 ounces tofu (processed with calcium salt)
1 ½ cup ice milk/ice-cream
1 ½ cup cottage cheese 1% fat
1 ½ cup custard

Source: <http://www.ChooseMyPlate.gov>

DEPARTMENT OF ELDER AFFAIRS PROGRAMS AND SERVICES HANDBOOK

Chapter 3: Older Americans Act (OAA)

Section III: Service Requirements

Nutrition Program Policies

**E. Protein Foods:** Two to three ounces edible portion of meat, poultry, fish, or meat alternate (or a combination of) should be provided for the lunch or supper meal. Meat serving weight is the edible portion, not including skin, bone, or coating. A one-ounce equivalent of a meat alternate includes:

	Amount that counts as 1 ounce equivalent in the Protein Foods Group	Common portions and ounce equivalents
Meats	1 ounce cooked lean beef 1 ounce cooked lean pork or ham	1 small steak (eye, round, or filet) = 3 ½ to 4-ounce equivalents 1 small lean hamburger = 2 to 3-ounce equivalents
Poultry	1-ounce cooked chicken or turkey, without skin 1 sandwich slice of turkey (4 ½" x 2 ½ x" 1/8")	1 small chicken breast half = 3-ounce equivalents ½ cornish game hen = 4-ounce equivalents
Seafood	1-ounce cooked fish or shell fish	1 can tuna, drained = 3 to 4-ounce equivalents 1 salmon steak = 4 to 6-ounce equivalents
Eggs	1 egg	3 egg whites = 2-ounce equivalents 3 egg yolks = 1-ounce equivalents
Nuts and seeds	½ ounce of nuts (12 almonds, 24 pistachios, 7 walnut halves) ½ ounce of seeds (pumpkin, sunflower, or squash seeds, hulled, roasted) 1 Tablespoon of peanut butter or almond butter	1 ounce of nuts or seeds = 2-ounce equivalents
Beans and peas	¼ cup of cooked beans (black, kidney, pinto, or white beans) ¼ cup of cooked peas (chickpeas, cowpeas, lentils, or split peas) ¼ cup of baked beans, refried beans ¼ cup (about 2 ounces) of tofu 1 oz. tempeh, cooked ¼ cup roasted soybeans 2 Tablespoons of hummus	1 cup split pea soup = 2-ounce equivalents 1 cup lentil soup = 2-ounce equivalents 1 cup bean soup = 2-ounce equivalents 1 soy or bean burger patty = 2 ounce equivalents

# DEPARTMENT OF ELDER AFFAIRS PROGRAMS AND SERVICES HANDBOOK

## Chapter 3: Older Americans Act (OAA)

### Section III: Service Requirements

### Nutrition Program Policies

---

1. A one ounce serving or equivalent portion of meat, poultry, or fish may be served in combination with other high protein foods.
2. Except to meet cultural and religious preferences and for emergency meals, avoid serving dried beans, peas or lentils, peanut butter or peanuts, and tofu for consecutive meals or on consecutive days.
3. Cooked dried beans, peas, or legumes intended as the meat alternative for any meal may not also count toward the fruit/vegetable requirement for the same meal.
4. Nuts and seeds may be used to meet no more than one-half of the meat alternative meal requirements, and must be appropriately combined with other meats/meat alternates to fulfill the requirement.
5. Cured meat products, such as ham, smoked or polish sausage, corned beef, dried beef, luncheon meats, and hot dogs are very high in sodium and the use of these type products must be limited to no more than once a week. Bacon is not considered a meat alternate, since it provides primarily fat, sodium, and few other nutrients.
6. Vegetable protein products or textured vegetable protein (VPP or TVP) are low cost alternatives and are effective in increasing the protein intake of program clients. The recommended ratio of protein product to meat is 20:80.
7. Imitation cheese (which the Food and Drug Administration defines as one not meeting nutritional equivalency requirements for the natural, non- imitation product) cannot be served as meat alternates.

DEPARTMENT OF ELDER AFFAIRS PROGRAMS AND SERVICES HANDBOOK

Chapter 3: Older Americans Act (OAA)

Section III: Service Requirements

Nutrition Program Policies

Portion Control Guide—Protein Foods	
Food Item	Required Portion Size = 3 ounces
Cottage cheese—2 ounces by weight = ¼ cup	6 ounces by weight = ¾ cup
Chicken	1 drumstick and 1 thigh or ½ breast = 3 ounces
Chili, soups	Must serve at least 1 ½ cup containing 3 ounces of meat or meat alternate to provide one meal
Cooked dried beans and peas	1 ½ cup
One egg = 1 ounce	3 eggs
Lasagna, Macaroni and Cheese, Beef or other Meat Stew, Meat Casseroles	1 ½ cup
Meat Loaf 1 slice 2" x 4" x 2" = 4 ounces	4 ounces (yield from a 20" x 12" x 2" pan = 33 servings)
Pizza 3 ¼" x 7" = 3 ounces M/MA	10 servings per 18" x 26" pan or 5 + servings from 12" x 20" pan
Roast Meats	3 ounces
Sandwiches, sliced meats/cheese Salad type fillings	3 ounces 3 ounces = ¾ cup filling
Spaghetti sauces with ground beef	1 cup
Tofu	4 ounces

DEPARTMENT OF ELDER AFFAIRS PROGRAMS AND SERVICES HANDBOOK

Chapter 3: Older Americans Act (OAA)

Section III: Service Requirements

Nutrition Program Policies

F. Prepared Fish Products:

Fish Product	Serving or Portion Size
Fish sticks, Frozen Fried Breaded, 60 percent fish	Six 1-ounce sticks = 3 ounces cooked fish
Fish sticks, Frozen Raw Breaded, 72 percent fish	Six 1-ounce sticks = 3 ounces cooked fish
Fish portions, Frozen, Fried Battered. There is no standard portion for this product. Specify 45 percent fish and require a certificate of inspection	9-ounce portion = 3 ounces cooked fish
Fish portions, Frozen, Fried Breaded	6-ounce portion = 3 ounces cooked fish
Fish portions, Frozen, Raw Breaded 75 percent fish	6-ounce portion = 3 ounces cooked fish
Fish portions, Frozen, Unbreaded	4-ounce portion = 3 ounces cooked fish

G. Additional Menu Development Considerations:

1. **Canned Soups:** Most canned soups do not contain enough meat to make a substantial contribution to the meat requirement. For example: Bean soup or Pea Soup: A 1-cup serving of soup contains ½ cup beans or peas. This is equivalent to one ounce of Meat/Meat Alternative. It would take 3 cups to provide the required 3 ounces of Meat/Meat Alternative.
2. **Hot Dogs/Frankfurters:** Red meat (beef, pork, etc.) and poultry (turkey, chicken) hot dogs that do not contain meat by products, cereals, binders, or extenders:
  - a. 1 ounce of product provides 1 ounce of cooked lean meat. Look for products labeled "All Meat", "All Beef", "All Pork", etc. If a single hotdog equals 2 ounces, it will take one and a half hot dogs to equal a 3-ounce portion.
  - b. Hot dogs containing meat by-products, cereals, binders, or extenders are not acceptable on an ounce-for-ounce basis. Product labeling will indicate the presence of any such ingredients.

# DEPARTMENT OF ELDER AFFAIRS PROGRAMS AND SERVICES HANDBOOK

## Chapter 3: Older Americans Act (OAA)

### Section III: Service Requirements

### Nutrition Program Policies

---

- c. If using hotdogs containing extenders or binders, only the cooked or lean meat portion of the product can be used toward the Meat/Meat Alternatives requirement. Obtain product information from the manufacturer if necessary.

#### H. Accompaniments, Condiments, and Product Substitutes:

1. Include traditional meal accompaniments as appropriate, e.g., condiments, spreads, and garnishes. Examples include: mustard and/or mayonnaise with a meat sandwich, tartar sauce with fish, salad dressing with tossed salad, and margarine with bread or rolls. Whenever feasible, provide reduced fat alternatives.
2. Salt substitutes shall not be provided. Sugar substitutes, pepper, herbal seasonings, lemon, vinegar, non-dairy coffee creamer, salt, and sugar may be provided, but shall not be counted as fulfilling any part of the nutritive requirements.
3. Sugar, condiments, seasonings or dressings intended for self-service use shall be provided only in individual packages or from dispensers that protect their contents.

#### I. Fat:

1. Minimize use of saturated fat in food preparation. Fats should be primarily monounsaturated and polyunsaturated vegetable oils, such as olive, peanut, corn, safflower, canola, cottonseed, and soybean oils.
2. The use of butter or fortified margarine as a spread for the bread is optional because of the emphasis on reducing fat content of the meals.

#### J. Desserts:

1. Dessert may be provided as an option to satisfy the caloric requirements or for additional nutrients. However, effort must be made to limit the amount of added sugar in the food preparation.
2. Preferred desserts include fresh, frozen, or canned fruit packed in their own juice, and low-fat products made with whole grains and/or low-fat milk.



# DEPARTMENT OF ELDER AFFAIRS PROGRAMS AND SERVICES HANDBOOK

## Chapter 3: Older Americans Act (OAA)

### Section III: Service Requirements

### Nutrition Program Policies

---

3. Pudding made with low-fat milk, low-fat ice cream, ice milk, or frozen yogurt may be served where feasible due to the increased calcium needed by the elderly.
  4. High-fat baked goods such as brownies, cakes, cobblers, cookies, and pies should be limited to once a week.
- K. Beverages:** In addition to beverages listed on the posted menu, drinking water should be available at all times. .
- L. Functional Foods:** Functional foods are foods in which the concentrations of one or more ingredients have been manipulated or modified to enhance their contribution to a healthy diet. Examples include everything from fruits, vegetables, grains and legumes, to fortified or enhanced foods. Nutrition programs are encouraged to use functional foods in menus whenever possible. Additional information regarding functional foods can be found at <http://www.eatright.org>.
- M. Dietary Supplements:** Dietary supplements encompass a wide range of products, including but not limited to vitamins, minerals, amino acids, and herbs. Although some older adults may need dietary supplements for health enhancement and/or to assist in meeting daily nutrient needs, they cannot be included in nutrition program meals.
- N. Modified Diets:** Modified or therapeutic medical diets may be provided as required by the client's special needs and medical condition.
1. **Documentation:** A written or documented verbal order must be on file for everyone receiving a modified diet, and the order should be reviewed annually with the client's healthcare provider.

# DEPARTMENT OF ELDER AFFAIRS PROGRAMS AND SERVICES HANDBOOK

## Chapter 3: Older Americans Act (OAA)

### Section III: Service Requirements

### Nutrition Program Policies

2. **Therapeutic Diet:** A therapeutic diet is an individualized diet prescription written by a medical professional that defines the client's daily intake for specific nutrients, i.e., an insulin-controlled diabetic diet would specify grams of carbohydrates, protein, fat and calories. For each client requiring a therapeutic diet, it is the responsibility of the qualified dietitian to develop an individual diet plan that provides the exact prescription of the prescribing medical professional and is adapted to the individual's food preferences as much as possible. Therapeutic diets require in-depth planning, counseling, and on-going supervision by a qualified dietitian.
3. **Modified/Therapeutic Menu:** Modified or therapeutic menus must be planned and prepared under the supervision of a Qualified Dietitian.
4. **Malpractice Insurance:** It is recommended that any dietitian providing therapeutic diet instruction be covered by malpractice insurance.
5. **Manual of Medical Nutritional Therapy:** A current Florida Manual of Medical Nutritional Therapy must be used as the basis for therapeutic or modified menu planning.
6. **Feasibility/Appropriateness of Modified/Therapeutic Diet:** In determining feasibility and appropriateness, the provider must determine whether:
  - a. There are sufficient numbers of persons needing special menus to make their provision practical.
  - b. The food and skills necessary to prepare the special menus are available in the AAA.
7. **Texture Modified Meals:** Modifying food texture and consistency may help older adults with chewing and swallowing problems. Chopping, grinding, pureeing, or blending foods are common ways to modify food textures. Texture modified food has the same nutritive value of solid foods and can be just as tasty and appealing. Serving sizes should account for any dilution to the food item during the preparation process. Thickened liquids are often required for individuals with dysphagia. The provision of such foods should be planned and prepared under the advice of a qualified dietitian.
8. **Adaptive Equipment:** When feasible and appropriate, reasonable attempts will be made to provide appropriate food containers and utensils for clients with disabilities.

# DEPARTMENT OF ELDER AFFAIRS PROGRAMS AND SERVICES HANDBOOK

## Chapter 3: Older Americans Act (OAA)

### Section III: Service Requirements

### Nutrition Program Policies

---

- O. Emergency Meals:** Nutrition programs are required to develop and have available written plans for continuing services for congregate and home delivered meals during weather-related or other emergencies including food procurement. Programs may offer shelf- stable meals to clients for later use. In accordance with NOI 020520-1-I-SWCBS, Emergency Home Delivered Meals (EHDM) must be reported in CIRTS with the aggregate number of meals received by the Nutrition Provider (after receipt).

Client specific information shall be maintained by the Nutrition Provider for audit purposes. This information must include the following:

- Client Name
- Client Signature
- Client ID Number
- Date of meal received by client

In the event there are no emergencies requiring the distribution of EHDM, Nutrition Providers are responsible for having a distribution plan for these meals.

The guidelines for shelf stable meals are:

9. Nutrient content of the meal must meet all requirements of the program and be approved by the AAA or nutrition program qualified dietitian.
10. Only top-grade, non-perishable foods in intact packages shall be included.
11. Cans are to be easy open, with pull tabs whenever possible.
12. All individual foods packages are to be labeled with expiration dates. All foods must be shelf stable. (Note: Meals with a multiple year shelf life, if stored properly, can be retained from one year to another and may help contain costs.)
13. Fruit and vegetable juices are to be 100 percent pure juices.
14. Dried fruit must be packed in an airtight container.
15. When applicable, easy-to-read preparation instructions should be included.

# DEPARTMENT OF ELDER AFFAIRS PROGRAMS AND SERVICES HANDBOOK

## Chapter 3: Older Americans Act (OAA)

### Section III: Service Requirements

### Nutrition Program Policies

---

- O. Holiday Meals:** Nutrition programs are required to develop and have available written procedures that address congregate meal site holiday closures including, but not limited to, the following items:
1. **Holiday closing schedule** - The State of Florida recognizes the following holidays for employees: New Year's Day, Martin Luther King, Jr. Day, Memorial Day, Independence Day, Labor Day, Veterans Day, Thanksgiving Day, Friday after Thanksgiving Day, and Christmas Day. Providers must receive prior written authorization from the AAA for any additional planned closing dates. Also, providers must ensure that planned holiday closings do not result in the closure of a congregate meal site for more than four (4) consecutive day meal service days, which may or may not include weekend days.,
  2. **Requirements for provision of meals** - The provision of congregate services during site closures must be addressed in the AAA/provider contract. Providers must meet all requirements of the program and be approved by the AAA or nutrition program qualified dietitian.
  3. **Reporting of meals** - Nutrition programs must meet all requirements for reporting of service units

# DEPARTMENT OF ELDER AFFAIRS PROGRAMS AND SERVICES HANDBOOK

## Chapter 3: Older Americans Act (OAA)

### Section III: Service Requirements

### Nutrition Program Policies

---

#### **FOOD PURCHASING/PREPARATION STANDARDS:**

##### **Food Purchasing and Preparation Standards:**

- A. Food Purchasing:** All food purchasing shall be transacted in accordance with DOEA policies and procedures, F.A.C. 64E-11 (Food Hygiene code), state, and federal regulations and food service contract provisions.
- B. Quality, Sanitation, and Safety:** Nutrition programs shall purchase food from sources that comply with all federal, state, and local laws relating to food quality, labeling, sanitation, and safety. Food shall be safe for human consumption, sound and free of spoilage, filth or contamination. Food from unlabeled, rusty, leaking, broken containers or cans with side seam dents, rim dents, or swells shall not be used.
1. Food in hermetically sealed containers shall be processed in an establishment operating under appropriate regulatory authority.
  2. All milk products used and served must be pasteurized. Fluid milk shall meet Grade A quality standards, as established by law.
  3. All meats, poultry, and shellfish shall be obtained from a source that is licensed under a state or federal regulatory program.
  4. Only clean eggs with shells intact and without cracks or checks, pasteurized liquid, frozen, or dry eggs or pasteurized dry egg products shall be used except for commercially prepared and packaged peeled hard-boiled eggs. Pasteurized liquid, frozen, or dry eggs or egg products shall be substituted for shell eggs in the preparation of recipes calling for uncooked eggs, such as Caesar salad, hollandaise or béarnaise sauce, noncommercial mayonnaise, eggnog, ice cream, and egg fortified beverages.
  5. All ready-to-eat, or drink, foods shall have an expiration date, use-by date, sell-by date, or best-by date. All food and drinks must be received prior to the expiration date, use-by date, sell-by date, and/or best-by date.
- C. Commercial Processors of Food:** All foods the provider purchases and uses in a nutrition program for the elderly must meet standards of quality for sanitation and safety applying to commercially processed foods.

# DEPARTMENT OF ELDER AFFAIRS PROGRAMS AND SERVICES HANDBOOK

## Chapter 3: Older Americans Act (OAA)

### Section III: Service Requirements

### Nutrition Program Policies

- D. Use of Donated Food:** Nutrition programs may use contributed and discounted foods only if they meet the same standards of quality, sanitation, and safety as apply to foods purchased from commercial sources. Acceptable items include:
1. Fresh fruits and vegetables received clean and in good condition; and
  2. Food collected from a food bank, which can be prepared and served before the expiration date, use-by date, sell-by date, or best-by date.
- E. Unacceptable Food Items:** In accordance with the Florida Food Code, unacceptable items include:
1. Food that has passed its expiration date, use-by date, sell-by date, or best-by date;
  2. Home canned or preserved foods;
  3. Food cooked or prepared in an individual home;
  4. Prepackaged unpasteurized juice (including unpasteurized apple cider);
  5. Any road-kill;
  6. Wild game donated by hunters; and
  7. Fresh or frozen fish donated by sportsmen.
- F. Frozen Foods:** Foods, which are frozen for later consumption by clients, must meet applicable local, state, and federal standards. Equipment and methods for freezing must also meet these standards.
- G. Group Food Purchasing:** Providers are encouraged to participate in group food purchasing or regional or local power buying coalitions provided this method can efficiently and responsibly meet the cultural and/or ethnic culinary needs of congregate and home-delivered meal participants.

# DEPARTMENT OF ELDER AFFAIRS PROGRAMS AND SERVICES HANDBOOK

## Chapter 3: Older Americans Act (OAA)

### Section III: Service Requirements

### Nutrition Program Policies

**Meal Cost Analysis:** Calculation of the full cost of a meal is an essential food service management practice. This information is important for determining a suggested donation per meal and for informing clients of the full cost of the meal.

**Meal Cost Calculation:** Each program that prepares its own meals shall calculate the component cost of meals provided per the following categories:

- A. **Raw food:** All costs of acquiring foodstuffs to be used in the program.
- B. **Labor:**
  - 1. **Food service operation:** All expenditures for salaries and wages, including valuation of volunteer hours for personnel involved in food preparation, cooking, delivery, serving, and cleaning of dining centers, equipment, and kitchens.
  - 2. **Project management:** All expenditures for salaries and wages, including valuation of volunteer hours for non-food service operations of the program.
- C. **Equipment:** All expenditures for purchase and maintenance of items with a useful life of more than one year or with an acquisition cost of greater than \$1,000.
- D. **Supplies:** All expenditures for items with a useful life or less than one year and an acquisition cost of less than \$1,000.
- E. **Utilities:** All expenditures for gas, electricity, water, sewer, waste disposal, etc.
- F. **Other:** Expenditures for all other items that do not belong in any of the above categories (e.g., rent, insurance, fuel for vehicles) to be identified and itemized.

# DEPARTMENT OF ELDER AFFAIRS PROGRAMS AND SERVICES HANDBOOK

## Chapter 3: Older Americans Act (OAA)

### Section III: Service Requirements

### Nutrition Program Policies

---

#### **FOOD PREPARATION AND SAFETY STANDARDS:**

- A. Regulations:** In all phases of the food service operation (storage, preparation, service, and delivery of meals), nutrition programs shall adhere to the state and local fire, health, sanitation, and safety regulations applicable to the types of food preparation and meal-delivery systems used by the program. State regulations to the hygienic preparation and serving of food are stated in the Chapter 64E-11, Food Hygiene, F.A.C. (<http://fac.dos.state.fl.us/>). F.A.C. 64E-11 is referenced as the guidelines for all food handling referenced in the "Food Preparation and Safety Standards" section.

If applicable, the current food permits and/or inspection report, issued by the Department of Health or the Department of Business and Professional Regulation shall be posted or on file.

- B. Sanitation Program:** All Title III central kitchens and vendors must maintain a written, formal sanitation program that meets or exceeds the minimum requirements of state, federal, municipal, or other agencies authorized to inspect or accredit the food service operation.
- C. Food Handling, Preparation and Service:** All staff working in the preparation of food must be under the supervision of a Certified Food Protection Manager (see Planning for Nutrition Services, Part C.) Food shall be prepared, plated, and transported with the least possible manual contact, with suitable utensils, and on surfaces that, prior to use, have been cleaned, rinsed, and sanitized to prevent cross contamination.



# DEPARTMENT OF ELDER AFFAIRS PROGRAMS AND SERVICES HANDBOOK

## Chapter 3: Older Americans Act (OAA)

### Section III: Service Requirements

### Nutrition Program Policies

- D. Cleaning and Sanitizing:** Effective procedures for cleaning and sanitizing dishes, equipment, food contact surfaces, work areas, serving and dining areas shall be written, posted or readily available, and followed (refer to 64E-11, FAC.)
- E. Safety:** Material Safety Data Sheets (MSDS) must be readily available on all chemicals used by the nutrition program. Employees must be informed about potentially dangerous chemicals used in the workplace and how to safely use them (<http://www.msdssearch.com>). Toxic materials, such as cleaners and sanitizers, shall be maintained in the original container or transferred to a clearly labeled appropriate container. Toxic materials must be stored separate from food, food equipment or single-service articles. Sanitizers, detergents, or other cleaning compounds shall be stored separately from insecticides, rodenticides, and other poisonous or toxic materials using methods such as different storage cabinets or separate areas of a room. Ref. Occupation Safety & Health Administration (OSHA) 1910.1200(g).
- F. Quality and Quantity of Meals:** Tested standardized quantity recipes, adjusted to yield the number of servings needed, must be used to achieve the consistent and desirable quality and quantity of all meals.
- G. Food Palatability:** All foods must be prepared and served in a manner to preserve optimum flavor and appearance, while retaining nutrients and food value.
- H. Portion Control:** Nutrition programs must use standardized portion control procedures and equipment to ensure that each served meal is uniform and to reduce plate waste.
- I. Potentially Hazardous Foods:** Potentially hazardous food is any food or food ingredient, natural or synthetic, which requires temperature control because it is in a form capable of supporting the rapid and progressive growth of infectious toxigenic microorganisms. Potentially hazardous foods that may cause foodborne illness include, but are not limited to:
1. Any food that consists in whole or in part of milk or milk products, shell eggs, beef, poultry, pork, lamb, fish, shellfish, tofu, soy protein foods, cooked rice, beans, potatoes, or other heat-treated plant foods;

# DEPARTMENT OF ELDER AFFAIRS PROGRAMS AND SERVICES HANDBOOK

## Chapter 3: Older Americans Act (OAA)

### Section III: Service Requirements

### Nutrition Program Policies

2. Chicken salad, , pasta salad, , , tuna salad, potato salad, and other mixed foods containing potentially hazardous ingredients or dressings;
3. Raw seed sprouts;
4. Cut fruit; and
5. Garlic-in-oil mixtures that are not acidified or otherwise modified at a food processing plant in a way that results in mixtures that do not support growth as specified in the definition.

#### J. Temperature and Time Control Requirements:

##### 1. Cooling temperature requirements:

- a. Potentially hazardous foods requiring refrigeration after preparation, such as, chicken salad, , tuna salad, potato salad, or other mixed foods containing potentially hazardous ingredients or dressings shall be prepared from chilled products with a minimum of manual contact and shall be rapidly cooled to an internal temperature of 41° F. or below within four hours.
- b. Shell eggs do not apply if placed in a refrigerated unit immediately upon delivery.

##### 2. Internal cooking temperature requirements:

- a. Eggs, fish, meat, and pork must meet an internal temperature of 145° F.
- b. Comminuted food (chopped, flaked, ground, or minced such as; ground beef, sausage, and gyros) must meet an internal temperature of 155° F.
- c. Stuffing, stuffed meat, or poultry must meet an internal temperature of 165° F.
- d. Fresh, frozen, or canned fruits and vegetables that are cooked for hot- holding must meet an internal temperature of 140° F for 15 seconds.

# DEPARTMENT OF ELDER AFFAIRS PROGRAMS AND SERVICES HANDBOOK

## Chapter 3: Older Americans Act (OAA)

### Section III: Service Requirements

### Nutrition Program Policies

- e. Microwave cooking temperatures for raw animal foods must be to a temperature of 165° F. in all parts of the food, allowed to stand for 2 minutes after cooking, covered to retain heat and stirred or rotated during cooking for even distribution of heat.
- f. Potentially hazardous foods that have been cooked and then refrigerated, or frozen, shall be reheated rapidly to a minimum of 165° F. for 15 seconds throughout all parts of the food before being served or placed in hot food storage equipment.

#### **K. Holding temperature requirements:**

- 1. Hot-holding temperatures for all hot foods are 140° F. or above.
- 2. Cold-holding temperatures for all cold foods are 41° F. or below.
- 3. Frozen foods shall be maintained frozen solid.

#### **M. Meal Temperature Documentation Requirements:** Temperature checks shall be taken, and documented, daily. Documentation shall be maintained for at least two years. Documentation must include at a minimum:

- 1. Time menu items delivered;
- 2. Each menu item and serving size;
- 3. Temperature(s) of each potentially hazardous menu items must be taken:
  - a. When the food is received by the nutrition site;
  - b. If there is more than 30 minutes between when the food is received at the meal site and when it is served, then a time and a temperature of each food item must be documented again at the time the meal is served; and
  - c. If a nutrition provider prepares the meal on site, then temperature must be taken and recorded when the food is leaving the production area.

Food grade probe-type thermometers must be used; other thermometers such as infrared thermometers, which do not insert into food cannot be used to take food temperatures. Thermometers must be correctly calibrated at least weekly, to ensure accuracy. Thermometers must be clean and sanitized between uses.

# DEPARTMENT OF ELDER AFFAIRS PROGRAMS AND SERVICES HANDBOOK

## Chapter 3: Older Americans Act (OAA)

### Section III: Service Requirements

### Nutrition Program Policies

#### N. Hazard Analysis Critical Control Point:

1. Hazard Analysis Critical Control Point (HACCP) is a proactive, comprehensive, science-based food safety system that allows operators to continuously monitor their establishments and reduce the risk of foodborne illness. The Florida Administrative Code does not currently require HACCP plans; however, nutrition programs that prepare their meals are encouraged to incorporate them into their operations to improve food safety at all levels of food service.
2. A HACCP Plan involves seven principles:
  - a. **Analyze hazards:** Potential hazards associated with a food, and measures to control those hazards, are identified. The hazard could be biological (i.e. microbe,) chemical (i.e. toxin,) or physical (i.e. ground glass or metal fragments).
  - b. **Identify critical control points:** These are points in a food's production at which the potential hazard can be controlled or eliminated from its raw state, through processing and shipping, to consumption by the client. Examples include cooking, cooling, packaging, and metal detection.
  - c. **Establish preventive measures with critical limits, for each control point:** For example, for a cooked food, this might include setting the minimum cooking temperature and time required to ensure the elimination of any harmful microbes.
  - d. **Establish procedures to monitor the critical control points:** Such procedures might include determining how and by whom cooking time and temperature should be monitored.
  - e. **Establish corrective actions** to be taken when monitoring shows that a critical limit has not been met. For example, reprocessing or disposing of food if the minimum cooking temperature is not met.
  - f. **Establish procedures to verify that the system is working properly:** For example, testing time and temperature recording devices to verify that a cooking unit is working properly.

# DEPARTMENT OF ELDER AFFAIRS PROGRAMS AND SERVICES HANDBOOK

## Chapter 3: Older Americans Act (OAA)

### Section III: Service Requirements

### Nutrition Program Policies

- g. Establish effective record keeping documenting the HACCP system:** This would include records of hazards and their control methods, the monitoring of safety requirements, and action taken to correct potential problems. Each of these principles must be backed by sound scientific knowledge. For example, published microbiological studies on time and temperature factors for controlling foodborne pathogens.

**NOTE:** A HACCP principles guide for operators of food service is available at <http://www.fda.gov/Food/GuidanceRegulation/HACCP/ucm2006801.htm>

- O. Food Service Employees/Volunteers:** All food preparation staff must work under the supervision of a Certified Food Protection Manager who ensures the application of hygienic techniques and practices in food preparation and service. A Certified Food Protection Manager is an individual who has successfully completed a Department of Health approved food safety and sanitation course and maintains a current certificate of completion.
- 1. Employee Orientation:** Any new staff or volunteer having contact with food service must have a general orientation to safe food handling and sanitation practices.
  - 2. Employee Health and Hygiene:** Employees can transmit foodborne illnesses through cross contamination of food, improper food temperature control, and food handlers' personal hygiene and medical condition.

All food handlers must adhere to 64E-11 FAC along with the standards set forth in the Nutrition Program Compliance Review form.

**P. Suspected Foodborne Illness Outbreak Procedure:**

- 1.** Nutrition programs should have a plan in place to respond to a suspected foodborne illness outbreak.

# DEPARTMENT OF ELDER AFFAIRS PROGRAMS AND SERVICES HANDBOOK

## Chapter 3: Older Americans Act (OAA)

### Section III: Service Requirements

### Nutrition Program Policies

2. Employees or volunteers shall direct all calls from clients claiming they became sick from a congregate or home delivered meal they consumed to the manager or person in charge immediately. An incident report collecting the following information shall be completed:
  - a. What is the name, address, and telephone number of person calling, including date and time of call?
  - b. Who became ill and what were the symptoms?
  - c. Was the illness diagnosed by a healthcare provider? Obtain healthcare provider's name if diagnosed.
  - d. What food and/or drinks were consumed?
  - e. What was the location, date, and time the food was consumed?
  - f. What is the name of person who served the food?
3. Evaluate the information promptly. Consider that a foodborne disease outbreak may have occurred when two or more persons experience a similar illness, usually gastrointestinal, after eating a common food.
4. If a foodborne outbreak is suspected, the following contacts shall be notified immediately:
  - a. Area Agency on Aging;
  - b. Local health department;
  - c. Department of Elder Affairs;
  - d. Food vendor (if applicable); and
  - e. Attorney and insurance agent.

# DEPARTMENT OF ELDER AFFAIRS PROGRAMS AND SERVICES HANDBOOK

## Chapter 3: Older Americans Act (OAA)

### Section III: Service Requirements

### Nutrition Program Policies

#### **FOOD SERVICE CONTRACT PROVISIONS:**

##### **Food Service Contract Requirements:**

- A. **Food Service Contracts:** Food service contracts are defined as contracts for the purchase of meals or portions of meals or for food preparation.
- B. **Adherence to Standards:** All service providers must adhere to all standards set forth herein and incorporate the "Menu Planning, Development Review, and Approval Requirements" section of this handbook.
- C. **Competitive Bidding Time Frame:** Competitive bidding for food service vendor contracts must be conducted a minimum of every six years.
- D. Nutrition Programs are encouraged to ensure that their food service vendors use production kitchens located within the state of Florida. Any nutrition provider wanting to do business with a vendor that maintains meal preparation kitchens outside the state of Florida must seek prior approval from DOEA and ensure the production kitchen follows the Food and Drug Administration and the United States Department of Agriculture and any other applicable federal or state regulation.
- E. Preference may be given to vendors requiring the least amount of delivery time needed to facilitate meal quality. Multiple vendors' contracts may be required to ensure meal sites offer culturally appropriate meals with limited meal delivery transit time.
- F. **Bid Specifications and Terms:** Food service vendor contracts should include, but not be limited to, the following specifications:
  1. **Delivery:**
    - a. **Transportation:** Trucks and vans capable of holding food at the required temperature and are clean and well maintained;
    - b. **Delivery sites:** Addresses and location of dining centers to be served;

# DEPARTMENT OF ELDER AFFAIRS PROGRAMS AND SERVICES HANDBOOK

## Chapter 3: Older Americans Act (OAA)

### Section III: Service Requirements

### Nutrition Program Policies

---

- c. **Delivery Schedule:**
    - i. Number of days per week and specific days of required service;
    - ii. Number of holidays and days when meals are not to be served;
    - iii. Number of meals served with a time schedule for ordering additional or cancellation of daily meal counts; and
    - iv. Delivery schedules with a description of the time span between food packaging and delivery (to the extent possible not to exceed 4 hours). Preference should be given to the vendor that provides the best quality and the shortest time span between packaging and delivery of hot food.
  - d. **Containers:**
    - i. Food packaging style for transport;
    - ii. Food transport equipment specifications; and
    - iii. Responsibility for purchase and maintenance of the food transport equipment.
2. **Menus:** Menus shall be written per DOEA standards specified in this handbook and include the following:
- a. Name and title of person who completed the menus;
  - b. Name and title of person who approved the menu;
  - c. Statement indicating which menu development methodology the vendor is utilizing:
    - i. Menus must indicate serving sizes of all components; and



# DEPARTMENT OF ELDER AFFAIRS PROGRAMS AND SERVICES HANDBOOK

## Chapter 3: Older Americans Act (OAA)

### Section III: Service Requirements

### Nutrition Program Policies

- d. Requirement that menus must be submitted to the project director at least six calendar weeks in advance of implementation. Nutrition Program's qualified dietitian must approve menus.
  - e. Provision for evaluation of menu acceptability and menu revisions; and
  - f. Requirement to obtain prior approval by the nutrition service provider's qualified dietitian for all menu substitutions outside of a pre-approved menu substitution list.
3. **Food Safety and Sanitation:** The following food safety and sanitation requirements must be addressed in the vendor contract:
- a. Requirement for documentation of a food safety management program within the facility that meets or exceeds the minimum requirements of federal, state, municipal, or other agencies authorized to inspect or accredit the food service operation;
  - b. Requirement to provide documentation of the three most recent food preparation inspections conducted by the state regulatory authority;
  - c. Requirement to provide a written plan of correction for any high priority or significant findings on sanitation inspections;

# DEPARTMENT OF ELDER AFFAIRS PROGRAMS AND SERVICES HANDBOOK

## Chapter 3: Older Americans Act (OAA)

### Section III: Service Requirements

### Nutrition Program Policies

- d. Requirement to notify the Nutrition Provider immediately for any closures or Administrative Complaints regarding food safety; and notify the Nutrition Provider within 24 hours of any sanitation inspections;
  - e. Description of vendors' delivery standards and sanitation that includes holding temperatures for transporting and serving food; and
  - f. Right of the nutrition program, AAA, or Department staff to inspect the food preparation and storage areas.
4. **Food Service:** The following food service topics must be included:
- a. Number of meals and unit price for meals and other food served;
  - b. Breakdown of bid price for the raw food cost, labor, transportation, equipment, paper and plastic supplies, profit and other costs;
  - c. Food provided, including:
    - i. Entrée;
    - ii. Grain;
    - iii. Vegetable;
    - iv. Fruit;
    - v. Milk;
    - vi. Juice;
    - vii. Salad;
    - viii. Beverage;
    - ix. Cream/substitution;
    - x. Condiments; and
    - xi. Butter/margarine.
  - d. A provision stating that the nutrition program is not required to pay for food not meeting the proper specifications.

# DEPARTMENT OF ELDER AFFAIRS PROGRAMS AND SERVICES HANDBOOK

## Chapter 3: Older Americans Act (OAA)

### Section III: Service Requirements

### Nutrition Program Policies

- e. A provision stating that the nutrition program will procure food from other sources at the vendor's additional expense, if the vendor: fails to deliver a meal or any portion of a meal, delivers food that was spoiled, out of date, or otherwise inedible.
- f. A provision addressing supply of substitution food items to be kept at the meal site in case a substitution is necessary. If a supply of substitution items is kept on site, then a system must be in place to ensure all food items are used prior to the product's expiration date, use-by date, sell-by date, or best-by date.
- g. Provision for napkins, table covering, home-delivered meal containers, paper towels, and table service, including plates, cups, glasses, and silverware. The vendor shall provide specifications of the disposable supplies (each vendor shall be requested to provide samples of proposed packaging with the bid).
- h. Administration:
  - Schedule and method of payment to the food vendor;
  - Sales tax exemption;
  - Responsibility for product liability insurance and property damage;
  - Bonding;
  - Requirement that the vendor's financial records are open for audit purposes;
  - AAA approval; and
  - Binding time of the contract, as well as the termination process agreed upon by both parties.

**NOTE:** All food service contracts with profit-making organizations shall have prior approval from the AAA.

# Attachment - C

Attachment-C

253

# City of Miami Springs Senior Center

## MENU SUBSTITUTION POLICY & PROCEDURES

**POLICY:** All meals served must meet the Dietary Guidelines for Americans of 1/3 RDA and comply with the requirements for Age 70+ female Dietary Reference Intake/Adequate Intakes (DRI's/AIs). The menu substitution items will be in accord with guidelines documented in section 4-9, section E, Nutrition program polices in the Department of Elder Affairs program and services manual.

**PURPOSE:** To outline the procedures necessary to ensure that all meals served comply with DOEA nutritional guidelines.

### PROCEDURES:

1. Menu substitutions must be from the same food group and must provide an equivalent nutritional value.
2. The *Menu Substitution Guidelines* (revised 9/2014), the pre-approved substitution list developed by the AAA's dietitian, is to be used in emergencies when contracted menu items are not available.
3. In the event that a menu item is not available and must be substituted, the pre-approved substitution list developed by the AAA's dietitian, *Substitution Guidelines* (revised 9/2014), will be used by the caterer to choose a replacement for that food item on the menu. The substitution will be documented on the CMS Senior Center's Substitution Log.
  - If the replacement food item is not on the pre-approved substitution list, the caterer or the CMS Senior Center must obtain approval from a licensed dietician prior to making a substitution. This action must be documented on the Substitution Log.
    - If the dietitian is not available, the CMS Senior Center's Project Director or caterer's staff will make the best choice available using the *Substitution Guidelines* and document this action on the Substitution Log.
5. Documentation of all menu substitutions will be kept on file for monitoring purposes. The documentation will include the date of substitution, the original menu item, the substitution made, the reason for the substitution and the signature of the employee authorizing the substitution. Copies of the Substitution Logs must be kept on file for at least two years and submitted quarterly to the Alliance's Contract Manager for review.
6. To finalize this procedure, a CMS Senior Center's staff member will document completion of any corrective action on the Substitution Log.
7. The volume of substitutions made by the caterer must be justified by the reasons provided. Substitutions should be kept to a minimal, with less than 5 per month.

## MENU SUBSTITUTION GUIDELINES:

The Dietary Guideline Meal pattern for one meal should consist of:

Food Group	Servings/Meal
Bread/Grains	1.7 servings: (1 cup (cooked) pasta or rice, 2 cups cereal, 2 slices bread (1 ounce each))
Vegetable	1.5 servings: 3/4 cup cooked or 1-1/2 cups raw equivalent measure (may serve an additional fruit instead of a vegetable)
Fruit	1 serving: 1/2 cup (4 ounces) or equivalent measure
Milk or Alternate	1 serving: 1 cup (8 ounces) or equivalent measure
Meat or Alternate	1.7 serving: 2 ounce edible portion or equivalent measure
Fat	1 serving: 1 teaspoon or equivalent measure is optional
Dessert	Optional
Optional Beverages: Water, coffee, tea, decaffeinated beverages, fruit juices.	8 ounces, minimum, according to seasonal preferences

**Avoid substitutions, but in case of emergency**, here are guidelines if menu items are not available. Consult your RD for further clarification. Choose foods in like Food Groups – substitute a vegetable for a vegetable, a fruit for a fruit, a meat for a meat, etc. Menu substitutions should be minimal, but are allowed under the following conditions:

1. Menu substitutions must be from the same food group and sub-group and provide equivalent nutritional value. For example, a fruit high in Vitamin C must be substituted with another fruit high in Vitamin C; a dark green vegetable should be substituted with another dark green vegetable.
2. All substitutions must be documented. Keep documentation on file and on-site for monitoring purposes. The Substitution Log must include the date of substitution, the original menu item, the substitution made, the reason for the substitution and the signature of the employee noting the substitution. Finally, the volume and frequency of substitutions must be justified by the reasons provided and must occur less than 5 times/month.

**Below is a pre-approved list of foods that can be used to determine appropriate food substitutions in the event of an emergency. If a food is not on the list, or if clarification is required, the program's Registered Dietitian should be contacted. If the Registered Dietitian is not available, the substitution must be properly documented on the Substitution Log.**

Find the menu item and replace with an item from the following sub-group in which it is found:

---

## **Vegetables:**

---

### **Dark Green:**

Broccoli  
Brussel sprouts  
Collard Greens  
Kale  
Spinach  
Turnip greens

### **Starchy:**

Baked, boiled potatoes  
Corn  
Peas  
Mashed Potatoes  
Yucca  
Plantains

### **Orange:**

Carrots  
Orange squashes  
Pumpkin  
Sweet potatoes

### **Legumes:**

Black Beans  
Blackeye Peas  
Garbanzo Beans  
Lentils  
Lima Beans  
Navy Beans  
Pigeon Peas  
Pinto Beans  
Red Beans  
Split Peas

### **Other Vegetables:**

Broccoli  
Cabbage  
Cauliflower  
Green Beans  
Mixed vegetables  
Okra  
Peppers (Sweet)  
Tomato juice, paste or puree  
Tomatoes  
Turnips  
Yellow Squash  
Zucchini

---

## **Fruits:**

---

### **Citrus/Vit C Sources:**

Apple Juice (*enriched with Vitamin C*)  
Cantaloupe  
Citrus fruit cup  
Grape Juice (*enriched with Vitamin C*)  
Grapefruit  
Grapefruit juice  
Guava  
Oranges  
Orange juice (100%)  
Nectarines  
Papaya  
Plum  
Prunes  
Strawberries  
Tangerines  
Tropical fruit cup

### **Vitamin A Sources:**

Apricots (fresh or water packed)  
Cantaloupe  
Cherries (Sour canned)  
Mango  
Peaches (canned)  
Plums, purple (canned)  
Red or pink grapefruit  
Watermelon

### **Other Fruits:**

Apples (fresh or canned)  
Applesauce (unsweetened)  
Banana  
Casaba  
Fruit Cocktail (canned unsweetened)  
Peach (fresh)  
Pears (canned or fresh)  
Pineapple  
Plum (fresh)  
Prunes  
Raspberries  
Raisins  
10% fruit juice

---

**Grains:**

---

**Whole Grain:**

Barley  
Brown Rice  
Kasha  
Oatmeal  
Whole Wheat Bread  
Whole Wheat Pasta  
Whole Grain Cereals (Cereal with first ingredient a "whole" grain)

**Non-Whole Grains:**

(Cereal with first ingredient an "enriched" grain)  
Egg Noodles (all shapes)  
Enriched Cereal Bars  
White or wheat breads  
White pasta (all shapes)  
White rice  
White or honey wheat bread rolls  
Cuban bread  
French bread

---

**Meat and Meat Alternates:** (See DOE Manual for other choices)

---

When substituting meats, the following guidelines should be taken into consideration:

1. U.S.D.A. Dietary Guidelines should be followed -- choose leaner meats and avoid frying.
2. Avoid highly processed meats such as hot dogs, salami, bologna, cured meats or other high sodium meats.
3. In the event of a hurricane where a cold meal/sandwich is provided, you may use 3 oz. deli style ham, turkey, chicken, roast beef, and any cheese.

---

**Milk**

---

No dairy substitutions allowed.

---





**CITY OF MIAMI SPRINGS  
REQUEST FOR PROPOSALS NO. 01-20/21**

**ATTACHMENT D**

**CITY OF MIAMI SPRINGS ADULT COMMUNITY CENTER  
OLDER AMERICANS ACT CONTRACT REPORT CALENDAR  
ADVANCE BASIS CONTRACT**

<b>Report No.</b>	<b>Service Month</b>	<b>Invoice Due Date<sup>2</sup></b>
1	October	November 5 <sup>th</sup>
2	November	December 5 <sup>th</sup>
3	December	January 5 <sup>th</sup>
4	January	February 5 <sup>th</sup>
5	February	March 5 <sup>th</sup>
6	March	April 5 <sup>th</sup>
7	April	May 5 <sup>th</sup>
8	May	June 5 <sup>th</sup>
9	June	July 5 <sup>th</sup>
10	July	August 5 <sup>th</sup>
11	August	September 5 <sup>th</sup>
12	September	October 5 <sup>th</sup>

<sup>2</sup> Note: Invoices due on the 5<sup>th</sup> day of each month for the term of the contract.

# Paper Goods

Attachment-D

260

6050 ALUMINUM PAN

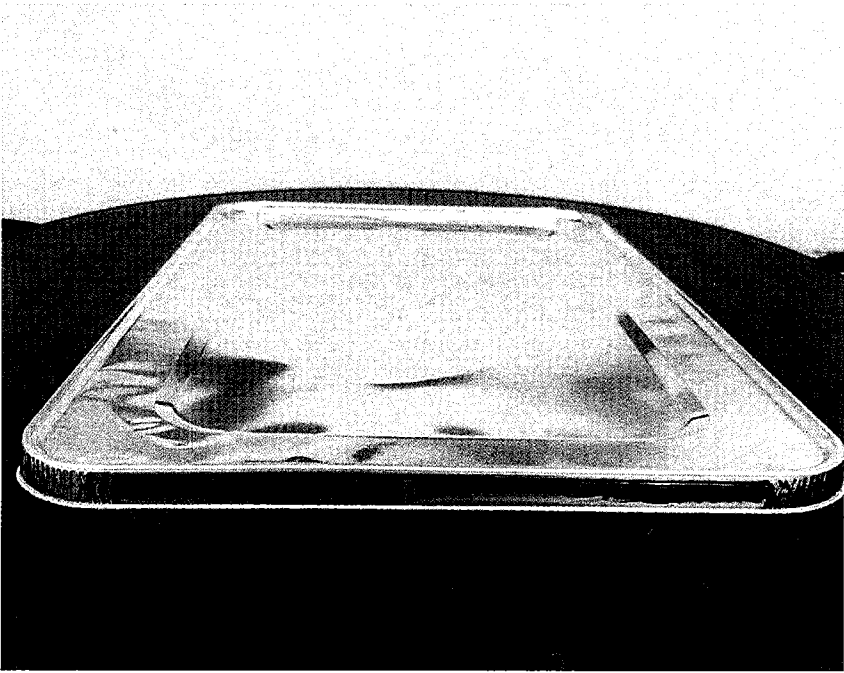
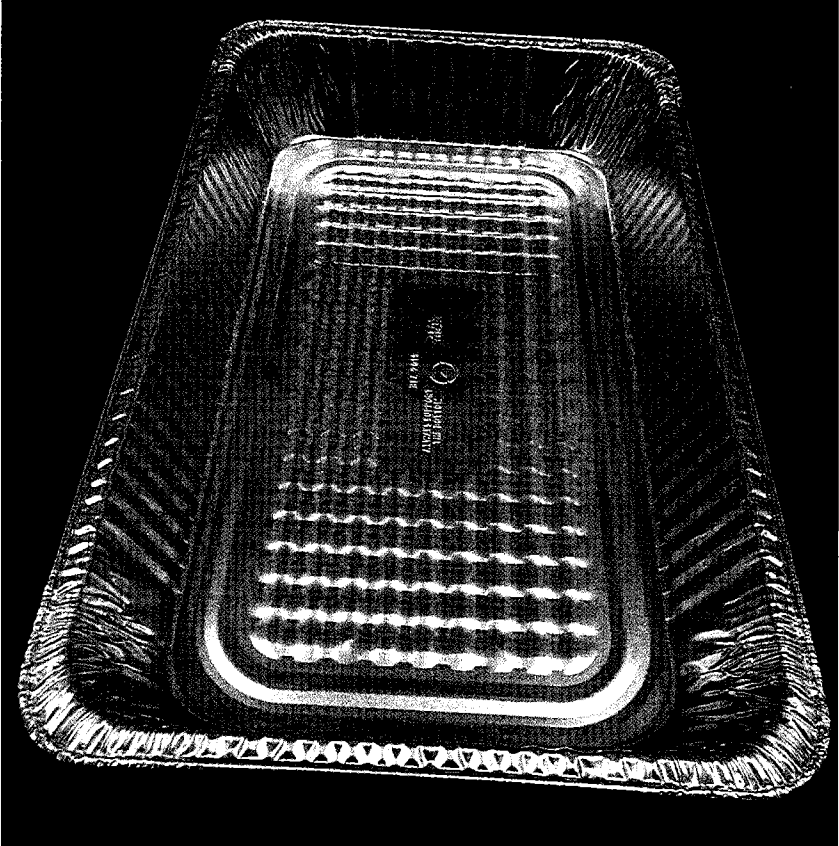

6132 ALUMINUM PAN

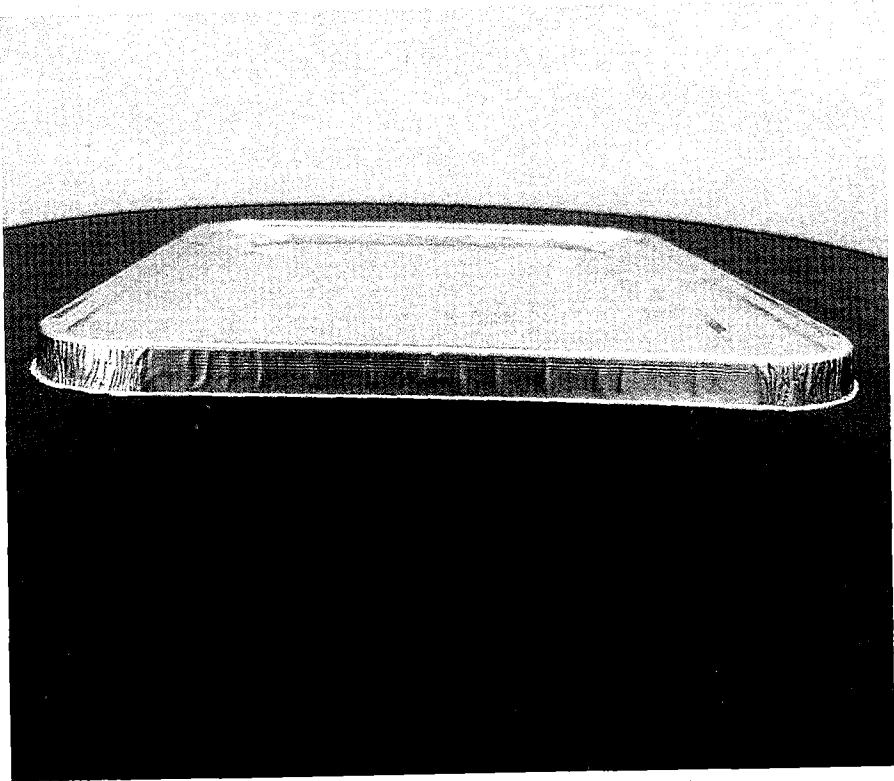
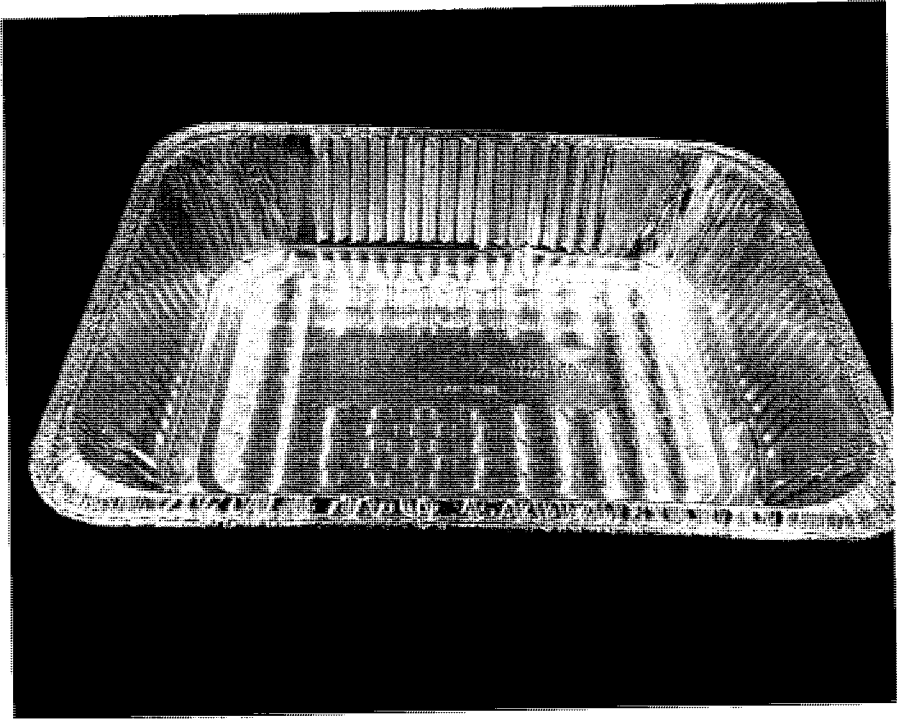

**Lunch Tray – 5 Compartment**

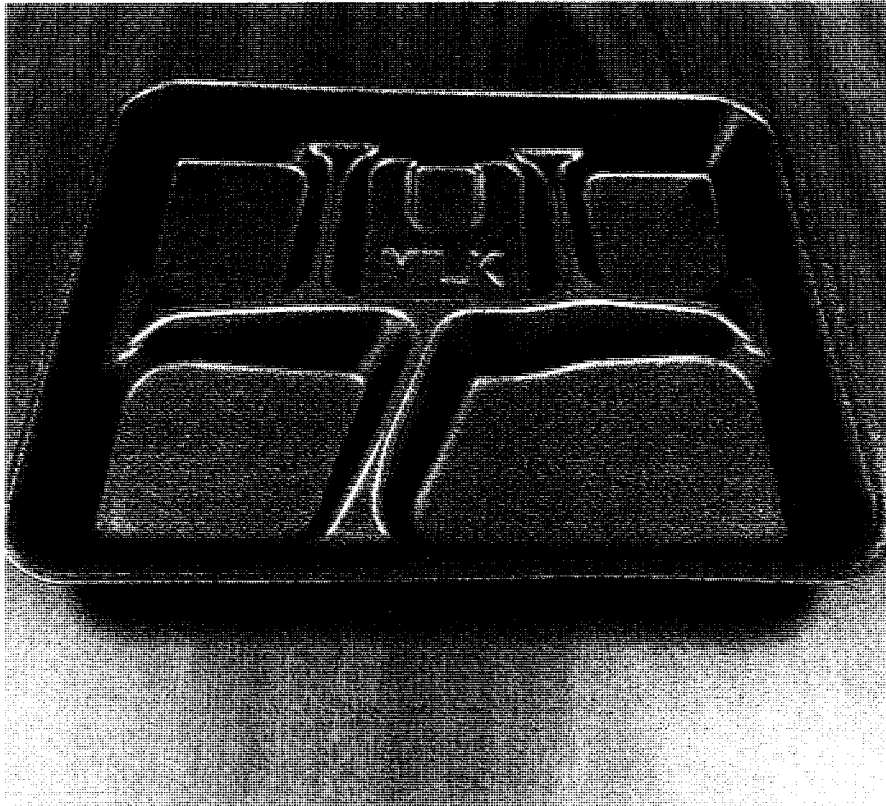

Homebound Aluminum 3-Compartment Tray w/ Lid

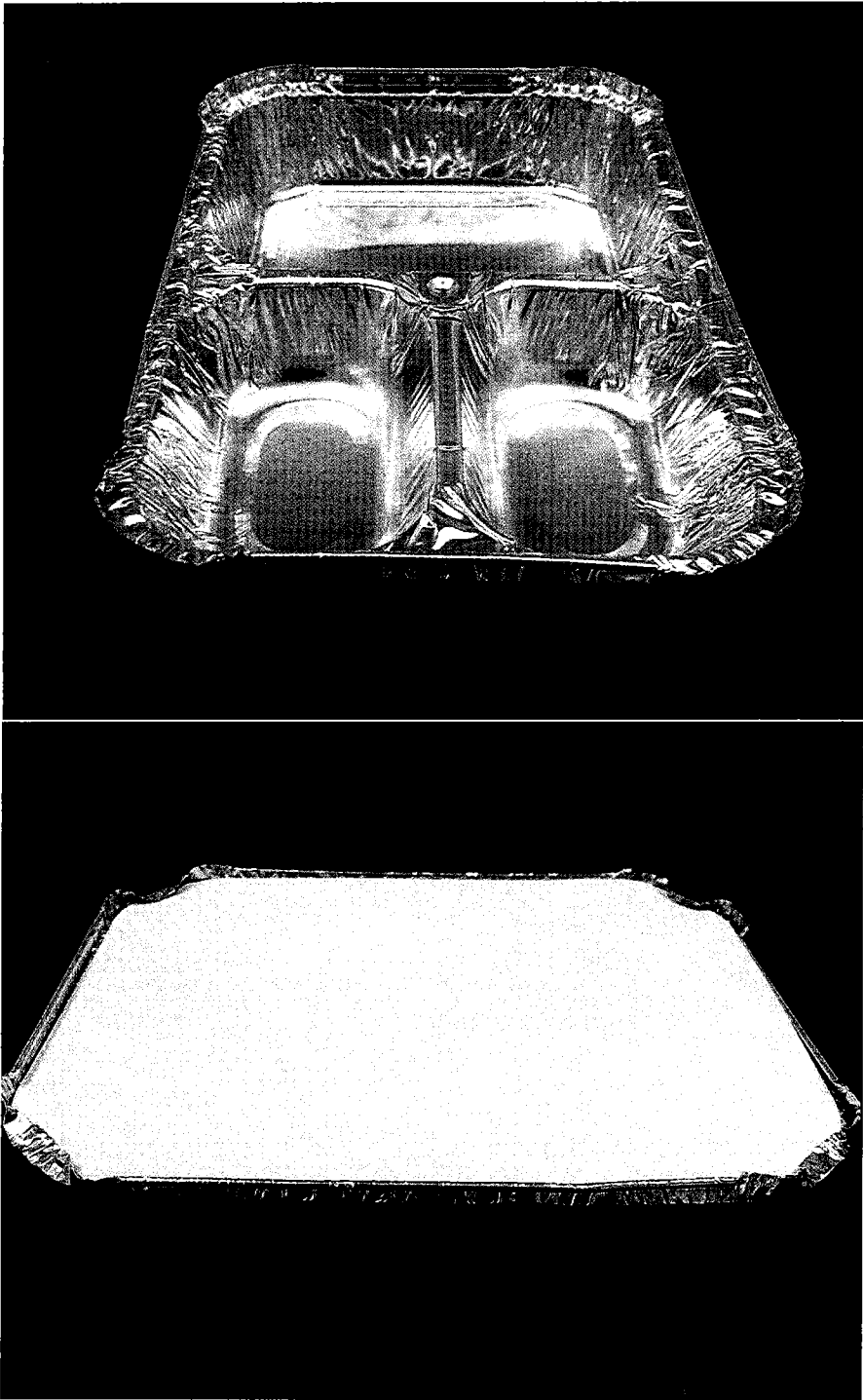

**Combo Pack 6/1 (Napkin, Spoon, Fork, Knife, Salt & Pepper) and Straw**

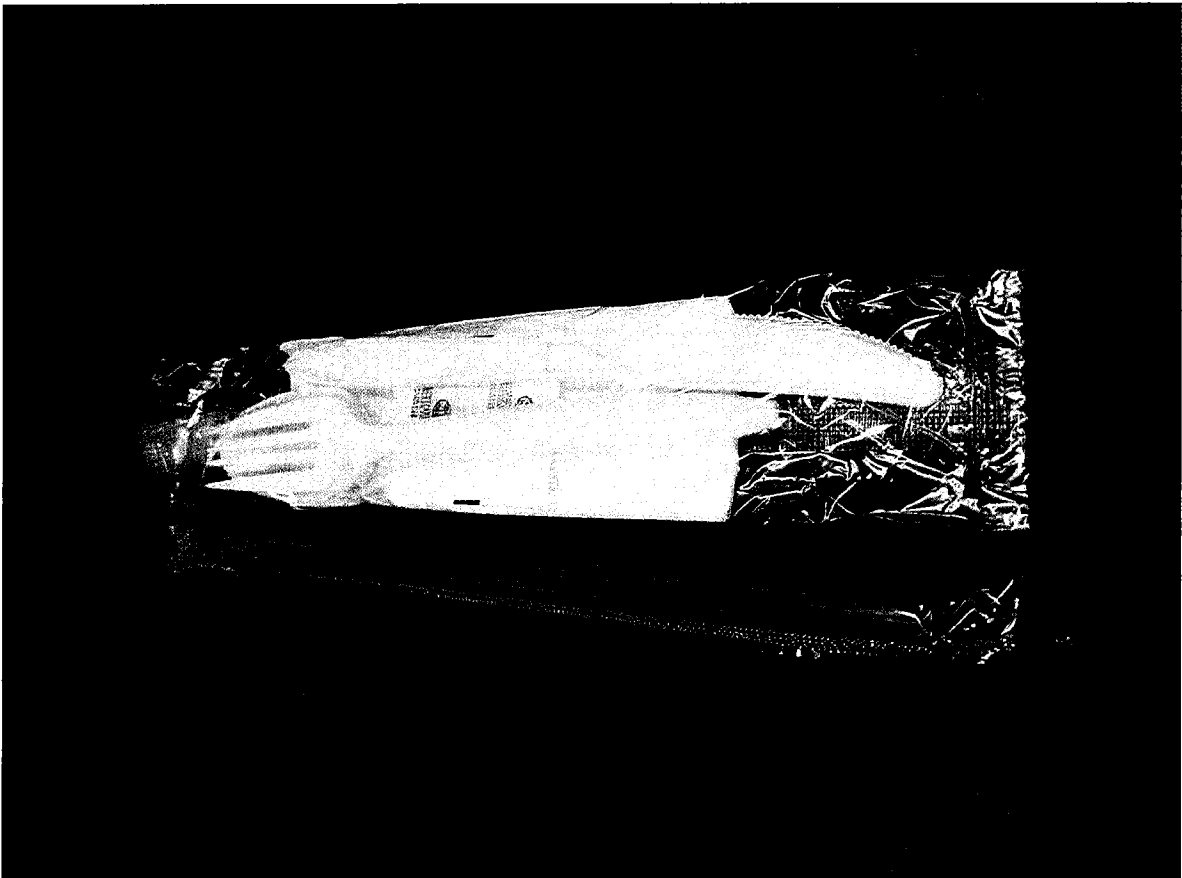

265



**8 oz. Styrofoam Bowl**

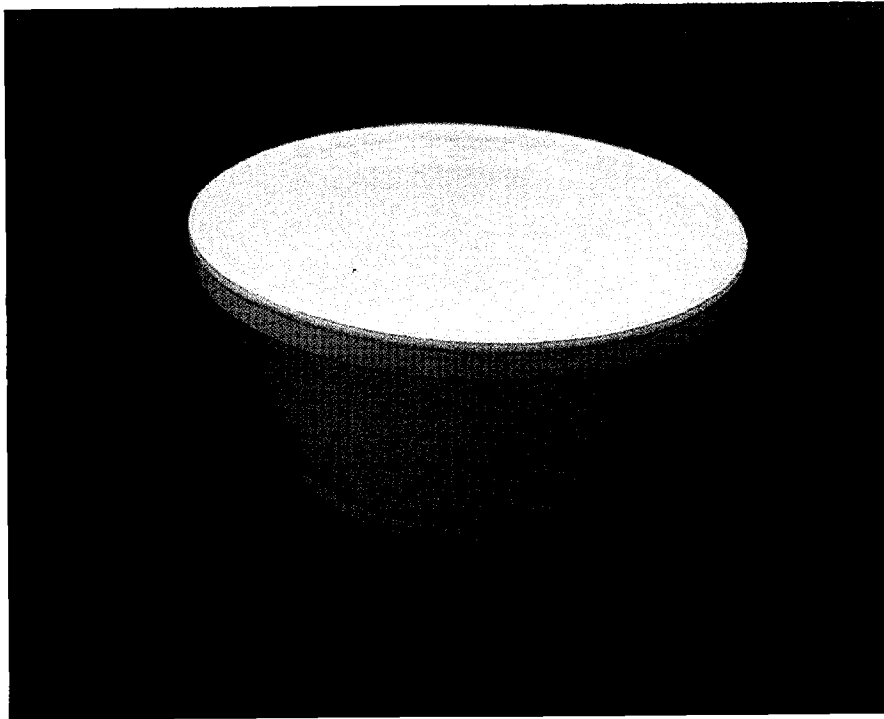

**8 oz. Styrofoam Cup**



705 Aluminum Tray w/ Lid

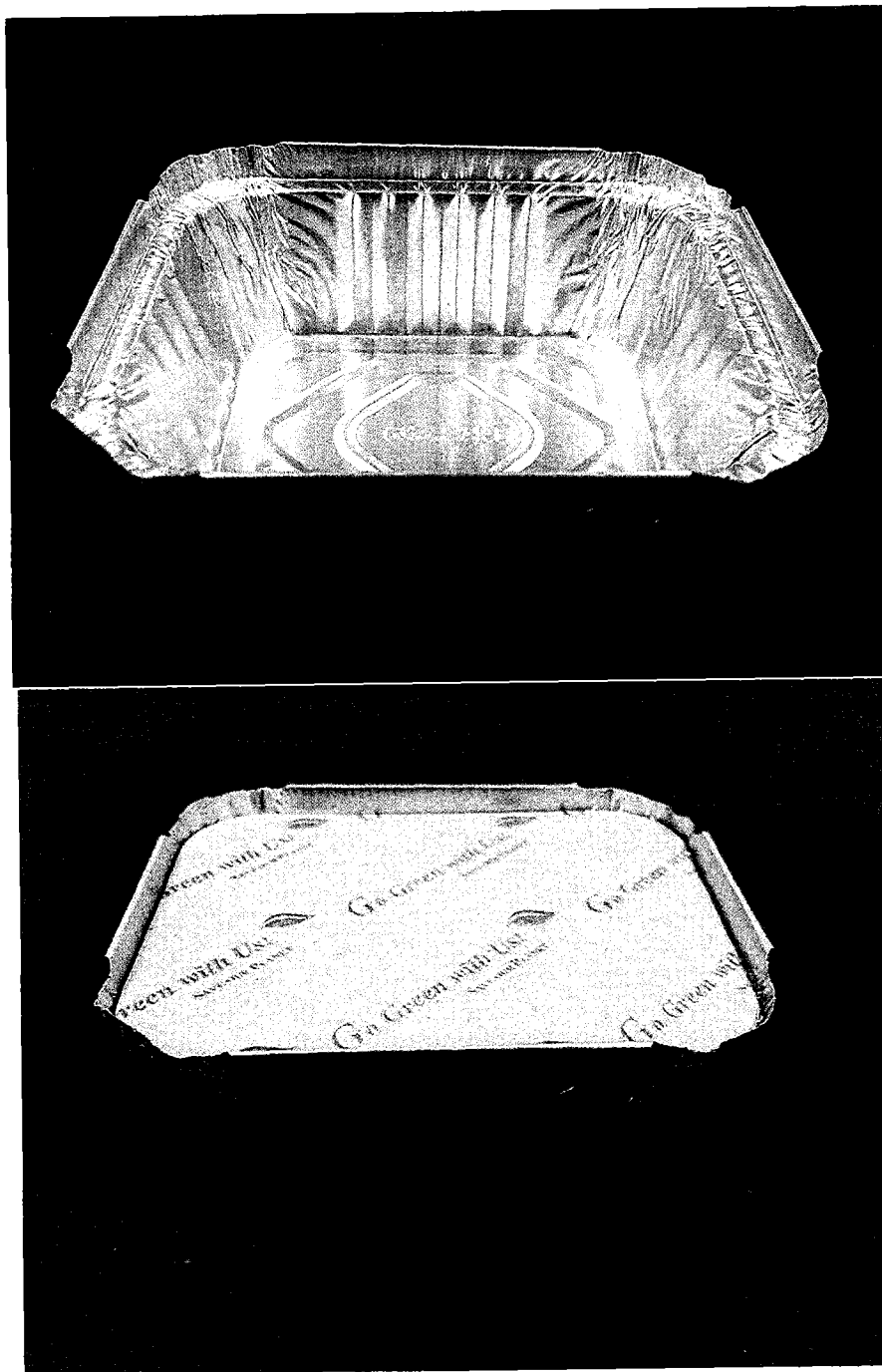

**Bread Sealing Plastic Bag**



6 oz. Plastic Cup w/ Lid

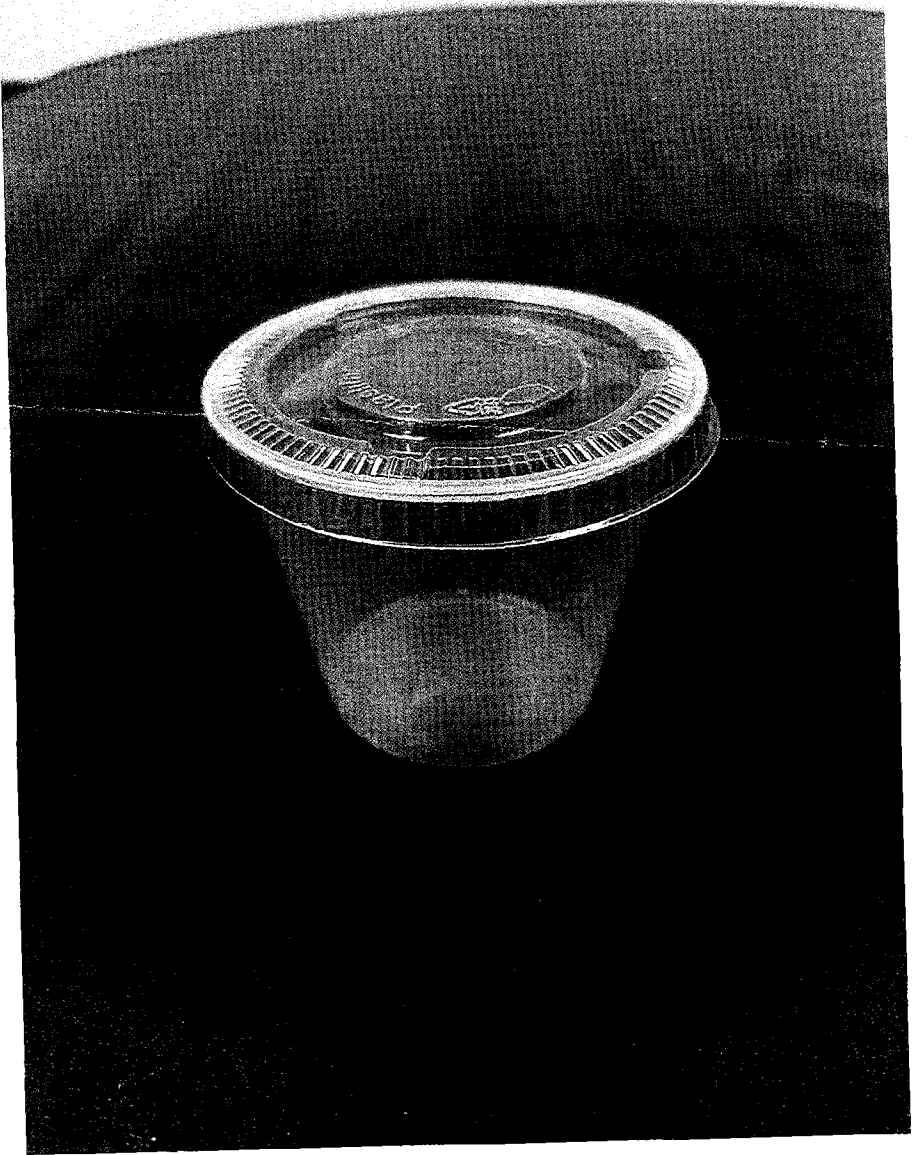

# Menu Attestation and Nutrient Analysis

Attachment-E

270

Attestation Statement

Nutrition Provider: Miami Springs Date: 5/18//21

Registered/Licensed Dietitian's name (please print): Marvick Melendez, MS, RD, LDN, CNSC

**Instructions:**

The purpose of this form is to assist the Alliance's dietician in reviewing the menus approved by the Provider's dietician. This attestation should include discussions and steps the RD has taken with the caterer to closely follow the Dietary Guidelines.

The dietician who developed the nutrient analysis must complete **Section I** of this attestation, even if it's the Provider's caterer that developed the nutrient analysis. **Section II** must be completed by the Provider's RD only. Each page of the menu must be signed by the Provider's RD ONLY.

**SECTION I**

I attest that the attached menus have been analyzed with computer software programming using Nutritionist Pro \_\_\_\_\_ (the name of the software). These menus meet DOEA's Computer-Assisted Menu Development requirements with the following specifics -

- Menus provide 33 1/3% of the Dietary Reference Intakes and approximately 600 calories per meal using the reference intakes for Age 70+ Females
- Analysis includes: Calories, Protein, Fat, Fiber, Calcium, Zinc, Sodium, Potassium, Magnesium, Vitamins B6, B12, C, and A
- Adequate amounts are provided daily of Calories, Protein, Fat, Fiber, Calcium, Vitamin B6 and Vitamin C
- Vitamins A and B12, Zinc, Magnesium, Sodium and Potassium are averaged over one week; however, no individual meal exceeds 1000 mg of Sodium
- These menus comply with the current Dietary Guidelines for Americans. The guidelines can be found at <http://www.health.gov/DietaryGuidelines/>

Marvick Melendez, MS, RD, LDN, CNSC  
Registered/Licensed - Signature

5/18/21  
Date

**SECTION II:**

- Menus attested to are for the following (use date and title of menus):

Miami Springs Congregate Menu B Cycle 2 effective July 19, 2021 - January 16, 2022  
Miami Springs Homebound Menu B Cycle 2 effective July 19, 2021 - January 16, 2022

- Dietitian's comments:

As requested, please refer to the attached page for a detailed list of any discrepancies found in the nutrient analysis. Note that it is very difficult to achieve 100% accuracy in nutrient analysis and that this is only an estimate of the actual nutrient composition of the meals served to seniors. When nutrients were not met to 100% of DRI's they are still close to the target (see attached). Low sodium items selected when possible.

Ronald Salas, MS, RD  
Registered/Licensed Dietitian- Signature

ND1885  
State of FL License #

RV 07/2017

271

## **Miami Springs Congregate Menu B Cycle 2**

Week 1:

Weekly needs met: Potassium 1567 mg, Mg 139 mg, Zn 6 mg, vitamin A 695 RE

Week 2:

Wed 678 kcal

Weekly needs: Potassium 1396 mg (90% goal), Mg 130 mg, Zn 6 mg, Vitamin A 681 RE

Week 3:

Weekly needs met: Potassium 1481 mg (94% goal), Mg 129 mg, Zn 5 mg, Vitamin A 344 RE

Week 4:

Weekly needs met: Potassium 1533 mg (98% of goal), Mg 138 mg, Zn 5.4 mg, Vitamin A 655 RE

## **Miami Springs Homebound Menu B Cycle 2**

Week 1

Sunday 790 kcal, 1121 mg sodium (low sodium items selected)

Weekly needs met: Potassium 1641 mg, Mg 133 mg, Zn 5.4 mg, Vitamin A 699 RE

Week 2:

Wed 678 kcal

Sunday 658 kcal, sodium 940 mg

Weekly needs met: Potassium 1349 mg (87% of goal), Mg 122 mg, Zn 5.2 mg, Vitamin A 713 RE

Week 3

Sunday 737 kcal, sodium 897 mg

Potassium 1402 mg (90% of goal), Mg 125 mg, Zn 5.5 mg, Vitamin A 469 RE

Week 4 Sunday 782 Kcal, sodium 708mg

Weekly nutrients met: Vitamin A 810 RE, potassium 1638 mg, Mg 137 mg, Zn 5 mg

RV 07/2017

272



# Menu Template Nutrition Summary

Total Days: 7  
Total Foods: 62

Avg. Daily Kcals: 561.029  
Name: Miami Springs Homebound Menu B C2W1

Nutrient Goal Template: New Nutrient Goal Template

Macronutrients	Value	Unit	Goal	%	Vitamins	Value	Unit	Goal	%
Kilocalories	561.029	kcal		*	Vitamin A (RE)	698.548	RE		*
Protein	39.086	g		*	Beta-Carotene	2112.133	mcg		*
Carbohydrate	74.994	g		*	Vitamin C	66.615	mg		*
Fat, Total	13.632	g		*	Vitamin D (ug)	3.105	mcg		*
Alcohol	0.000	g		*	Vitamin E (mg)	0.370	mg		*
Cholesterol	80.208	mg		*	Vitamin E (Alpha-Tocopherol)	2.003	mg		*
Saturated Fat	5.159	g		*	Thiamin	0.606	mg		*
Monounsaturated Fat	4.730	g		*	Riboflavin	0.930	mg		*
Polyunsaturated Fat	2.126	g		*	Niacin	9.054	mg		*
MFA 18:1, Oleic	4.074	g		*	Pyridoxine (Vitamin B6)	0.929	mg		*
PFA 18:2, Linoleic	1.751	g		*	Folate (Total)	119.933	mcg		*
PFA 18:3, Linolenic	0.201	g		*	Cobalamin (Vitamin B12)	2.278	mcg		*
PFA 20:5, EPA	0.000	g		*	Biotin	9.364	mcg		*
PFA 22:6, DHA	0.002	g		*	Pantothenic Acid	2.497	mg		*
Dietary Fiber, Total	10.218	g		*	Vitamin K	109.752	mcg		*
Sugar, Total	32.949	g		*					

Amino Acids	Value	Unit	Goal	%	Minerals	Value	Unit	Goal	%
Tryptophan	350.622	mg		*	Sodium	558.927	mg		*
Threonine	1270.420	mg		*	Potassium	1641.033	mg		*
Isoleucine	1412.688	mg		*	Calcium	503.569	mg		*
Leucine	2440.925	mg		*	Iron	4.139	mg		*
Lysine	2404.614	mg		*	Phosphorus	606.896	mg		*
Methionine	739.723	mg		*	Magnesium	133.301	mg		*
Cystine	315.725	mg		*	Zinc	5.416	mg		*
Phenylalanine	1352.056	mg		*	Copper	0.430	mg		*
Tyrosine	1145.083	mg		*	Manganese	1.319	mg		*
Valine	1640.203	mg		*	Selenium	34.646	mcg		*
Histidine	966.802	mg		*	Chromium	0.017	mg		*
					Molybdenum	14.969	mcg		*

(\* No Goal Value)

### Exchanges

Bread/Starch	2.00
Fat	0.00
Fruit	1.00
Meat-Lean	0.50
Meat-Medium Fat	1.00
Meat-Very Lean	1.00
Milk-Skim	1.00
Other Carbohydrate	0.00
Vegetables	1.50

### Percentage Of Kcals

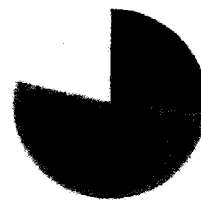

- Protein 27.0%
- Carbohydrate 51.8%
- Total Fat 21.2%
- Alcohol 0.0%





# Menu Template Report

274

Total Days: 7  
Total Foods: 62

Avg. Daily Kcal: 561.029  
Name: Miami Springs Homebound Menu B C2W1

Name	Amount	Unit	Kcal	Protein	Fat	Sodium	Vit A (IU)	Vit C	Calcium	Diet Fiber	Vit B6	Vit B12
			Kcal	g	g	mg	IU	mg	mg	g	mg	mcg
Monday			604.336	51.175	6.991	282.766	12037.350	25.180	539.554	16.339	1.371	1.524
Lunch			604.336	51.175	6.991	282.766	12037.350	25.180	539.554	16.339	1.371	1.524
Chicken, Roasting, Breast, Meat Only, Boneless, Skinless, Roasted	3.000	oz.	125.022	25.455	1.769	43.375	21.263	0.000	11.056	0.000	0.459	0.284
Juice, Lemon	1.000	fl. oz.	6.710	0.107	0.073	0.305	1.830	11.804	1.830	0.092	0.014	0.000
SPICE WORLD Garlic, Minced	1.000	t.	0.000	0.000	0.000	0.000	0.000	0.000	0.000	0.000	0.000	0.000
Beans, Kidney, California Fed, Booled	3.000	oz.	105.460	7.765	0.077	3.402	2.551	1.021	56.132	7.910	0.088	0.000
Soup, Chicken Broth, Low Sodium, Canned	4.000	oz.	18.144	2.268	0.680	34.019	0.000	0.000	4.536	0.000	0.011	0.113
Spinach, Chopped, Frozen, Booled, Drained	0.500	c.	32.300	3.810	0.827	92.150	11457.950	2.090	145.350	3.515	0.129	0.000
SPICE WORLD Garlic, Minced	1.000	t.	0.000	0.000	0.000	0.000	0.000	0.000	0.000	0.000	0.000	0.000
Banana	1.000	item	105.020	1.286	0.389	1.180	75.620	10.266	5.900	3.068	0.433	0.000
Rice, Brown, Medium Grain, Cooked	0.500	c.	109.200	2.262	0.809	0.975	0.000	0.000	9.750	1.755	0.145	0.000
Milk, Low Fat, 1%	8.000	fl. oz.	102.480	8.223	2.367	107.360	478.240	0.000	305.000	0.000	0.090	1.147
Tuesday			543.487	42.666	11.701	587.654	1081.073	24.923	457.431	8.802	0.825	3.373
Lunch			543.487	42.666	11.701	587.654	1081.073	24.923	457.431	8.802	0.825	3.373
Beef, Ground, 95% Lean Meat/5% Fat, Loaf, Baked	3.000	oz.	147.987	23.227	5.418	49.329	7.655	0.000	6.804	0.000	0.304	2.118
Gravy, beef or meat, low sodium	1.000	oz.	15.025	1.077	0.680	5.103	0.000	0.000	1.701	0.085	0.003	0.028
Potatoes, Mashed, Garlic	4.000	oz.	81.100	2.548	0.106	12.409	34.966	14.515	32.315	2.157	0.286	0.080
Green Beans	0.500	c.	17.050	1.007	0.121	3.300	379.500	6.710	20.350	1.485	0.078	0.000
Onions, Red, Sliced	1.000	oz.	11.340	0.312	0.028	1.194	0.000	2.098	6.520	0.482	0.034	0.000
JELLO Gelatin Mix, Lemon, Sugar Free, Low Calorie, Prepared	0.250	c.	12.500	0.000	0.000	150.000	0.000	0.000	0.000	0.000	0.000	0.000
Fruit Cocktail, Canned In Juice	0.250	c.	27.255	0.273	0.006	2.370	180.713	1.600	4.740	0.583	0.030	0.000
CC - Whole Wheat Dinner Rolls	2.000	item	120.000	6.000	2.000	220.000	0.000	0.000	80.000	4.000	0.000	0.000
Margarine-like spread, reduced calorie, about 20% fat, tub, salted	1.000	t.	8.750	0.000	0.975	36.650	0.000	0.000	0.000	0.000	0.000	0.000
Milk, Low Fat, 1%	8.000	fl. oz.	102.480	8.223	2.367	107.360	478.240	0.000	305.000	0.000	0.090	1.147
Wednesday			482.492	35.174	6.766	599.700	4164.672	24.070	385.596	7.878	0.954	1.575
Lunch			482.492	35.174	6.766	599.700	4164.672	24.070	385.596	7.878	0.954	1.575



# Menu Template Report

Total Days: 7  
Total Foods: 62

Avg. Daily Kcals: 561.029  
Name: Miami Springs Homebound Menu B C2W1

Name	Amount Unit	Kcal Kcal	Protein g	Fat g	Sodium mg	Vit A (IU) IU	Vit C mg	Calcium mg	Diet Fiber g	Vit B6 mg	Vit B12 mcg
Port, Fresh, Enhanced, Loin, Tenderloin, Separable Lean Only, Cooked, Roasted	3.000 oz.	98.656	18.379	2.679	196.462	0.000	0.000	4.252	0.000	0.519	0.400
Gravy, Au Jus, Canned	1.000 oz.	4.586	0.340	0.057	135.511	0.000	0.283	1.194	0.000	0.003	0.028
Potatoes, Red, Flash and Skin, Baked	4.000 oz.	98.656	2.608	0.170	13.608	11.340	14.288	10.206	2.041	0.240	0.000
Vegetables, Mixed, Frozen	0.500 c.	51.840	2.398	0.374	33.840	3656.160	7.488	18.000	2.880	0.069	0.000
Applesauce	4.000 oz.	46.323	0.227	0.119	2.920	18.932	2.011	7.004	0.957	0.032	0.000
CC - Whole Wheat Dinner Rolls	1.000 item	60.000	3.000	1.000	110.000	0.000	0.000	40.000	2.000	0.000	0.000
Milk, Low Fat, 1%	8.000 fl. oz.	102.480	8.223	2.367	107.360	478.240	0.000	305.000	0.000	0.090	1.147
Lunch		576.899	34.359	17.999	358.131	14214.610	40.707	400.983	7.446	0.864	3.707
Beef, Chuck Eye Roast, Boneless, Separable Lean and Fat, 0% Fat, Roasted	3.000 oz.	200.718	20.948	13.004	64.638	18.711	0.000	15.309	0.000	0.323	2.560
Pepper, Bell or Sweet, Green	1.000 fl. oz.	3.725	0.160	0.032	0.559	68.913	14.975	1.863	0.317	0.042	0.000
Onions, Red, Sliced	1.000 fl. oz.	5.750	0.158	0.014	0.575		1.084	3.306	0.244	0.017	0.000
Paste, Tomato, Canned, without Salt Added	1.000 T.	13.120	0.691	0.075	9.440	244.000	3.504	5.760	0.656	0.035	0.000
FRESH EXPRESS Salad, Spinach	0.500 c.	2.500	0.250	0.000	8.125	1000.000	3.000	10.000	0.250	0.000	0.000
Tomatoes, Cherry, Fresh	2.000 item	6.120	0.299	0.068	1.700		4.658	3.400	0.408	0.027	0.000
Italian dressing, light	1.000 T.	13.770	0.053	0.902	120.285	0.000	0.000	2.025	0.000	0.007	0.000
Carrots, Sliced, Frozen, Boiled, Drained	0.500 c.	27.010	0.423	0.496	43.070	12357.440	1.679	25.550	2.409	0.061	0.000
Pineapple, Canned In Juice	0.500 c.	74.700	0.523	0.100	1.245	47.310	11.828	17.430	0.996	0.092	0.000
Rice, Brown, Medium Grain, Cooked	4.000 oz.	127.006	2.631	0.941	1.134		0.000	11.340	2.166	0.169	0.000
Milk, Low Fat, 1%	8.000 fl. oz.	102.480	8.223	2.367	107.360	478.240	0.000	306.000	0.000	0.090	1.147
Friday		391.705	21.519	7.482	446.722	2343.580	231.312	607.828	13.132	0.601	1.294
Lunch		391.705	21.519	7.482	446.722	2343.580	231.312	607.828	13.132	0.601	1.294
Mariacolt, cheese-filled, with tomato sauce (diet frozen meal)	2.000 oz.	69.740	4.080	3.152	180.303	0.000	4.649	87.316	0.397	0.034	0.147
Broccoli	4.000 oz.	38.555	3.198	0.420	37.421	706.470	101.151	53.297	2.948	0.198	0.000
Tomatoes, Red	0.500 c.	16.200	0.792	0.180	4.500	749.700	12.330	9.000	1.080	0.072	0.000

Friday, May 7, 2021

275



# Menu Template Report

Total Days: 7  
Total Foods: 62

Avg. Daily Kcals: 561.029  
Name: Miami Springs Homebound Menu B C2W1

Name	Amount	Unit	Kcal	Protein	Fat	Sodium	Vit A (IU)	Vit C	Calcium	Diet Fiber	Vit B6	Vit B12
			kcal	g	g	mg	IU	mg	mg	g	mg	mcg
Cucumber	0.100	c.	1,560	0.068	0.011	0.208	10,920	0.291	1,664	0.052	0.004	0.000
Orange, with Peel	1.000	Item	100,170	2,067	0.477	3,180	397,500	112,890	111,300	7,155	0,148	0,000
Bread, Whole Wheat	1.000	sl.	63,000	3,113	0.875	113,750	0,750	0,000	40,250	1,500	0,054	0,000
Milk, Low Fat, 1%	8.000	fl. oz.	102,480	8,223	2,367	107,360	478,240	0,000	305,000	0,000	0,090	1,147
Saturday Lunch			558,102	40,379	10,934	516,247	4456,838	33,243	423,484	10,224	1,076	2,087
Chicken, Drumsticks, Roasted, Meat Only	3.000	oz.	129,274	22,623	4,337	144,583	56,693	0,000	13,608	10,224	1,076	2,087
Gravy, mushroom	1.000	T.	4,016	0,122	0,049	81,218	0,089	3,273	0,060	0,001	0,009	0,000
Potatoes, Mashed, Garlic	4.000	oz.	81,100	2,548	0,106	12,408	34,966	14,515	32,315	2,157	0,286	0,080
Vegetables, Mixed, Frozen	0.500	c.	51,840	2,398	0,374	33,840	3656,180	7,488	18,000	2,880	0,069	0,000
Garlic Clove	1.000	t.	4,222	0,160	0,014	0,482	0,255	0,984	5,126	0,080	0,035	0,000
Butter, Spread, Vegetable Oil, Reduced Calorie	1.000	t.	20,150	0,000	2,297	25,177	155,003	0,000	0,260	0,000	0,000	0,000
Banana	1.000	Item	105,020	1,286	0,389	1,180	75,520	10,266	5,900	3,068	0,433	0,000
CC - Whole Wheat Dinner Rolls	1.000	Item	60,000	3,000	1,000	110,000	0,000	0,000	40,000	2,000	0,090	1,147
Milk, Low Fat, 1%	8.000	fl. oz.	102,480	8,223	2,367	107,360	478,240	0,000	305,000	0,000	0,090	1,147
Sunday Lunch			790,182	48,329	33,549	1121,269	3075,901	86,871	710,105	7,705	0,812	2,389
Composite-Pork/Ham-All Cuts	3.000	oz.	790,182	48,329	33,549	1121,269	3075,901	86,871	710,105	7,705	0,812	2,389
Cheese, Swiss, Low Sodium	1.000	sl.	185,563	21,130	10,565	425,000	2,833	6,076	12,331	0,000	0,311	0,766
Bread, Whole Wheat	2.000	sl.	106,029	8,051	1,768	3,969	231,903	0,000	272,444	0,000	0,023	0,476
Chips, Potato	15.000	Item	128,000	6,225	1,750	227,500	1,500	0,000	80,500	3,000	0,108	0,000
V8 100% Juice, Vegetable, Low Sodium	8.000	fl. oz.	162,600	1,968	10,920	157,500	0,000	5,560	7,200	1,320	0,217	0,000
Fruit Cocktail, Canned in Juice	0.500	c.	54,510	0,545	0,012	4,740	361,425	3,200	9,480	1,185	0,060	0,000
Mustard	1.000	t.	3,000	0,187	0,167	55,200	0,000	0,015	3,150	0,200	0,004	0,000
Milk, Low Fat, 1%	8.000	fl. oz.	102,480	8,223	2,367	107,360	478,240	0,000	305,000	0,000	0,090	1,147

276



# Menu Template Report

277

Total Days: 7  
Total Foods: 62

Avg. Daily Kcals: 561.029  
Name: Miami Springs Homebound Menu B C2W1

Name	Amount Unit	Potas mg	Magn mg	Zinc mg
<b>Monday</b>				
Lunch		1838.371	242.849	3.795
Chicken, Roasting, Breast, Meat Only, Boneless, Skinless, Roasted	3.000 oz.	1838.371	242.849	3.795
Only, Boneless, Skinless, Roasted	3.000 oz.	200.716	19.561	0.663
Juice, Lemon	1.000 fl. oz.	31.415	1.830	0.015
SPICE WORLD Garlic, Minced	1.000 t.			
Beans, Kidney, California Red, Boiled	3.000 oz.	356.353	40.823	0.731
Soup, Chicken Broth, Low Sodium, Canned	4.000 oz.	97.522	1.134	0.113
Spirnach, Chopped, Frozen, Boiled, Drained	0.500 c.	286.900	77.900	0.466
SPICE WORLD Garlic, Minced	1.000 t.	422.440	31.860	0.177
Banana	1.000 item	77.025	42.900	0.605
Rice, Brown, Medium Grain, Cooked	0.500 c.	366.000	26.840	1.025
Milk, Low Fat, 1%	8.000 fl. oz.	1266.498	90.079	7.720
<b>Tuesday</b>				
Lunch		1266.498	90.079	7.720
Beef, Ground, 95% Lean Meat / 5% Fat, Loaf, Baked	3.000 oz.	267.908	18.711	5.894
Gravy, beef or meat, low sodium	1.000 oz.	22.963	0.567	0.283
Potatoes, Mashed, Garlic	4.000 oz.	394.650	23.178	0.343
Green Beans	0.500 c.	116.050	13.750	0.132
Onions, Red, Sliced	1.000 oz.	41.390	2.835	0.048
JELLO Gelatin Milk, Lemon, Sugar Free, Low Calorie, Prepared	0.250 c.			
Fruit Cocktail, Canned in Juice	0.250 c.	56.288	4.148	0.063
CG - Whole Wheat Dinner Rolls	2.000 item			
Margarine-like spread, reduced calorie, about 20% fat, tub, salted	1.000 t.	1.250	0.050	0.000
Milk, Low Fat, 1%	8.000 fl. oz.	366.000	26.840	1.025
<b>Wednesday</b>				
Lunch		1735.233	102.126	3.834
		1735.233	102.126	3.834



# Menu Template Report

Total Days: 7      Avg. Daily Kcals: 561.029  
 Total Foods: 62      Name: Miami Springs Homebound Menu B C2W1

Name	Amount Unit	Potas mg	Magn mg	Zinc mg
Pork, Fresh, Enhanced, Loin, Tenderloin, Separable Lean Only, Cooked, Roasted	3.000 oz.	482.225	21.262	1.701
Gravy, Au Jus, Canned	1.000 oz.	22.963	0.567	0.283
Potatoes, Red, Fresh and Skin, Baked	4.000 oz.	618.019	31.751	0.454
Vegetables, Mixed, Frozen	0.500 c.	152.640	17.280	0.324
Applesauce	4.000 oz.	93.385	4.425	0.047
CC - Whole Wheat Dinner Rolls	1.000 item			
Milk, Low Fat, 1%	8.000 fl. oz.	366.000	26.840	1.025
Thursday Lunch		1318.140	141.005	9.535
Beef, Chuck Eye Roast, Boneless, America's Beef Roast, All Grades, Separable Lean and Fat, 0" Fat, Roasted	3.000 oz.	1318.140	141.005	9.535
Pepper, Bell or Sweet, Green	1.000 fl. oz.	261.954	17.010	7.212
Onions, Red, Sliced	1.000 fl. oz.			
Paste, Tomato, Canned, without Salt Added	1.000 T.	32.594	1.863	0.024
FRESH EXPRESS Salad, Spinach	0.500 c.	20.988	1.438	0.024
Tomatoes, Cherry, Fresh	2.000 item	162.240	6.720	0.101
Italian dressing, light	1.000 T.			
Carrots, Sliced, Frozen, Boiled, Drained	0.500 c.	80.580	3.740	0.058
Pineapple, Canned in Juice	0.500 c.	12.150	0.540	0.008
Rice, Brown, Medium Grain, Cooked	4.000 oz.	140.160	8.030	0.256
Milk, Low Fat, 1%	8.000 fl. oz.	151.890	17.430	0.125
Friday Lunch		89.584	49.895	0.703
Mannicotti, cheese-filled, with tomato sauce (diet frozen meal)	2.000 oz.	366.000	26.840	1.025
Broccoli	4.000 oz.	1408.578	110.853	2.791
Tomatoes, Red	0.500 c.	80.513	7.938	0.510
		358.338	23.814	0.465
		213.300	9.900	0.153

Friday, May 7, 2021

278



# Menu Template Report

Total Days: 7  
Total Foods: 62

Avg. Daily Kcals: 561.029  
Name: Miami Springs Homebound Menu B C2W1

Name	Amount Unit	Potas mg	Magn mg	Zinc mg
Cucumber	0.100 c.	15.288	1.352	0.021
Orange, with Peel	1.000 Item	311.840	22.260	0.175
Bread, Whole Wheat	1.000 sl.	63.500	18.750	0.443
Milk, Low Fat, 1%	8.000 fl. oz.	366.000	26.840	1.025
Saturday		1571.899	121.724	4.048
Lunch		1571.899	121.724	4.048
Chicken, Drumsticks, Roasted, Meat Only	3.000 oz.	221.126	21.262	2.126
Gravy, mushroom	1.000 T.	3.421	0.595	0.019
Potatoes, Mashed, Garlic	4.000 oz.	394.650	23.178	0.343
Vegetables, Mixed, Frozen	0.500 c.	152.640	17.280	0.324
Garlic Clove	1.000 t.	11.362	0.708	0.033
Butter, Spread, Vegetable Oil, Reduced Calorie	1.000 t.	0.250	0.000	0.000
Banana	1.000 Item	422.440	31.860	0.177
CC - Whole Wheat Dinner Rolls	1.000 Item	366.000	26.840	1.025
Milk, Low Fat, 1%	8.000 fl. oz.	2348.511	124.468	6.191
Sunday		2348.511	124.468	6.191
Lunch		311.268	18.227	2.320
Composite-Pork/Ham-All Cuts	3.000 oz.	31.469	10.205	1.106
Cheese, Swiss, Low Sodium	1.000 sl.	127.000	37.500	0.885
Bread, Whole Wheat	2.000 sl.	482.600	21.000	0.717
Chips, Potato	15.000 Item	900.000		
V8 100% Juice, Vegetable, Low Sodium	8.000 fl. oz.			
Fruit Cocktail, Canned in Juice	0.500 c.	112.575	8.295	0.107
Mustard	1.000 t.	7.600	2.400	0.032
Milk, Low Fat, 1%	8.000 fl. oz.	366.000	26.840	1.025

279



# Menu Template Nutrition Summary

Total Days: 7  
Total Foods: 67

Avg. Daily Kcals: 612.961  
Name: Miami Springs Homebound Menu B C2W2

Nutrient Goal Template: New Nutrient Goal Template

Macronutrients	Value	Unit	Goal	%	Vitamins	Value	Unit	Goal	%
Kilocalories	612.961	kcal		*	Vitamin A (RE)	713.081	RE		*
Protein	41.004	g		*	Beta-Carotene	2427.364	mcg		*
Carbohydrate	76.320	g		*	Vitamin C	61.375	mg		*
Fat, Total	16.330	g		*	Vitamin D (ug)	3.166	mcg		*
Alcohol	0.644	g		*	Vitamin E (mg)	0.495	mg		*
Cholesterol	90.517	mg		*	Vitamin E (Alpha-Tocopherol)	1.579	mg		*
Saturated Fat	6.716	g		*	Thiamin	0.508	mg		*
Monounsaturated Fat	5.556	g		*	Riboflavin	0.919	mg		*
Polyunsaturated Fat	2.139	g		*	Niacin	9.108	mg		*
MFA 18:1, Oleic	4.335	g		*	Pyridoxine (Vitamin B6)	0.702	mg		*
PFA 18:2, Linoleic	1.706	g		*	Folate (Total)	124.508	mcg		*
PFA 18:3, Linolenic	0.191	g		*	Cobalamin (Vitamin B12)	2.183	mcg		*
PFA 20:5, EPA	0.004	g		*	Biotin	4.666	mcg		*
PFA 22:6, DHA	0.009	g		*	Pantothenic Acid	1.821	mg		*
Dietary Fiber, Total	9.924	g		*	Vitamin K	59.428	mcg		*
Sugar, Total	33.618	g		*					

Amino Acids	Value	Unit	Goal	%	Minerals	Value	Unit	Goal	%
Tryptophan	300.853	mg		*	Sodium	620.930	mg		*
Threonine	1144.100	mg		*	Potassium	1349.468	mg		*
Isoleucine	1323.196	mg		*	Calcium	527.122	mg		*
Leucine	2280.874	mg		*	Iron	4.438	mg		*
Lysine	2158.273	mg		*	Phosphorus	588.049	mg		*
Methionine	683.176	mg		*	Magnesium	122.686	mg		*
Cystine	325.951	mg		*	Zinc	5.298	mg		*
Phenylalanine	1239.913	mg		*	Copper	0.372	mg		*
Tyrosine	995.450	mg		*	Manganese	0.862	mg		*
Valine	1500.576	mg		*	Selenium	42.328	mcg		*
Histidine	867.819	mg		*	Chromium	0.015	mg		*
					Molybdenum	7.504	mcg		*

(\* No Goal Value)

### Exchanges

Bread/Starch	1.50
Fat	0.50
Fruit	1.00
Meat-High Fat	0.00
Meat-Lean	2.00
Meat-Medium Fat	0.50
Meat-Very Lean	0.00
Milk-Skim	0.50
Other Carbohydrate	0.00
Vegetables	1.00

### Percentage Of Kcals

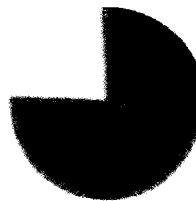

- Protein 26.4%
- Carbohydrate 49.2%
- Total Fat 23.7%
- Alcohol 0.7%

280



# Menu Template Report

28

Total Days: 7  
Total Foods: 67

Avg. Daily Kcals: 612.961  
Name: Miami Springs Homebound Menu B C2W2

Name	Amount	Unit	Kcal	Protein	Fat	Sodium	Vit A (IU)	Vit C	Calcium	Diet Fiber	Vit B6	Vit B12
			Kcal	g	g	mg	IU	mg	mg	g	mg	mcg
Monday	608.892		608.892	34.299	20.925	499.003	2358.129	32.450	470.556	8.425	0.522	2.402
Lunch	608.892		608.892	34.299	20.925	499.003	2358.129	32.450	470.556	8.425	0.522	2.402
Meatballs, Baked	3.000	oz.	212.875	15.662	13.660	132.890	54.439	0.295	34.298	0.424	0.123	1.256
Green Beans	0.500	c.	17.050	1.007	0.121	3.300	379.500	6.710	20.350	1.485	0.078	0.000
Almonds, Sliced	1.000	l.	11.098	0.405	0.967	0.019	0.038	0.000	5.156	0.240	0.003	0.000
Salad, Mixed Baby Greens with Arugula, Butterhead, Endive, Radicchio	0.500	c.	3.732	0.303	0.057	3.494	255.488	1.732	10.400	0.348	0.010	0.000
Italian dressing, light	1.000	T.	13.770	0.053	0.902	120.285	0.000	0.000	2.025	0.000	0.007	0.000
Mandarin Oranges or Tangerines	1.000	Item	44.520	0.680	0.260	1.680	772.800	22.428	31.080	1.512	0.066	0.000
Pasta, Spaghetti, Enriched, Cooked	0.500	c.	110.600	4.060	0.651	0.700	0.000	0.000	4.900	1.280	0.034	0.000
Sauce, Spaghetti Pasta, Low Sodium	2.000	fl. oz.	32.768	0.906	0.951	19.275	417.625	1.285	17.348	1.157	0.111	0.000
Milk, Low Fat, 1%	8.000	fl. oz.	102.480	8.223	2.367	107.360	478.240	0.000	305.000	0.000	0.090	1.147
CC - Whole Wheat Dinner Rolls	1.000	Item	60.000	3.000	1.000	110.000	0.000	0.000	40.000	2.000	0.086	0.000
Tuesday	588.724		588.724	36.877	9.519	481.493	1625.742	42.116	345.333	5.783	0.846	1.147
Lunch	588.724		588.724	36.877	9.519	481.493	1625.742	42.116	345.333	5.783	0.846	1.147
Chicken, Breast, Casseroled, Meat Only	3.000	oz.	136.078	24.154	4.423	51.029	0.000	0.000	7.654	1.157	0.306	0.000
Porto (Port wine)	1.000	oz.	44.366	0.028	0.000	1.134	0.000	0.000	1.134	0.000	0.003	0.000
Plantain	0.500	c.	90.280	0.962	0.259	2.960	833.980	13.616	2.220	1.258	0.179	0.000
Composite-Salad, Lettuce/Celery/Onion/Pepper	0.500	c.	18.550	0.865	0.120	14.800	220.500	27.900	13.850	1.220	0.110	0.000
Italian dressing, light	1.000	T.	13.770	0.053	0.902	120.285	0.000	0.000	2.025	0.000	0.007	0.000
Rice, Brown, Medium Grain, Cooked	0.500	c.	109.200	2.262	0.809	0.975	0.000	0.000	9.750	1.755	0.145	0.000
Crackers, Cuban	1.000	Item	21.500	0.280	0.640	22.950	0.000	0.000	3.700	0.050	0.005	0.000
Milk, low fat (1%)	1.000	c.	102.480	8.223	2.367	107.360	471.262	0.000	305.000	0.000	0.090	1.147
JELLO Gelatin Mix, Lemon, Sugar Free, Low Calorie, Prepared	0.250	c.	12.500	0.000	0.000	150.000	0.000	0.000	0.000	0.000	0.000	0.000
S&W Chunky Mixed Fruit, Natural Style, Canned In Juice	0.250	c.	40.000	0.250	0.000	10.000	100.000	0.600	0.000	1.500	0.808	3.573
Wednesday	678.678		678.678	48.685	9.157	404.284	3985.948	15.984	419.381	16.578	0.808	3.573
Lunch	678.678		678.678	48.685	9.157	404.284	3985.948	15.984	419.381	16.578	0.808	3.573





# Menu Template Report

282

Total Days: 7  
Total Foods: 67

Avg. Daily Kcals: 612.961  
Name: Miami Springs Homebound Menu B C2W2

Name	Amount Unit	Kcal	Protein g	Fat g	Sodium mg	Vit A (IU)	Vit C mg	Calcium mg	Diet Fiber g	Vit B6 mg	Vit B12 mcg
Beef, Ground, 97% Lean / 3% Fat, Crumbles, Pan-Browned	3.000 oz.	148.836	25.055	4.644	71.441	7.654	0.000	5.953	0.000	0.364	2.381
HUNT'S Paste, Tomato, No Salt Added	2.000 T.	90.000	1.000	0.000	20.000	300.000	2.400	0.000	2.000		
Beans, Kidney, California Fed, Boiled	0.500 c.	109.740	8.080	0.080	3.540	2.655	1.062	58.410	8.231	0.092	0.000
DOLE Salad, Spinach	1.000 oz.	6.867	0.667	0.000	22.333	2666.667	8.000	26.667	0.667	0.000	0.045
Italian dressing, fat free	1.000 T.	6.786	0.140	0.126	162.989	0.000	0.058	4.331	0.087	0.000	0.000
Cormeal, Yellow, Whole Grain	0.250 c.	110.410	2.477	1.095	10.675	65.270	0.000	1.830	2.227	0.093	0.000
Peach, Halves, Canned in Juice	0.500 c.	54.560	0.781	0.037	4.980	472.440	4.484	7.440	1.612	0.024	0.000
Rice, Brown, Medium Grain, Cooked	0.500 c.	109.200	2.262	0.809	0.975	0.000	0.000	9.750	1.755	0.145	0.000
Milk, low fat (1%)	1.000 c.	102.480	8.223	2.367	107.360	471.262	0.000	305.000	0.000	0.090	1.147
Thursday Lunch		640.536	46.482	18.459	715.159	12240.740	132.593	699.045	9.862	0.772	1.867
Chicken, Broiler, Back, Water	3.000 oz.	640.836	46.482	18.459	715.159	12240.740	132.593	699.045	9.862	0.772	1.867
Chili, Meat Only, Roasted		143.733	21.169	5.919	81.647	80.798	0.000	20.412	0.000	0.289	0.265
Sauce, Barbecue	0.500 oz.	17.887	0.219	0.042	115.971	91.733	1.513	3.671	0.040	0.016	0.002
Carrots	0.500 c.	25.010	0.567	0.146	42.090	10190.660	3.599	20.130	1.708	0.084	0.000
Tomatoes, Red	2.000 fl. oz.	8.100	0.396	0.090	2.250	374.850	6.165	4.500	0.540	0.036	0.000
Onions, Red, Sliced	1.000 sl.	5.600	0.154	0.014	0.560		1.036	3.220	0.238	0.017	0.000
Broccoli	2.000 oz.	19.278	1.599	0.210	18.711	353.235	50.576	26.649	1.474	0.099	0.000
Orange	1.000 item	61.570	1.231	0.157	0.000	294.750	69.692	62.400	3.144	0.079	0.000
Macaroni and Cheese, Baked	0.500 c.	196.678	9.924	8.514	236.570	383.450	0.013	223.063	0.718	0.061	0.463
CC - Whole Wheat Dinner Rolls	1.000 item	60.600	3.000	1.000	110.000	0.000	0.000	40.000	2.000		
Milk, low fat (1%)	1.000 c.	102.480	8.223	2.367	107.360	471.262	0.000	305.000	0.000	0.090	1.147
Friday Lunch		559.187	41.765	17.365	715.143	7288.955	34.078	581.861	5.941	0.541	3.024
Milk, low fat (1%)	1.000 c.	102.480	8.223	2.367	107.360	471.262	0.000	305.000	0.000	0.090	1.147
Composite-Pasta, Cooked	0.500 c.	95.000	3.220	0.453	0.675	0.000	0.000	4.725	1.020	0.024	0.000
Beef, Ground, 97% Lean / 3% Fat, Crumbles, Pan-Browned	2.000 oz.	99.224	16.704	3.096	47.627	5.103	0.000	3.969	0.000	0.243	1.588
Composite-Cheese, Cheddar/Colby/American/Montere y Jack	1.000 oz.	110.000	6.750	8.990	228.000	231.310	0.000	196.000	0.000	0.022	0.225



# Menu Template Report

283

Total Days: 7  
Total Foods: 67

Avy: Daily Kcals: 612.961  
Name: Miami Springs Homebound Menu B C21WZ

Name	Amount Unit	Kcal	Protein g	Fat g	Sodium mg	Vit A (IU)	Vit C mg	Calcium mg	Diet Fiber g	Vit B6 mg	Vit B12 mcg
Vegetables, Mixed, Frozen	0.250 c.	25.920	1.199	0.187	16.920	1828.080	3.744	9.000	1.440	0.035	0.000
Soup, Chicken Broth, Low Sodium, Canned	0.250 c.	9.600	1.200	0.360	18.000		0.000	2.400	0.000	0.006	0.060
Lettuce, Romaine, Shredded	0.500 c.	3.995	0.289	0.071	1.880	2048.850	0.940	7.755	0.494	0.017	0.000
Salad Dressing, Caesar, Low Calorie	1.000 T.	16.500	0.045	0.660	172.200	0.750	0.000	3.600	0.015	0.000	0.005
Cantaloupe	0.500 c.	27.200	0.672	0.152	12.800	2705.600	29.360	7.200	0.720	0.058	0.000
CC - Whole Wheat Dinner Rolls	1.000 item	60.000	3.000	1.000	110.000	0.000	0.000	40.000	2.000	0.046	0.000
Garlic Powder	1.000 t.	9.268	0.463	0.020	1.680	0.000	0.034	2.212	0.252	0.000	0.000
Saturday Lunch		556.130	41.362	14.518	591.416	10337.850	49.446	478.230	10.026	0.826	1.512
Turkey, Breast, Meat and Skin, Roasted	3.000 oz.	556.130	41.352	14.518	591.416	10337.850	49.446	478.230	10.026	0.826	1.512
Gravy, Meat or Poultry, Low Sodium, Prepared	1.000 T.	160.743	24.418	6.302	53.581	0.000	0.000	17.860	0.000	0.408	0.308
Potatoes, Sweet	0.500 c.	7.817	0.560	0.354	2.655		0.000	0.885	0.044	0.001	0.015
Broccoli	0.500 c.	67.190	1.044	0.033	36.575	9434.354	1.596	19.950	1.995	0.139	0.000
Sauce, Cheese	1.000 fl. oz.	15.470	1.283	0.168	15.015	283.465	40.586	21.385	1.183	0.080	0.000
Pear	1.000 item	54.810	2.114	4.186	260.820	99.540	0.126	57.960	0.158	0.005	0.044
Bread, Whole Wheat	1.000 sl.	94.620	0.598	0.232	1.660	41.500	7.138	14.940	5.146	0.048	0.000
Milk, Low Fat, 1%	8.000 fl. oz.	63.000	3.113	0.875	113.750	0.750	0.000	40.250	1.500	0.054	0.000
Sunday Lunch		102.480	8.223	2.367	107.360	478.240	0.000	305.000	0.000	0.090	1.755
Composite-Pork/Ham-All Cuts	2.000 oz.	658.579	37.571	24.378	940.013	3124.479	122.960	695.447	12.851	0.601	1.755
BOARIS HEAD Cheese, Povidone, 44% Lower Sodium	1.000 oz.	123.709	14.087	7.043	283.333	1.889	4.051	8.221	0.000	0.207	0.511
Roll, whole wheat, hamburger bun	1.000 item	100.000	7.000	7.000	140.000	200.000	0.000	200.000	0.000	0.000	0.000
SUNCHIPS Multigrain Snacks, Original	1.000 oz.	75.320	3.466	1.226	119.560	0.000	0.364	55.440	1.708	0.054	0.053
Lettuce, Romaine, Shredded	0.500 c.	140.000	2.000	6.000	120.000	0.000	0.000	0.000	3.000	0.057	0.000
Tomatoes, Cherry, Fresh	2.000 item	3.995	0.289	0.071	1.880	2048.850	0.940	7.755	0.494	0.017	0.000
Orange, with Peel	1.000 item	6.120	0.299	0.068	1.700		4.658	3.400	0.408	0.027	0.000
Italian dressing, fat free	1.000 T.	100.170	2.067	0.477	3.180	397.500	112.890	111.300	7.155	0.148	0.000
Milk, Low Fat, 1%	8.000 fl. oz.	6.786	0.140	0.126	182.999	0.000	0.058	4.331	0.087	0.000	0.045
		102.480	8.223	2.367	107.360	478.240	0.000	305.000	0.000	0.090	1.747



# Menu Template Report

284

Total Days: 7  
Total Foods: 67

Avg. Daily Kcals: 612.961  
Name: Miami Springs Homebound Menu B C2W2

Name	Amount Unit	Potas mg	Magn mg	Zinc mg
<b>Monday</b>				
Lunch		1194.909	104.157	5.082
Meatballs, Baked	3.000 oz.	1194.909	104.157	5.082
Green Beans	0.500 c.	249.843	19.951	3.209
Almonds, Sliced	1.000 t.	116.050	13.750	0.192
Salad, Mixed Baby Greens with Arugula, Butterhead, Endive, Radicchio	0.500 c.	14.049	5.175	0.080
Italian dressing, light	1.000 T.	61.819	3.857	0.104
Mandarin Oranges or Tangerines	1.000 item	12.150	0.540	0.008
Pasta, Spaghetti, Enriched, Cooked	0.500 c.	139.440	10.080	0.059
Sauce, Spaghetti Pasta, Low Sodium	2.000 fl. oz.	30.800	12.600	0.357
Milk, Low Fat, 1%	8.000 fl. oz.	204.958	11.565	0.129
CC - Whole Wheat Dinner Rolls	1.000 item	366.000	26.840	1.025
<b>Tuesday</b>				
Lunch		1225.485	131.001	2.843
Chicken, Breast, Casseroled, Meat Only	3.000 oz.	1225.485	131.001	2.843
Porto (Port wine)	1.000 oz.	229.631	21.262	0.936
Plantain	0.500 c.	27.499	3.118	
Composite Salad, Lettuce/Celery/Onion/Pepper	0.500 c.	360.380	26.840	0.141
Italian dressing, light	1.000 T.	135.500	7.100	0.107
Rice, Brown, Medium Grain, Cooked	0.500 c.	12.150	0.540	0.008
Crackers, Cuban	1.000 item	77.025	42.900	0.605
Milk, low fat (1%)	1.000 c.	17.300	2.600	0.023
JELLO Gelatin Mix, Lemon, Sugar Free, Low Calorie, Prepared	0.250 c.	366.000	26.840	1.025
S&W Chunky Mixed Fruit, Natural Style, Canned in Juice	0.250 c.			
<b>Wednesday</b>				
Lunch		1961.218	205.021	9.215
		1961.218	205.021	9.215

Wednesday, May 12, 2021



# Menu Template Report

Total Days: 7  
Total Foods: 67

Avg. Daily Kcals: 612.961  
Name: Miami Springs Homebound Menu B C2W2

Name	Amount Unit	Potas mg	Magn mg	Zinc mg
Beef, Ground, 97% Lean / 3% Fat, Crumbles, Pan-Browned	3,000 oz.	399,730	24,664	6,081
HUNT'S Paste, Tomato, No Salt Added	2,000 T.	330,000		
Beans, Kidney, California Red, Boiled	0,500 c.	370,815	42,480	0,761
DOLE Salad, Spinach	1,000 oz.	156,667	20,000	
Italian dressing, fat free	1,000 T.	14,726	0,722	0,052
Cornmeal, Yellow, Whole Grain	0,250 c.	87,535	38,735	0,555
Peach, Halves, Canned In Juice	0,500 c.	159,720	8,680	0,136
Rice, Brown, Medium Grain, Cooked	0,500 c.	77,025	42,900	0,605
Milk, low fat (1%)	1,000 c.	366,000	26,840	1,025
Thursday Lunch		1477,393	108,601	5,084
Chicken, Broiler, Back, Water	3,000 oz.	201,586	18,711	2,254
Chili, Meat Only, Roasted				
Sauce, Barbecue	0,500 oz.	42,740	2,133	0,029
Carrots	0,500 c.	195,200	7,320	0,146
Tomatoes, Red	2,000 fl. oz.	106,650	4,950	0,077
Onions, Red, Sliced	1,000 sl.	20,440	1,400	0,024
Broccoli	2,000 oz.	179,169	11,907	0,232
Orange	1,000 item	237,110	13,100	0,092
Macaroni and Cheese, Baked	0,500 c.	128,518	22,241	1,185
CC - Whole Wheat Dinner Rolls	1,000 item			
Milk, low fat (1%)	1,000 c.	366,000	26,840	1,026
Friday Lunch		1123,966	87,309	6,820
Milk, low fat (1%)	1,000 c.	1123,966	87,309	6,820
Composite-Pasta, Cooked	0,500 c.	20,950	12,150	0,356
Beef, Ground, 97% Lean / 3% Fat, Crumbles, Pan-Browned	2,000 oz.	266,487	16,443	4,054
Composite-Cheese, Cheddar/Colby/American/Monterey Jack	1,000 oz.	33,200	7,290	0,863

Wednesday, May 12, 2021

285



# Menu Template Report

286

Total Days: 7  
Total Foods: 67

Avg. Daily Kcals: 612,961  
Name: Miami Springs Homebound Menu B C2W2

Name	Amount Unit	Potas mg	Magn mg	Zinc mg
Vegetables, Mixed, Frozen	0.250 c.	76,320	8,640	0.162
Soup, Chicken Broth, Low Sodium, Canned	0.250 c.	51,600	0,600	0.060
Lettuce, Romaine, Shredded	0.500 c.	58,045	3,290	0.054
Salad Dressing, Caesar, Low Calorie	1.000 T.	4,350	0,300	0.017
Cantaloupe	0.500 c.	213,600	9,600	0.144
CC - Whole Wheat Dinner Rolls	1.000 item			
Garlic Powder	1.000 T.	33,404	2,156	0.084
Saturday Lunch		1256,283	109,483	4,202
Turkey, Breast, Meat and Skin, Roasted	3.000 oz.	1256,283	109,483	4,202
Gravy, Meat or Poultry, Low Sodium, Prepared	1.000 T.	244,941	22,963	1,726
Potatoes, Sweet	0.500 c.	11,947	0,295	0.147
Broccoli	0.500 c.	224,105	16,625	0.200
Sauce, Cheese	1.000 fl. oz.	143,760	9,555	0.187
Bread, Whole Wheat	1.000 item	9,450	2,835	0.309
Milk, Low Fat, 1%	1.000 fl. oz.	192,560	11,620	0.166
Sunday Lunch		63,500	18,750	0.443
Composite-Pork/Ham-All Cuts	2.000 oz.	366,000	26,840	1,025
BOAR'S HEAD Cheese, Provolone, 44% Lower Sodium	1.000 oz.	1207,035	113,229	3,857
Roll, whole wheat, hamburger bun	1.000 item	1207,035	113,229	3,857
SUNCHIPS Multigrain Snacks, Original	1.000 oz.	207,512	12,161	1,547
Lettuce, Romaine, Shredded	0.500 c.	67,760	22,680	0.479
Tomatoes, Cherry, Fresh	2.000 item	65,772	21,546	0.468
Orange, with Peel	1.000 item	58,045	3,290	0.054
Italian dressing, fat free	1.000 T.	80,580	3,740	0.058
Milk, Low Fat, 1%	8.000 fl. oz.	311,640	22,260	0.175
		14,728	0,722	0.052
		366,000	26,840	1,025



# Menu Template Nutrition Summary

Total Days: 7  
Total Foods: 73

Avg. Daily Kcals: 616.502  
Name: Miami Springs Homebound Menu B C2W3

Nutrient Goal Template: New Nutrient Goal Template

Macronutrients	Value	Unit	Goal	%	Vitamins	Value	Unit	Goal	%
Kilocalories	616.502	kcal		*	Vitamin A (RE)	469.654	RE		*
Protein	43.827	g		*	Beta-Carotene	1367.085	mcg		*
Carbohydrate	78.858	g		*	Vitamin C	54.048	mg		*
Fat, Total	13.859	g		*	Vitamin D (ug)	3.254	mcg		*
Alcohol	0.575	g		*	Vitamin E (mg)	0.171	mg		*
Cholesterol	86.952	mg		*	Vitamin E (Alpha-Tocopherol)	1.457	mg		*
Saturated Fat	5.567	g		*	Thiamin	0.715	mg		*
Monounsaturated Fat	4.802	g		*	Riboflavin	1.004	mg		*
Polyunsaturated Fat	2.099	g		*	Niacin	11.306	mg		*
MFA 18:1, Oleic	4.330	g		*	Pyridoxine (Vitamin B6)	0.986	mg		*
PFA 18:2, Linoleic	1.828	g		*	Folate (Total)	118.670	mcg		*
PFA 18:3, Linolenic	0.160	g		*	Cobalamin (Vitamin B12)	2.379	mcg		*
PFA 20:5, EPA	0.003	g		*	Biotin	7.066	mcg		*
PFA 22:6, DHA	0.006	g		*	Pantothenic Acid	2.413	mg		*
Dietary Fiber, Total	7.680	g		*	Vitamin K	21.961	mcg		*
Sugar, Total	32.787	g		*					

Amino Acids	Value	Unit	Goal	%	Minerals	Value	Unit	Goal	%
Tryptophan	404.123	mg		*	Sodium	549.163	mg		*
Threonine	1565.905	mg		*	Potassium	1402.366	mg		*
Isoleucine	1798.629	mg		*	Calcium	489.537	mg		*
Leucine	3068.402	mg		*	Iron	4.366	mg		*
Lysine	3018.828	mg		*	Phosphorus	647.732	mg		*
Methionine	952.225	mg		*	Magnesium	125.351	mg		*
Cystine	425.710	mg		*	Zinc	5.525	mg		*
Phenylalanine	1655.928	mg		*	Copper	0.381	mg		*
Tyrosine	1392.444	mg		*	Manganese	1.061	mg		*
Valine	2052.917	mg		*	Selenium	46.480	mcg		*
Histidine	1234.646	mg		*	Chromium	0.017	mg		*
					Molybdenum	12.517	mcg		*

(\* No Goal Value)

### Exchanges

Bread/Starch	2.00
Fat	0.00
Fruit	1.00
Meat-Lean	1.00
Meat-Medium Fat	0.50
Meat-Very Lean	1.50
Milk-Skim	1.00
Other Carbohydrate	0.00
Vegetables	1.00

### Percentage Of Kcals

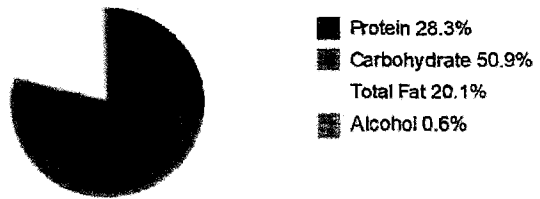



# Menu Template Report

Total Days: 7  
Total Foods: 73

Avg. Daily Kcal: 616.502  
Name: Miami Springs Homebound Menu B C2W3

Name	Amount Unit	Kcal Kcal	Protein g	Fat g	Sodium mg	Vit A (IU) IU	Vit C mg	Calcium mg	Diet Fiber g	Vit B6 mg	Vit B12 mcg
Monday		625.396	44.928	7.984	341.249	2067.178	45.259	441.117	10.654	1.083	1.455
Lunch		625.396	44.928	7.984	341.249	2067.178	45.259	441.117	10.654	1.083	1.455
Chicken, Breast, Meat Only, Boneless, Skinless, Roasted	2.500 oz.	116.942	21.985	2.530	52.447	14.884	0.000	10.631	0.000	0.425	0.241
Potatoes, Flesh and Skin, Medium	0.250 item	23.485	0.625	0.027	1.830	0.610	6.009	3.680	0.641	0.091	0.000
Olives, green	3.000 sl.	3.045	0.022	0.322	32.676	8.400	0.000	1.092	0.069	0.001	0.000
Pepper, Bell or Sweet, Green	1.000 oz.	5.670	0.244	0.048	0.850	104.893	22.793	2.835	0.482	0.064	0.000
Onions, Red, Sliced	1.000 sl.	5.600	0.154	0.014	0.560	0.000	1.036	3.220	0.238	0.017	0.000
Soup, Chicken Broth, Low Sodium, Canned	0.250 c.	9.600	1.200	0.360	18.000	0.000	0.000	2.400	0.000	0.006	0.060
Composite-Pasta, Cooked	1.000 oz.	39.317	1.333	0.187	0.279	0.000	0.000	1.955	0.422	0.010	0.000
Beans, White, Boiled	0.150 c.	37.922	2.612	0.094	1.611	0.000	0.000	24.165	1.692	0.025	0.000
Potatoes, Flesh Only, Boiled	0.200 c.	26.832	0.594	0.031	1.560	0.624	2.309	2.496	0.562	0.084	0.000
Turnip Greens	0.150 c.	2.640	0.124	0.025	3.300	955.928	4.950	15.675	0.264	0.022	0.000
Green Beans	0.400 c.	13.640	0.805	0.097	2.640	303.600	5.368	16.280	1.188	0.062	0.000
Mushrooms, White, Raw	1.000 item	3.960	0.556	0.061	0.900	0.000	0.378	0.540	0.180	0.019	0.007
BIPDS EYE Onions, White Pearl, Frozen	1.000 t.	1.029	0.018	0.001	0.420	0.000	0.000	0.311	0.036	0.000	0.000
Garlic Powder	0.500 t.	4.634	0.232	0.010	0.840	0.000	0.017	1.106	0.126	0.023	0.000
DEL MONTE Chunky Mixed Fruit, Canned in 100% Juice	0.500 c.	60.000	1.000	0.000	5.000	200.000	2.400	0.000	1.000	0.000	0.000
Rice, Brown, Medium Grain, Cooked	0.500 c.	109.200	2.262	0.809	0.975	0.000	0.000	9.750	1.755	0.145	0.000
CC - Whole Wheat Dinner Rolls	1.000 item	60.000	3.000	1.000	110.000	0.000	0.000	40.000	2.000	0.090	1.147
Milk, Low Fat, 1%	8.000 fl. oz.	102.480	8.228	2.367	107.360	478.240	0.000	305.000	0.000	0.000	2.007
Tuesday		621.815	40.084	11.735	595.557	958.400	39.000	394.010	8.823	1.163	2.007
Lunch		621.815	40.084	11.735	595.557	958.400	39.000	394.010	8.823	1.163	2.007
Pork, Shoulder and Butt, Roasted	3.000 oz.	176.191	23.753	7.807	73.871	5.467	0.778	16.169	0.000	0.429	0.816
NESTLE L1 MINOR Creole Sauce	1.000 oz.	11.340	0.421	0.315	155.072	106.878	0.000	15.876	0.369	0.032	0.000
Beans, Black, Boiled	0.250 c.	56.760	3.810	0.232	0.430	2.560	0.000	11.610	3.741	0.030	0.000
Rice, White, Medium Grain, Cooked	0.250 c.	60.450	1.107	0.098	0.000	0.000	0.000	1.395	0.140	0.023	0.000
Yuca (Yucca), Cooked	2.000 oz.	78.245	0.454	0.113	84.785	58.435	0.000	11.340	0.202	0.017	0.000
NESTLE L1 MINOR Creole Sauce	1.000 T.	6.200	0.230	0.172	84.785	58.435	0.000	8.680	0.202	0.017	0.000

Saturday, May 8, 2021

288



# Menu Template Report

289

Total Days: 7  
Total Foods: 73

Avg. Daily Kcal: 616.502  
Name: Miami Springs Homebound Menu B C2W3

Name	Amount Unit	Kcal	Protein g	Fat g	Sodium mg	Vit A (IU)	Vit C mg	Calcium mg	Diet Fiber g	Vit B6 mg	Vit B12 mcg
Banana	1.000 Item	105.020	1.286	0.389	1.180	75.520	10.266	5.900	3.068	0.433	0.000
Composite-Salad, Lettuce/Celery/Onion/Pepper	0.500 c.	18.550	0.665	0.120	14.800	220.500	27.900	13.850	1.220	0.110	0.000
Salad Dressing, Italian, Fat Free	1.000 T.	6.580	0.136	0.122	158.060	10.780	0.056	4.200	0.084	0.000	0.043
Milk, Low Fat, 1%	8.000 fl. oz.	102.480	8.223	2.367	107.360	478.240	0.000	305.000	0.000	0.090	1.147
Wednesday Lunch		593.195	46.463	11.561	501.978	5494.356	107.255	401.387	8.397	0.950	1.483
Chicken, Breast, Meat Only, Boneless, Skinless, Roasted	3.000 oz.	140.331	26.382	3.036	62.936	17.860	0.000	12.757	0.000	0.510	0.289
Marsala tipico (Marsala wine)	1.000 oz.	58.371	0.028	0.000	1.134	4.825	0.000	1.134	0.000	0.003	0.000
Quinoa, Cooked	0.500 c.	111.000	4.070	1.776	6.475	246.517	0.000	15.725	2.590	0.114	0.000
BIRDS EYE STEAMFRESH Peas, Sweet, Single Bag, Frozen	2.000 oz.	43.141	3.081	0.000	0.000	0.000	3.698	0.000	2.465	0.000	0.000
Pepper, Bell or Sweet, Red	2.000 oz.	14.742	0.561	0.170	2.268	1775.246	72.405	3.969	1.191	0.165	0.000
Salad, Mixed Baby Greens with Avugula, Butterhead, Endive, Radichio	0.500 c.	3.732	0.303	0.057	3.494	255.488	1.732	10.400	0.348	0.010	0.000
Salad Dressing, Italian, Fat Free	1.000 T.	6.580	0.136	0.122	158.060	10.780	0.056	4.200	0.084	0.000	0.043
Cantaloupe	0.500 c.	27.200	0.672	0.152	12.800	2705.600	29.360	7.200	0.720	0.058	0.000
CC - Whole Wheat Dinner Rolls	1.000 Item	60.000	3.000	1.000	110.000	0.000	0.000	40.000	2.000	0.000	0.000
Margarine-like spread, stick, salted	1.000 T.	25.619	0.006	2.881	37.451	0.000	0.005	1.002	0.000	0.000	0.003
Milk, Low Fat, 1%	8.000 fl. oz.	102.480	8.223	2.367	107.360	478.240	0.000	305.000	0.000	0.090	1.147
Thursday Lunch		600.778	36.975	10.962	788.110	1851.083	54.601	365.466	5.775	0.832	3.309
Beef, Ground, 97% Lean / 3% Fat, Loaf, Baked	3.000 oz.	600.778	36.975	10.962	788.110	1851.083	54.601	365.466	5.775	0.832	3.309
Olives, green	1.000 oz.	130.976	23.457	3.463	47.627	7.654	0.000	5.103	0.000	0.306	2.118
HUNT'S Paste, Tomato, No Salt Added	1.000 T.	41.107	0.292	4.343	441.118	113.398	0.000	14.742	0.936	0.009	0.000
Plantain	0.500 c.	15.000	0.500	0.000	10.000	150.000	1.200	0.000	1.000	0.000	0.000
Composite-Salad, Lettuce/Celery/Onion/Pepper	0.500 c.	90.280	0.962	0.259	2.960	833.980	13.616	2.220	1.258	0.179	0.000
Italian dressing, fat free	0.500 c.	18.550	0.665	0.120	14.800	220.500	27.900	13.850	1.220	0.110	0.000
Pineapple, Canned in Juice	1.000 T.	6.786	0.140	0.126	162.999	0.000	0.058	4.331	0.087	0.000	0.045
	0.500 c.	74.700	0.523	0.100	1.245	47.310	11.828	17.430	0.996	0.092	0.000





# Menu Template Report

290

Total Days: 7  
Total Foods: 73

Avg. Daily Kcals: 616.502  
Name: Miami Springs Homebound Menu B C2W3

Name	Amount Unit	Kcal	Protein g	Fat g	Sodium mg	Vit A (IU)	Vit C mg	Calcium mg	Diet Fiber g	Vit B6 mg	Vit B12 mcg
Rice, White, Medium Grain, Cooked	0.500 c.	120.900	2.213	0.195	0.000	0.000	0.000	2.790	0.279	0.047	0.000
Milk, Low Fat, 1%	8.000 fl. oz.	102.480	8.223	2.367	107.380	478.240	0.000	305.000	0.000	0.090	1.147
Friday		585.251	50.635	13.958	490.163	1109.971	20.378	522.765	6.522	0.921	2.474
Lunch		585.251	50.635	13.958	490.163	1109.971	20.378	522.765	6.522	0.921	2.474
Pork, Center Loin (Chops), Boneless, Separable Lean Only, Pan-broiled	3.000 oz.	137.779	25.532	3.955	77.395	4.252	0.000	5.103	0.000	0.326	0.536
Gravy, Meat or Poultry, Low Sodium, Prepared	1.000 oz.	15.025	1.077	0.680	5.103	0.702	0.000	1.701	0.085	0.003	0.028
Beets	0.500 c.	29.095	1.089	0.116	52.776	22.328	3.315	10.826	1.895	0.045	0.000
Potatoes, Mashed	0.500 c.	118.025	2.522	3.755	192.495	184.377	15.758	25.555	2.345	0.302	0.054
Yogurt, Greek, Plain, lowfat	3.000 oz.	62.085	8.462	1.633	28.916	262.800	0.880	97.806	0.000	0.047	0.442
Blueberries, Mixed, Thawed	1.000 oz.	12.474	0.197	0.000	0.000	46.141	0.624	4.282	0.489	0.000	0.000
Milk, Low Fat, 1%	2.000 oz.	23.814	1.911	0.550	24.948	111.130	0.000	70.874	0.000	0.021	0.266
Flour, Corn, Whole, Whole Grain	0.200 c.	84.474	1.622	0.903	1.170	0.702	0.000	1.638	1.708	0.087	0.000
Milk, Low Fat, 1%	8.000 fl. oz.	102.480	8.223	2.367	107.380	478.240	0.000	305.000	0.000	0.090	1.147
Saturday		552.276	47.878	12.845	229.565	11497.370	80.001	616.938	7.603	0.747	3.789
Lunch		552.276	47.878	12.845	229.565	11497.370	80.001	616.938	7.603	0.747	3.789
Composite-Pasta, Cooked	3.000 oz.	117.951	3.998	0.582	0.838	0.000	0.000	5.886	1.266	0.030	0.000
Beef, Ground, 97% Lean / 3% Fat, Crumbles, Pan-Browned	3.000 oz.	148.836	25.055	4.644	71.441	7.654	0.000	5.953	0.000	0.364	2.381
Cheese, Mozzarella, Low Sodium	1.000 oz.	79.380	7.796	4.848	4.536	146.570	0.000	207.239	0.000	0.023	0.261
Carrots	0.500 c.	25.070	0.567	0.146	42.090	10190.660	3.599	20.130	1.708	0.084	0.000
Green Beans	0.500 c.	17.050	1.007	0.121	3.300	379.500	6.710	20.350	1.485	0.078	0.000
Orange	1.000 item	61.570	1.231	0.157	0.000	294.750	69.692	52.400	3.144	0.079	0.000
Milk, Low Fat, 1%	8.000 fl. oz.	102.480	8.223	2.367	107.380	478.240	0.000	305.000	0.000	0.090	1.147
Sunday		736.799	39.829	27.968	897.519	1166.693	31.841	885.076	4.988	1.206	2.134
Lunch		736.799	39.829	27.968	897.519	1166.693	31.841	885.076	4.988	1.206	2.134
Composite-Pork/Ham-All Cuts	2.000 oz.	123.709	14.087	7.043	283.333	1.889	4.051	8.221	0.000	0.207	0.511
Cheese, Swiss, Low Sodium	1.000 sl.	106.029	8.051	7.768	3.969	231.903	0.000	272.444	0.000	0.023	0.476
Bread, Cuban	2.000 sl.	54.400	2.150	0.484	120.400	0.000	0.000	10.400	0.440	0.021	0.000
Chips, Plantain	1.000 oz.	150.539	0.646	8.389	57.267	392.931	9.100	2.552	0.982	0.130	0.000
Drink, Orange Juice	0.500 c.	67.230	0.249	0.000	2.490	54.780	16.675	2.490	0.249	0.623	0.000



# Menu Template Report

192

Total Days: 7  
Total Foods: 73

Avg. Daily Kcals: 816.502  
Name: Miami Springs Homebound Menu B C2W3

Name	Amount Unit	Kcal kcal	Protein g	Fat g	Sodium mg	Vit A (IU) IU	Vit C mg	Calcium mg	Diet Fiber g	Vit B6 mg	Vit B12 mcg
Bread, Whole Wheat	2.000 sl.	126.000	6.225	1.750	227.500	1.500	0.000	80.500	3.000	0.108	0.000
Mustard, Yellow	1.000 t.	3.000	0.187	0.187	55.200	5.450	0.015	3.150	0.200	0.004	0.000
Mayonnaise, fat free	1.000 t.	3.413	0.011	0.000	40.000	0.000	0.000	0.320	0.107	0.000	0.000
Milk, Low Fat, 1%	8.000 fl. oz.	102.480	8.223	2.367	107.360	478.240	0.900	305.000	0.000	0.090	1.147



# Menu Template Report

Total Days: 7  
Total Foods: 73

Avg. Daily Kcals: 616.502  
Name: Miami Springs Homebound Menu B C2W3

Name	Amount Unit	Potas mg	Magn mg	Zinc mg
<b>Monday</b>				
<b>Lunch</b>				
Chicken, Breast, Meat Only, Boneless, Skinless, Roasted	2.500 oz.	1499.458	148.814	3.411
Potatoes, Fresh and Skin, Medium	0.250 item	129.625	7.015	0.092
Olives, green	3.000 sl.	0.882	0.231	0.001
Pepper, Bell or Sweet, Green	1.000 oz.	49.612	2.835	0.037
Onions, Red, Sliced	1.000 sl.	20.440	1.400	0.024
Soup, Chicken Broth, Low Sodium, Canned	0.250 c.	51.600	0.600	0.080
Composite-Pasta, Cooked	1.000 oz.	8.670	5.028	0.148
Beans, White, Boiled	0.150 c.	150.629	16.916	0.371
Potatoes, Fresh Only, Boiled	0.200 c.	102.336	6.240	0.084
Turnip Greens	0.150 c.	24.420	2.558	0.018
Green Beans	0.400 c.	92.840	11.000	0.106
Mushrooms, White, Raw	1.000 item	57.240	1.620	0.094
BIRDS EYE Onions, White Pearl, Frozen	1.000 t.			
Garlic Powder	0.500 t.	16.702	1.078	0.042
DEL MONTE Chunky Mixed Fruit, Canned in 100% Juice	0.500 c.	170.000		
Rice, Brown, Medium Grain, Cooked	0.500 c.	77.025	42.900	0.605
CC - Whole Wheat Dinner Rolls	1.000 item	368.000	26.840	1.026
Milk, Low Fat, 1%	8.000 fl. oz.	1568.227	127.920	5.921
<b>Tuesday</b>				
<b>Lunch</b>				
Pork, Shoulder and Butt, Roasted	3.000 oz.	331.446	19.136	3.815
NESTLE LJ MINOR Creole Sauce	1.000 oz.	85.615	3.969	0.045
Beans, Black, Boiled	0.250 c.	152.650	30.100	0.482
Rice, White, Medium Grain, Cooked	0.250 c.	13.485	6.045	0.195
Yuca (Yucca), Cooked	2.000 oz.			
NESTLE LJ MINOR Creole Sauce	1.000 T.	46.810	2.170	0.025

292



# Menu Template Report

Total Days: 7  
Total Foods: 73

Avg. Daily Kcals: 616.502  
Name: Miami Springs Homebound Menu B C2W3

Name	Amount Unit	Potas mg	Magn mg	Zinc mg
Banana	1,000 item	422,440	31,860	0.177
Composite-Salad, Lettuce/Celery/Onion/Pepper	0.500 c.	135,500	7,100	0.107
Salad Dressing, Italian, Fat Free	1,000 T.	14,280	0,700	0.050
Milk, Low Fat, 1%	8,000 fl. oz.	366,000	26,840	1.025
Wednesday Lunch		1,180,890	134,678	3.324
Chicken, Breast, Meat Only, Boneless, Skinless, Roasted	3,000 oz.	217,725	24,664	0.850
Marsala tipico (Marsala wine)	1,000 oz.	27,499	3,118	
Quinoa, Cooked	0.500 c.	159,100	59,200	1.008
BIRDS EYE STEAMFRESH Peas, Sweet, Single Bag, Frozen	2,000 oz.			
Pepper, Bell or Sweet, Red	2,000 oz.	119,635	6,804	0.142
Salad, Mixed Baby Greens with Arugula, Butterhead, Endive, Radicchio	0.500 c.	61,619	3,657	0.104
Salad Dressing, Italian, Fat Free	1,000 T.	14,280	0,700	0.050
Cantaloupe	0.500 c.	213,600	9,600	0.144
CC - Whole Wheat Dinner Rolls	1,000 item			
Margarine-like spread, stick, salted	1,000 t.	1,431	0,095	0.000
Milk, Low Fat, 1%	8,000 fl. oz.	366,000	26,840	1.025
Thursday Lunch		1,505,380	112,651	7.753
Beef, Ground, 97% Lean / 3% Fat, Loaf, Baked	3,000 oz.	1505,380	112,651	7.753
Olives, green	1,000 oz.	273,007	18,711	5.902
HUNT'S Paste, Tomato, No Salt Added	1,000 T.	11,907	3,118	0.011
Plantain	0.500 c.	165,000		
Composite-Salad, Lettuce/Celery/Onion/Pepper	0.500 c.	360,380	26,640	0.141
Italian dressing, fat free	0.500 c.	135,500	7,100	0.107
Pineapple, Canned in Juice	1,000 T.	14,726	0,722	0.052
	0.500 c.	151,890	17,430	0.125

293



# Menu Template Report

Total Days: 7  
Total Foods: 73

Avg. Daily Kcals: 616.502  
Name: Miami Springs Homebound Menu B C2W3

Name	Amount Unit	Potas mg	Magn mg	Zinc mg
Rice, White, Medium Grain, Cooked	0.500 c.	26.970	12.090	0.391
Milk, Low Fat, 1%	8.000 fl. oz.	366.000	26.840	1.025
Friday		1654.805	127.796	4.622
Lunch		1654.805	127.796	4.522
Pork, Center Loin (Chops), Boneless, Separable Lean Only, Pan-broiled	3.000 oz.	346.149	22.983	1.488
Gravy, Meat or Poultry, Low Sodium, Prepared	1.000 oz.	22.963	0.567	0.283
Beets	0.500 c.	219.901	15.562	0.237
Potatoes, Mashed	0.500 c.	421.114	24.509	0.335
Yogurt, Greek, Plain, lowfat	3.000 oz.	119.918	9.355	0.510
Blueberries, Mixed, Thawed	1.000 oz.	85.049	6.237	0.238
Milk, Low Fat, 1%	2.000 oz.	73.710	21.762	0.405
Flour, Corn, White, Whole Grain	0.200 c.	386.000	26.840	1.025
Milk, Low Fat, 1%	8.000 fl. oz.	1367.034	108.130	8.808
Saturday		1367.034	108.130	8.808
Lunch		26.011	15.085	0.444
Composite-Pasta, Cooked	3.000 oz.	399.730	24.664	6.091
Beef, Ground, 97% Lean / 3% Fat, Crumbles, Pan-Browned	3.000 oz.	26.933	7.371	0.867
Cheese, Mozzarella, Low Sodium	1.000 oz.	195.200	7.320	0.146
Carrots	0.500 c.	116.050	13.750	0.132
Green Beans	0.500 c.	237.110	13.100	0.092
Orange	1.000 item	386.000	26.840	1.025
Milk, Low Fat, 1%	8.000 fl. oz.	1040.768	119.468	4.936
Sunday		1040.768	119.468	4.936
Lunch		207.512	12.151	1.547
Composite-Pork/Ham-All Cuis	2.000 oz.	31.469	10.206	1.106
Cheese, Swiss, Low Sodium	1.000 sl.	23.400	6.400	0.208
Bread, Cuban	2.000 sl.	222.831	20.129	0.105
Chips, Plain	1.000 oz.	52.290	3.735	0.025
Drink, Orange Juice	0.500 c.			

294



# Menu Template Report

Total Days: 7  
Total Foods: 73

Avg. Daily Kcals: 616.502  
Name: Miami Springs Homebound Menu B C2W3

Name	Amount Unit	Potas mg	Magn mg	Zinc mg
Bread, Whole Wheat	2.000 sl.	127.000	37.500	0.885
Mustard, Yellow	1.000 t.	7.600	2.400	0.032
Mayonnaise, fat free	1.000 t.	2.667	0.107	0.004
Milk, Low Fat, 1%	8.000 fl. oz.	366.000	26.840	1.025

295



# Menu Template Nutrition Summary

Total Days: 7  
Total Foods: 73

Avg. Daily Kcals: 656.774  
Name: Miami Springs Homebound Menu B C2W4

Nutrient Goal Template: New Nutrient Goal Template

Macronutrients	Value	Unit	Goal	%	Vitamins	Value	Unit	Goal	%
Kilocalories	656.774	kcal		*	Vitamin A (RE)	809.815	RE		*
Protein	45.276	g		*	Beta-Carotene	2988.608	mcg		*
Carbohydrate	86.243	g		*	Vitamin C	73.012	mg		*
Fat, Total	15.676	g		*	Vitamin D (ug)	3.388	mcg		*
Alcohol	0.000	g		*	Vitamin E (mg)	0.187	mg		*
Cholesterol	96.339	mg		*	Vitamin E (Alpha-Tocopherol)	2.065	mg		*
Saturated Fat	6.118	g		*	Thiamin	0.494	mg		*
Monounsaturated Fat	5.020	g		*	Riboflavin	0.974	mg		*
Polyunsaturated Fat	2.694	g		*	Niacin	10.419	mg		*
MFA 18:1, Oleic	4.145	g		*	Pyridoxine (Vitamin B6)	1.045	mg		*
PFA 18:2, Linoleic	2.227	g		*	Folate (Total)	150.640	mcg		*
PFA 18:3, Linolenic	0.250	g		*	Cobalamin (Vitamin B12)	2.441	mcg		*
PFA 20:5, EPA	0.003	g		*	Biotin	8.724	mcg		*
PFA 22:6, DHA	0.026	g		*	Pantothenic Acid	2.258	mg		*
Dietary Fiber, Total	10.605	g		*	Vitamin K	74.336	mcg		*
Sugar, Total	35.599	g		*					

Amino Acids	Value	Unit	Goal	%	Minerals	Value	Unit	Goal	%
Tryptophan	380.825	mg		*	Sodium	559.480	mg		*
Threonine	1431.037	mg		*	Potassium	1638.016	mg		*
Isoleucine	1609.110	mg		*	Calcium	573.826	mg		*
Leucine	2830.955	mg		*	Iron	4.676	mg		*
Lysine	2817.883	mg		*	Phosphorus	665.200	mg		*
Methionine	866.775	mg		*	Magnesium	137.058	mg		*
Cystine	377.173	mg		*	Zinc	5.199	mg		*
Phenylalanine	1529.137	mg		*	Copper	0.429	mg		*
Tyrosine	1296.067	mg		*	Manganese	0.970	mg		*
Valine	1845.845	mg		*	Selenium	51.373	mcg		*
Histidine	1042.005	mg		*	Chromium	0.011	mg		*
					Molybdenum	19.679	mcg		*

(\* No Goal Value)

### Exchanges

Bread/Starch	2.00
Fat	0.50
Fruit	1.50
Meat-High Fat	0.00
Meat-Lean	1.00
Meat-Medium Fat	0.50
Meat-Very Lean	1.50
Milk-Skim	1.00
Other Carbohydrate	0.00
Vegetables	1.00

### Percentage Of Kcals

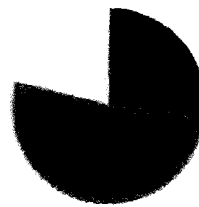

- Protein 27.1%
- Carbohydrate 51.7%
- Total Fat 21.1%
- Alcohol 0.0%

296



# Menu Template Report

297

Total Days: 7  
Total Foods: 73

AVG. Daily Kcals: 666,774  
Name: Miami Springs Homebound Menu B C2W4

Name	Amount	Unit	Kcal	Protein	Fat	Sodium	Vit A (IU)	Vit C	Calcium	Diet Fiber	Vit B6	Vit B12
			Kcal	g	g	mg	IU	mg	mg	g	mg	mcg
<b>Monday</b>												
Lunch			633,288	44,952	12,298	441,960	6212,494	14,058	399,934	12,699	1,098	2,434
Beef, Bottom Round, Select, Separable Lean and Fat, 0% Fat, Roasted	3,000	oz.	148,836	23,882	5,154	31,468	0,000	0,000	5,953	0,000	0,314	1,225
Beans, Black, Boiled	0,250	c.	56,760	3,810	0,232	0,430	2,580	0,000	11,610	3,741	0,030	0,000
Soup, Chicken Broth, Low Sodium, Canned	0,250	c.	9,600	1,200	0,360	18,000	0,000	0,000	2,400	0,000	0,006	0,060
Squash, Summer, Zucchini, with Skin, Frozen, Boiled, Drained, with Salt Added	0,250	c.	7,805	0,641	0,072	132,685	98,678	2,063	9,478	0,725	0,025	0,000
Vegetables, Mixed (Corn, Lima Beans, Peas, Green Beans, Carrots) Canned, without Salt Added	0,250	c.	16,835	0,637	0,091	11,830	5301,205	1,729	9,555	1,411	0,036	0,000
Banana	1,000	item	105,020	1,286	0,388	1,180	75,520	10,266	5,800	3,068	0,433	0,000
Rice, Brown, Medium Grain, Cooked	0,500	c.	109,200	2,262	0,809	0,975	0,000	0,000	9,750	1,755	0,145	0,000
CC - Whole Wheat Dinner Rolls	1,000	item	60,000	3,000	1,000	110,000	0,000	0,000	40,000	2,000	0,018	0,003
Margarine-like Spread, Approx 40% Fat	1,000	t.	16,752	0,011	1,823	28,032	256,272	0,000	0,288	0,000	0,018	0,003
Milk, Low Fat, 1%	8,000	fl. oz.	102,480	8,223	2,367	107,380	478,240	0,000	305,000	0,000	0,080	1,147
<b>Tuesday</b>												
Lunch			627,068	43,951	10,730	525,778	1627,250	141,411	578,385	14,375	1,419	2,868
Turkey, Breast, Meat Only, Roasted	3,000	oz.	115,667	25,098	1,675	96,956	7,654	0,000	11,907	0,000	0,706	1,497
Gravy, poultry, low sodium	1,000	T.	7,818	0,561	0,364	2,855	0,000	0,885	0,044	0,044	0,001	0,015
Yam	0,750	c.	132,750	1,721	0,191	10,125	155,250	19,238	19,125	4,613	0,380	0,000
Green Beans	0,500	c.	17,050	1,007	0,121	3,300	397,500	6,710	20,350	1,485	0,078	0,000
Orange, with Peel	1,000	item	100,170	2,067	0,477	3,180	397,500	112,890	111,300	7,155	0,148	0,000
Cornbread	2,000	oz.	144,611	4,694	5,497	214,035	171,215	1,581	96,211	0,653	0,043	0,193
Celery	1,000	oz.	4,636	0,198	0,048	22,680	37,891	0,879	11,340	0,425	0,021	0,000
Soup, Chicken Broth, Reduced Sodium, Canned	1,000	oz.	1,984	0,386	0,000	65,487	0,000	0,113	2,268	0,000	0,002	0,017
Milk, Low Fat, 1%	8,000	fl. oz.	102,480	8,223	2,367	107,360	478,240	0,000	305,000	0,000	0,090	1,147





# Menu Template Report

298

Total Days: 7  
 Total Foods: 73  
 Avg. Daily Kcal: 656.774  
 Name: Miami Springs Homebound Menu B C2W4

Name	Amount Unit	Kcal	Protein g	Fat g	Sodium mg	Vit A (IU)	Vit C mg	Calcium mg	Diet Fiber g	Vit B6 mg	Vit B12 mcg
Wednesday											
Lunch		682,536	51,068	20,511	341,081	1877,286	125,463	661,713	7,378	1,130	1,912
Chicken, Breast, Meat Only, Boneless, Skinless, Roasted	3,000 oz.	682,536	51,068	20,511	341,081	1877,286	125,463	661,713	7,378	1,130	1,912
BOAR'S HEAD Ham, Branded Deluxe, 42% Lower Sodium, Water Added	0,500 oz.	140,331	26,382	3,036	62,936	17,860	0,000	12,757	0,000	0,510	0,289
Cheese, Swiss, Low Sodium	1,000 sl.	106,029	8,051	7,768	3,969	231,903	0,000	272,444	0,000	0,023	0,476
Rice, Brown, Medium Grain, Cooked	0,500 c.	109,200	2,262	0,809	0,975	0,000	0,000	9,750	1,755	0,145	0,000
Vegetable Stir Fry (Broccoli, Beansprouts, Carrots, Peppers), Homemade	4,000 oz.	67,213	2,495	3,858	30,617	114,845	0,000	30,617	0,000	0,295	0,000
Pear, with Skin	1,000 item	97,904	0,641	0,203	1,688	39,800	7,090	15,192	5,064	0,047	0,000
FRESH EXPRESS Salad, Spinach	0,500 c.	2,500	0,250	0,000	8,125	1000,000	3,000	10,000	0,250	0,000	0,000
Cucumber	2,000 fl. oz.	3,800	0,169	0,029	0,520	27,300	0,728	4,160	0,130	0,010	0,000
Salad Dressing, French, Low Fat, without Salt Added	1,000 T.	37,979	0,095	2,194	4,890	88,183	0,000	1,793	0,179	0,009	0,000
Milk, Low Fat, 1%	8,000 fl. oz.	102,480	8,223	2,367	107,360	479,240	0,000	305,000	0,000	0,090	1,147
Thursday											
Lunch		655,714	51,892	10,775	781,403	23550,750	18,297	712,927	13,263	0,937	3,793
Composite-Pasta, Cooked	0,500 c.	95,000	3,220	0,453	0,675	0,000	0,000	4,725	1,820	0,024	0,000
Cheese, Mozzarella, nonfat or fat free	1,000 oz.	39,973	8,987	0,000	210,637	119,893	0,000	272,439	0,510	0,023	0,281
Sauce, Spaghetti Pasta, Low Sodium	0,250 c.	32,768	0,906	0,951	19,275	417,825	1,285	17,348	1,157	0,111	0,000
Beef, Ground, 97% Lean / 3% Fat, Crumbles, Pan-Browned	3,000 oz.	148,836	25,055	4,644	71,441	7,654	0,000	5,953	0,000	0,364	2,381
Carrots	1,000 c.	50,020	1,135	0,293	84,180	20361,320	7,198	40,280	3,416	0,168	0,000
Garlic Clove	0,500 item	2,235	0,095	0,008	0,255	0,135	0,468	2,715	0,032	0,019	0,000
Lettuce, Romaine, Shredded	0,500 c.	3,995	0,289	0,071	1,880	2046,850	0,940	7,765	0,494	0,017	0,000
Salad Dressing, Caesar, Low Calorie	1,000 T.	16,500	0,045	0,660	172,200	0,750	0,000	3,600	0,015	0,000	0,005
Apple, Medium	1,000 item	94,640	0,473	0,309	1,820	98,280	8,372	10,920	4,368	0,075	0,000
CC - Whole Wheat Dinner Rolls	1,000 item	60,000	3,000	1,000	110,000	0,000	0,000	40,000	2,000	0,046	0,000
Garlic Powder	1,000 l.	9,288	0,463	0,020	1,680	0,000	0,034	2,212	0,262	0,046	0,000



# Menu Template Report

Total Days: 7  
Total Foods: 73

Avg. Daily Kcal: 656.774  
Name: Miami Springs Homebound Menu B C2W4

Name	Amount Unit	Kcal kcal	Protein g	Fat g	Sodium mg	Vit A (IU)	Vit C mg	Calcium mg	Diet Fiber g	Vit B6 mg	Vit B12 mcg
Milk, Low Fat, 1%	8.000 fl. oz.	102.480	8.223	2.367	107.980	478.240	0.000	305.000	0.000	0.090	1.147
Friday		640.705	49.513	9.807	457.001	10320.440	52.077	596.094	10.576	0.821	2.554
Lunch		640.705	49.513	9.807	457.001	10320.440	52.077	596.094	10.576	0.821	2.554
Cod, Atlantic, Cooked, Dry Heat	3.000 oz.	89.301	19.417	0.731	66.938	39.973	0.850	11.907	0.000	0.241	0.893
Pepper, Bell or Sweet, Green	1.000 oz.	5.670	0.244	0.048	0.850	104.893	22.793	2.835	0.482	0.064	0.000
Onions, Chopped	1.000 oz.	11.340	0.312	0.028	1.134	0.567	2.098	6.520	0.482	0.034	0.000
Olives, green	1.000 sl.	1.015	0.007	0.107	10.892	2.800	0.000	0.364	0.023	0.000	0.000
Lentils, Boiled	0.250 c.	57.420	4.465	0.188	0.990	3.960	0.743	9.405	3.911	0.088	0.000
Soup, Chicken Broth, Low Sodium, Canned	0.250 c.	9.600	1.200	0.360	18.000	0.000	0.000	2.400	0.000	0.006	0.060
Spinach, Frozen	0.500 c.	22.620	2.831	0.445	57.720	9146.280	4.290	100.620	2.262	0.134	0.000
Rice, White, Short Grain, Cooked	0.500 c.	120.900	2.195	0.177	0.000	0.000	0.000	0.930	0.279	0.055	0.000
CC - Whole Wheat Dinner Rolls	1.000 item	60.000	3.000	1.000	110.000	0.000	0.000	40.000	2.000	0.000	0.000
Mandarin Oranges, Canned in Juice	0.250 c.	23.033	0.386	0.019	3.113	530.370	21.290	6.848	0.496	0.026	0.000
Yogurt, Greek, plain, nonfat milk	2.000 oz.	33.452	5.778	0.221	20.412	0.000	0.000	62.369	0.000	0.036	0.425
Milk, Low Fat, 1%	8.000 fl. oz.	102.480	8.223	2.367	107.980	478.240	0.000	305.000	0.000	0.090	1.147
Cookie, Oatmeal Molasses	1.000 item	103.874	1.456	4.116	60.192	13.355	0.013	46.896	0.701	0.047	0.029
Saturday		575.659	39.251	11.651	661.484	1123.263	31.643	414.671	9.177	1.313	1.672
Lunch		575.659	39.251	11.651	661.484	1123.263	31.643	414.671	9.177	1.313	1.672
Chicken, leg (drumstick and thigh), coated, baked or fried, prepared skinless, coating eaten, fat not added in cooking	3.000 oz.	139.041	21.305	4.491	398.878	0.000	0.000	19.561	0.255	0.347	0.417
Potatoes, Mashed, Garlic	4.000 oz.	81.100	2.549	0.106	12.408	34.966	14.515	32.315	2.157	0.286	0.080
Gravy, poultry, low sodium	1.000 oz.	15.025	1.077	0.680	5.103	0.000	0.000	1.701	0.085	0.003	0.028
Green Beans	0.500 c.	17.050	1.007	0.121	3.300	379.500	6.710	20.350	1.485	0.078	0.000
Onions, Chopped	0.500 l.	0.667	0.018	0.002	0.067	0.033	0.123	0.383	0.028	0.002	0.000
Butter, Spread, Vegetable Oil, Reduced Calorie	1.000 l.	20.150	0.000	2.297	25.177	155.003	0.000	0.260	0.000	0.000	0.000
Banana	1.000 item	105.020	1.286	0.389	1.180	75.520	10.266	5.900	3.068	0.433	0.000
Bread, multigrain	1.000 oz.	75.126	3.787	1.199	108.012	0.000	0.028	28.200	2.098	0.075	0.000
Milk, Low Fat, 1%	8.000 fl. oz.	102.480	8.223	2.367	107.980	478.240	0.000	305.000	0.000	0.090	1.147
Sunday		782.453	36.302	33.961	707.653	2590.140	128.138	653.061	6.770	0.599	1.852
Lunch		782.453	36.302	33.961	707.653	2590.140	128.138	653.061	6.770	0.599	1.852

299



# Menu Template Report

Total Days: 7  
Total Foods: 73

Avg. Daily Kcals: 656.774  
Name: Miami Springs Homebound Menu B C2W4

Name	Amount	Unit	Kcal	Protein	Fat	Sodium	Vit A (IU)	Vit C	Calcium	Diet Fiber	Vit B6	Vit B12
			Kcal	g	g	mg	IU	mg	mg	g	mg	mcg
Composite-Chicken/Turkey/Duck	2,000	oz.	146,256	13,907	9,637	38,709	200,840	0.114	9,797	0.000	0.181	0.475
Composite-Cheese, Cheddar/Colby/American/Montiere y Jack	1,000	oz.	110,000	6,750	8,990	226,000	231,310	0.000	196,000	0.000	0.022	0.226
Chips, Potato, Unsalted	1,000	oz.	151,956	1,985	9,809	2,288	0.000	8,817	6,804	1.361	0.187	0.000
V8 100% Juice, Vegetable, Low Sodium	5,500	fl. oz.	34,375	1,375	0.000	96,250	1,375,000	49,500	13,750	1.375	0.000	0.000
Orange Mayonnaise, reduced fat, with olive oil	1,000	Item	61,570	1,231	0.167	0.000	294,750	69,692	52,400	3.144	0.079	0.000
Mustard	1,000	fl. oz.	16,546	0.017	1,833	36,667	0.000	0.000	0.000	0.000	0.000	0.006
Milk, Low Fat, 1%	1,000	fl. oz.	3,000	0.187	0.167	55,200	0.000	0.015	3,150	0.200	0.004	0.000
Pudding, Tapioca, without Salt Added, Milk	8,000	fl. oz.	102,480	8,223	2,367	107,360	478,240	0.000	305,000	0.000	0.080	1.147
Roll, whole grain white, hamburger bun	1,000	Item	84,870	0.023	0.023	1,840	0.000	0.000	0.920	0.046	0.007	0.000
	1,000	Item	71,400	2,604	0.977	143,360	0.000	0.000	65,240	0.644	0.029	0.000

300



# Menu Template Report

301

Total Days: 7  
Total Foods: 73

Avg. Daily Kcals: 656.774  
Name: Miami Springs Homebound Menu B C2W4

Name	Amount Unit	Potas mg	Magn mg	Zinc mg
<b>Monday</b>				
Lunch		1440.422	162.580	6.783
Beef, Bottom Round, Select, Separable Lean and Fat, 0% Fat, Roasted	3.000 oz.	1440.422	162.580	6.783
Beans, Black, Boiled	0.250 c.	197.314	16.159	4.091
Soup, Chicken Broth, Low Sodium, Canned	0.250 c.	152.650	30.100	0.482
Squash, Summer, Zucchini with Skin, Frozen, Boiled, Drained, with Salt Added	0.250 c.	51.600	0.600	0.060
Vegetables, Mixed (Corn, Lima Beans, Peas, Green Beans, Carrots) Canned, without Salt Added	0.250 c.	108.155	7.248	0.112
Banana	1.000 item	62.790	6.825	0.232
Rice, Brown, Medium Grain, Cooked	0.500 c.	422.440	31.860	0.177
CC - Whole Wheat Dinner Rolls	1.000 item	77.025	42.900	0.605
Margarine-like Spread, Approx 40% Fat	1.000 t.	2.448	0.046	0.001
Milk, Low Fat, 1%	8.000 fl. oz.	386.000	26.840	1.025
<b>Tuesday</b>				
Lunch		2144.941	124.323	3.602
Turkey, Breast, Meat Only, Roasted	3.000 oz.	2144.941	124.323	3.602
Gravy, poultry, low sodium	1.000 T.	252.596	23.814	1.293
Yam	0.750 c.	11.948	0.295	0.148
Green Beans	0.500 c.	918.000	23.625	0.270
Orange, with Peel	1.000 item	116.050	13.750	0.132
Cornbread	2.000 oz.	311.640	22.280	0.175
Celery	1.000 oz.	70.903	10.337	0.501
Soup, Chicken Broth, Reduced Sodium, Canned	1.000 oz.	73.709	3.118	0.037
Milk, Low Fat, 1%	8.000 fl. oz.	24.097	0.283	0.023
<b>Wednesday, May 19, 2021</b>				
		386.000	26.840	1.025



# Menu Template Report

Total Days: 7  
Total Foods: 73

Avg. Daily Kcal: 656.774  
Name: Miami Springs Homebound Menu B C2W4

Name	Amount	Unit	Potas mg	Magn mg	Zinc mg
<b>Wednesday</b>					
<b>Lunch</b>					
Chicken, Breast, Meat Only, Boneless, Skinless, Roasted	3.000	oz.	1249.889	146.754	4.157
BOAR'S HEAD Ham, Branded	0.500	oz.	217.725	24.664	0.850
Deluxe, 42% Lower Sodium, Water Added			31.250		
Cheese, Swiss, Low Sodium	1.000	sl.	31.469	10.206	1.106
Rice, Brown, Medium Grain, Cooked	0.500	c.	77.025	42.900	0.605
Vegetable Stir Fry (Broccoli, Beansprouts, Carrots, Peppers), Homemade	4.000	oz.	269.887	18.144	0.318
Pear, with Skin	1.000	Item	200.872	11.816	0.169
FRESH EXPRESS Salad, Spinach	0.500	c.	7.500	7.500	0.052
Cucumber	2.000	fl. oz.	36.220	3.380	0.052
Salad Dressing, French, Low Fat, without Salt Added	1.000	T.	17.441	1.304	0.033
Milk, Low Fat, 1%	8.000	fl. oz.	366.000	26.840	1.026
<b>Thursday</b>					
<b>Lunch</b>					
Composite-Pasta, Cooked	0.500	c.	1708.642	114.436	9.241
Cheese, Mozzarella, nonfat or fat free	1.000	oz.	20.950	12.150	0.358
Sauce, Spaghetti Pasta, Low Sodium	0.250	c.	30.050	9.355	1.111
Beef, Ground, 97% Lean / 3% Fat, Crumbles, Pan-Browned	3.000	oz.	204.958	11.565	0.129
Carrots	3.000	oz.	399.730	24.664	6.081
Garlic Clove	1.000	c.	390.400	14.640	0.293
Lettuce, Romaine, Shredded	0.500	Item	6.015	0.375	0.017
Salad Dressing, Caesar, Low Calorie	0.500	c.	58.045	3.290	0.054
Apple, Medium	1.000	T.	4.350	0.300	0.017
CC - Whole Wheat Dinner Rolls	1.000	Item	194.740	9.100	0.073
Garlic Powder	1.000	t.	93.404	2.156	0.084

Wednesday, May 19, 2021

Page 2 of 4

302



# Menu Template Report

303

Total Days: 7  
Total Foods: 73

Avg. Daily Kcals: 656.774  
Name: Miami Springs Homebound Menu B C2W4

Name	Amount	Unit	Potas mg	Magn mg	Zinc mg
Milk, Low Fat, 1%	8.000	fl. oz.	386,000	26,840	1,025
Friday			1514,257	182,440	3,933
Lunch			1514,257	182,440	3,933
Cod, Atlantic, Cooked, Dry Heat	3.000	oz.	207,520	35,721	0,493
Pepper, Bell or Sweet, Green	1.000	oz.	49,612	2,835	0,037
Onions, Chopped	1.000	oz.	41,390	2,835	0,048
Olives, green	1.000	sl.	0,294	0,077	0,000
Lentils, Boiled	0.250	c.	182,565	17,820	0,629
Soup, Chicken Broth, Low Sodium, Canned	0.250	c.	51,600	0,600	0,060
Spinach, Frozen	0.500	c.	269,980	58,500	0,437
Rice, White, Short Grain, Cooked	0.500	c.	24,180	7,440	0,372
CC - Whole Wheat Dinner Rolls	1.000	Item			
Mandarin Oranges, Canned in Juice	0.250	c.	82,793	6,848	0,317
Yogurt, Greek, plain, nonfat milk	2.000	oz.	79,946	6,237	0,295
Milk, Low Fat, 1%	8.000	fl. oz.	366,000	26,840	1,025
Cookie, Oatmeal Molasses	1.000	Item	1598,369	137,185	4,410
Saturday			1598,369	137,185	4,410
Lunch			208,389	18,711	1,965
Chicken, leg (drumstick and thigh), coated, baked or fried, prepared skinless, cooking eaten, fat not added in cooking	3.000	oz.			
Potatoes, Maehed, Garlic	4.000	oz.	394,650	23,179	0,343
Gravy, poultry, low sodium	1.000	oz.	22,963	0,567	0,283
Green Beans	0.500	c.	116,050	13,750	0,132
Onions, Chopped	0.500	l.	2,433	0,167	0,003
Butter, Spread, Vegetable Oil, Reduced Calorie	1.000	l.	0,260	0,000	0,000
Banana	1.000	Item	422,440	31,860	0,177
Bread, multigrain	1.000	oz.	65,204	22,113	0,482
Milk, Low Fat, 1%	8.000	fl. oz.	366,000	26,840	1,025
Sunday			1809,588	91,689	4,269
Lunch			1809,588	91,689	4,269

Wednesday, May 19, 2021

Page 3 of 4



# Menu Template Report

Total Days: 7  
Total Foods: 73

Avg. Daily Kcals: 656.774  
Name: Miami Springs Homebound Menu B C2W4

Name	Amount	Unit	Potas mg	Magn mg	Zinc mg
Composite-Chicken/Turkey/Duck	2.000	oz.	129.695	11.872	1.353
Composite-Cheese, Cheddar/Colby/American/Montere y Jack	1.000	oz.	38.200	7.290	0.863
Chips, Potato, Unsalted	1.000	oz.	361.463	18.995	0.309
V8 100% Juice, Vegetable, Low Sodium	5.500	fl. oz.	618.750		
Orange	1.000	item	237.110	13.100	0.092
Mayonnaise, reduced fat, with olive oil	1.000	l.	1.421	0.092	0.003
Mustard	1.000	l.	7.800	2.400	0.032
Milk, Low Fat, 1%	8.000	fl. oz.	368.000	26.840	1.025
Pudding, Tapioca, without Salt Added, Mix	1.000	svg.	1.150	0.460	0.018
Roll, whole grain white, hamburger bun	1.000	item	53.200	10.640	0.574

304

Attestation Statement

Nutrition Provider: Miami Springs Date: 5/18/21

Registered/Licensed Dietitian's name (please print): Marvick Melendez, MS, RD, LDN, CNSC

**Instructions:**

The purpose of this form is to assist the Alliance's dietician in reviewing the menus approved by the Provider's dietician. This attestation should include discussions and steps the RD has taken with the caterer to closely follow the Dietary Guidelines.

The dietician who developed the nutrient analysis must complete **Section I** of this attestation, even if it's the Provider's caterer that developed the nutrient analysis. **Section II** must be completed by the Provider's RD only. Each page of the menu must be signed by the Provider's RD ONLY.

**SECTION I**

I attest that the attached menus have been analyzed with computer software programming using Nutritionist Pro (the name of the software). These menus meet DOEA's Computer-Assisted Menu Development requirements with the following specifics -

- Menus provide 33 1/3% of the Dietary Reference Intakes and approximately 600 calories per meal using the reference intakes for Age 70+ Females
- Analysis includes: Calories, Protein, Fat, Fiber, Calcium, Zinc, Sodium, Potassium, Magnesium, Vitamins B6, B12, C, and A
- Adequate amounts are provided daily of Calories, Protein, Fat, Fiber, Calcium, Vitamin B6 and Vitamin C
- Vitamins A and B12, Zinc, Magnesium, Sodium and Potassium are averaged over one week; however, no individual meal exceeds 1000 mg of Sodium
- These menus comply with the current Dietary Guidelines for Americans. The guidelines can be found at <http://www.health.gov/DietaryGuidelines/>

Marvick Melendez, MS, RD, LDN, CNSC  
Registered/Licensed - Signature

5/18/21  
Date

**SECTION II:**

- Menus attested to are for the following (use date and title of menus):

Miami Springs Congregate Menu B Cycle 2 effective July 19, 2021 - January 16, 2022  
Miami Springs Homebound Menu B Cycle 2 effective July 19, 2021 - January 16, 2022

- Dietitian's comments:

As requested, please refer to the attached page for a detailed list of any discrepancies found in the nutrient analysis. Note that it is very difficult to achieve 100% accuracy in nutrient analysis and that this is only an estimate of the actual nutrient composition of the meals served to seniors. When nutrients were not met to 100% of DRI's they are still close to the target (see attached). Low sodium items selected when possible.

Ronald [Signature]  
Registered/Licensed Dietitian- Signature

ND1885  
State of FL License #

RV 07/2017

305



**Miami Springs Congregate Menu B Cycle 2**

Week 1:

Weekly needs met: Potassium 1567 mg, Mg 139 mg, Zn 6 mg, vitamin A 695 RE

Week 2:

Wed 678 kcal

Weekly needs: Potassium 1396 mg (90% goal), Mg 130 mg, Zn 6 mg, Vitamin A 681 RE

Week 3:

Weekly needs met: Potassium 1481 mg (94% goal), Mg 129 mg, Zn 5 mg, Vitamin A 344 RE

Week 4:

Weekly needs met: Potassium 1533 mg (98% of goal), Mg 138 mg, Zn 5.4 mg, Vitamin A 655 RE

**Miami Springs Homebound Menu B Cycle 2**

Week 1

Sunday 790 kcal, 1121 mg sodium (low sodium items selected)

Weekly needs met: Potassium 1641 mg, Mg 133 mg, Zn 5.4 mg, Vitamin A 699 RE

Week 2:

Wed 678 kcal

Sunday 658 kcal, sodium 940 mg

Weekly needs met: Potassium 1349 mg (87% of goal), Mg 122 mg, Zn 5.2 mg, Vitamin A 713 RE

Week 3

Sunday 737 kcal, sodium 897 mg

Potassium 1402 mg (90% of goal), Mg 125 mg, Zn 5.5 mg, Vitamin A 469 RE

Week 4 Sunday 782 Kcal, sodium 708mg

Weekly nutrients met: Vitamin A 810 RE, potassium 1638 mg, Mg 137 mg, Zn 5 mg

RV 07/2017

306



# Menu Template Nutrition Summary

Total Days: 5  
Total Foods: 51

Avg. Daily Kcals: 561.006  
Name: Miami Springs Congregate Menu B C2W1

Nutrient Goal Template: New Nutrient Goal Template

Macronutrients	Value	Unit	Goal	%	Vitamins	Value	Unit	Goal	%
Kilocalories	561.006	kcal		*	Vitamin A (RE)	695.046	RE		*
Protein	40.609	g		*	Beta-Carotene	2808.589	mcg		*
Carbohydrate	74.765	g		*	Vitamin C	66.915	mg		*
Fat, Total	13.451	g		*	Vitamin D (ug)	3.137	mcg		*
Alcohol	0.000	g		*	Vitamin E (mg)	0.118	mg		*
Cholesterol	77.261	mg		*	Vitamin E (Alpha-Tocopherol)	1.870	mg		*
Saturated Fat	4.569	g		*	Thiamin	0.583	mg		*
Monounsaturated Fat	4.201	g		*	Riboflavin	0.946	mg		*
Polyunsaturated Fat	2.949	g		*	Niacin	10.390	mg		*
MFA 18:1, Oleic	3.855	g		*	Pyridoxine (Vitamin B6)	0.996	mg		*
PFA 18:2, Linoleic	2.475	g		*	Folate (Total)	135.392	mcg		*
PFA 18:3, Linolenic	0.396	g		*	Cobalamin (Vitamin B12)	2.397	mcg		*
PFA 20:5, EPA	0.001	g		*	Biotin	8.101	mcg		*
PFA 22:6, DHA	0.003	g		*	Pantothenic Acid	2.267	mg		*
Dietary Fiber, Total	10.189	g		*	Vitamin K	144.463	mcg		*
Sugar, Total	31.874	g		*					

Amino Acids	Value	Unit	Goal	%	Minerals	Value	Unit	Goal	%
Tryptophan	367.226	mg		*	Sodium	530.184	mg		*
Threonine	1390.099	mg		*	Potassium	1567.388	mg		*
Isoleucine	1541.500	mg		*	Calcium	473.527	mg		*
Leucine	2659.858	mg		*	Iron	4.607	mg		*
Lysine	2660.081	mg		*	Phosphorus	611.356	mg		*
Methionine	821.109	mg		*	Magnesium	139.525	mg		*
Cystine	342.796	mg		*	Zinc	5.677	mg		*
Phenylalanine	1464.350	mg		*	Copper	0.472	mg		*
Tyrosine	1244.488	mg		*	Manganese	1.279	mg		*
Valine	1767.470	mg		*	Selenium	39.813	mcg		*
Histidine	1042.387	mg		*	Chromium	0.013	mg		*
					Molybdenum	16.571	mcg		*

(\* No Goal Value)

### Exchanges

Bread/Starch	1.50
Fat	0.50
Fruit	1.00
Meat-Lean	0.50
Meat-Medium Fat	1.00
Meat-Very Lean	1.50
Milk-Skim	1.00
Other Carbohydrate	0.00
Vegetables	2.00

### Percentage Of Kcals

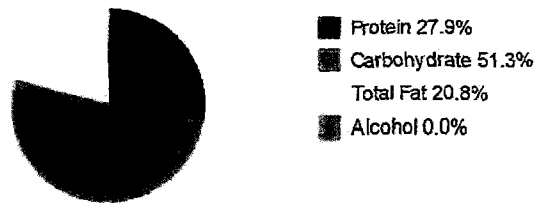

307



# Menu Template Report

208

Total Days: 5  
Total Foods: 51

Avg. Daily Kcals: 561.006  
Name: Miami Springs Congregate Menu B C2W1

Name	Amount Unit	Kcal Kcal	Protein g	Fat g	Sodium mg	Vit A (IU) IU	Vit C mg	Calcium mg	Diet Fiber g	Vit B6 mg	Vit B12 mcg
Monday		604,336	51.175	6.991	282.766	12037.350	25.180	539.554	16.339	1.371	1.524
Lunch		604,336	51.175	6.991	282.766	12037.350	25.180	539.554	16.339	1.371	1.524
Chicken, Roasting, Breast, Meat Only, Boneless, Skinless, Roasted	3.000 oz.	125.022	25.455	1.769	43.375	21.283	0.000	11.056	0.000	0.459	0.264
Juice, Lemon	1.000 fl. oz.	6.710	0.107	0.073	0.305	1.830	11.804	1.830	0.092	0.014	0.000
SPICE WORLD Garlic, Minced	1.000 t.	0.000	0.000	0.000	0.000	0.000	0.000	0.000	0.000	0.000	0.000
Beans, Kidney, California Red, Billed	3.000 oz.	105.460	7.765	0.077	3.402	2.551	1.021	56.132	7.910	0.088	0.000
Soup, Chicken Broth, Low Sodium, Canned	4.000 oz.	18.144	2.268	0.680	34.019	0.000	0.000	4.536	0.000	0.011	0.113
Spinach, Chopped, Frozen, Billed, Drained	0.500 c.	32.300	3.810	0.827	92.150	11457.950	2.090	145.350	3.515	0.129	0.000
SPICE WORLD Garlic, Minced	1.000 t.	0.000	0.000	0.000	0.000	0.000	0.000	0.000	0.000	0.000	0.000
Banana	1.000 item	105.020	1.286	0.389	1.180	75.520	10.266	5.900	3.068	0.433	0.000
Rice, Brown, Medium Grain, Cooked	0.500 c.	109.200	2.262	0.809	0.975	0.000	0.000	9.750	1.755	0.145	0.000
Milk, Low Fat, 1%	8.000 fl. oz.	102.480	8.223	2.367	107.360	478.240	0.000	305.000	0.000	0.090	1.147
Tuesday		543.487	42.666	11.701	587.654	1081.073	24.823	457.431	8.802	0.825	3.373
Lunch		543.487	42.666	11.701	587.654	1081.073	24.823	457.431	8.802	0.825	3.373
Beef, Ground, 95% Lean Meat / 5% Fat, Loaf, Baked	3.000 oz.	147.987	23.227	5.418	49.329	7.655	0.000	6.804	0.000	0.304	2.116
Gravy, beef or meat, low sodium	1.000 oz.	15.025	1.077	0.680	5.103	0.000	0.000	1.701	0.085	0.003	0.026
Potatoes, Mashed, Garlic	4.000 oz.	81.100	2.548	0.106	12.408	34.966	14.515	32.315	2.157	0.286	0.080
Green Beans	0.500 c.	17.050	1.007	0.121	3.300	379.500	6.710	20.350	1.485	0.078	0.000
Onions, Red, Sliced	1.000 oz.	11.340	0.312	0.028	1.134	0.000	2.098	6.520	0.482	0.034	0.000
JELLO Gelatin Milk, Lemon, Sugar Free, Low Calorie, Prepared	0.250 c.	12.500	0.000	0.000	150.000	0.000	0.000	0.000	0.000	0.000	0.000
Fruit Cocktail, Canned in Juice	0.250 c.	27.255	0.273	0.006	2.370	180.713	1.600	4.740	0.593	0.030	0.000
CC - Whole Wheat Dinner Rolls	2.000 item	120.000	6.000	2.000	220.000	0.000	0.000	80.000	4.000	0.000	0.000
Margarine-like spread, reduced calorie, about 20% fat, tub, salted	1.000 t.	8.750	0.000	0.975	36.650	0.000	0.000	0.000	0.000	0.000	0.000
Milk, Low Fat, 1%	8.000 fl. oz.	102.480	8.223	2.367	107.360	478.240	0.000	305.000	0.000	0.090	1.147
Wednesday		529.242	41.924	10.059	811.798	779.284	48.615	400.862	6.218	1.144	1.816
Lunch		529.242	41.924	10.059	811.798	779.284	48.615	400.862	6.218	1.144	1.816



# Menu Template Report

309

Total Days: 5  
Total Foods: 51

Avg. Daily Kcal: 561.006  
Name: Miami Springs Congregate Menu B C2W1

Name	Amount Unit	Kcal Kcal	Protein g	Fat g	Sodium mg	Vit A (IU) IU	Vit C mg	Calcium mg	Diet Fiber g	Vit B6 mg	Vit B12 mcg
Pork, Fresh, Enhanced, LoIn, Tenderloin, Separable Lean Only, Cooked, Roasted	3.000 oz.	98.656	18.379	2.679	196.462	0.000	0.000	4.252	0.000	0.519	0.400
Gravy, Au Jus, Canned	1.000 oz.	4.536	0.340	0.057	135.511	0.000	0.283	1.134	0.000	0.003	0.028
Potatoes, Red, Flesh and Skin, Baked	4.000 oz.	98.656	2.608	0.170	13.608	11.340	14.288	10.206	2.041	0.240	0.000
Bean Sprouts, Split Peas	0.250 c.	37.200	2.640	0.204	6.000	49.800	3.120	10.800	0.000	0.080	0.000
Soup, Chicken Broth, Low Sodium, Canned	4.000 oz.	18.144	2.268	0.680	34.019	0.000	0.000	4.536	0.000	0.011	0.113
Composite-Pork/Ham-All Cuts	0.500 oz.	30.927	3.522	1.761	70.833	0.472	1.013	2.055	0.000	0.052	0.128
Applesauce	4.000 oz.	46.323	0.227	0.118	2.920	18.932	2.011	7.004	0.957	0.032	0.000
CC - Whole Wheat Dinner Rolls	1.000 item	60.000	3.000	1.000	110.000	0.000	0.000	40.000	2.000	0.000	0.000
Composite-Salad, Lettuce/Celery/Onion/Pepper	0.500 c.	18.550	0.865	0.120	14.800	220.500	27.900	13.850	1.220	0.110	0.000
Italian dressing, light	1.000 T.	13.770	0.053	0.902	120.285	0.000	0.000	2.025	0.000	0.007	0.000
Milk, Low Fat, 1%	8.000 fl. oz.	102.480	8.223	2.367	107.380	478.240	0.000	305.000	0.000	0.090	1.147
Thursday Lunch		576.899	34.359	17.989	358.131	14214.610	40.707	400.983	7.446	0.864	3.707
Beef, Chuck Eye/Roast, Boneless, America's Beef Roast, All Grades, Separable Lean and Fat, 0" Fat, Roasted	3.000 oz.	200.718	20.948	13.004	64.638	18.711	0.000	15.309	0.000	0.323	2.680
Pepper, Bell or Sweet, Green	1.000 fl. oz.	3.725	0.160	0.032	0.559	68.913	14.975	1.863	0.317	0.042	0.000
Onions, Red, Sliced	1.000 fl. oz.	5.750	0.158	0.014	0.575		1.064	3.306	0.244	0.017	0.000
Pasta, Tomato, Canned, without Salt Added	1.000 T.	13.120	0.691	0.075	9.440	244.000	3.504	5.760	0.656	0.035	0.000
FRESH EXPRESS Salad, Spinach	0.500 c.	2.500	0.250	0.000	8.125	1000.000	3.000	10.000	0.250	0.000	0.000
Tomatoes, Cherry, Fresh	2.000 item	6.120	0.299	0.068	1.700		4.658	3.400	0.408	0.027	0.000
Italian dressing, light	1.000 T.	13.770	0.053	0.902	120.285	0.000	0.000	2.025	0.000	0.007	0.000
Carrots, Sliced, Frozen, Boiled, Drained	0.500 c.	27.010	0.423	0.496	43.070	12357.440	1.679	25.550	2.409	0.081	0.000
Pineapple, Canned in Juice	0.500 c.	74.700	0.523	0.100	1.245	47.310	11.828	17.430	0.996	0.092	0.000
Rice, Brown, Medium Grain, Cooked	4.000 oz.	127.006	2.631	0.941	1.134		0.000	11.340	2.166	0.169	0.000
Milk, Low Fat, 1%	8.000 fl. oz.	102.480	8.223	2.367	107.380	478.240	0.000	305.000	0.000	0.090	1.147
Friday		551.066	32.921	20.504	610.570	1675.855	195.150	568.806	12.137	0.775	1.567



# Menu Template Report

010

Total Days: 5  
Total Foods: 51

Avg. Daily Kcals: 561.006  
Name: Miami Springs Congregate Menu B C2W1

Name	Amount	Unit	Kcal	Protein	Fat	Sodium	Vit A (IU)	Vit C	Calcium	Diet Fiber	Vit B6	Vit B12
			Kcal	g	g	mg	IU	mg	mg	g	mg	mcg
Lunch												
Chicken Salad	3.000	oz.	551.066	32.921	20.504	610.570	1675.855	195.150	568.806	12.137	0.775	1.567
Soup, Chicken Broth, Low Sodium, Canned	4.000	oz.	200.715	13.429	15.088	298.520	0.000	0.680	11.907	0.340	0.235	0.111
Broccoli	2.000	oz.	18.144	2.268	0.680	34.019	0.000	0.000	4.536	0.000	0.011	0.113
Milk, Low Fat, 1%	1.000	fl. oz.	19.278	1.599	0.210	18.711	353.235	50.576	26.649	1.474	0.099	0.000
Composite-Salad, Lettuce/Celery/Onion/Pepper	0.500	c.	12.810	1.028	0.296	13.420	69.780	0.000	38.125	0.000	0.011	0.143
Tomatoes, Red	1.000	sl.	18.550	0.665	0.120	14.800	220.500	27.900	13.850	1.220	0.110	0.000
Orange, with Peel	1.000	item	3.600	0.176	0.040	1.000	166.600	2.740	2.000	0.240	0.016	0.000
Roll, whole wheat, hamburger bun	1.000	item	100.170	2.067	0.477	3.180	397.500	112.890	111.300	7.155	0.148	0.000
Milk, Low Fat, 1%	8.000	fl. oz.	75.820	3.466	1.226	119.560	0.000	0.384	55.440	1.708	0.054	0.053
			102.480	8.223	2.367	107.360	478.240	0.000	305.000	0.000	0.090	1.147



# Menu Template Report

11  
20

Total Days: 5  
Total Foods: 51

Avg. Daily Kcals: 561.006  
Name: Miami Springs Congregate Menu B C2W1

Name	Amount Unit	Potas mg	Magn mg	Zinc mg
<b>Monday</b>				
Lunch		1838.371	242.849	3.795
Chicken, Roasting, Breast, Meat Only, Boneless, Skinless, Roasted	3.000 oz.	1838.371	242.849	3.795
Juice, Lemon	1.000 fl. oz.	31.415	1.830	0.015
SPICE WORLD Garlic, Minced	1.000 t.			
Beans, Kidney, California Fed, Billed	3.000 oz.	366.353	40.823	0.731
Soup, Chicken Broth, Low Sodium, Canned	4.000 oz.	97.522	1.134	0.113
Spirnach, Chopped, Frozen, Billed, Drained	0.500 c.	286.900	77.900	0.466
SPICE WORLD Garlic, Minced	1.000 t.			
Banana	1.000 item	422.440	31.860	0.177
Rice, Brown, Medium Grain, Cooked	0.500 c.	77.025	42.800	0.605
Milk, Low Fat, 1%	8.000 fl. oz.	366.000	26.840	1.025
<b>Tuesday</b>				
Lunch		1266.498	90.079	7.720
Beef, Ground, 95% Lean Meat / 5% Fat, Loaf, Baked	3.000 oz.	1266.498	90.079	7.720
Gravy, beef or meat, low sodium	1.000 oz.	267.908	18.711	5.834
Potatoes, Mashed, Garlic	4.000 oz.	22.963	0.567	0.283
Green Beans	0.500 c.	394.650	23.178	0.343
Onions, Red, Sliced	1.000 oz.	116.050	13.750	0.132
JELLO Gelatin Milk, Lemon, Sugar Free, Low Calorie, Prepared	0.250 c.	41.390	2.835	0.048
Fruit Cocktail, Canned in Juice	0.250 c.	56.288	4.148	0.053
CC - Whole Wheat Dinner Rolls	2.000 item			
Margarine-like spread, reduced calorie, about 20% fat, tub, salted	1.000 t.	1.250	0.050	0.000
Milk, Low Fat, 1%	8.000 fl. oz.	366.000	26.840	1.025
<b>Wednesday</b>				
Lunch		1993.943	113.458	4.439
		1993.943	113.458	4.439



# Menu Template Report

3/2

Total Days: 5  
Total Foods: 51

Avg. Daily Kcals: 661.006  
Name: Miami Springs Congregate Menu B C2W1

Name	Amount Unit	Potas mg	Magn mg	Zinc mg
Pork, Fresh, Enhanced, Loin, Tenderloin, Separable Lean Only, Cooked, Roasted	3.000 oz.	482.225	21.262	1.701
Gravy, Au Jus, Canned	1.000 oz.	22.963	0.567	0.283
Potatoes, Red, Flesh and Skin, Baked	4.000 oz.	618.019	31.751	0.454
Bean Sprouts, Split Peas	0.250 c.	114.300	16.800	0.315
Soup, Chicken Broth, Low Sodium, Canned	4.000 oz.	97.522	1.134	0.113
Composite-Pork/Ham-All Cuts	0.500 oz.	51.876	3.038	0.387
Apple sauce	4.000 oz.	93.385	4.425	0.047
CC - Whole Wheat Dinner Rolls	1.000 item			
Composite-Salad, Lettuce/Celery/Onion/Pepper	0.500 c.	135.500	7.100	0.107
Italian dressing, light	1.000 T.	12.150	0.540	0.008
Milk, Low Fat, 1%	8.000 fl. oz.	366.000	26.840	1.025
Thursday Lunch		1318.140	141.005	9.535
Beef, Chuck Eye Roast, Boneless, America's Beef Roast, All Grades, Separable Lean and Fat, 0" Fat, Roasted	3.000 oz.	261.954	17.010	7.212
Pepper, Bell or Sweet, Green	1.000 fl. oz.	32.594	1.863	0.024
Onions, Red, Sliced	1.000 fl. oz.	20.988	1.438	0.024
Paste, Tomato, Canned, without Salt Added	1.000 T.	162.240	6.720	0.101
FRESH EXPRESS Salad, Spinach	0.500 c.		7.500	
Tomatoes, Cherry, Fresh	2.000 item	80.580	3.740	0.056
Italian dressing, light	1.000 T.	12.150	0.540	0.008
Carrots, Sliced, Frozen, Boiled, Drained	0.500 c.	140.160	8.030	0.256
Pineapple, Canned in Juice	0.500 c.	151.890	17.430	0.125
Rice, Brown, Medium Grain, Cooked	4.000 oz.	89.584	49.895	0.709
Milk, Low Fat, 1%	8.000 fl. oz.	366.000	26.840	1.025
Friday		1419.988	110.233	2.897



# Menu Template Report

313

Total Days: 5  
Total Foods: 51

Avg. Daily Kcals: 561.006  
Name: Miami Springs Congregate Menu B C2W1

Name	Amount	Unit	Potas mg	Magn mg	Zinc mg
Lunch					
Chicken Salad	3,000	oz.	1419.988	110.233	2.887
Soup, Chicken Broth, Low Sodium, Canned	4,000	oz.	169.247	12.757	0.604
Broccoli	2,000	oz.	97.522	1.134	0.113
Milk, Low Fat, 1%	1,000	fl. oz.	179.169	11.907	0.292
Composite-Salad, Lettuce/Celery/Onion/Pepper	0,500	c.	45.750	3.355	0.128
Tomatoes, Red	1,000	sl.	135.500	7.100	0.107
Orange, with Peel	1,000	item	47.400	2.200	0.034
Roll, whole wheat, hamburger bun	1,000	item	311.640	22.260	0.175
Milk, Low Fat, 1%	8,000	fl. oz.	67.760	22.680	0.479
			366.000	26.840	1.025





# Menu Template Nutrition Summary

Total Days: 5  
Total Foods: 50

Avg. Daily Kcals: 615.203  
Name: Miami Springs Congregate Menu B C2W2

Nutrient Goal Template: New Nutrient Goal Template

Macronutrients	Value	Unit	Goal	%	Vitamins	Value	Unit	Goal	%
Kilocalories	615.203	kcal		*	Vitamin A (RE)	681.627	RE		*
Protein	41.621	g		*	Beta-Carotene	1949.304	mcg		*
Carbohydrate	78.952	g		*	Vitamin C	51.444	mg		*
Fat, Total	15.083	g		*	Vitamin D (ug)	3.258	mcg		*
Alcohol	0.902	g		*	Vitamin E (mg)	0.293	mg		*
Cholesterol	94.903	mg		*	Vitamin E (Alpha-Tocopherol)	1.434	mg		*
Saturated Fat	6.310	g		*	Thiamin	0.474	mg		*
Monounsaturated Fat	4.944	g		*	Riboflavin	0.972	mg		*
Polyunsaturated Fat	1.885	g		*	Niacin	9.965	mg		*
MFA 18:1, Oleic	3.881	g		*	Pyridoxine (Vitamin B6)	0.698	mg		*
PFA 18:2, Linoleic	1.411	g		*	Folate (Total)	134.111	mcg		*
PFA 18:3, Linolenic	0.187	g		*	Cobalamin (Vitamin B12)	2.403	mcg		*
PFA 20:5, EPA	0.006	g		*	Biotin	4.066	mcg		*
PFA 22:6, DHA	0.007	g		*	Pantothenic Acid	1.632	mg		*
Dietary Fiber, Total	9.318	g		*	Vitamin K	65.945	mcg		*
Sugar, Total	33.641	g		*					

Amino Acids	Value	Unit	Goal	%	Minerals	Value	Unit	Goal	%
Tryptophan	270.240	mg		*	Sodium	563.016	mg		*
Threonine	1067.969	mg		*	Potassium	1396.592	mg		*
Isoleucine	1256.462	mg		*	Calcium	503.235	mg		*
Leucine	2163.558	mg		*	Iron	4.888	mg		*
Lysine	1980.714	mg		*	Phosphorus	592.190	mg		*
Methionine	627.959	mg		*	Magnesium	127.218	mg		*
Cystine	324.107	mg		*	Zinc	5.805	mg		*
Phenylalanine	1187.292	mg		*	Copper	0.371	mg		*
Tyrosine	909.211	mg		*	Manganese	0.938	mg		*
Valine	1410.916	mg		*	Selenium	46.411	mcg		*
Histidine	821.792	mg		*	Chromium	0.010	mg		*
					Molybdenum	5.901	mcg		*

(\* No Goal Value)

### Exchanges

Bread/Starch	2.00
Fat	0.50
Fruit	1.00
Meat-High Fat	0.00
Meat-Lean	2.00
Meat-Very Lean	0.00
Milk-Skim	0.00
Other Carbohydrate	0.00
Vegetables	1.50

### Percentage Of Kcals

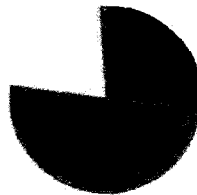

- Protein 26.7%
- Carbohydrate 50.6%
- Total Fat 21.7%
- Alcohol 1.0%

314



# Menu Template Report

Total Days: 5  
Total Foods: 60

Avg. Daily Kcals: 615.203  
Name: Miami Springs Congregate Menu B C2W2

Name	Amount	Unit	Kcal	Protein	Fat	Sodium	Vit A (IU)	Vit C	Calcium	Diet Fiber	Vit B6	Vit B12
			Kcal	g	g	mg	IU	mg	mg	g	mg	mcg

Monday			608,892	34,299	20,925	499,003	2358,129	32,450	470,556	8,425	0,522	2,402
Lunch			608,892	34,299	20,925	499,003	2358,129	32,450	470,556	8,425	0,522	2,402
Meatballs, Baked	3,000	oz.	212,875	15,662	13,660	132,890	54,439	0,295	34,298	0,424	0,123	1,256
Green Beans	0,500	c.	17,050	1,007	0,121	3,300	379,500	6,710	20,360	1,485	0,078	0,000
Almonds, Sliced	1,000	l.	11,098	0,405	0,957	0,019	0,038	0,000	5,156	0,240	0,003	0,000
Salad, Mixed Baby Greens with Anjou, Butterhead, Endive, Radicchio	0,500	c.	3,732	0,303	0,057	3,494	255,488	1,732	10,400	0,348	0,010	0,000
Italian dressing, light	1,000	T.	13,770	0,053	0,902	120,285	0,000	0,000	2,025	0,000	0,007	0,000
Mandarin Oranges or Tangerines	1,000	Item	44,520	0,680	0,280	1,680	772,800	22,428	31,080	1,512	0,086	0,000
Pasta, Spagheti, Enriched, Cooked	0,500	c.	110,600	4,060	0,651	0,700	0,000	0,000	4,900	1,280	0,034	0,000
Sauce, Spagheti Pasta, Low Sodium	2,000	fl. oz.	32,768	0,906	0,951	19,275	417,825	1,285	17,348	1,157	0,111	0,000
Milk, Low Fat, 1%	8,000	fl. oz.	102,480	8,223	2,367	107,360	478,240	0,000	305,000	0,000	0,090	1,147
CC - Whole Wheat Dinner Rolls	1,000	Item	60,000	3,000	1,000	110,000	0,000	0,000	40,000	2,000	0,846	1,147
Tuesday			588,724	36,877	9,519	481,493	1625,742	42,116	345,333	5,783	0,846	1,147
Lunch			588,724	36,877	9,519	481,493	1625,742	42,116	345,333	5,783	0,846	1,147
Chicken, Breast, Casseroled, Meat Only	3,000	oz.	136,078	24,154	4,423	51,029	0,000	0,000	7,654	0,000	0,306	0,000
Porto (Port wine)	1,000	oz.	44,366	0,028	0,000	1,134	0,000	0,000	1,134	0,000	0,003	0,000
Plantain	0,500	c.	90,280	0,962	0,269	2,960	833,980	13,616	2,220	1,256	0,179	0,000
Composite-Salad, Lettuce/Celery/Onion/Pepper	0,500	c.	18,550	0,665	0,120	14,800	220,500	27,900	13,850	1,220	0,110	0,000
Italian dressing, light	1,000	T.	13,770	0,053	0,902	120,285	0,000	0,000	2,025	0,000	0,007	0,000
Rice, Brown, Medium Grain, Cooked	0,500	c.	109,200	2,262	0,809	0,975	0,000	0,000	9,750	1,755	0,145	0,000
Crackers, Cuban	1,000	Item	21,500	0,280	0,640	22,950	0,000	0,000	3,700	0,050	0,005	0,000
Milk, low fat (1%)	1,000	c.	102,480	8,223	2,367	107,360	477,282	0,000	305,000	0,000	0,090	1,147
JELL-O Gelatin Mix, Lemon, Sugar Free, Low Calorie, Prepared	0,250	c.	12,500	0,000	0,000	150,000	0,000	0,000	0,000	0,000	0,000	0,000
S&W Chunky Mixed Fruit, Natural Style, Canned In Juice	0,250	c.	40,000	0,250	0,000	10,000	100,000	0,600	0,000	1,500	0,808	0,000
Wednesday			678,678	48,685	9,157	404,284	3986,948	15,984	419,381	16,578	0,808	3,573
Lunch			678,678	48,685	9,157	404,284	3986,948	15,984	419,381	16,578	0,808	3,573

315



# Menu Template Report

316

Total Days: 5      Avg. Daily Kcals: 615.203  
 Total Foods: 50      Name: Miami Springs Congregate Menu B CZWZ

Name	Amount Unit	Kcal	Protein g	Fat g	Sodium mg	Vit A (IU)	Vit C mg	Calcium mg	Diet Fiber g	Vit B6 mg	Vit B12 mcg
Beef, Ground, 97% Lean / 3% Fat, Crumbles, Pan-Growned	3,000 oz.	148,836	25.055	4.644	71,441	7,654	0.000	5,953	0.000	0.364	2.381
HUNT'S Paste, Tomato, No Salt Added	2,000 T.	30,000	1.000	0.000	20,000	300,000	2.400	0.000	2.000	0.000	0.000
Beans, Kidney, California Red, Botted	0,500 g.	109,740	8.080	0.080	3,540	2,655	1.082	58,410	8.231	0.092	0.000
DOLE Salad, Spinach	1,000 oz.	8,667	0.667	0.000	22,333	2666,667	8.000	26,667	0.667	0.000	0.045
Italian dressing, fat free	1,000 T.	8,786	0.140	0.126	162,899	0.000	0.058	4,331	0.087	0.000	0.000
Rice, Brown, Medium Grain, Cooked	0,500 g.	109,200	2.262	0.809	0.975	0.000	0.000	9,750	1.755	0.145	0.000
Milk, low fat (1%)	1,000 c.	102,480	8.223	2.367	107,360	471,262	0.000	305,000	0.000	0.090	1.147
Commeal, Yellow, Whole Grain	0,250 c.	110,410	2.477	1.095	10,675	65,270	0.000	1,830	2.227	0.093	0.000
Peach, Halves, Canned in Juice	0,500 c.	54,560	0.781	0.037	4,960	472,440	4.464	7,440	1.612	0.024	0.000
Thursday Lunch		640,536	46,482	18,459	715,159	12240,740	132,593	699,045	9,862	0.772	1,867
Chicken, Broiler, Back, Water Chill, Meat Only, Roasted	3,000 oz.	143,733	21.169	5.919	81,647	80,798	0.000	20,412	0.000	0.289	0.255
Sauce, Barbecue	0,500 oz.	17,887	0.219	0.042	115,971	91,733	1.513	3,671	0.040	0.016	0.002
Carrots	0,500 c.	25,010	0.567	0.146	42,090	10190,660	3.599	20,190	1.708	0.084	0.000
Tomatoes, Fed	2,000 fl. oz.	8,100	0.396	0.090	2,250	374,850	6.165	4,500	0.540	0.036	0.000
Onions, Red, Sliced	1,000 sl.	5,600	0.154	0.014	0.560	0.000	1.036	3,220	0.238	0.017	0.000
Broccoli	2,000 oz.	19,278	1.599	0.210	18,711	353,235	50,576	26,649	1.474	0.099	0.000
Orange	1,000 item	61,570	1.231	0.157	0.000	294,750	69,692	52,400	3.144	0.079	0.000
Macaroni and Cheese, Baked	0,500 c.	196,878	9.924	8.614	286,570	383,450	0.013	223,063	0.718	0.061	0.483
CC - Whole Wheat Dinner Rolls	1,000 item	60,000	3.000	1.000	110,000	0.000	0.000	40,000	2.000	0.000	0.000
Milk, low fat (1%)	1,000 c.	102,480	8.223	2.367	107,360	471,262	0.000	305,000	0.000	0.090	1.147
Friday Lunch		559,187	41,765	17,355	715,143	7288,955	34,078	581,861	5,941	0.541	3,024
Milk, low fat (1%)	1,000 c.	102,480	8.223	2.367	107,360	471,262	0.000	305,000	0.000	0.090	1.147
Composite-Pasta, Cooked	0,500 c.	95,000	3.220	0.453	0.675	0.000	0.000	4,725	1.020	0.024	0.000
Beef, Ground, 97% Lean / 3% Fat, Crumbles, Pan-Browned	2,000 oz.	99,224	16,704	3,096	47,627	5,103	0.000	3,969	0.000	0.243	1,588
Composite-Cheese, Cheddar/Colby/American/Monterey Jack	1,000 oz.	110,000	6,750	8,990	226,000	231,310	0.000	196,000	0.000	0.022	0.225



# Menu Template Report

317

Total Days: 5  
Total Foods: 50

Avg. Daily Kcals: 615.203  
Name: Miami Springs Congregate Menu B C2W2

Name	Amount Unit	Kcal Kcal	Protein g	Fat g	Sodium mg	Vit A (IU) IU	Vit C mg	Calcium mg	Diet Fiber g	Vit B6 mg	Vit B12 mcg
Vegetables, Mixed, Frozen	0.250 c.	25.920	1.189	0.187	16.920	1828.080	3.744	9.000	1.440	0.035	0.000
Soup, Chicken Broth, Low Sodium, Canned	0.250 c.	9.600	1.200	0.360	18.000		0.000	2.400	0.000	0.006	0.060
Lettuce, Romaine, Shredded Salad Dressing, Caesar, Low Calorie	0.500 c.	3.995	0.289	0.071	1.880	2046.850	0.940	7.755	0.484	0.017	0.000
Cantaloupe	1.000 T.	16.500	0.045	0.660	172.200	0.750	0.000	3.600	0.015	0.000	0.005
CC - Whole Wheat Dinner Rolls	0.500 c.	27.200	0.672	0.152	12.800	2705.600	29.360	7.200	0.720	0.058	0.000
Garlic Powder	1.000 item	60.000	3.000	1.000	110.000	0.000	0.000	40.000	2.000		
	1.000 t.	9.268	0.453	0.020	1.680	0.000	0.034	2.212	0.252	0.046	0.000



# Menu Template Report

318

Total Days: 5  
Total Foods: 50

Avg. Daily Kcals: 615.203  
Name: Miami Springs Congregate Menu B C2W2

Name	Amount Unit	Potas mg	Magn mg	Zinc mg
<b>Monday</b>				
Lunch		1194.909	104.157	5.082
Meatballs, Baked	3.000 oz.	1194.909	104.157	5.082
Green Beans	0.500 c.	249.843	19.951	3.209
Almonds, Sliced	1.000 l.	118.050	13.750	0.132
Salad, Mixed Baby Greens with Arugula, Butterhead, Endive, Radicchio	0.500 c.	14.049	5.175	0.060
Italian dressing, light	1.000 T.	61.619	3.657	0.104
Mandarin Oranges or Tangerines	1.000 item	12.150	0.540	0.008
Pasta, Spaghetti, Enriched, Cooked	0.500 c.	139.440	10.080	0.059
Sauce, Spaghetti Pasta, Low Sodium	2.000 fl. oz.	30.800	12.800	0.357
Milk, Low Fat, 1%	8.000 fl. oz.	204.958	11.565	0.129
CC - Whole Wheat Dinner Rolls	1.000 item	368.000	26.840	1.025
<b>Tuesday</b>				
Lunch		1225.485	131.001	2.843
Chicken, Breast, Casseroled, Meat Only	3.000 oz.	1225.485	131.001	2.843
Porto (Port wine)	1.000 oz.	229.631	21.262	0.936
Plantain	0.500 c.	27.499	3.118	
Composite-Salad, Lettuce/Celery/Chion/Pepper	0.500 c.	360.380	26.640	0.141
Italian dressing, light	1.000 T.	135.500	7.100	0.107
Rice, Brown, Medium Grain, Cooked	0.500 c.	12.150	0.540	0.008
Crackers, Cuban Milk, low fat (1%)	1.000 item	77.025	42.900	0.605
JELLO Gelatin Milk, Lemon, Sugar Free, Low Calorie, Prepared	1.000 c.	17.300	2.600	0.023
S&W Chunky Mixed Fruit, Natural Style, Canned In Juice	0.250 c.	366.000	26.840	1.025
<b>Wednesday</b>				
Lunch		1961.218	205.021	9.215
Lunch		1961.218	205.021	9.215



# Menu Template Report

319

Total Days: 5  
Total Foods: 50

Avg. Daily Kcals: 615.203  
Name: Miami Springs Congregate Menu B C2W2

Name	Amount Unit	Potas mg	Magn mg	Zinc mg
Beef, Ground, 97% Lean / 3% Fat, Crumbles, Pan-Browned	3,000 oz.	399,730	24,664	6,081
HUNTS Paste, Tomato, No Salt Added	2,000 T.	330,000		
Beans, Kidney, California Red, Boiled	0,500 c.	370,815	42,480	0,761
DOLE Salad, Spinach	1,000 oz.	156,667	20,000	
Italian dressing, fat free	1,000 T.	14,726	0,722	0,052
Rice, Brown, Medium Grain, Cooked	0,500 c.	77,025	42,900	0,605
Milk, low fat (1%)	1,000 c.	366,000	26,840	1,025
Corinnel, Yellow, Whole Grain	0,250 c.	87,535	38,735	0,555
Peach, Halves, Canned In Juice	0,500 c.	158,720	8,680	0,136
Thursday Lunch		1477,393	109,601	5,064
Chicken, Broiler, Back, Water Chill, Meat Only, Roasted	3,000 oz.	1477,393	108,601	5,064
Sauce, Barbecue	0,500 oz.	201,566	18,711	2,254
Carrots	0,500 c.	42,740	2,133	0,029
Tornatoes, Red	0,500 c.	195,200	7,320	0,146
Onions, Red, Sliced	2,000 fl. oz.	106,650	4,950	0,077
Broccoli	1,000 sl.	20,440	1,400	0,024
Orange	2,000 oz.	179,169	11,907	0,232
Macaroni and Cheese, Baked	1,000 item	237,110	13,100	0,092
CC - Whole Wheat Dinner Rolls	0,800 c.	128,518	22,241	1,185
Friday Lunch		1,000 c.		
Milk, low fat (1%)	1,000 c.	366,000	26,840	1,025
Milk, low fat (1%)	1,000 c.	1123,956	87,309	6,920
Milk, low fat (1%)	1,000 c.	1123,956	87,309	6,920
Composite-Pasta, Cooked	1,000 c.	366,000	26,840	1,025
Beef, Ground, 87% Lean / 3% Fat, Crumbles, Pan-Browned	0,500 c.	20,950	12,150	0,358
Composite-Cheese, Cheddar/Colby/American/Monterey Jack	2,000 oz.	266,487	16,443	4,054
Wednesday, May 12, 2021	1,000 oz.	33,200	7,290	0,863



# Menu Template Report

320

Total Days: 5  
Total Foods: 50

Avg. Daily Kcals: 615.203  
Name: Miami Springs Congregate Menu B C2W2

Name	Amount Unit	Potas mg	Magn mg	Zinc mg
Vegetables, Mixed, Frozen	0.250 c.	76.320	8.640	0.162
Soup, Chicken Broth, Low Sodium, Canned	0.250 c.	51.600	0.600	0.080
Lettuce, Romaine, Shredded	0.500 c.	58.045	3.280	0.054
Salad Dressing, Caesar, Low Calorie	1.000 T.	4.350	0.300	0.017
Cantaloupe	0.500 c.	213.600	9.600	0.144
CC - Whole Wheat Dinner Rolls	1.000 Item			
Garlic Powder	1.000 l.	33.404	2.156	0.084



# Menu Template Nutrition Summary

Total Days: 5  
Total Foods: 57

Avg. Daily Kcals: 605.287  
Name: Miami Springs Congregate Menu B C2W3

Nutrient Goal Template: New Nutrient Goal Template

Macronutrients	Value	Unit	Goal	%	Vitamins	Value	Unit	Goal	%
Kilocalories	605.287	kcal		*	Vitamin A (RE)	344.366	RE		*
Protein	43.817	g		*	Beta-Carotene	797.082	mcg		*
Carbohydrate	81.850	g		*	Vitamin C	53.298	mg		*
Fat, Total	11.240	g		*	Vitamin D (ug)	3.338	mcg		*
Alcohol	0.805	g		*	Vitamin E (mg)	0.212	mg		*
Cholesterol	85.055	mg		*	Vitamin E (Alpha-Tocopherol)	1.215	mg		*
Saturated Fat	4.020	g		*	Thiamin	0.636	mg		*
Monounsaturated Fat	4.328	g		*	Riboflavin	0.929	mg		*
Polyunsaturated Fat	1.673	g		*	Niacin	11.371	mg		*
MFA 18:1, Oleic	4.014	g		*	Pyridoxine (Vitamin B6)	0.990	mg		*
PFA 18:2, Linoleic	1.422	g		*	Folate (Total)	131.400	mcg		*
PFA 18:3, Linolenic	0.142	g		*	Cobalamin (Vitamin B12)	2.145	mcg		*
PFA 20:5, EPA	0.003	g		*	Biotin	6.704	mcg		*
PFA 22:6, DHA	0.009	g		*	Pantothenic Acid	2.522	mg		*
Dietary Fiber, Total	8.234	g		*	Vitamin K	21.353	mcg		*
Sugar, Total	33.991	g		*					

Amino Acids	Value	Unit	Goal	%	Minerals	Value	Unit	Goal	%
Tryptophan	438.570	mg		*	Sodium	543.411	mg		*
Threonine	1655.488	mg		*	Potassium	1481.752	mg		*
Isoleucine	1921.733	mg		*	Calcium	424.949	mg		*
Leucine	3241.859	mg		*	Iron	4.446	mg		*
Lysine	3218.940	mg		*	Phosphorus	624.223	mg		*
Methionine	1011.662	mg		*	Magnesium	129.972	mg		*
Cystine	438.277	mg		*	Zinc	4.986	mg		*
Phenylalanine	1750.682	mg		*	Copper	0.405	mg		*
Tyrosine	1479.862	mg		*	Manganese	1.142	mg		*
Valine	2179.359	mg		*	Selenium	52.270	mcg		*
Histidine	1310.318	mg		*	Chromium	0.017	mg		*
					Molybdenum	11.949	mcg		*

(\* No Goal Value)

### Exchanges

Bread/Starch	2.00
Fat	0.00
Fruit	1.00
Meat-Lean	1.00
Meat-Very Lean	2.00
Milk-Skim	1.50
Other Carbohydrate	0.00
Vegetables	1.00

### Percentage Of Kcals

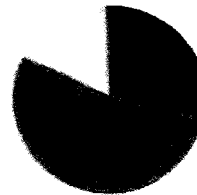

- Protein 28.8%
- Carbohydrate 53.7%
- Total Fat 16.6%
- Alcohol 0.9%





# Menu Template Report

Total Days: 5  
Total Foods: 57

Avg. Daily Kcals: 605.287  
Name: Miami Springs Congregate Menu B C2W3

Name	Amount Unit	Kcal kcal	Protein g	Fat g	Sodium mg	Vit A (IU) IU	Vit C mg	Calcium mg	Diet Fiber g	Vit B6 mg	Vit B12 mcg
Monday											
Lunch											
Chicken, Breast, Meat Only, Boneless, Skinless, Roasted	2.500 oz.	625.396	44.928	7.984	341.249	2067.178	45.259	441.117	10.654	1.083	1.455
Potatoes, Flesh and Skin, Medium	0.250 item	23.485	0.625	0.027	1.830	0.610	6.009	3.660	0.641	0.091	0.000
Olives, green	3.000 sl.	3.045	0.022	0.322	32.676	8.400	0.000	1.092	0.069	0.001	0.000
Pepper, Bell or Sweet, Green	1.000 oz.	5.670	0.244	0.048	0.850	104.893	22.793	2.835	0.482	0.064	0.000
Onions, Red, Sliced	1.000 sl.	5.600	0.154	0.014	0.560	0.000	1.036	3.220	0.238	0.017	0.000
Soup, Chicken Broth, Low Sodium, Canned	0.250 c.	9.600	1.200	0.360	18.000	0.000	0.000	2.400	0.000	0.006	0.060
Composite-Pasta, Cooked	1.000 oz.	39.317	1.333	0.187	0.279	0.000	0.000	1.955	0.422	0.010	0.000
Beans, White, Boiled	0.150 c.	37.322	2.612	0.094	1.611	0.000	0.000	24.165	1.692	0.025	0.000
Potatoes, Flesh Only, Boiled	0.200 c.	26.832	0.534	0.031	1.560	0.624	2.309	2.496	0.562	0.084	0.000
Turnip Greens	0.150 c.	2.640	0.124	0.025	3.300	955.928	4.950	15.675	0.264	0.022	0.000
Green Beans	0.400 c.	13.640	0.805	0.097	2.640	303.600	5.368	16.280	1.188	0.062	0.000
Mushrooms, White, Raw	1.000 item	3.960	0.556	0.061	0.900	0.000	0.378	0.540	0.180	0.019	0.007
BIRDS EYE Onions, White Pearl, Frozen	1.000 l.	1.029	0.018	0.001	0.420	0.000	0.000	0.311	0.036	0.000	0.000
Garlic Powder	0.500 l.	4.634	0.232	0.010	0.840	0.000	0.017	1.106	0.126	0.023	0.000
DEL MONTE Chunky Mixed Fruit, Canned in 100% Juice	0.500 c.	60.000	1.000	0.000	5.000	200.000	2.400	0.000	1.000	0.000	0.000
Rice, Brown, Medium Grain, Cooked	0.500 c.	109.200	2.262	0.809	0.975	0.000	0.000	9.750	1.755	0.145	0.000
CC - Whole Wheat Dinner Rolls	1.000 item	60.000	3.000	1.000	110.000	0.000	0.000	40.000	2.000	0.090	1.147
Milk, Low Fat, 1%	8.000 fl. oz.	102.480	8.223	2.367	107.360	478.240	0.000	305.000	0.000	0.000	2.007
Tuesday											
Lunch											
Pork, Shoulder and Butt, Roasted	3.000 oz.	821.815	40.084	11.735	595.557	958.400	39.000	394.010	8.823	1.163	2.007
NESTLE LJ MINOR Creole Sauce	1.000 oz.	178.191	29.753	7.807	73.871	5.467	0.778	16.159	0.000	0.429	0.816
Beans, Black, Boiled	0.250 c.	11.340	0.421	0.315	155.072	106.878	0.000	15.876	0.369	0.032	0.000
Rice, White, Medium Grain, Cooked	0.250 c.	56.769	3.810	0.232	0.430	2.580	0.000	11.610	3.741	0.030	0.000
Yuca (Yucca), Cooked	2.000 oz.	60.450	1.107	0.098	0.000	0.000	0.000	1.395	0.140	0.023	0.000
NESTLE LJ MINOR Creole Sauce	1.000 T.	78.245	0.454	0.119	84.785	58.435	0.000	11.340	0.202	0.017	0.000
		6.200	0.230	0.172				8.680			

322



# Menu Template Report

Total Days: 5  
Total Foods: 57

Avg. Daily Kcals: 605.267  
Name: Miami Springs Congregate Menu B C2W3

Name	Amount Unit	Kcal Kcal	Protein g	Fat g	Sodium mg	Vit A (IU) IU	Vit C mg	Calcium mg	Diet Fiber g	Vit B6 mg	Vit B12 mcg
Barrana	1,000 Item	105,020	1,286	0.389	1,180	75,520	10,266	5,900	3,068	0.433	0.000
Composite-Saled, Lettuce/Celery/Onion/Pepper	0.500 c.	18,550	0.865	0.120	14,800	220,500	27,900	13,850	1,220	0.110	0.000
Salad Dressing, Italian, Fat Free	1,000 T.	6,550	0.136	0.122	158,080	10,780	0,056	4,200	0,084	0,000	0,043
Milk, Low Fat, 1%	8,000 fl. oz.	102,480	8,223	2,367	107,360	4,78,240	0,000	305,000	0,000	0,080	1,147
Wednesday		593,195	46,463	11,561	501,978	5,494,356	107,255	401,387	9,397	0,950	1,483
Lunch		593,195	46,463	11,561	501,978	5,494,356	107,255	401,387	9,397	0,950	1,483
Chicken, Breast, Meat Only, Boneless, Skinless, Roasted	3,000 oz.	140,331	26,382	3,036	62,936	17,860	0,000	12,757	0,000	0,510	0,289
Marsala tipico (Marsala wine)	1,000 oz.	58,371	0,028	0,000	1,134	0,000	0,000	1,134	0,000	0,003	0,000
Quinoa, Cooked	0,500 c.	111,000	4,070	1,776	6,475	4,625	0,000	15,725	2,590	0,114	0,000
BIRDS EYE STEAMFRESH	2,000 oz.	43,141	3,081	0,000	0,000	246,517	3,898	0,000	2,465	0,000	0,000
Peas, Sweet, Single Bag, Frozen	2,000 oz.	14,742	0,581	0,170	2,288	1,775,246	72,405	3,969	1,191	0,165	0,000
Pepper, Bell or Sweet, Red	0,500 c.	3,732	0,303	0,057	3,494	255,488	1,732	10,400	0,348	0,010	0,000
Salad, Mixed Baby Greens with Arugula, Butterhead, Endive, Radichio											
Salad Dressing, Italian, Fat Free	1,000 T.	6,550	0,136	0,122	158,080	10,780	0,056	4,200	0,084	0,000	0,043
Carrotolupe	0,500 c.	27,200	0,672	0,152	12,800	2705,600	29,360	7,200	0,720	0,058	0,000
CC - Whole Wheat Dinner Rolls	1,000 Item	60,000	3,000	1,000	110,000	0,000	0,000	40,000	2,000	0,000	0,000
Margarine-like spread, stick, salled	1,000 t.	25,619	0,006	2,881	37,451	0,000	0,005	1,002	0,000	0,000	0,003
Milk, Low Fat, 1%	8,000 fl. oz.	102,480	8,223	2,367	107,360	4,78,240	0,000	305,000	0,000	0,080	1,147
Thursday		600,778	36,975	10,962	788,110	1,851,083	54,601	365,466	5,775	0,832	3,309
Lunch		600,778	36,975	10,962	788,110	1,851,083	54,601	365,466	5,775	0,832	3,309
Beef, Ground, 97% Lean / 3% Fat, Loaf, Baked	3,000 oz.	130,976	23,457	3,453	47,627	7,654	0,000	5,103	0,000	0,306	2,118
Olives, green	1,000 oz.	41,107	0,292	4,343	441,118	113,398	0,000	14,742	0,936	0,009	0,000
HUNTS Paste, Tomato, No Salt Added	1,000 T.	15,000	0,500	0,000	10,000	150,000	1,200	0,000	1,000	0,000	0,000
Plantain	0,500 c.	90,280	0,962	0,269	2,960	833,980	13,616	2,220	1,258	0,179	0,000
Composite-Salad, Lettuce/Celery/Onion/Pepper	0,500 c.	18,550	0,865	0,120	14,800	220,500	27,900	13,850	1,220	0,110	0,000
Italian dressing, fat free	1,000 T.	6,786	0,140	0,126	162,999	0,000	0,058	4,331	0,087	0,000	0,045
Pineapple, Canned In Juice	0,500 c.	74,700	0,523	0,100	1,245	47,310	11,828	17,430	0,996	0,092	0,000

323



# Menu Template Report

Total Days: 5  
Total Foods: 57

Avg. Daily Kcal: 605.287  
Name: Miami Springs Congregate Menu B C2W3

Name	Amount Unit	Kcal Kcal	Protein g	Fat g	Sodium mg	Vit A (IU) IU	Vit C mg	Calcium mg	Diet Fiber g	Vit B6 mg	Vit B12 mcg
Rice, White, Medium Grain, Cooked	0.500 c.	120.900	2.213	0.195	0.000	0.000	0.000	2.790	0.279	0.047	0.000
Milk, Low Fat, 1%	8.000 fl. oz.	102.480	8.223	2.387	107.360	478.240	0.000	305.000	0.000	0.090	1.147
Friday		585.251	50.635	13.968	490.163	1109.971	20.378	522.765	6.522	0.921	2.474
Lunch		585.251	50.635	13.968	490.163	1109.971	20.378	522.765	6.522	0.921	2.474
Pork, Center Loin (Chops), Boneless, Separable Lean Only, Pan-broiled	3.000 oz.	137.779	25.532	3.955	77.395	4.252	0.000	5.103	0.000	0.326	0.536
Gravy, Meat or Poultry, Low Sodium, Prepared	1.000 oz.	15.025	1.077	0.680	5.103		0.000	1.701	0.085	0.003	0.028
Beans	0.500 c.	29.095	1.089	0.115	52.776	22.328	3.315	10.826	1.895	0.045	0.000
Potatoes, Mashed	0.500 c.	118.025	2.522	3.755	192.495	184.377	15.758	25.555	2.345	0.302	0.054
Yogurt, Greek, Plain, lowfat	3.000 oz.	62.085	8.462	1.633	28.916	262.800	0.680	97.806	0.000	0.047	0.442
Blueberries, Mixed, Thawed	1.000 oz.	12.474	0.197	0.000		48.141	0.624	4.262	0.489	0.021	0.000
Milk, Low Fat, 1%	2.000 oz.	23.814	1.911	0.550	24.948	111.130	0.000	70.874	0.000	0.087	0.266
Flour, Corn, White, Whole Grain	0.200 c.	84.474	1.622	0.903	1.170	0.702	0.000	1.638	1.708	0.087	0.000
Milk, Low Fat, 1%	8.000 fl. oz.	102.480	8.223	2.367	107.360	478.240	0.000	305.000	0.000	0.090	1.147

324



# Menu Template Report

Total Days: 5  
Total Foods: 57

Avg. Daily Kcals: 605.287  
Name: Miami Springs Congregate Menu B C2W3

Name	Amount Unit	Potas mg	Magn mg	Zinc mg
<b>Monday</b>				
<b>Lunch</b>				
Chicken, Breast, Meat Only, Boneless, Skinless, Roasted	2.500 oz.	1499.458	146.814	3.411
Potatoes, Flesh and Skin, Medium	0.250 item	181.438	20.554	0.709
Olives, green	3.000 sl.	129.625	7.015	0.092
Pepper, Bell or Sweet, Green	1.000 oz.	0.882	0.231	0.001
Onions, Red, Sliced	1.000 sl.	49.612	2.835	0.037
Soup, Chicken Broth, Low Sodium, Canned	0.250 c.	20.440	1.400	0.024
Composite-Pasta, Cooked	1.000 oz.	51.800	0.600	0.060
Beans, White, Boiled	0.150 c.	8.670	5.028	0.148
Potatoes, Flesh Only, Boiled	0.200 c.	150.629	16.916	0.371
Turnip Greens	0.150 c.	102.336	6.240	0.084
Green Beans	0.400 c.	24.420	2.558	0.016
Mushrooms, White, Raw	0.400 c.	92.840	11.000	0.106
BIRDS EYE Onions, White Pearl, Frozen	1.000 t.	57.240	1.620	0.094
Garlic Powder	0.500 t.	16.702	1.078	0.042
DEL MONTE Chunky Mixed Fruit, Canned in 100% Juice	0.500 c.	170.000		
Rice, Brown, Medium Grain, Cooked	0.500 c.	77.025	42.900	0.605
CC - Whole Wheat Dinner Rolls	1.000 item	366.000	26.840	1.025
Milk, Low Fat, 1%	8.000 fl. oz.	1568.227	127.920	5.921
<b>Tuesday</b>				
<b>Lunch</b>				
Pork, Shoulder and Butt, Roasted	3.000 oz.	1568.227	127.920	5.921
NESTLE L1 MINOR Creole Sauce	1.000 oz.	331.446	19.136	3.815
Beans, Black, Boiled	0.250 c.	85.615	3.969	0.045
Rice, White, Medium Grain, Cooked	0.250 c.	152.650	30.100	0.482
Yuca (Yucca), Cooked	2.000 oz.	13.485	6.045	0.195
NESTLE L1 MINOR Creole Sauce	1.000 T.	46.810	2.170	0.025

Saturday, May 8, 2021

325



# Menu Template Report

Total Days: 5  
Total Foods: 57

Avg. Daily Kcals: 605.287  
Name: Miami Springs Congregate Menu B C2W3

Name	Amount Unit	Potas mg	Magn mg	Zinc mg
Banana	1.000 Item	422.440	31.860	0.177
Composite-Salad,	0.500 c.	135.500	7.100	0.107
Lettuce/Celery/Onion/Pepper				
Salad Dressing, Italian, Fat Free	1.000 T.	14.280	0.700	0.050
Milk, Low Fat, 1%	8.000 fl. oz.	366.000	26.840	1.025
Wednesday				
Lunch				
Chicken, Breast, Meat Only, Boneless, Skinless, Roasted	3.000 oz.	1180.890	134.678	3.324
Marsala (Marsala wine)	1.000 oz.	217.725	24.664	0.850
Quinoa, Cooked	0.500 c.	27.499	3.118	1.008
BIHDS EYE STEAM/FRESH	2.000 oz.	159.100	59.200	
Peas, Sweet, Single Bag, Frozen				
Pepper, Bell or Sweet, Red	2.000 oz.	119.635	6.804	0.142
Salad, Mixed Baby Greens with Arugula, Butterhead, Endive, Radicchio	0.500 c.	61.619	3.657	0.104
Salad Dressing, Italian, Fat Free	1.000 T.	14.280	0.700	0.050
Cantaloupe	0.500 c.	213.600	9.600	0.144
CC - Whole Wheat Dinner Rolls	1.000 Item			
Margarine-like spread, stick, salted	1.000 t.	1.431	0.095	0.000
Milk, Low Fat, 1%	8.000 fl. oz.	366.000	26.840	1.025
Thursday				
Lunch				
Beef, Ground, 97% Lean / 3% Fat, Loaf, Baked	3.000 oz.	1505.380	112.651	7.753
Olive, green	1.000 oz.	1505.380	112.651	7.753
HUNT'S Paste, Tomato, No Salt Added	1.000 T.	273.007	18.711	5.902
Plantain	0.500 c.	11.907	3.118	0.011
Composite-Salad,				
Lettuce/Celery/Onion/Pepper	0.500 c.	360.380	26.640	0.141
Italian dressing, fat free	1.000 T.	135.500	7.100	0.107
Pineapple, Canned in Juice	0.500 c.	14.726	0.722	0.052
		151.890	17.430	0.125

326



# Menu Template Report

327

Total Days: 5  
Total Foods: 57

Avg. Daily Kcals: 605,267  
Name: Miami Springs Congregate Menu B C2W3

Name	Amount Unit	Potas mg	Magn mg	Zinc mg
Rice, White, Medium Grain, Cooked	0.500 c.	26.970	12.090	0.391
Milk, Low Fat, 1%	8.000 fl. oz.	366.000	26.840	1.025
Friday		1654.805	127.796	4.522
Lunch		1654.805	127.796	4.522
Pork, Center Loin (Chops), Boneless, Separable Lean Only, Pan-broiled	3.000 oz.	346.149	22.963	1.488
Gravy, Meat or Poultry, Low Sodium, Prepared	1.000 oz.	22.963	0.567	0.288
Beets	0.500 c.	219.901	15.562	0.237
Potatoes, Mashed	0.500 c.	421.114	24.509	0.395
Yogurt, Greek, Plain, lowfat	3.000 oz.	119.918	9.355	0.510
Blueberries, Mixed, Thawed	1.000 oz.			
Milk, Low Fat, 1%	2.000 oz.	85.049	6.237	0.238
Flour, Corn, White, Whole Grain	0.200 c.	73.710	21.762	0.405
Milk, Low Fat, 1%	8.000 fl. oz.	366.000	26.840	1.025



# Menu Template Report

Total Days: 5  
Total Foods: 53

Avg. Daily Kcals: 620.588  
Name: Miami Springs Congregate Menu B C2W4

Name	Amount	Unit	Kcal	Protein	Fat	Sodium	Vit A (IU)	Vit C	Calcium	Diet Fiber	Vit B6	Vit B12
			Kcal	g	g	mg	IU	mg	mg	g	mg	mcg
<b>Monday</b>												
Lunch			833,288	44,952	12,298	441,960	6212,494	14,058	399,934	12,699	1,098	2,434
Beef, Bottom Round, Select, Separable Lean and Fat, 0" Fat, Roasted	3,000	oz.	148,836	23,882	5,154	31,468	0,000	0,000	5,953	0,000	0,314	1,225
Beans, Black, Boiled	0,250	g.	56,760	3,810	0,232	0,430	2,580	0,000	11,610	3,741	0,030	0,000
Soup, Chicken Broth, Low Sodium, Canned	0,250	g.	9,600	1,200	0,360	18,000	0,000	0,000	2,400	0,000	0,006	0,060
Squash, Summer, Zucchini, with Skin, Frozen, Boiled, Drained, with Salt Added	0,250	g.	7,805	0,641	0,072	192,685	98,678	2,063	9,478	0,725	0,025	0,000
Vegetables, Mixed (Corn, Lima Beans, Peas, Green Beans, Carrots) Canned, without Salt Added	0,250	c.	16,895	0,637	0,091	11,830	5901,205	1,729	9,555	1,411	0,036	0,000
Banana	1,000	item	105,020	1,286	0,389	1,180	75,520	10,266	5,900	3,068	0,433	0,000
Rice, Brown, Medium Grain, Cooked	0,500	g.	109,200	2,262	0,809	0,975	0,000	0,000	9,750	1,755	0,145	0,000
CC - Whole Wheat Dinner Rolls	1,000	item	60,000	3,000	1,000	110,000	0,000	0,000	40,000	2,000	0,018	0,003
Margarine-like Spread, Approx 40% Fat	1,000	t.	18,752	0,011	1,823	28,032	256,272	0,000	0,288	0,000	0,018	0,003
Milk, Low Fat, 1%	8,000	fl. oz.	102,480	8,223	2,367	107,360	478,240	0,000	305,000	0,000	0,090	1,147
<b>Tuesday</b>												
Lunch			627,066	43,951	10,730	525,778	1627,250	141,411	578,385	14,375	1,419	2,868
Turkey, Breast, Meat Only, Roasted	3,000	oz.	115,667	25,098	1,675	96,956	7,654	0,000	11,907	0,000	0,706	1,497
Gravy, poultry, low sodium	1,000	T.	7,818	0,561	0,354	2,655	0,000	0,000	0,885	0,044	0,001	0,015
Yam	0,750	c.	132,750	1,721	0,191	10,125	165,250	19,238	19,125	4,613	0,330	0,000
Green Beans	0,500	g.	17,050	1,007	0,121	3,300	379,500	6,710	20,350	1,485	0,078	0,000
Orange, with Peel	1,000	item	100,170	2,067	0,477	3,180	397,500	112,890	111,300	7,155	0,148	0,000
Cornbread	2,000	oz.	144,611	4,694	5,497	214,035	171,215	1,581	96,211	0,653	0,043	0,193
Celery	1,000	oz.	4,536	0,196	0,048	22,680	37,891	0,879	11,340	0,425	0,021	0,000
Soup, Chicken Broth, Reduced Sodium, Canned	1,000	oz.	1,984	0,386	0,000	65,487	0,000	0,113	2,268	0,000	0,002	0,017
Milk, Low Fat, 1%	8,000	fl. oz.	102,480	8,223	2,367	107,360	478,240	0,000	305,000	0,000	0,090	1,147

Saturday, May 8, 2021

328



# Menu Template Report

Total Days: 5  
Total Foods: 53

Avg. Daily Kcals: 620.568  
Name: Miami Springs Congregate Menu B C2W4

Name	Amount Unit	Kcal	Protein g	Fat g	Sodium mg	Vit A (IU)	Vit C mg	Calcium mg	Diet Fiber g	Vit B6 mg	Vit B12 mcg
<b>Wednesday</b>											
<b>Lunch</b>											
Chicken, Breast, Meal Only, Boneless, Skinless, Roasted	3.000 oz.	682.536	51.068	20.511	341.081	1877.286	125.463	661.713	7.378	1.130	1.912
BOAFT'S HEAD Ham, Branded Deluxe, 42% Lower Sodium, Water Added	0.500 oz.	140.331	26.382	3.036	62.936	17.860	0.000	12.757	0.000	0.510	0.289
Cheese, Swiss, Low Sodium	1.000 sl.	108.029	8.051	7.768	3.969	231.903	0.000	272.444	0.000	0.023	0.476
Rice, Brown, Medium Grain, Cooked	0.500 c.	109.200	2.262	0.809	0.975	0.000	0.000	9.750	1.755	0.145	0.000
Vegetable Stir-Fry (Broccoli, Beansprouts, Carrots, Peppers), Homemade	4.000 oz.	67.213	2.495	3.866	30.617	114.845	0.000	30.617	0.000	0.295	0.000
Pear, with Skin	1.000 item	97.904	0.641	0.203	1.688	33.800	7.090	15.192	5.064	0.047	0.000
FRESH EXPRESS Salad, Spinach	0.500 c.	2.500	0.250	0.000	8.125	1000.000	3.000	10.000	0.250	0.000	0.000
Cucumber	2.000 fl. oz.	3.900	0.169	0.029	0.520	27.300	0.728	4.160	0.130	0.010	0.000
Salad Dressing, French, Low Fat, without Salt Added	1.000 T.	37.979	0.095	2.194	4.890	88.183	0.000	1.793	0.179	0.009	0.000
Milk, Low Fat, 1%	8.000 fl. oz.	102.480	8.223	2.367	107.360	478.240	0.000	305.000	0.000	0.080	1.147
<b>Thursday</b>											
<b>Lunch</b>											
Composita-Pasta, Cooked	0.500 c.	630.704	51.324	10.628	739.313	13360.090	14.698	692.797	11.555	0.863	3.793
Cheese, Mozzarella, nonfat or fat free	1.000 oz.	95.000	3.220	0.453	0.675	0.000	0.000	4.725	1.020	0.024	0.000
Sauca, Spaghetti Pasta, Low Sodium	0.250 c.	32.768	0.906	0.951	19.275	417.625	1.285	17.348	1.157	0.111	0.000
Beef, Ground, 97% Lean / 3% Fat, Crumbles, Pan-Browned	3.000 oz.	148.836	26.055	4.644	71.441	7.654	0.000	5.953	0.000	0.364	2.381
Carrots	0.500 c.	25.010	0.567	0.146	42.080	10190.660	3.589	20.130	1.708	0.084	0.000
Garlic Clove	0.500 item	2.235	0.095	0.008	0.255	0.135	0.468	2.715	0.092	0.019	0.000
Lettuce, Romaine, Shredded	0.500 c.	3.995	0.289	0.071	1.880	2046.850	0.940	7.755	0.494	0.017	0.000
Salad Dressing, Caesar, Low Calorie	1.000 T.	16.500	0.045	0.660	172.200	0.750	0.000	3.600	0.015	0.000	0.005
Apple, Medium	1.000 item	94.640	0.473	0.309	1.820	98.280	8.372	10.920	4.368	0.075	0.000
CC - Whole Wheat Dinner Rolls	1.000 item	60.000	3.000	1.000	110.000	0.000	0.000	40.000	2.000	0.000	0.000
Garlic Powder	1.000 t.	9.268	0.463	0.020	1.680	0.000	0.034	2.212	0.252	0.046	0.000

Saturday, May 8, 2021

329





# Menu Template Report

Total Days: 5  
Total Foods: 53

Avg. Daily Kcals: 620.588  
Name: Miami Springs Congregate Menu B C2W4

Name	Amount Unit	Kcal Kcal	Protein g	Fat g	Sodium mg	Vit A (IU) IU	Vit C mg	Calcium mg	Diet Fiber g	Vit B6 mg	Vit B12 mcg
Milk, Low Fat, 1%	8.000 fl. oz.	102.480	8.223	2.367	107.360	478.240	0.000	305.000	0.000	0.090	1.147
Friday		529.346	45.592	11.145	480.080	3283.877	26.285	513.184	7.803	0.570	2.709
Lunch		529.346	45.592	11.145	480.080	3283.877	26.285	513.184	7.803	0.570	2.709
Tuna, White, Canned in Water, Drained, No Salt	3.000 oz.	108.862	20.088	2.526	42.524	18.159	0.000	11.907	0.000	0.185	0.995
Mayonnaise, fat free	2.000 t.	6.827	0.021	0.000	80.000	0.000	0.000	0.640	0.213	0.000	0.000
Celery, Stalk	1.000 T.	0.884	0.044	0.011	5.050	28.343	0.196	2.525	0.101	0.005	0.000
Lentils, Boiled	0.250 c.	57.420	4.465	0.188	0.990	3.980	0.743	9.405	3.911	0.088	0.000
Soup, Chicken Broth, Low Sodium, Canned	0.250 c.	9.600	1.200	0.360	18.000	0.000	0.000	2.400	0.000	0.006	0.050
Lettuce, Romaine, Shredded	0.500 c.	3.995	0.289	0.071	1.880	2046.850	0.940	7.755	0.494	0.017	0.000
Tomatoes, Red	1.000 sl.	3.600	0.176	0.040	1.000	166.800	2.740	2.000	0.240	0.016	0.000
Mandarin Oranges, Canned in Juice	0.250 c.	23.033	0.386	0.019	3.113	530.370	21.290	6.848	0.436	0.026	0.000
Yogurt, Greek, plain, nonfat milk	2.000 oz.	33.452	5.778	0.221	20.412	0.000	0.000	62.369	0.000	0.036	0.425
Roll, whole wheat, hamburger bun	1.000 item	75.320	3.466	1.226	119.560	0.000	0.364	55.440	1.708	0.054	0.053
Milk, Low Fat, 1%	8.000 fl. oz.	102.480	8.223	2.367	107.360	478.240	0.000	305.000	0.000	0.090	1.147
Cookie, Oatmeal Molasses	1.000 item	103.874	1.456	4.116	60.192	13.355	0.013	46.896	0.701	0.047	0.029

330



# Menu Template Report

331

Total Days: 5  
Total Foods: 53

Avg. Daily Kcals: 620,568  
Name: Miami Springs Congregate Menu B CZV4

Name	Amount Unit	Potas mg	Magn mg	Zinc mg
<b>Monday</b>				
Lunch		1440.422	162.580	6.783
Beef, Bottom Round, Select, Separable Lean and Fat, 0" Fat, Foasted	3.000 oz.	1440.422	162.580	6.783
Beans, Black, Boiled	0.250 c.	152.650	30.100	0.482
Soup, Chicken Broth, Low Sodium, Canned	0.250 c.	51.600	0.600	0.060
Squash, Summer, Zucchini, with Skin, Frozen, Boiled, Drained, with Salt Added	0.250 c.	108.155	7.248	0.112
Vegetables, Mixed (Corn, Lima Beans, Peas, Green Beans, Carrots) Canned, without Salt Added	0.250 c.	62.790	6.825	0.232
Banana	1.000 item	422.440	31.860	0.177
Rice, Brown, Medium Grain, Cooked	0.500 c.	77.025	42.900	0.605
CC - Whole Wheat Dinner Rolls	1.000 item			
Margarine-like Spread, Approx 40% Fat	1.000 t.	2.448	0.048	0.001
Milk, Low Fat, 1%	8.000 fl. oz.	366.000	26.840	1.025
<b>Tuesday</b>				
Lunch		2144.941	124.323	3.602
Turkey, Breast, Meat Only, Roasted	3.000 oz.	252.596	23.814	1.293
Gravy, poultry, low sodium	1.000 T.	11.948	0.295	0.148
Yam	0.750 c.	918.000	23.625	0.270
Green Beans	0.500 c.	116.050	13.750	0.192
Orange, with Peel	1.000 item	311.640	22.260	0.175
Cornbread	2.000 oz.	70.903	10.337	0.501
Celery	1.000 oz.	73.709	3.118	0.037
Soup, Chicken Broth, Reduced Sodium, Canned	1.000 oz.	24.097	0.283	0.023
Milk, Low Fat, 1%	8.000 fl. oz.	366.000	26.840	1.025



# Menu Template Report

Total Days: 5  
Total Foods: 53

Avg. Daily Kcals: 620.588  
Name: Miami Springs Congregate Menu B C2W4

Name	Amount	Unit	Potas mg	Magn mg	Zinc mg
<b>Wednesday</b>					
<b>Lunch</b>					
Chicken, Breast, Meat Only, Boneless, Skinless, Roasted	3.000	oz.	1249.889	146.754	4.157
BOAR'S HEAD Ham, Branded Deluxe, 42% Lower Sodium, Water Added	0.500	oz.	217.725	24.664	0.850
Cheese, Swiss, Low Sodium	1.000	sl.	31.469	10.206	1.106
Rice, Brown, Medium Grain, Cooked	0.500	c.	77.025	42.900	0.605
Vegetable Stir Fry (Broccoli, Beansprouts, Carrots, Peppers), Homemade	4.000	oz.	269.887	18.144	0.318
Pear, with Skin	1.000	item	200.872	11.816	0.169
FRESH EXPRESS Salad, Spinach	0.500	c.	38.220	7.500	0.062
Cucumber	2.000	fl. oz.	17.441	1.304	0.033
Salad Dressing, French, Low Fat, without Salt Added	8.000	fl. oz.	366.000	26.840	1.025
Milk, Low Fat, 1%	1.000	fl. oz.	1513.442	107.116	9.094
<b>Thursday</b>					
<b>Lunch</b>					
Composite-Pasta, Cooked	0.500	c.	1513.442	107.116	9.094
Cheese, Mozzarella, nonfat or fat free	1.000	oz.	20.950	12.150	0.358
Sauce, Spaghetti Pasta, Low Sodium	0.250	c.	30.050	9.355	1.111
Beef, Ground, 97% Lean / 3% Fat, Crumbles, Pan-Browned	3.000	oz.	204.958	11.565	0.129
Carrots	3.000	oz.	399.730	24.664	6.081
Garlic Clove	0.500	c.	195.200	7.320	0.146
Lettuce, Romaine, Shredded	0.500	c.	6.015	0.375	0.017
Salad Dressing, Caesar, Low Calorie	1.000	T.	58.045	3.290	0.054
Apple, Medium	1.000	item	4.350	0.300	0.017
CC - Whole Wheat Dinner Rolls	1.000	item	194.740	9.100	0.073
Garlic Powder	1.000	t.	33.404	2.156	0.084

Saturday, May 8, 2021

332



# Menu Template Report

Total Days: 5      Avg. Daily Kcals: 620,588  
 Total Foods: 53      Name: Miami Springs Congregate Menu B C2W4

Name	Amount Unit	Potas mg	Magn mg	Zinc mg
Milk, Low Fat, 1%	8,000 fl. oz.	386,000	26,840	1,025
Friday		1317,897	132,176	3,637
Lunch		1317,897	132,176	3,637
Tuna, White, Canned in Water, Drained, No Salt	3,000 oz.	201,565	28,066	0,408
Mayonnaise, fat free	2,000 t.	5,333	0,213	0,007
Celery, Stalk	1,000 T.	16,413	0,694	0,008
Lentils, Boiled	0,250 c.	182,655	17,820	0,629
Soup, Chicken Broth, Low Sodium, Canned	0,250 c.	51,600	0,600	0,080
Lettuce, Romaine, Shredded	0,500 c.	58,045	3,290	0,054
Tomatoes, Red	1,000 sl.	47,400	2,200	0,034
Mandarin Oranges, Canned in Juice	0,250 c.	82,793	6,848	0,317
Yogurt, Greek, plain, nonfat milk	2,000 oz.	79,946	6,237	0,295
Roll, whole wheat, hamburger bun	1,000 item	67,760	22,680	0,479
Milk, Low Fat, 1%	8,000 fl. oz.	366,000	26,840	1,025
Cookie, Oatmeal Molasses	1,000 item	158,388	16,688	0,220

333

**Price Proposal**

Tab G

137

CITY OF MIAMI SPRINGS  
REQUEST FOR PROPOSALS NO. 01-20/21

FORM 12  
PRICE PROPOSAL

THIS PRICE PROPOSAL SHALL BE SUBMITTED IN A SEPARATE, SEALED ENVELOPE THAT WILL BE OPENED AFTER THE TECHNICAL PROPOSAL IS REVIEWED, EVALUATED, AND RANKED

The Contractor agrees to furnish all labor, materials, supplies, supervision, transportation, and services necessary to furnish and deliver meals at the designated times and in the ma

Congregate Meals	Home Delivered Weekday Meals	Home Delivered Weekend Meals
\$ 3.80	\$ 5.06	\$ 4.62

Option Year Costs:

The annual base bid shall be as quoted for the initial one- year contract and shall not increase during any of the five (5) additional one (1) year option terms.

The Proposer shall provide the congregate meals, home delivered weekday meals, and home delivered weekend meals rates for each item as requested below. These prices and rates shall be all inclusive of labor, materials, supplies, supervision, transportation, and services necessary to furnish and deliver meals at the designated times and in the manner called for in these bid specifications.

Bidders must provide a detailed breakdown of each meal (average daily cost of items) in this bid submittal, as follows. (Please keep in mind that the City is exempt from sales tax.)

RAW FOOD, CONDIMENTS, DISPOSABLES, & TRANSPORTATION FEE SCHEDULE: Complete Form 12A.

The undersigned attests to his/her authority to submit this proposal and to bind the firm herein named to perform as per contract, if the firm is awarded the agreement by the City. The undersigned further certifies that he/she has read the Request for Proposal relating to this request and this proposal is submitted with full knowledge and understanding of the requirements and time constraints noted herein.

By signing this form, the proposer hereby declares that this proposal is made without collusion with any other person or entity submitting a proposal pursuant to this RFP.

Firm: Greater Miami Caterers, Inc.

Authorized Signature: 

Print or Type Name: John Olmo

Title: Vice-President

Date: 06/10/21

CITY OF MIAMI SPRINGS  
REQUEST FOR PROPOSALS NO. 01-20/21

FORM 12A  
Unit Fee Schedule

RAW FOOD COSTS	Congregate Meals	Home Delivered Weekday Meals	Home Delivered Weekend Meals
Entrée (Meat or Alternative)	\$ 0.96	\$ 0.96	\$ 0.96
Vegetable	0.27	0.27	0.27
Fruit	0.25	0.25	0.25
Salad	0.27	0.27	0.27
Grain (Bread or Substitute)	0.14	0.14	0.14
Butter/Margarine	0.01	0.01	0.01
Dessert	0.25	0.25	0.25
Beverage: Milk	0.28	0.28	0.28
Juice (Not on Menu)	—	—	—
<b>TOTAL RAW FOOD COSTS:</b>	<b>2.43</b>	<b>2.43</b>	<b>2.43</b>

CONDIMENT COSTS (Included in raw Food costs)	Congregate Meals	Home Delivered Weekday Meals	Home Delivered Weekend Meals
Ketchup	—	—	—
Mustard	—	—	—
Salt	—	—	—
Salad Dressing	—	—	—
Pepper	—	—	—
<b>TOTAL CONDIMENT COSTS:</b>	<b>—</b>	<b>—</b>	<b>—</b>

**CITY OF MIAMI SPRINGS  
REQUEST FOR PROPOSALS NO. 01-20/21**

<b>DISPOSABLES COSTS<sup>1</sup></b>	<b>Congregate Meals</b>	<b>Home Delivered Weekday Meals</b>	<b>Home Delivered Weekend Meals</b>
Paper or Styrofoam Tray	0.095	—	—
Cutlery (In packet kit)	0.055	0.055	0.055
Napkin(s)	in kit	in kit	in kit
Cup(s)	0.031	0.035	0.035
Bowl(s)	0.02	0.03	0.03
Straw(s)	in kit	in kit	in kit
Aluminum Pan(s)	0.14	—	—
Home Delivery Tray(s) with Lid(s)	—	0.17	0.17
<b>TOTAL DISPOSABLES COSTS:</b>	<b>0.341</b>	<b>0.29</b>	<b>0.29</b>

<b>TRANSPORTATION COSTS</b>	<b>Congregate Meals</b>	<b>Home Delivered Weekday Meals</b>	<b>Home Delivered Weekend Meals</b>
Vehicle Amortization	0.035	0.105	0.053
Maintenance Inspection Insurance Depreciation	0.056	0.32	0.16
<b>TOTAL TRANSPORTATION COSTS:</b>	<b>0.091</b>	<b>0.425</b>	<b>0.213</b>

<sup>1</sup> Bidders must provide samples of proposed disposables and packaging with this bid submittal. Paper towels and table coverings to be provided by the City.



CITY OF MIAMI SPRINGS  
REQUEST FOR PROPOSALS NO. 01-20/21

	Congregate Meals	Home Delivered Weekday Meals	Home Delivered Weekend Meals
TOTAL FOOD PREP. COSTS:	0.271	0.632	0.632
TOTAL EQUIPMENT COSTS:	—	—	—

OTHER COSTS (Please provide description for each)	Congregate Meals	Home Delivered Weekday Meals	Home Delivered Weekend Meals
Delivery Personnel	0.197	0.775	0.547
Rent, utilities, Administrative fees, Bank Fees, Computer Technologies, etc	0.356	0.356	0.356
Depreciation, Licenses Pest Control, Professional Fees, Repairs & Maintenance, Security, Kitchen Supplies, Trash Removal and uniforms			

	Congregate Meals	Home Delivered Weekday Meals	Home Delivered Weekend Meals
PROFITS:	0.114	0.152	0.152
TOTALS:	\$ 3.80	\$ 5.06	\$ 4.62



# AGENDA MEMORANDUM

**Meeting Date:** June 28, 2021

**To:** The Honorable Mayor Maria Puente Mitchell and Members of the City Council

**Via:** William Alonso, City Manager/Finance Director

**From:** Armando Guzman, Chief of Police *Armando Guzman 6/18/2021*

**Subject:** Stationary Automated License Plate Reader w/Software and Accessories

**Recommendation:** Recommendation by the Police Department that Council approve an expenditure to General Sales Administration (T/A Major Police Supply), utilizing GSA Contract Number: GS-07F-0115Y in the amount of \$30,260.00, for one stationary automated license plate reader with software and extended warranty, as these funds were approved in the FY20/21 Budget pursuant to Section §31.11 (E)(5) of the City Code.

**Discussion/Analysis:** Purchase one stationary automated license plate reader (to be installed at S. Royal Poinciana Blvd. / East Dr.) with software. ALPR data can help the Police Department develop and pursue leads in criminal investigations by assisting in locating suspects, witnesses, and victims by identifying vehicles in the vicinity. See attached Letter and Quote from General Sales Administration.

**Submission Date and Time:** 6/18/2021 10:38 AM

<u>Submitted by:</u>	<u>Approved by (sign as applicable):</u>	<u>Funding:</u>
<b>Department:</b> <u>Police Department</u> <b>Prepared by:</b> <u>Ariadna Quintana <i>apq</i></u> <b>Attachments:</b> <input checked="" type="checkbox"/> Yes <input type="checkbox"/> No <b>Budgeted/Funded</b> <input checked="" type="checkbox"/> Yes <input type="checkbox"/> No	<b>Dept. Head:</b> <i>Armando Guzman 6/18/2021</i> <b>Procurement:</b> _____ <b>Asst. City Mgr.:</b> _____ <b>City Manager:</b> _____	<b>Dept./ Desc.:</b> <u>Police Machinery &amp; Equipment</u> <b>Account No.:</b> <u>001-2001-521.64-00</u> <b>Additional Funding:</b> <u>N/A</u> <b>Amount previously approved:</b> \$ <u>N/A</u> <b>Current request:</b> \$ <u>30,260.00</u> <b>Total vendor amount:</b> \$ <u>30,260.00</u>

**RESOLUTION NO. 2021-\_\_\_\_**

**A RESOLUTION OF THE MAYOR AND CITY COUNCIL OF THE CITY OF MIAMI SPRINGS, FLORIDA, APPROVING THE PURCHASE OF A STATIONARY AUTOMATED LICENSE PLATE READER AND EXTENDED MAINTENANCE AGREEMENT FROM GENERAL SALES ADMINISTRATION, INC. D/B/A MAJOR POLICE SUPPLY IN AN AMOUNT NOT TO EXCEED BUDGETED FUNDS UTILIZING THE TERMS AND CONDITIONS OF THE UNITED STATES GENERAL SERVICES ADMINISTRATION COOPERATIVE PURCHASING AGREEMENT PURSUANT TO SECTION 31-11(E)(5) OF THE CITY CODE; PROVIDING FOR AUTHORIZATION; PROVIDING FOR IMPLEMENTATION; AND PROVIDING FOR AN EFFECTIVE DATE.**

**WHEREAS**, on October 10, 2016, the City of Miami Springs (the “City”) Council approved the purchase of a stationary (two-camera) automated license plate reader and software from General Sales Administration, Inc. d/b/a Major Police Supply (the “Contractor”) utilizing contract number GS-35F-0574X, a competitively bid contract from the United States General Services Administration (the “GSA”), in the amount of \$36,153.24, for use at the intersection of Curtiss Parkway and Canal Street; and

**WHEREAS**, the City is in need of an additional automated license plate reader at the intersection of South Royal Poinciana Boulevard and East Drive for the City’s Police Department (the “Department”) to continue providing services for the safety of the City’s residents and visitors, facilitate the provision of day-to-day operations of the Department, and assist the Department with developing and pursuing leads in criminal investigations by locating suspects, witnesses, and victims by identifying vehicles in the vicinity; and

**WHEREAS**, the type of automated license plate reader needed by the City has been competitively bid by the GSA, which awarded contract number GS-07F-0115Y to the Contractor (the “GSA Contract”); and

**WHEREAS**, Section 31-11(E)(5) of the City’s Code of Ordinances (the “Code”) provides that purchases of supplies, materials, or contractual services under the provisions of state or local government, or private sector cooperative purchasing or

not-for-profit companies, bids or contracts shall be exempt from the competitive bid requirements otherwise applicable to such purchases; and

**WHEREAS**, the Contractor has provided the quote attached hereto as Exhibit “A” (the “Quote”) for the purchase and installation of one stationary, automated license plate reader at the intersection of South Royal Poinciana Boulevard and East Drive (the “Equipment”); and

**WHEREAS**, the Contractor’s Quote includes a two-year parts and labor warranty and provides the option for the City to enter into an Extended Maintenance Agreement for an extended three year warranty and on-site support associated with the Equipment at the reduced cost of \$1,500 per year (i.e., \$4,500 total), when purchased at the time of the Equipment is purchased (the “Extended Maintenance Agreement”); and

**WHEREAS**, the Contractor’s Quote for \$30,260, includes the purchase and installation of the Equipment, as well as the reduced cost of the first year of the extended three-year warranty pursuant to an Extended Maintenance Agreement; and

**WHEREAS**, in accordance with Section 31-11(E)(5) of the City’s Code, the City Council seeks to authorize the City Manager to purchase the Equipment from the Contractor consistent with the terms and conditions of the Quote attached hereto as Exhibit “A” and the GSA Contract; enter into a construction agreement, in a form approved by the City Attorney as to form, content, and legal sufficiency, for the construction related to the Equipment; enter into an Extended Maintenance Agreement at the reduced cost of \$1,500 per year (i.e., \$4,500 total); and expend budgeted funds in an amount not to exceed \$33,260, of which \$30,260 may be expended as previously budgeted during Fiscal Year 2020-2021 and up to \$1,500 per fiscal year may be expended, if budgeted, during Fiscal Years 2023-2024 and 2024-2025; and

**WHEREAS**, the City Council finds that this Resolution is in the best interest and welfare of the residents of the City.

**NOW, THEREFORE, BE IT RESOLVED BY THE MAYOR AND CITY COUNCIL OF THE CITY OF MIAMI SPRINGS, FLORIDA, AS FOLLOWS:**

**Section 1. Recitals.** That the above recitals are confirmed, adopted, and incorporated herein and made a part hereof by reference.

**Section 2. Approval.** That the City Council hereby approves the purchase of the Equipment and Extended Maintenance Agreement pursuant to Section 31-11(E)(5) of the City Code.

**Section 3. Authorization.** That the City Council hereby authorizes the City Manager to purchase the Equipment from the Contractor consistent with the terms and conditions of the Quote attached hereto as Exhibit "A" and the GSA Contract; enter into a construction agreement, in a form approved by the City Attorney as to form, content, and legal sufficiency, for the construction related to the Equipment; and to expend budgeted funds in an amount not to exceed \$30,260. The City Manager is further authorized to enter into an Extended Maintenance Agreement at the reduced cost of \$1,500 per year (i.e., \$4,500 total). The cost of the first year of the Extended Maintenance Agreement has been included in the up-front \$30,260 purchase of the Equipment, as reflected in the Quote attached hereto as Exhibit "A." Accordingly, if budgeted, the City Manager may expend up to \$1,500 per fiscal year during Fiscal Years 2023-2024 and 2024-2025 for the Extended Maintenance Agreement.

**Section 4. Implementation.** That the City Manager, Chief of Police, and City Attorney are hereby authorized to take such further action as may be necessary to implement the purpose and provisions of this Resolution.

**Section 5. Effective Date.** That this Resolution shall be effective immediately upon adoption.

The foregoing Resolution was offered by \_\_\_\_\_ who moved its adoption. The motion was seconded by \_\_\_\_\_ and upon being put to a vote, the vote was as follows:

Vice Mayor Bob Best	_____
Councilwoman Jacky Bravo	_____
Councilwoman Dr. Walter Fajet	_____
Councilman Dr. Victor Vazquez	_____
Mayor Maria Puente Mitchell	_____

PASSED AND ADOPTED this 28<sup>th</sup> day of June, 2021.

---

MARIA PUENTE MITCHELL  
MAYOR

ATTEST:

---

ERIKA GONZALEZ, MMC  
CITY CLERK

APPROVED AS TO FORM AND LEGAL SUFFICIENCY  
FOR THE USE AND RELIANCE OF THE CITY OF MIAMI SPRINGS ONLY:

---

WEISS SEROTA HELFMAN COLE & BIERMAN, P.L.  
CITY ATTORNEY



**General Sales Administration**  
**T/A Major Police Supply**  
**Kenvil, NJ 07847**  
**Phone (800) 666-4472 Fax (973) 584-5022**

6/1/2021

Miami Springs Police Department  
201 Westward Drive  
Miami Springs, FL 33166

**REF: Equipment and Construction for the following locations:**  
**1. S. Royal Poinciana Blvd. @ East Drive**

~~2. Sunrise Parkway @ NW 30th Street~~

**GSA Contract Number: GS-07F-0115Y**

Captain Deal,

Major Police Supply is pleased to provide you with this quote for the equipment and construction required to complete these 2 sites on your ALPR schedule.

Key points about PIPS Neology in the ALPR market:

- For more than 25 years, PIPS has **only** focused on Automatic License Plate Recognition technologies.
- As an Original Equipment Manufacturer, PIPS designs, manufactures, and develops their own hardware and software – we control the quality and support of our products from start to finish.
- PIPS offers an ALPR “back-end” analysis software package (BOSS) that provides data-mining of “historic” license plate information obtained and stored from all deployed mobile (and fixed) systems within your department.
- PIPS has two patents:
  - **PlateFinder** – Identifies license plates based on reflective properties and physical size of plates, which reduces false triggers (mailboxes, picket fences, street signs, etc.).
  - **TripleFlash** – Varies flash, shutter and gain settings to capture multiple images per vehicle, ensuring a quality image over a wide range of ambient and environmental conditions.

**Purchase Order #1**

**Site #1**  
**S. Poinciana Blvd. and East Drive**

**Single Camera System**

Qty.	SIN	Stock No.	Description	Cost	Extended Cost
1	334220	FC5812550000	<b><u>P500 2.5k sensor 810nm Ethernet Only</u></b> – P520 2.5k Integrated ANPR Camera, Illuminator and Processor all in one unit; this ALPR Unit captures multiple license plates in the same field of view.	\$8,206.55	\$8,206.55
1	334220	75-0302-5461-1	<b><u>TBOX 1-48V 1 P500</u></b> 48V P500 Single camera termination box with single power supply, and lightning protection circuitry. Two extra spaces for modem and Interface board.	\$906.80	\$906.80
1	336320	HW52X0011	<b><u>Pole Mounting Bracket with Pole Strap</u></b> - All in one fixed camera bracket.	\$365.44	\$365.44
1	336320	HC350244L010	<b><u>P52X Cables- 10m Ethernet cable &amp; 10m Power &amp; Serial Cable.</u></b>	\$375.14	\$375.14
<b>Sub-total (GSA scheduled items)</b>					<b>\$9,853.93</b>

**Site #2**  
**Curtiss Parkway and NW 36<sup>th</sup> Street**

**Dual Camera System**

Qty.	SIN	Stock No.	Description	Cost	Extended Cost
2	334220	FC5812550000	<b><u>P500 2.5k sensor 810nm Ethernet Only</u></b> – P520 2.5k Integrated ANPR Camera, Illuminator and Processor all in one unit; this ALPR Unit captures	\$8,206.55	\$16,413.10



			multiple license plates in the same field of view.		
1	334220	75-0302-5461-1	<b>TBOX 2-48V 2 P500</b> 48V P500 Dual camera termination box with dual power supplies, and lightning protection circuitry. Two extra spaces for modem and Interface board.	\$1,314.86	\$1,314.86
2	336320	HW52X0011	<b>Pole Mounting Bracket with Pole Strap</b> - All in one fixed camera bracket.	\$365.44	\$730.88
2	336320	HC350244L010	<b>P52X Cables- 10m Ethernet cable &amp; 10m Power &amp; Serial Cable.</b>	\$375.14	\$750.28
<b>Sub-total (GSA scheduled items)</b>					<b>\$19,209.12</b>

#### GSA – Open Market Items

Contracting Officer / Purchasing Manager Instructions – Note these as separate “Open Market Items” on your Purchase Order

Item #	Qty	Equipment and Software Purchase Order #1	Cost	Extended Cost
1	2	Digi Transport 4G Modem for Sprint network with external antenna.	\$1,250.00	\$2,500.00
2	3	MPS Commissioning: Commissioning, aiming, and IT configuration for initial single intersection.	\$1,200.00	\$3,600.00
<b>SubTotal - Open Market Items</b>				<b>\$6,100.00</b>

**Purchase Order #2**

**Site #1**  
**S. Poinciana Blvd. and East Drive**

**Construction**

<b>Item #</b>	<b>Qty</b>	<b>Construction Costs Purchase Order #2</b>	<b>List Item Cost</b>
1	1	Turnkey construction to include electrical materials, 6" wide iron pole, pole painting, equipment rental, trench ditch under NEC for electrical pipes, 1 1/2" PVC pipes schedule 40 installation, supply power to NEMA box, ALPR camera and NEMA box installation, 4G access point installation, testing, configuration support, coordination, taxes, and permits.	\$15,856.00
<b>SubTotal</b>			<b>\$15,856.00</b>

**Site #2**

~~**Garland Parkway and NW 36<sup>th</sup> Street**~~

**Construction**

<b>Item #</b>	<b>Qty</b>	<b>Construction Costs Purchase Order #2</b>	<b>List Item Cost</b>
1	1	Turnkey construction to include electrical materials, 6" wide iron pole, pole painting, equipment rental, trench ditch under NEC for electrical pipes, 1 1/2" PVC pipes schedule 40 installation, supply power to NEMA box, ALPR camera and NEMA box installation, 4G access point installation, testing, configuration support, coordination, taxes, and permits.	\$16,856.00
<b>SubTotal</b>			<b>\$16,856.00</b>

## Payment terms:

All equipment noted as PO #1 are considered as equipment and will be invoiced net 30 after equipment is received by Miami Springs Police Department.

All equipment noted as PO #2 are considered as construction and will be invoiced as follows:

At time of initial PO, 50% of construction amount is due.

At completion of rough construction, 25% of construction amount is due.

At completion of final inspections, 25% of construction amount is due.

**NOTE:** All PIPS equipment hardware and software is covered by a two-year parts and labor warranty. Major Police Supply offers an extended maintenance plan after the second year expires. This maintenance plan will extend your current hardware warranty for an additional year or years, plus include on-site support.

Extended maintenance agreements can be purchased at the time of purchase, or at any point prior to the expiration of the two-year warranty period. The extended maintenance can be purchased for years 3, 4 and 5. Maintenance agreements cannot be extended beyond the 5<sup>th</sup> year, as the ALPR system has an end-of-life cycle at five years.

If the extended maintenance is purchased at the time of purchase, the cost is \$1,500 per year, or \$4,500 for years 3, 4 and 5.

If the extended maintenance is purchased after the time of purchase the cost is \$2,000 per year, or \$6,000 for years 3, 4 and 5.

Extended maintenance- priced per system per year.	Unit Cost
<b>MPS_Maintenance_now</b> - At time of purchase.	\$1,500.00
[REDACTED]	[REDACTED]
[REDACTED]	[REDACTED]

Please let me know if you have any questions or require any additional information.

Best Regards,

Michael Hinchcliff  
Technology Sales Manager  
**Major Police Supply**  
Phone: 443-844-9715  
Email: mhinchcliff@majorpolicesupply.com

**Location**

<b>#1 - S. Poinciana Blvd. / East Dr.</b>	2 Camera		
	1 Camera	\$9,853.93	
	Modem	\$1,250.00	
	Commissioning	\$1,800.00	
	Construction	\$15,856.00	
	Extended Warranty for fixed ALPR - \$1,500 per year	\$1,500.00	
<b>Total - Options</b>		<b>\$30,259.93</b>	

**GENERAL SERVICES ADMINISTRATION  
FEDERAL ACQUISITION SERVICE  
AUTHORIZED FEDERAL SUPPLY SCHEDULE CATALOG/PRICE LIST**

On-line access to contract ordering information, terms and conditions, up-to-date pricing, and the option to create an electronic delivery order is available through **GSA Advantage!**, a menu-driven database system. The INTERNET address for **GSA Advantage!** is <http://www.gsaadvantage.gov>

**SCHEDULE TITLE:** Sch 84- TOTAL SOLUTIONS FOR LAW ENFORCEMENT, SECURITY, FACILITIES MANAGEMENT, FIRE, RESCUE, CLOTHING, MARINE CRAFT AND EMERGENCY/DISASTER RESPONSE

**FSC GROUP:** FSC 84

**CONTRACT NUMBER:** GS-07F-0115Y

**CONTRACT PERIOD:** November 23, 2016- November 22, 2021

For more information on ordering from Federal Supply Schedules click on the **GSA Schedules link** at [www.gsa.gov](http://www.gsa.gov)

**CONTRACTOR:**



**General Sales Administration, Inc dba Major Police Supply**  
47 N Dell Ave, Ste 5  
Kenvil, NJ 07847  
Phone number: 800-666-4472  
Fax number: 973-584-5022  
[www.majorpolicesupply.com](http://www.majorpolicesupply.com)

**CONTRACTOR'S ADMINISTRATION SOURCE:** Steve Markiewicz  
[smarkiewicz@majorpolicesupply.com](mailto:smarkiewicz@majorpolicesupply.com)

**BUSINESS SIZE:** Small

**CUSTOMER INFORMATION:**

**1a. TABLE OF AWARDED SPECIAL ITEM NUMBERS (SINs)**

<b>SIN</b>	<b>DESCRIPTION</b>
336320	Vehicle Signal and Restraint Systems
334220	Surveillance Systems, Wearable Body Cameras, Vehicular Video

**1b. LOWEST PRICED MODEL NUMBER AND PRICE FOR EACH SIN:**

<b><u>SIN</u></b>	<b><u>MODEL</u></b>	<b><u>PRICE</u></b>
336320	416301	\$4.11
334220	75-0302-3112-2	\$362.72

- 1c. **HOURLY RATES:**  
N/A
2. **MAXIMUM ORDER\*:** \$200,000.00
3. **MINIMUM ORDER:** \$100.00
4. **GEOGRAPHIC COVERAGE:** 48 contiguous states, Alaska, Hawaii, Washington D.C., Puerto Rico, U.S. Territories, and to a port or consolidation point within the aforementioned locations for orders that are received from overseas activities.
5. **POINT(S) OF PRODUCTION:** USA
6. **DISCOUNT FROM LIST PRICES:** 5%- 49% basic discount - for calculation of the GSA Schedule price (price paid by customers ordering from the GSA Schedule, and the price to be loaded in to GSA Advantage), the contractor should deduct the appropriate basic discount from the list price and add the prevailing IFF rate to the negotiated discounted price (Net GSA price). The current IFF is .75% and should be calculated as follows: Negotiated price divided by (1 minus .0075) which equates to Negotiated price divided by 0.9925. Example: (\$100,000 / 0.9925) = \$100,755.67
7. **QUANTITY DISCOUNT(S):** Additional 1% on orders over \$100,000.00
8. **PROMPT PAYMENT TERMS:** Net 30 Days
- 9.a **Government Purchase Cards must be accepted at or below the micro-purchase threshold.**
- 9.b **Government Purchase Cards are accepted above the micro-purchase threshold.**
10. **FOREIGN ITEMS:** N/A
- 11a. **TIME OF DELIVERY:** 45 DARO
- 11b. **EXPEDITED DELIVERY:** 30 DARO
- 11c. **OVERNIGHT AND 2-DAY DELIVERY:** Consult contractor

- 11d. **URGENT REQUIREMENTS:** Agencies can contact the Contractor's representative to effect a faster delivery. Customers are encouraged to contact the contractor for the purpose of requesting accelerated delivery.
12. **FOB POINT:** Origin
- 13a. **ORDERING ADDRESS:** 47 N Dell Ave, Ste 5, Kenvil, NJ 07847
- 13b. **ORDERING PROCEDURES:** For supplies and services, the ordering procedures, information on Blanket Purchase Agreements (BPA's) are found in Federal Acquisition Regulation (FAR) 8.405-3
14. **PAYMENT ADDRESS:** 47 N Dell Ave, Ste 5, Kenvil, NJ 07847
15. **WARRANTY PROVISION:** SCW
16. **EXPORT PACKING CHARGES:** N/A
17. **TERMS AND CONDITIONS OF GOVERNMENT PURCHASE CARD ACCEPTANCE:** None
18. **TERMS AND CONDITIONS OF RENTAL, MAINTENANCE, AND REPAIR (IF APPLICABLE):** N/A
19. **TERMS AND CONDITIONS OF INSTALLATION (IF APPLICABLE):** N/A
20. **TERMS AND CONDITIONS OF REPAIR PARTS INDICATING DATE OF PARTS PRICE LISTS AND ANY DISCOUNTS FROM LIST PRICES (IF AVAILABLE):** N/A
- 20a. **TERMS AND CONDITIONS FOR ANY OTHER SERVICES (IF APPLICABLE):** N/A
21. **LIST OF SERVICE AND DISTRIBUTION POINTS (IF APPLICABLE):** N/A
22. **LIST OF PARTICIPATING DEALERS (IF APPLICABLE):** N/A

23. PREVENTIVE MAINTENANCE (IF APPLICABLE): N/A
- 24a. SPECIAL ATTRIBUTES SUCH AS ENVIRONMENTAL ATTRIBUTES (e.g. recycled content, energy efficiency, and/or reduced pollutants): N/A
- 24b. Section 508 Compliance for EIT: N/A
25. DUNS NUMBER: 608370839
26. NOTIFICATION REGARDING REGISTRATION IN CENTRAL CONTRACTOR REGISTRATION (CCR) DATABASE: CCR Registered

Contract GS-07F-0115Y - Price List: Estes, Federal Signal, Jotto, TruckVault, Neology - 5/28/2021					
SIN	MFR	MFR Part #	PRODUCT NAME	List Price	GSA Price with IFF
336320	Estes AWS	P48-000	Pickup Truck Locker	\$1,440.58	\$1,284.63
336320	Estes AWS	SL38-000	Sedan Locker	\$1,140.58	\$982.37
336320	Estes AWS	SUV38-000	SUV Locker	\$1,290.58	\$1,133.50
336320	Federal Signal	65007	650 Series Siren, 100W microphone push-button controlled, full featured.	\$560.00	\$287.76
336320	Federal Signal	90025	Replm't spike section. 2000	\$73.00	\$66.20
336320	Federal Signal	90026	Replm't spike kit, series 2000, 10 spikes, tip guards, & sleeves	\$26.00	\$23.58
336320	Federal Signal	90027	Replm't spike kit, Rat Trap, 4 spikes	\$27.00	\$24.48
336320	Federal Signal	90031	Case, 2010 Metro and 2015 Trooper	\$114.00	\$103.38
336320	Federal Signal	90035	Stinger Training Unit, 15.5' with case **	\$253.00	\$229.42
336320	Federal Signal	90041	Case, 2025 Defender	\$148.00	\$134.21
336320	Federal Signal	90200	Spike System, 2015 Trooper, 15.5 *	\$519.00	\$470.63
336320	Federal Signal	90209	Stinger Training Unit, 15.5' without case **	\$203.00	\$184.08
336320	Federal Signal	90210	Spike System, 2010 Metro, 10 *	\$411.00	\$372.70
336320	Federal Signal	90216	Stinger Training Unit, 25' without case **	\$259.00	\$234.86
336320	Federal Signal	90225	Spike System, 2025 Defender, 25 *	\$831.00	\$753.55
336320	Federal Signal	90400	Rope and Handle	\$25.00	\$22.67
336320	Federal Signal	90502	Rat Trap II, pocket size, pursuit prevention device, 1/4" dia. spikes	\$42.00	\$38.09
336320	Federal Signal	90600	Upgrade kit, 2010 to 2015	\$208.00	\$188.61
336320	Federal Signal	93026	Replm't spike kit, series XL, 10 spikes, tip guards, & sleeves	\$27.00	\$24.48
336320	Federal Signal	93200	Spike System, 3015 XL, 15.5' with 2.1" Spikes *	\$572.00	\$518.69
336320	Federal Signal	210298	SWITCH,MULTI DIRECTIONAL	\$55.00	\$28.26
336320	Federal Signal	210539	KIT,L-BRKT,FIREBOLT	\$33.00	\$16.96
336320	Federal Signal	210782	DOME GUARD,M851,M951	\$36.00	\$18.50
336320	Federal Signal	210846	ALUMINUM FLUSH ENCLOSED BOTTOM	\$30.00	\$15.42
336320	Federal Signal	210878	DUST COVER W/BLK TOP,851	\$20.00	\$10.28
336320	Federal Signal	210890	KIT, MAGNETIC MOUNT	\$48.00	\$24.66
336320	Federal Signal	210893	1/2" PIPE MOUNT	\$36.00	\$18.50
336320	Federal Signal	210894	3/4" PIPE MOUNT	\$41.00	\$21.07
336320	Federal Signal	210982	ALUM 1" PIPE/FLUSH BOTTOM	\$52.00	\$26.72
336320	Federal Signal	211676	GUARD ASSY,CHROME,FIREBLT	\$29.00	\$14.90
336320	Federal Signal	211838	MAG MOUNT KIT	\$38.00	\$19.53
336320	Federal Signal	250520	PW SPLY,12-24V,2F,US5	\$179.00	\$91.98
336320	Federal Signal	250530	REPL PWR SPLY,US7,12-24V	\$234.00	\$120.24
336320	Federal Signal	251501	REPL FLASH TUBE,US7	\$74.00	\$38.03
336320	Federal Signal	320162	SignalMaster 31", (6) lamp, 15-ft cable	\$304.00	\$156.21
336320	Federal Signal	320172	SignalMaster 42", (8) lamp, 15-ft cable	\$412.00	\$211.71
336320	Federal Signal	320182	SignalMaster 42", (8) lamp, 30-ft cable	\$419.00	\$215.30
336320	Federal Signal	320310	SignalMaster Kit, bracket, flush mount system	\$42.00	\$21.58
336320	Federal Signal	320320	SignalMaster Kit, bracket, double "L" mount	\$49.00	\$25.18
336320	Federal Signal	320330	SignalMaster Kit, bracket, system mount	\$59.00	\$30.32
336320	Federal Signal	320340	SignalMaster Kit, bracket, universal vehicle mount	\$122.00	\$62.69
336320	Federal Signal	320350	SignalMaster Kit, bracket, foot adaptor	\$36.00	\$18.50
336320	Federal Signal	320612	6 LAMP DIRECTIONAL LT,30'	\$369.00	\$189.61
336320	Federal Signal	320762	SIGNALMASTER,LED,6LAMP,30	\$862.00	\$442.94

336320	Federal Signal	320772	SignalMaster, LED 8 lamp, 14"	\$902.00	\$463.50
336320	Federal Signal	320782	SIGNALMASTER,LED,8LAMP,30	\$945.00	\$485.59
336320	Federal Signal	320786	SIGNALMSTR,LED,8LP,60"CAB	\$977.00	\$502.04
336320	Federal Signal	320792	51",SMLED,8LAMP,30FT CBL	\$998.00	\$512.83
336320	Federal Signal	320842	VPX SignalMaster 20", (4) lamp, 30-ft cable, A-A-A-A	\$934.00	\$479.94
336320	Federal Signal	320852	VPX SignalMaster 31", (6) lamp, 15-ft cable, A-A-A-A-A-A	\$1,301.00	\$668.52
336320	Federal Signal	320862	VPX SignalMaster 31", (6) lamp, 30-ft cable, A-A-A-A-A-A	\$1,321.00	\$678.80
336320	Federal Signal	320866	VPX SignalMaster 31", (6) lamp, 60-ft cable, A-A-A-A-A-A	\$1,519.00	\$780.54
336320	Federal Signal	320872	VPX SignalMaster 42", (8) lamp, 15-ft cable, A-A-A-A-A-A-A-A	\$1,648.00	\$846.83
336320	Federal Signal	320882	VPX SignalMaster 42", (8) lamp, 30-ft cable, A-A-A-A-A-A-A-A	\$1,663.00	\$854.54
336320	Federal Signal	320886	VPX SignalMaster 42", (8) lamp, 60-ft cable, A-A-A-A-A-A-A-A	\$1,838.00	\$944.46
336320	Federal Signal	320892	VPX SignalMaster 51", (8) lamp, 30-ft cable, A-A-A-A-A-A-A-A	\$1,674.00	\$860.19
336320	Federal Signal	320893	VPX SignalMaster 51", (8) lamp, 50-ft cable, A-A-A-A-A-A-A-A	\$1,838.00	\$944.46
336320	Federal Signal	320900	Viper, 4 head, 20"	\$1,075.00	\$552.39
336320	Federal Signal	320910	VIPER 6HD SM,31",T13,30'	\$1,639.00	\$842.21
336320	Federal Signal	320935	VIPER 8HD SM,51",T13,30'	\$1,742.00	\$895.13
336320	Federal Signal	321102	ECONOMY DIR LT SYS,42"	\$525.00	\$269.77
336320	Federal Signal	321112	ECONOMY DIR LT SYS,51"	\$575.00	\$295.47
336320	Federal Signal	321712	LED ECONOMY DIR LT SYS,51	\$855.00	\$439.35
336320	Federal Signal	321722	SMLED8, 84", 3 DOT	\$1,140.00	\$585.79
336320	Federal Signal	322112	320182/331105 DIR LT SYS	\$750.00	\$385.39
336320	Federal Signal	322502	REPL BULB,DIR LT,12V	\$30.00	\$15.42
336320	Federal Signal	322612	DIR LT,51",331105 &	\$795.00	\$408.51
336320	Federal Signal	323552	TRACTOR LAMP,PAR46,5.7"	\$190.00	\$97.63
336320	Federal Signal	325039	TRACTOR LAMP,PAR36,4.5"	\$22.00	\$11.30
336320	Federal Signal	325048	TRACTOR LAMP 4.5" MAG/M	\$133.00	\$68.34
336320	Federal Signal	330104	SignalMaster controller Six or eight-lamp, 12 or 24V	\$253.50	\$130.26
336320	Federal Signal	330302	320612/331105 DIR LT SYS	\$675.00	\$346.85
336320	Federal Signal	330312	SMLED SYS,320782/331105	\$1,325.00	\$680.86
336320	Federal Signal	360800	WIRE GUARD,PAR36,TRACTOR	\$36.00	\$18.50
336320	Federal Signal	360900	WIRE GUARD,PAR46,TRACTOR	\$44.00	\$22.61
336320	Federal Signal	411177	CENTER DOME,TURBO-A	\$43.00	\$22.10
336320	Federal Signal	411178	CENTER DOME,TURBO-C	\$43.00	\$22.10
336320	Federal Signal	411179	CENTER DOME,TURBO-R	\$43.00	\$22.10
336320	Federal Signal	411189	LEFT END DOME,TURBO-R	\$47.00	\$24.15
336320	Federal Signal	413202	Kit, adapter cables, strobe power supply, (2) 12" cables	\$30.00	\$15.42
336320	Federal Signal	413216	Corner LED Cable 16-ft length	\$40.00	\$20.55
336320	Federal Signal	413230	Corner LED Cable 30-ft length	\$56.00	\$28.78
336320	Federal Signal	413330	30-ft cable length	\$87.00	\$44.71
336320	Federal Signal	413416	16-ft cable length	\$41.00	\$21.07
336320	Federal Signal	415205	SS2W, two-channel, Weatherpack connectors	\$196.00	\$100.72
336320	Federal Signal	415207	SS2A, two-channel, Amp connectors	\$163.00	\$83.76
336320	Federal Signal	415712	TURBOFL,15",(2)901,RAISED	\$715.00	\$367.41
336320	Federal Signal	416104	460L, four-head, 60W, synchronized LED Flasher	\$283.00	\$145.42
336320	Federal Signal	416106	660L, six-head, 60W, synchronized LED Flasher	\$344.00	\$176.77
336320	Federal Signal	416108	SS4A, four-head, 50W, multiple patterns, Weatherpack connectors	\$248.00	\$127.44
336320	Federal Signal	416109	SS4A, four-head, 50W, multiple patterns, Amp connectors	\$209.00	\$107.40
336320	Federal Signal	416111	(1) 460L, (4) Clear corner tubes, (2) 16-ft cables, (2) 30-ft cables	\$593.00	\$304.72
336320	Federal Signal	416118	(1) 660L, (4) Clear corner tubes, (4) 16-ft cables	\$571.00	\$293.41
336320	Federal Signal	416120	(1) 660L, (4) Clear corner tubes, (2) 16-ft cables, (2) 30-ft cables	\$592.00	\$304.20
336320	Federal Signal	416126	(1) SS4W, (4) Clear corner tubes, (2) 16-ft cables, (2) 30-ft cables	\$466.00	\$239.46
336320	Federal Signal	416127	(1) SS4A, (4) Clear corner tubes, (2) 16-ft cables, (2) 30-ft cables	\$411.00	\$211.19
336320	Federal Signal	416128	(1) SS4W, (4) Clear corner tubes, (4) 16-ft cables	\$425.00	\$218.39
336320	Federal Signal	416139	(1) SS2A, (2) Clear corner tubes, (2) 16-ft cables	\$269.00	\$138.23
336320	Federal Signal	416815	In-Line Flasher	\$94.00	\$48.30
336320	Federal Signal	442512	ROT ASSY,12V,95F,100	\$151.00	\$77.59
336320	Federal Signal	442522	ROT ASSY,12V,175F,100F	\$151.00	\$77.59
336320	Federal Signal	447302	VIBRATION MOUNT KIT	\$26.00	\$13.36
336320	Federal Signal	447303	BRANCH GUARD	\$52.00	\$26.72
336320	Federal Signal	448310	VIBRATION MOUNT KIT,SY	\$37.00	\$19.01
336320	Federal Signal	448330	BRANCH GUARD,SY/US	\$49.00	\$25.18
336320	Federal Signal	448522	REPL ROT,12V,175F,SY/HL	\$56.00	\$28.78
336320	Federal Signal	448524	REPL ROT,24V,175F,SY/HL	\$47.00	\$24.15
336320	Federal Signal	452340	HighLighter LED mounting kits - mag mount includes cig. plug	\$60.00	\$30.83



336320	Federal Signal	452341	HighLighter Mounting kit, suction cup magnet mount, cig. Plug.	\$88.00	\$45.22
336320	Federal Signal	452342	HighLighter LED mounting kits - mag mount, cig plug not included	\$33.00	\$16.96
336320	Federal Signal	454217	HighLighter Riser mount kit	\$68.00	\$34.94
336320	Federal Signal	454218	HighLighter Flat mount kit	\$41.00	\$21.07
336320	Federal Signal	454219	HighLighter LED mounting kits - roof mount bar	\$42.00	\$21.58
336320	Federal Signal	462400	MAGNETIC MTG KIT,RENEGADE	\$30.00	\$15.42
336320	Federal Signal	601310	FLUSH MOUNT,601101	\$37.00	\$19.01
336320	Federal Signal	601320	FLUSH MOUNT,601121	\$37.00	\$19.01
336320	Federal Signal	605010	Flasher, DOT, 30 amp	\$550.00	\$282.62
336320	Federal Signal	605012	Two Channel relay module, (2) 7.5 A outputs	\$162.00	\$83.24
336320	Federal Signal	620102	VisiBeam II 55W, 12VDC, adjustable spot light surface mount	\$426.00	\$218.90
336320	Federal Signal	620104	VBEAMII,RCSPOT,24V,65W,PM	\$426.00	\$218.90
336320	Federal Signal	620122	VisiBeam II 100W, 12VDC, adjustable spot light, surface mount	\$432.00	\$221.98
336320	Federal Signal	620142	VisiBeam II 100W, 12VDC, adjustable spot light, magnetic mount with cord and cigarette plug	\$510.00	\$262.07
336320	Federal Signal	620200	Wireless VisiBeam 100W, 12VDC, permanent mount	\$515.00	\$264.63
336320	Federal Signal	620201	Wireless VisiBeam 100W, 12VDC, magnetic mount, cigarette lighter plug	\$531.00	\$272.86
336320	Federal Signal	620202	V'BEAM,W'LESS,24V,65W,PM	\$505.00	\$259.50
336320	Federal Signal	640000	PA640 100W Siren	\$770.00	\$395.67
336320	Federal Signal	650001	Siren, 650 Series	\$577.00	\$296.49
336320	Federal Signal	650002	650 Siren	\$576.00	\$295.98
336320	Federal Signal	650003	Siren, 650 Series	\$587.00	\$301.63
336320	Federal Signal	650007	Speaker, AS-422/65, 100W, 12VDC	\$577.00	\$296.49
336320	Federal Signal	650201	Intelli-Flash, 2 head, 8 programmable	\$155.00	\$79.65
336320	Federal Signal	650202	Intelli-Flash, 4 head, 8 programmable	\$155.00	\$79.65
336320	Federal Signal	650301	Flasher - To be used with GL5 Kit	\$331.00	\$170.09
336320	Federal Signal	650302	Intelli-Flash Fire/EMS application, K-spec compliant, zoning capable, 16 outputs, 40A total capacity, high-side switching	\$377.00	\$193.72
336320	Federal Signal	690000	100W, PA300-012MSC, hi-lo tone, hard-wired microphone	\$518.00	\$266.18
336320	Federal Signal	690001	PA300, 100W, 12V, less microphone	\$518.00	\$266.18
336320	Federal Signal	690002	PA300 100W, PA300-012MSCPTY, priority tone, hard wired microphone	\$518.00	\$266.18
336320	Federal Signal	690004	PA300, 100W, 12V, Priority	\$518.00	\$266.18
336320	Federal Signal	690009	200W, PA300-024MSC, hi-lo tone, hard-wired microphone, 24V	\$539.00	\$276.97
336320	Federal Signal	690010	200W, PA300-012MSC, hi-lo tone, hard-wired microphone	\$524.00	\$269.26
336320	Federal Signal	690100	PA 300, AS124, 15' speaker wire	\$750.00	\$385.39
336320	Federal Signal	750501	AS124 100W Speaker	\$229.00	\$117.67
336320	Federal Signal	2025545	FSX Visor light, (12) blue LEDs with "POLICE" sign, cigarette plug, 12V-24V	\$244.00	\$125.38
336320	Federal Signal	100SC-A	Spire 100 Series Beacon, 1 inch pipe mount, short dome, Amber dome	\$120.00	\$61.66
336320	Federal Signal	100SC-B	Spire 100 Series Beacon, 1 inch pipe mount, short dome, Blue dome	\$120.00	\$61.66
336320	Federal Signal	100SC-G	Spire 100 Series Beacon, 1 inch pipe mount, short dome, Green dome	\$120.00	\$61.66
336320	Federal Signal	100SC-R	Spire 100 Series Beacon, 1 inch pipe mount, short dome, Red dome	\$120.00	\$61.66
336320	Federal Signal	100SC-W	Spire 100 Series Beacon, 1 inch pipe mount, short dome, Clear dome	\$120.00	\$61.66
336320	Federal Signal	100SD-A	Spire 100 Series Beacon, Die-cast permanent 1 inch pipe mount, short dome, Amber dome	\$140.00	\$71.94
336320	Federal Signal	100SD-B	Spire 100 Series Beacon, Die-cast permanent 1 inch pipe mount, short dome, Blue dome	\$140.00	\$71.94
336320	Federal Signal	100SD-G	Spire 100 Series Beacon, Die-cast permanent 1 inch pipe mount, short dome, Green dome	\$140.00	\$71.94
336320	Federal Signal	100SD-R	Spire 100 Series Beacon, Die-cast permanent 1 inch pipe mount, short dome, Red dome	\$140.00	\$71.94
336320	Federal Signal	100SD-W	Spire 100 Series Beacon, Die-cast permanent 1 inch pipe mount, short dome, Clear dome	\$140.00	\$71.94
336320	Federal Signal	100SM-A	Spire 100 Series Beacon, magnet mount, cigarette plug, short dome, Amber dome	\$140.00	\$71.94
336320	Federal Signal	100SM-B	Spire 100 Series Beacon, magnet mount, cigarette plug, short dome, Blue dome	\$140.00	\$71.94
336320	Federal Signal	100SM-G	Spire 100 Series Beacon, magnet mount, cigarette plug, short dome, Green dome	\$140.00	\$71.94
336320	Federal Signal	100SM-R	Spire 100 Series Beacon, magnet mount, cigarette plug, short dome, Red dome	\$140.00	\$71.94
336320	Federal Signal	100SM-W	Spire 100 Series Beacon, magnet mount, cigarette plug, short dome, Clear dome	\$140.00	\$71.94

336320	Federal Signal	100SP-A	Spire 100 Series Beacon, Polycarbonate permanent 1 inch pipe mount, short dome, Amber dome	\$130.00	\$66.80
336320	Federal Signal	100SP-B	Spire 100 Series Beacon, Polycarbonate permanent 1 inch pipe mount, short dome, Blue dome	\$130.00	\$66.80
336320	Federal Signal	100SP-G	Spire 100 Series Beacon, Polycarbonate permanent 1 inch pipe mount, short dome, Green dome	\$130.00	\$66.80
336320	Federal Signal	100SP-R	Spire 100 Series Beacon, Polycarbonate permanent 1 inch pipe mount, short dome, Red dome	\$130.00	\$66.80
336320	Federal Signal	100SP-W	Spire 100 Series Beacon, Polycarbonate permanent 1 inch pipe mount, short dome, Clear dome	\$130.00	\$66.80
336320	Federal Signal	100SS-A	Spire 100 Series Beacon, Suction-cup magnet mount, cigarette plug, short dome, Amber dome	\$150.00	\$77.08
336320	Federal Signal	100SS-B	Spire 100 Series Beacon, Suction-cup magnet mount, cigarette plug, short dome, Blue dome	\$150.00	\$77.08
336320	Federal Signal	100SS-G	Spire 100 Series Beacon, Suction-cup magnet mount, cigarette plug, short dome, Green dome	\$150.00	\$77.08
336320	Federal Signal	100SS-R	Spire 100 Series Beacon, Suction-cup magnet mount, cigarette plug, short dome, Red dome	\$150.00	\$77.08
336320	Federal Signal	100SS-W	Spire 100 Series Beacon, Suction-cup magnet mount, cigarette plug, short dome, Clear dome	\$150.00	\$77.08
336320	Federal Signal	100TC-A	Spire 100 Series Beacon, 1 inch pipe mount, tall dome, Amber dome	\$120.00	\$61.66
336320	Federal Signal	100TC-B	Spire 100 Series Beacon, 1 inch pipe mount, tall dome, Blue dome	\$120.00	\$61.66
336320	Federal Signal	100TC-G	Spire 100 Series Beacon, 1 inch pipe mount, tall dome, Green dome	\$120.00	\$61.66
336320	Federal Signal	100TC-R	Spire 100 Series Beacon, 1 inch pipe mount, tall dome, Red dome	\$120.00	\$61.66
336320	Federal Signal	100TC-W	Spire 100 Series Beacon, 1 inch pipe mount, tall dome, Clear dome	\$120.00	\$61.66
336320	Federal Signal	100TD-A	Spire 100 Series Beacon, Die-cast permanent 1 inch pipe mount, tall dome, Amber dome	\$140.00	\$71.94
336320	Federal Signal	100TD-B	Spire 100 Series Beacon, Die-cast permanent 1 inch pipe mount, tall dome, Blue dome	\$140.00	\$71.94
336320	Federal Signal	100TD-G	Spire 100 Series Beacon, Die-cast permanent 1 inch pipe mount, tall dome, Green dome	\$140.00	\$71.94
336320	Federal Signal	100TD-R	Spire 100 Series Beacon, Die-cast permanent 1 inch pipe mount, tall dome, Red dome	\$140.00	\$71.94
336320	Federal Signal	100TD-W	Spire 100 Series Beacon, Die-cast permanent 1 inch pipe mount, tall dome, Clear dome	\$140.00	\$71.94
336320	Federal Signal	100TM-A	Spire 100 Series Beacon, magnet mount, cigarette plug, tall dome, Amber dome	\$140.00	\$71.94
336320	Federal Signal	100TM-B	Spire 100 Series Beacon, magnet mount, cigarette plug, tall dome, Blue dome	\$140.00	\$71.94
336320	Federal Signal	100TM-G	Spire 100 Series Beacon, magnet mount, cigarette plug, tall dome, Green dome	\$140.00	\$71.94
336320	Federal Signal	100TM-R	Spire 100 Series Beacon, magnet mount, cigarette plug, tall dome, Red dome	\$140.00	\$71.94
336320	Federal Signal	100TM-W	Spire 100 Series Beacon, magnet mount, cigarette plug, tall dome, Clear dome	\$140.00	\$71.94
336320	Federal Signal	100TP-A	Spire 100 Series Beacon, Polycarbonate permanent 1 inch pipe mount, tall dome, Amber dome	\$130.00	\$66.80
336320	Federal Signal	100TP-B	Spire 100 Series Beacon, Polycarbonate permanent 1 inch pipe mount, tall dome, Blue dome	\$130.00	\$66.80
336320	Federal Signal	100TP-G	Spire 100 Series Beacon, Polycarbonate permanent 1 inch pipe mount, tall dome, Green dome	\$130.00	\$66.80
336320	Federal Signal	100TP-R	Spire 100 Series Beacon, Polycarbonate permanent 1 inch pipe mount, tall dome, Red dome	\$130.00	\$66.80
336320	Federal Signal	100TP-W	Spire 100 Series Beacon, Polycarbonate permanent 1 inch pipe mount, tall dome, Clear dome	\$130.00	\$66.80
336320	Federal Signal	100TS-A	Spire 100 Series Beacon, Suction-cup magnet mount, cigarette plug, tall dome, Amber dome	\$150.00	\$77.08
336320	Federal Signal	100TS-B	Spire 100 Series Beacon, Suction-cup magnet mount, cigarette plug, tall dome, Blue dome	\$150.00	\$77.08
336320	Federal Signal	100TS-G	Spire 100 Series Beacon, Suction-cup magnet mount, cigarette plug, tall dome, Green dome	\$150.00	\$77.08
336320	Federal Signal	100TS-R	Spire 100 Series Beacon, Suction-cup magnet mount, cigarette plug, tall dome, Red dome	\$150.00	\$77.08
336320	Federal Signal	100TS-W	Spire 100 Series Beacon, Suction-cup magnet mount, cigarette plug, tall dome, Clear dome	\$150.00	\$77.08
336320	Federal Signal	200069-95	BOTTOM PLATE,451/551	\$21.00	\$10.79
336320	Federal Signal	2005082B-12-95	REPL PC BOARD,10J,2F,551+	\$168.00	\$86.33
336320	Federal Signal	2005082B-23-95	REPL PC BOARD,8J,2F,451+	\$145.00	\$74.51

336320	Federal Signal	200557-95	ROUND MAGNET,RB-80,1 7/64	\$22.00	\$11.30
336320	Federal Signal	200589-95	REPL CIG LIGHTER PLUG,15A	\$31.00	\$15.93
336320	Federal Signal	200766-95	REPL DOME,651/901-B	\$37.00	\$19.01
336320	Federal Signal	200767-95	REPL DOME,651/901-A	\$37.00	\$19.01
336320	Federal Signal	200768-95	REPL DOME,651/901-C	\$37.00	\$19.01
336320	Federal Signal	200769-95	REPL DOME,651/901-R	\$37.00	\$19.01
336320	Federal Signal	200770-95	REPL DOME,651/901-G	\$44.00	\$22.61
336320	Federal Signal	200771-95	REPL DOME,851/951-B	\$37.00	\$19.01
336320	Federal Signal	200772-95	REPL DOME,851/951-C	\$37.00	\$19.01
336320	Federal Signal	200773-95	REPL DOME,851/951-R	\$39.00	\$20.04
336320	Federal Signal	200775-95	REPL DOME,851/951-A	\$37.00	\$19.01
336320	Federal Signal	200B-Short	Branch guard, AM Beacon, short	\$50.00	\$25.69
336320	Federal Signal	200B-Tall	Branch guard, AM Beacon, tall	\$50.00	\$25.69
336320	Federal Signal	200SC-A	Spire 200 Series Beacon, Single color, FS Link, 1 inch pipe mount, short dome, Amber dome, Amber LEDs	\$200.00	\$102.77
336320	Federal Signal	200SC-B	Spire 200 Series Beacon, Single color, FS Link, 1 inch pipe mount, short dome, Blue dome, Blue LEDs	\$200.00	\$102.77
336320	Federal Signal	200SC-G	Spire 200 Series Beacon, Single color, FS Link, 1 inch pipe mount, short dome, Green dome, Green LEDs	\$200.00	\$102.77
336320	Federal Signal	200SC-R	Spire 200 Series Beacon, Single color, FS Link, 1 inch pipe mount, short dome, Red dome, Red LEDs	\$200.00	\$102.77
336320	Federal Signal	200SC-W	Spire 200 Series Beacon, Single color, FS Link, 1 inch pipe mount, short dome, Clear dome, White LEDs	\$200.00	\$102.77
336320	Federal Signal	200SD-A	Spire 200 Series Beacon, Single color, FS Link, Die-cast permanent/1 inch pipe mount, short dome, Amber dome, Amber LEDs	\$220.00	\$113.05
336320	Federal Signal	200SD-B	Spire 200 Series Beacon, Single color, FS Link, Die-cast permanent / 1 inch pipe mount, short dome, Blue dome, Blue LEDs	\$220.00	\$113.05
336320	Federal Signal	200SD-G	Spire 200 Series Beacon, Single color, FS Link, Die-cast permanent / 1 inch pipe mount, short dome, Green dome, Green LEDs	\$220.00	\$113.05
336320	Federal Signal	200SD-R	Spire 200 Series Beacon, Single color, FS Link, Die-cast permanent / 1 inch pipe mount, short dome, Red dome, Red LEDs	\$220.00	\$113.05
336320	Federal Signal	200SD-W	Spire 200 Series Beacon, Single color, FS Link, Die-cast permanent / 1 inch pipe mount, short dome, Clear dome, White LEDs	\$220.00	\$113.05
336320	Federal Signal	200SM-A	Spire 200 Series Beacon, Single color, FS Link, Magnetic mount, cigarette plug, short dome, Amber dome, Amber LEDs	\$220.00	\$113.05
336320	Federal Signal	200SM-B	Spire 200 Series Beacon, Single color, FS Link, Magnetic mount, cigarette plug, short dome, Blue dome, Blue LEDs	\$220.00	\$113.05
336320	Federal Signal	200SM-G	Spire 200 Series Beacon, Single color, FS Link, Magnetic mount, cigarette plug, short dome, Green dome, Green LEDs	\$220.00	\$113.05
336320	Federal Signal	200SM-R	Spire 200 Series Beacon, Single color, FS Link, Magnetic mount, cigarette plug, short dome, Red dome, Red LEDs	\$220.00	\$113.05
336320	Federal Signal	200SM-W	Spire 200 Series Beacon, Single color, FS Link, Magnetic mount, cigarette plug, short dome, Clear dome, White LEDs	\$220.00	\$113.05
336320	Federal Signal	200SP-A	Spire 200 Series Beacon, Single color, FS Link, Polycarbonate permanent/1 inch pipe mount, short dome, Amber dome, Amber LEDs	\$210.00	\$107.91
336320	Federal Signal	200SP-B	Spire 200 Series Beacon, Single color, FS Link, Polycarbonate permanent / 1 inch pipe mount, short dome, Blue dome, Blue LEDs	\$210.00	\$107.91
336320	Federal Signal	200SP-G	Spire 200 Series Beacon, Single color, FS Link, Polycarbonate permanent / 1 inch pipe mount, short dome, Green dome, Green LEDs	\$210.00	\$107.91
336320	Federal Signal	200SP-R	Spire 200 Series Beacon, Single color, FS Link, Polycarbonate permanent / 1 inch pipe mount, short dome, Red dome, Red LEDs	\$210.00	\$107.91
336320	Federal Signal	200SP-W	Spire 200 Series Beacon, Single color, FS Link, Polycarbonate permanent / 1 inch pipe mount, short dome, Clear dome, White LEDs	\$210.00	\$107.91
336320	Federal Signal	200SS-A	Spire 200 Series Beacon, Single color, FS Link, Suction Cup Magnetic mount, cigarette plug, short dome, Amber dome, Amber LEDs	\$230.00	\$118.19
336320	Federal Signal	200SS-B	Spire 200 Series Beacon, Single color, FS Link, Suction Cup Magnetic mount, cigarette plug, short dome, Blue dome, Blue LEDs	\$230.00	\$118.19
336320	Federal Signal	200SS-G	Spire 200 Series Beacon, Single color, FS Link, Suction Cup Magnetic mount, cigarette plug, short dome, Green dome, Green LEDs	\$230.00	\$118.19

336320	Federal Signal	200SS-R	Spire 200 Series Beacon, Single color, FS Link, Suction Cup Magnetic mount, cigarette plug, short dome, Red dome, Red LEDs	\$230.00	\$118.19
336320	Federal Signal	200SS-W	Spire 200 Series Beacon, Single color, FS Link, Suction Cup Magnetic mount, cigarette plug, short dome, Clear dome, White LEDs	\$230.00	\$118.19
336320	Federal Signal	200TC-A	Spire 200 Series Beacon, Single color, FS Link, 1 inch pipe mount, Tall dome, Amber dome, Amber LEDs	\$200.00	\$102.77
336320	Federal Signal	200TC-B	Spire 200 Series Beacon, Single color, FS Link, 1 inch pipe mount, Tall dome, Blue dome, Blue LEDs	\$200.00	\$102.77
336320	Federal Signal	200TC-G	Spire 200 Series Beacon, Single color, FS Link, 1 inch pipe mount, Tall dome, Green dome, Green LEDs	\$200.00	\$102.77
336320	Federal Signal	200TC-R	Spire 200 Series Beacon, Single color, FS Link, 1 inch pipe mount, Tall dome, Red dome, Red LEDs	\$200.00	\$102.77
336320	Federal Signal	200TC-W	Spire 200 Series Beacon, Single color, FS Link, 1 inch pipe mount, Tall dome, Clear dome, White LEDs	\$200.00	\$102.77
336320	Federal Signal	200TD-A	Spire 200 Series Beacon, Single color, FS Link, Die-cast permanent/1 inch pipe mount, Tall dome, Amber dome, Amber LEDs	\$220.00	\$113.05
336320	Federal Signal	200TD-B	Spire 200 Series Beacon, Single color, FS Link, Die-cast permanent / 1 inch pipe mount, Tall dome, Blue dome, Blue LEDs	\$220.00	\$113.05
336320	Federal Signal	200TD-G	Spire 200 Series Beacon, Single color, FS Link, Die-cast permanent / 1 inch pipe mount, Tall dome, Green dome, Green LEDs	\$220.00	\$113.05
336320	Federal Signal	200TD-R	Spire 200 Series Beacon, Single color, FS Link, Die-cast permanent / 1 inch pipe mount, Tall dome, Red dome, Red LEDs	\$220.00	\$113.05
336320	Federal Signal	200TD-W	Spire 200 Series Beacon, Single color, FS Link, Die-cast permanent / 1 inch pipe mount, Tall dome, Clear dome, White LEDs	\$220.00	\$113.05
336320	Federal Signal	200TM-A	Spire 200 Series Beacon, Single color, FS Link, Magnetic mount, cigarette plug, Tall dome, Amber dome, Amber LEDs	\$220.00	\$113.05
336320	Federal Signal	200TM-B	Spire 200 Series Beacon, Single color, FS Link, Magnetic mount, cigarette plug, Tall dome, Blue dome, Blue LEDs	\$220.00	\$113.05
336320	Federal Signal	200TM-G	Spire 200 Series Beacon, Single color, FS Link, Magnetic mount, cigarette plug, Tall dome, Green dome, Green LEDs	\$220.00	\$113.05
336320	Federal Signal	200TM-R	Spire 200 Series Beacon, Single color, FS Link, Magnetic mount, cigarette plug, Tall dome, Red dome, Red LEDs	\$220.00	\$113.05
336320	Federal Signal	200TM-W	Spire 200 Series Beacon, Single color, FS Link, Magnetic mount, cigarette plug, Tall dome, Clear dome, White LEDs	\$220.00	\$113.05
336320	Federal Signal	200TP-A	Spire 200 Series Beacon, Single color, FS Link, Polycarbonate permanent/1 inch pipe mount, Tall dome, Amber dome, Amber LEDs	\$210.00	\$107.91
336320	Federal Signal	200TP-B	Spire 200 Series Beacon, Single color, FS Link, Polycarbonate permanent / 1 inch pipe mount, Tall dome, Blue dome, Blue LEDs	\$210.00	\$107.91
336320	Federal Signal	200TP-G	Spire 200 Series Beacon, Single color, FS Link, Polycarbonate permanent / 1 inch pipe mount, Tall dome, Green dome, Green LEDs	\$210.00	\$107.91
336320	Federal Signal	200TP-R	Spire 200 Series Beacon, Single color, FS Link, Polycarbonate permanent / 1 inch pipe mount, Tall dome, Red dome, Red LEDs	\$210.00	\$107.91
336320	Federal Signal	200TP-W	Spire 200 Series Beacon, Single color, FS Link, Polycarbonate permanent / 1 inch pipe mount, Tall dome, Clear dome, White LEDs	\$210.00	\$107.91
336320	Federal Signal	200TS-A	Spire 200 Series Beacon, Single color, FS Link, Suction Cup Magnetic mount, cigarette plug, Tall dome, Amber dome, Amber LEDs	\$230.00	\$118.19
336320	Federal Signal	200TS-B	Spire 200 Series Beacon, Single color, FS Link, Suction Cup Magnetic mount, cigarette plug, Tall dome, Blue dome, Blue LEDs	\$230.00	\$118.19
336320	Federal Signal	200TS-G	Spire 200 Series Beacon, Single color, FS Link, Suction Cup Magnetic mount, cigarette plug, Tall dome, Green dome, Green LEDs	\$230.00	\$118.19
336320	Federal Signal	200TS-R	Spire 200 Series Beacon, Single color, FS Link, Suction Cup Magnetic mount, cigarette plug, Tall dome, Red dome, Red LEDs	\$230.00	\$118.19
336320	Federal Signal	200TS-W	Spire 200 Series Beacon, Single color, FS Link, Suction Cup Magnetic mount, cigarette plug, Tall dome, Clear dome, White LEDs	\$230.00	\$118.19
336320	Federal Signal	2020277-UP	Siren, SCS 1000-D, 30W	\$270.00	\$138.74

336320	Federal Signal	2025545-01	FSX Visor light, (12) blue LEDs with "POLICIA" sign, cigarette plug, 12V-24V	\$199.00	\$102.26
336320	Federal Signal	2030001FS	FSX visor light (12) Blue LEDs with "Policia" sign, cigarette plug, 12V-24V	\$199.00	\$102.26
336320	Federal Signal	2030012FS	FSX visor light (6) Blue LEDs and (6) Red LEDs with "Police" sign, cigarette plug, 12V-24V	\$199.00	\$102.26
336320	Federal Signal	2030029FS	FSX Visor Light, (6) Blue LEDs and (6) Red LEDs with "FBI" sign, cigarette plus, 12-24 VDC	\$199.00	\$102.26
336320	Federal Signal	205520-95	REPL BASE,PULSATOR	\$31.00	\$15.93
336320	Federal Signal	208551-95	BASE,602/651/851/901/951	\$36.00	\$18.50
336320	Federal Signal	208564-95	REPL DOME,451-G	\$25.00	\$12.85
336320	Federal Signal	208566-95	REPL DOME,451-B	\$25.00	\$12.85
336320	Federal Signal	208567-95	Pulsator Dome, short, Amber	\$25.00	\$12.85
336320	Federal Signal	208568-95	REPL DOME,451-R	\$25.00	\$12.85
336320	Federal Signal	208569-95	REPL DOME,451-C	\$25.00	\$12.85
336320	Federal Signal	208664-95	REPL DOME,551-G	\$25.00	\$12.85
336320	Federal Signal	208666-95	REPL DOME,551-B	\$25.00	\$12.85
336320	Federal Signal	208667-95	Pulsator Dome, tall, Amber	\$25.00	\$12.85
336320	Federal Signal	208668-95	REPL DOME,551-R	\$25.00	\$12.85
336320	Federal Signal	208669-95	REPL DOME,551-C	\$25.00	\$12.85
336320	Federal Signal	210050SSG	KIT, ALUMINUM FLUSH MAGNETIC MOUNT	\$57.00	\$29.29
336320	Federal Signal	210299SSG	SWITCH,ONE DIRECTIONAL	\$28.00	\$14.39
336320	Federal Signal	210330SSG	EVAC+,ALARM,87DB,12-48V	\$53.00	\$27.23
336320	Federal Signal	210331SSG	EVAC+,ALARM,97DB,12-48V	\$54.00	\$27.75
336320	Federal Signal	210333SSG	EVAC+,ALARM,107DB,12-48V	\$59.00	\$30.32
336320	Federal Signal	210335SSG	EVAC+,ALARM,112DB,12-48V	\$77.00	\$39.57
336320	Federal Signal	210343SSG	EVAC W/GROMMET,107DB,	\$65.00	\$33.40
336320	Federal Signal	210361SSG	2-TONE,ALARM,97DB,12-48V	\$99.00	\$50.87
336320	Federal Signal	210363SSG	2-TONE,ALARM,107DB,12-48V	\$99.00	\$50.87
336320	Federal Signal	210365SSG	2-TONE,ALARM,112DB,12-48V	\$99.00	\$50.87
336320	Federal Signal	210830SSG	POLY 1"PIPE/FLUSH BOTTOM	\$21.00	\$10.79
336320	Federal Signal	210831SSG	POLY FLUSH MAG MNT KIT	\$53.00	\$27.23
336320	Federal Signal	210850SSG	3/4" PIPE MOUNT,FIREBOLT	\$32.00	\$16.44
336320	Federal Signal	210873-02	FIREBOLT,12-72V,MAG MT-A	\$119.00	\$61.15
336320	Federal Signal	210873-03	FIREBOLT,12-72V,MAG MT-B	\$119.00	\$61.15
336320	Federal Signal	210873-04	FireBolt 12-72V, Magnetic Mount	\$119.00	\$61.15
336320	Federal Signal	210883SSG	SELF-LEVELING BRACKET	\$168.00	\$86.33
336320	Federal Signal	210895SSG	1" PIPE MNT W/BOT,451	\$42.00	\$21.58
336320	Federal Signal	210923SSG	BOTTOM,ENCLOSED,1"	\$30.00	\$15.42
336320	Federal Signal	210924SSG	ALUM 3/4" PIPE/FLUSH BOTT	\$50.00	\$25.69
336320	Federal Signal	210939SSG	KIT,L MTG BRKT,651/851	\$41.00	\$21.07
336320	Federal Signal	210960-46	HighLighter LED 46" roof mounting bar	\$130.00	\$66.80
336320	Federal Signal	210960-54	Mounting Bars, 54 inch, Roof mount bar	\$140.00	\$71.94
336320	Federal Signal	210960-65	HighLighter LED 65" roof mounting bar	\$150.00	\$77.08
336320	Federal Signal	210961SSG	KIT, MOUNTING PLATE, BEACON	\$60.00	\$30.83
336320	Federal Signal	210962SSG	ENDCAP KIT, ROOF MOUNT BAR	\$28.00	\$14.39
336320	Federal Signal	211007-95	REPL PWR SUPPLY,115V,1F	\$193.00	\$99.17
336320	Federal Signal	211024-95	REPL PWR SUPPLY,72V,1F	\$215.00	\$110.48
336320	Federal Signal	211200-95	REPL FLASH TUBE,651/901	\$53.00	\$27.23
336320	Federal Signal	211356-95	PWRSPPLY/FLASH TUBE,115V,FB	\$71.00	\$36.48
336320	Federal Signal	211360-95	PWR SPLY/FLASH TUBE,FB	\$65.00	\$33.40
336320	Federal Signal	211400-95	REPL FLASH TUBE,851/951	\$59.00	\$30.32
336320	Federal Signal	211680-02	Pulsator 451 Plus, short dome, Amber dome, Perm mount	\$183.00	\$94.04
336320	Federal Signal	211680-03	MDL451+,STRB,12-48V,2F-B	\$183.00	\$94.04
336320	Federal Signal	211680-04	MDL451+,STRB,12-48V,2F-R	\$183.00	\$94.04
336320	Federal Signal	211680-05	MDL451+,STRB,12-48V,2F-C	\$183.00	\$94.04
336320	Federal Signal	211681-02	MDL551+,STRB,12-48V,2F-A	\$183.00	\$94.04
336320	Federal Signal	211681-04	MDL551+,STRB,12-48V,2F-R	\$183.00	\$94.04
336320	Federal Signal	211681-05	MDL551+,STRB,12-48V,2F-C	\$183.00	\$94.04
336320	Federal Signal	211682-02	Pulsator 451 Plus, short dome, Amber dome, magnet mount	\$239.00	\$122.81
336320	Federal Signal	211683-02	MDL551+,STRB,12-48V,4F-A	\$210.00	\$107.91
336320	Federal Signal	211683-05	MDL551+,STRB,12-48V,4F-C	\$210.00	\$107.91
336320	Federal Signal	211684-02	MDL551+,10J,2F,MAG MNT-A	\$210.00	\$107.91
336320	Federal Signal	211684-05	MDL551+,10J,2F,MAG MNT-C	\$243.00	\$124.87
336320	Federal Signal	211684-06	MDL551+,10J,2F,MAG MNT-G	\$243.00	\$124.87
336320	Federal Signal	211685-02	MDL551+,10J,2F,MAG MNT-A	\$187.00	\$96.09
336320	Federal Signal	211687-02	MDL851,2F,ALUM BTM W/DUST	\$238.00	\$122.30

336320	Federal Signal	211688-02	MDL951,2F,ALUM BTM W/DUST	\$291.00	\$149.53
336320	Federal Signal	211691-02	MDL551+,12-48V,8J,2F-A	\$190.00	\$97.63
336320	Federal Signal	211691-04	MDL551+,12-48V,8J,2F-R	\$190.00	\$97.63
336320	Federal Signal	211694-02	PULSATOR 551,1-F,12-24V	\$131.00	\$67.31
336320	Federal Signal	211694-03	PULSATOR 551,1-F,12-24V	\$131.00	\$67.31
336320	Federal Signal	211694-04	PULSATOR 551,1-F,12-24V	\$131.00	\$67.31
336320	Federal Signal	211694-05	PULSATOR 551,1-F,12-24V	\$131.00	\$67.31
336320	Federal Signal	211695-02	PULS551,1F,12-24V,MAG MNT	\$190.00	\$97.63
336320	Federal Signal	211740-02	MODEL901,STRB,12-48V,2F-A	\$190.00	\$97.63
336320	Federal Signal	211742-02	MODEL951,STRB,12-48V,2F-A	\$321.00	\$164.95
336320	Federal Signal	211779-02	MODEL AL2,LED,ANOD.BASE	\$304.00	\$156.21
336320	Federal Signal	211792C	LTB,CB SPEC,22",STRB	\$743.00	\$381.79
336320	Federal Signal	211792C-0042-8F	LTB,CB SPEC,22",STB,W/8'	\$753.00	\$386.93
336320	Federal Signal	211820-02	MDL551+HD,STRB,2F-A	\$195.00	\$100.20
336320	Federal Signal	211820-03	MDL551+HD,STRB,2F-B	\$195.00	\$100.20
336320	Federal Signal	211820-04	MDL551+HD,STRB,2F-R	\$195.00	\$100.20
336320	Federal Signal	211820-05	MDL551+HD,STRB,2F-C	\$195.00	\$100.20
336320	Federal Signal	211820-06	MDL551+HD,STRB,2F-G	\$195.00	\$100.20
336320	Federal Signal	211823-02	MDL451+HD,STRB,2F-A	\$195.00	\$100.20
336320	Federal Signal	211823-03	MDL451+HD,STRB,2F-B	\$195.00	\$100.20
336320	Federal Signal	211823-04	MDL451+HD,STRB,2F-R	\$195.00	\$100.20
336320	Federal Signal	211823-05	MDL451+HD,STRB,2F-C	\$195.00	\$100.20
336320	Federal Signal	211823-06	MDL451+HD,STRB,2F-G	\$195.00	\$100.20
336320	Federal Signal	211826-02	FIREBLT+,12-72V,NOCORD-A	\$162.00	\$83.24
336320	Federal Signal	211829-02	MODEL 551HD,220V,2F-A	\$218.00	\$112.02
336320	Federal Signal	211829-04	MODEL 551HD,220V,2F-R	\$218.00	\$112.02
336320	Federal Signal	211832-02	MDL551+HD,STRB,8J,2F-A	\$209.00	\$107.40
336320	Federal Signal	211832-03	MDL551+HD,STRB,8J,2F-B	\$209.00	\$107.40
336320	Federal Signal	211900-02SC	TURBOBEAM 00,15",24V-A	\$236.00	\$121.27
336320	Federal Signal	211900-43SC	TURBOBEAM 00,15",24V-R/B	\$289.00	\$148.50
336320	Federal Signal	211906-02SC	TURBOBEAM00,15",MAG MNT-A	\$325.00	\$167.00
336320	Federal Signal	211906-04SC	TURBOBEAM00,15",MAG MNT-R	\$336.00	\$172.65
336320	Federal Signal	211914-02SC	TURBOBEAM00,22",MAG MNT-A	\$315.00	\$161.86
336320	Federal Signal	211921-02	TURBOBM00,47",ISO.ROT-A	\$851.00	\$437.29
336320	Federal Signal	211925-02	MODEL 551,STRB,110V,2F-A	\$203.00	\$104.31
336320	Federal Signal	211925-03	MODEL 551,STRB,110V,2F-B	\$203.00	\$104.31
336320	Federal Signal	211925-04	MODEL 551,STRB,110V,2F-R	\$203.00	\$104.31
336320	Federal Signal	211927-02	TURBOBM00,47",ISO.ROT &	\$941.00	\$483.54
336320	Federal Signal	211934-02	MDL951,2F,MAG MNT-A	\$362.00	\$186.02
336320	Federal Signal	211935-02	MODEL951,STRB,CORD,2F-A	\$359.00	\$184.47
336320	Federal Signal	211960-02-8F	TURBOFLSH 00,22",RAISED-A	\$680.00	\$349.42
336320	Federal Signal	212356-02	FIREBOLT STRB,115V-A	\$142.00	\$72.97
336320	Federal Signal	212356-03	FIREBOLT STRB,115V-B	\$142.00	\$72.97
336320	Federal Signal	212356-04	FIREBOLT STRB,115V-R	\$142.00	\$72.97
336320	Federal Signal	212356-05	FIREBOLT STRB,115V-C	\$142.00	\$72.97
336320	Federal Signal	212356-06	FIREBOLT STRB,115V-G	\$142.00	\$72.97
336320	Federal Signal	212551-04	MODEL 551,110V,1F,-R	\$200.00	\$102.77
336320	Federal Signal	212650-02SB	PULSATOR LED, PERM./PIPE MNT	\$144.00	\$73.99
336320	Federal Signal	212650-04SB	PULSATOR LED, PERM./PIPE MNT	\$144.00	\$73.99
336320	Federal Signal	212652-02SB	PULSATOR LED, MAG. MNT	\$176.00	\$90.44
336320	Federal Signal	212652-04SB	PULSATOR LED, MAG MOUNT, TALL DOME, RED DOME,	\$176.00	\$90.44
336320	Federal Signal	212654-02SB	PULSATOR LED, SUCT. MNT	\$176.00	\$90.44
336320	Federal Signal	212654-04SB	PULSATOR LED, SUCTION-CUP MAG. MOUNT, CIGARETTE PLUG, TALL DOME, RED DOME, CLASS 2	\$169.00	\$86.84
336320	Federal Signal	212660-02SB	PULSATOR LED, PERM./PIPE MNT	\$167.00	\$85.81
336320	Federal Signal	212660-04SB	PULSATOR LED, PERM./PIPE MNT	\$167.00	\$85.81
336320	Federal Signal	212660-05SB	PULSATOR LED, PERM./PIPE MNT	\$167.00	\$85.81
336320	Federal Signal	212662-02SB	PULSATOR LED, MAG. MNT	\$201.00	\$103.28
336320	Federal Signal	212662-04SB	PULSATOR LED, MAG MOUNT, TALL DOME, RED DOME,	\$193.00	\$99.17
336320	Federal Signal	212664-02SB	PULSATOR LED, SUCT. MNT	\$206.00	\$105.85
336320	Federal Signal	212664-04SB	PULSATOR LED, SUCTION-CUP MAG. MOUNT, CIGARETTE PLUG, TALL DOME, RED DOME.	\$198.00	\$101.74
336320	Federal Signal	212670-02SB	PULSATOR 451 LED,PERM/PIPE MNT	\$144.00	\$73.99
336320	Federal Signal	212670-04SB	PULSATOR 451 LED,PERM/PIPE MNT	\$138.00	\$70.91
336320	Federal Signal	212670-05SB	PULSATOR 451 LED,PERM/PIPE MNT	\$138.00	\$70.91
336320	Federal Signal	212672-02SB	PULSATOR 451 LED, MAG. MNT	\$181.00	\$93.01

336320	Federal Signal	212672-04SB	PULSATOR 451 LED, MAG MOUNT, CIGARETTE PLUG, SHORT DOME, RED DOME.	\$181.00	\$93.01
336320	Federal Signal	212674-02SB	PULSATOR 451 LED, SUCT. MNT	\$176.00	\$90.44
336320	Federal Signal	212674-04SB	PULSATOR 451 LED, SUCTION CUP MAG MOUNT, CIGARETTE PLUG, SHORT DOME, RED DOME.	\$169.00	\$86.84
336320	Federal Signal	21960-54	HighLighter LED 54" roof mounting bar	\$125.00	\$64.23
336320	Federal Signal	220100-02	FIREBOLT,STROBE,12-72V,-A	\$95.00	\$48.82
336320	Federal Signal	220100-03	FIREBOLT,STROBE,12-72V,-B	\$95.00	\$48.82
336320	Federal Signal	220100-04	FIREBOLT,STROBE,12-72V,-R	\$95.00	\$48.82
336320	Federal Signal	220100-05	FIREBOLT,STROBE,12-72V,-C	\$95.00	\$48.82
336320	Federal Signal	220100-06	FIREBOLT,STROBE,12-72V,-G	\$95.00	\$48.82
336320	Federal Signal	220105-02	FIREBOLT,5J,12-48V,PERM-A	\$156.00	\$80.16
336320	Federal Signal	220105-05	FIREBOLT,5J,12-48V,PERM-C	\$144.00	\$73.99
336320	Federal Signal	220110-02	FIREBOLT,5J,12-48V,MAG-A	\$159.00	\$81.70
336320	Federal Signal	220200-02	FIREBOLT PLUS,12-72V,-A	\$130.00	\$66.80
336320	Federal Signal	220200-03	FIREBOLT PLUS,12-72V,-B	\$130.00	\$66.80
336320	Federal Signal	220200-04	FIREBOLT PLUS,12-72V,-R	\$130.00	\$66.80
336320	Federal Signal	220200-05	FIREBOLT PLUS,12-72V,-C	\$130.00	\$66.80
336320	Federal Signal	220200-06	FIREBOLT PLUS,12-72V,-G	\$130.00	\$66.80
336320	Federal Signal	220208-02	FIREBOLT +,12-72V,MG,-A	\$170.00	\$87.36
336320	Federal Signal	220208-03	FIREBOLT +,12-72V,MG,-B	\$170.00	\$87.36
336320	Federal Signal	220208-05	FIREBOLT +,12-72V,MG,-C	\$170.00	\$87.36
336320	Federal Signal	220208-06	FIREBOLT +,12-72V,MG,-G	\$170.00	\$87.36
336320	Federal Signal	220250-03	FIREBOLT LED, PERM./PIPE MNT.	\$96.00	\$49.33
336320	Federal Signal	220250-04	FIREBOLT LED, PERM./PIPE MNT.	\$96.00	\$49.33
336320	Federal Signal	220250-05	FIREBOLT LED, PERM./PIPE MNT.	\$96.00	\$49.33
336320	Federal Signal	220250-06	FireBolt Beacon, Green LED, Green dome, Permanent 1/2" pipe mount, Class 2	\$96.00	\$49.33
336320	Federal Signal	220260-02	FIREBOLT LED, MAG. MNT.	\$128.00	\$65.77
336320	Federal Signal	220260-03	FIREBOLT LED, MAG. MNT.	\$128.00	\$65.77
336320	Federal Signal	220260-04	FIREBOLT LED, MAG. MNT.	\$128.00	\$65.77
336320	Federal Signal	220260-05	FIREBOLT LED, MAG. MNT.	\$128.00	\$65.77
336320	Federal Signal	220260-06	FireBolt Beacon, Green LED, Green dome, magnetic mount, cigarette plug, Class 2	\$128.00	\$65.77
336320	Federal Signal	220300-02	MODEL 401,12-48V,2F,-A	\$184.00	\$94.55
336320	Federal Signal	220300-03	MODEL 401,12-48V,2F,-B	\$184.00	\$94.55
336320	Federal Signal	220300-04	MODEL 401,12-48V,2F-R	\$175.00	\$89.92
336320	Federal Signal	220301-02	MODEL 401,12-24V,1F,-A	\$184.00	\$94.55
336320	Federal Signal	220308-02	MODEL 401,12-48V,MG,-A	\$218.00	\$112.02
336320	Federal Signal	220308-03	MODEL 401,12-48V,MG,-B	\$197.00	\$101.23
336320	Federal Signal	220308-04	MODEL 401,12-48V,MG,-R	\$197.00	\$101.23
336320	Federal Signal	220309-02	MODEL 401,12-24V,1F,MG,-A	\$212.00	\$108.94
336320	Federal Signal	220309-03	MODEL 401,12-24V,1F,MG,-B	\$212.00	\$108.94
336320	Federal Signal	220350-02	Firebolt Class 3 LED Beacon, Amber dome, permanent mount	\$82.00	\$42.14
336320	Federal Signal	220360-02	Firebolt Class 3 LED Beacon, Amber dome, magnet mount / cig. Plug	\$95.00	\$48.82
336320	Federal Signal	220SC-AB	Spire 200 Series Beacon, Dual Color, FS Link, 1 inch pipe mount, short dome, Clear dome, Amber/Blue LEDs	\$215.00	\$110.48
336320	Federal Signal	220SC-AG	Spire 200 Series Beacon, Dual Color, FS Link, 1 inch pipe mount, short dome, Clear dome, Amber/Green LEDs	\$215.00	\$110.48
336320	Federal Signal	220SC-AR	Spire 200 Series Beacon, Dual Color, FS Link, 1 inch pipe mount, short dome, Clear dome, Amber/Red LEDs	\$215.00	\$110.48
336320	Federal Signal	220SC-AW	Spire 200 Series Beacon, Dual Color, FS Link, 1 inch pipe mount, short dome, Clear dome, Amber/White LEDs	\$215.00	\$110.48
336320	Federal Signal	220SD-AB	Spire 200 Series Beacon, Dual Color, FS Link, Die-cast permanent 1 inch pipe mount, short dome, Clear dome, Amber/Blue LEDs	\$235.00	\$120.76
336320	Federal Signal	220SD-AG	Spire 200 Series Beacon, Dual Color, FS Link, Die-cast permanent 1 inch pipe mount, short dome, Clear dome, Amber/Green LEDs	\$235.00	\$120.76
336320	Federal Signal	220SD-AR	Spire 200 Series Beacon, Dual Color, FS Link, Die-cast permanent 1 inch pipe mount, short dome, Clear dome, Amber/Red LEDs	\$235.00	\$120.76
336320	Federal Signal	220SD-AW	Spire 200 Series Beacon, Dual Color, FS Link, Die-cast permanent 1 inch pipe mount, short dome, Clear dome, Amber/White LEDs	\$235.00	\$120.76
336320	Federal Signal	220SM-AB	Spire 200 Series Beacon, Dual Color, FS Link, Magnetic mount, Cigarette plug, short dome, Clear dome, Amber/Blue LEDs	\$235.00	\$120.76

336320	Federal Signal	220SM-AG	Spire 200 Series Beacon, Dual Color, FS Link, Magnetic mount, Cigarette plug, short dome, Clear dome, Amber/Green LEDs	\$235.00	\$120.76
336320	Federal Signal	220SM-AR	Spire 200 Series Beacon, Dual Color, FS Link, Magnetic mount, Cigarette plug, short dome, Clear dome, Amber/Red LEDs	\$235.00	\$120.76
336320	Federal Signal	220SM-AW	Spire 200 Series Beacon, Dual Color, FS Link, Magnetic mount, Cigarette plug, short dome, Clear dome, Amber/White LEDs	\$235.00	\$120.76
336320	Federal Signal	220SP-AB	Spire 200 Series Beacon, Dual Color, FS Link, Polycarbonate permanent 1 inch pipe mount, short dome, Clear dome, Amber/Blue LEDs	\$225.00	\$115.62
336320	Federal Signal	220SP-AG	Spire 200 Series Beacon, Dual Color, FS Link, Polycarbonate permanent 1 inch pipe mount, short dome, Clear dome, Amber/Green LEDs	\$225.00	\$115.62
336320	Federal Signal	220SP-AR	Spire 200 Series Beacon, Dual Color, FS Link, Polycarbonate permanent 1 inch pipe mount, short dome, Clear dome, Amber/Red LEDs	\$225.00	\$115.62
336320	Federal Signal	220SP-AW	Spire 200 Series Beacon, Dual Color, FS Link, Polycarbonate permanent 1 inch pipe mount, short dome, Clear dome, Amber/White LEDs	\$225.00	\$115.62
336320	Federal Signal	220SS-AB	Spire 200 Series Beacon, Dual Color, FS Link, Suction Cup Magnetic mount, Cigarette plug, short dome, Clear dome, Amber/Blue LEDs	\$245.00	\$125.89
336320	Federal Signal	220SS-AG	Spire 200 Series Beacon, Dual Color, FS Link, Suction Cup Magnetic mount, Cigarette plug, short dome, Clear dome, Amber/Green LEDs	\$245.00	\$125.89
336320	Federal Signal	220SS-AR	Spire 200 Series Beacon, Dual Color, FS Link, Suction Cup Magnetic mount, Cigarette plug, short dome, Clear dome, Amber/Red LEDs	\$245.00	\$125.89
336320	Federal Signal	220SS-AW	Spire 200 Series Beacon, Dual Color, FS Link, Suction Cup Magnetic mount, Cigarette plug, short dome, Clear dome, Amber/White LEDs	\$245.00	\$125.89
336320	Federal Signal	220TC-AB	Spire 200 Series Beacon, Dual Color, FS Link, 1 inch pipe mount, tall dome, Clear dome, Amber/Blue LEDs	\$215.00	\$110.48
336320	Federal Signal	220TC-AG	Spire 200 Series Beacon, Dual Color, FS Link, 1 inch pipe mount, tall dome, Clear dome, Amber/Green LEDs	\$215.00	\$110.48
336320	Federal Signal	220TC-AR	Spire 200 Series Beacon, Dual Color, FS Link, 1 inch pipe mount, tall dome, Clear dome, Amber/Red LEDs	\$215.00	\$110.48
336320	Federal Signal	220TC-AW	Spire 200 Series Beacon, Dual Color, FS Link, 1 inch pipe mount, tall dome, Clear dome, Amber/White LEDs	\$215.00	\$110.48
336320	Federal Signal	220TD-AB	Spire 200 Series Beacon, Dual Color, FS Link, Die-cast permanent 1 inch pipe mount, tall dome, Clear dome, Amber/Blue LEDs	\$235.00	\$120.76
336320	Federal Signal	220TD-AG	Spire 200 Series Beacon, Dual Color, FS Link, Die-cast permanent 1 inch pipe mount, tall dome, Clear dome, Amber/Green LEDs	\$235.00	\$120.76
336320	Federal Signal	220TD-AR	Spire 200 Series Beacon, Dual Color, FS Link, Die-cast permanent 1 inch pipe mount, tall dome, Clear dome, Amber/Red LEDs	\$235.00	\$120.76
336320	Federal Signal	220TD-AW	Spire 200 Series Beacon, Dual Color, FS Link, Die-cast permanent 1 inch pipe mount, tall dome, Clear dome, Amber/White LEDs	\$235.00	\$120.76
336320	Federal Signal	220TM-AB	Spire 200 Series Beacon, Dual Color, FS Link, Magnetic mount, Cigarette plug, tall dome, Clear dome, Amber/Blue LEDs	\$235.00	\$120.76
336320	Federal Signal	220TM-AG	Spire 200 Series Beacon, Dual Color, FS Link, Magnetic mount, Cigarette plug, tall dome, Clear dome, Amber/Green LEDs	\$235.00	\$120.76
336320	Federal Signal	220TM-AR	Spire 200 Series Beacon, Dual Color, FS Link, Magnetic mount, Cigarette plug, tall dome, Clear dome, Amber/Red LEDs	\$235.00	\$120.76
336320	Federal Signal	220TM-AW	Spire 200 Series Beacon, Dual Color, FS Link, Magnetic mount, Cigarette plug, tall dome, Clear dome, Amber/White LEDs	\$235.00	\$120.76
336320	Federal Signal	220TP-AB	Spire 200 Series Beacon, Dual Color, FS Link, Polycarbonate permanent 1 inch pipe mount, tall dome, Clear dome, Amber/Blue LEDs	\$225.00	\$115.62
336320	Federal Signal	220TP-AG	Spire 200 Series Beacon, Dual Color, FS Link, Polycarbonate permanent 1 inch pipe mount, tall dome, Clear dome, Amber/Green LEDs	\$225.00	\$115.62
336320	Federal Signal	220TP-AR	Spire 200 Series Beacon, Dual Color, FS Link, Polycarbonate permanent 1 inch pipe mount, tall dome, Clear dome, Amber/Red LEDs	\$225.00	\$115.62
336320	Federal Signal	220TP-AW	Spire 200 Series Beacon, Dual Color, FS Link, Polycarbonate permanent 1 inch pipe mount, tall dome, Clear dome, Amber/White LEDs	\$225.00	\$115.62
336320	Federal Signal	220TS-AB	Spire 200 Series Beacon, Dual Color, FS Link, Suction Cup Magnetic mount, Cigarette plug, tall dome, Clear dome, Amber/Blue LEDs	\$245.00	\$125.89



336320	Federal Signal	220TS-AG	Spire 200 Series Beacon, Dual Color, FS Link, Suction Cup Magnetic mount, Cigarette plug, tall dome, Clear dome, Amber/Green LEDs	\$245.00	\$125.89
336320	Federal Signal	220TS-AR	Spire 200 Series Beacon, Dual Color, FS Link, Suction Cup Magnetic mount, Cigarette plug, tall dome, Clear dome, Amber/Red LEDs	\$245.00	\$125.89
336320	Federal Signal	220TS-AW	Spire 200 Series Beacon, Dual Color, FS Link, Suction Cup Magnetic mount, Cigarette plug, tall dome, Clear dome, Amber/White LEDs	\$245.00	\$125.89
336320	Federal Signal	22PK	Kit, Mini-AeroDync, 22", permanent mount	\$114.00	\$58.58
336320	Federal Signal	250121-02	US5,STRB,TALL,PM MNT,2F-A	\$234.00	\$120.24
336320	Federal Signal	250121-02-WP	US-5 SERIES STROBE LIGHT	\$246.00	\$126.41
336320	Federal Signal	250121-03	US5,STRB,TALL,PM MNT,2F-B	\$234.00	\$120.24
336320	Federal Signal	250121-04	US5,STRB,TALL,PM MNT,2F-R	\$234.00	\$120.24
336320	Federal Signal	250121-05	US5,STRB,TALL,PM MNT,2F-C	\$234.00	\$120.24
336320	Federal Signal	250141-02	US5,STRB,TALL,MG MNT,2F-A	\$240.00	\$123.32
336320	Federal Signal	250141-03	US5,STRB,TALL,MG MNT,2F	\$240.00	\$123.32
336320	Federal Signal	250141-04	US5,STRB,TALL,MG MNT,2F-R	\$240.00	\$123.32
336320	Federal Signal	250141-05	US5,STRB,TALL,MG MNT,2F-C	\$240.00	\$123.32
336320	Federal Signal	250721-02	US7,STRB,TALL,PM MNT-A	\$263.00	\$135.14
336320	Federal Signal	250721-05	US7,STRB,TALL,PM MNT-C	\$263.00	\$135.14
336320	Federal Signal	250741-02	US7,STRB,TALL,MG MNT-A	\$267.00	\$137.20
336320	Federal Signal	250741-05	US7,STRB,TALL,MG MNT-C	\$267.00	\$137.20
336320	Federal Signal	250821-02	US5Q,STRB,TALL,PMMNT,4F-A	\$227.00	\$116.64
336320	Federal Signal	251121-02	US5,STRB,SHORT,PMMNT,2F-A	\$234.00	\$120.24
336320	Federal Signal	251121-04	US5,STRB,SHORT,PMMNT,2F-R	\$234.00	\$120.24
336320	Federal Signal	251121-05	US5,STRB,SHORT,PMMNT,2F-C	\$220.00	\$113.05
336320	Federal Signal	251121-06	US5,STRB,SHORT,PMMNT,2F-G	\$275.00	\$141.31
336320	Federal Signal	251141-02	US5,STRB,SHORT,GMNT,2F-A	\$240.00	\$123.32
336320	Federal Signal	251821-02	US5Q,STRB,SHRT,PMMNT,4F-A	\$227.00	\$116.64
336320	Federal Signal	251821-03	US5Q,STRB,SHRT,PMMNT,	\$227.00	\$116.64
336320	Federal Signal	251821-05	US5Q,STRB,SHRT,PMMNT,4F-C	\$227.00	\$116.64
336320	Federal Signal	251841-02	US5Q,STRB,SHRT,GMNT,4F-A	\$243.00	\$124.87
336320	Federal Signal	252600-02	US6,STRB,TALL,POT,2X,PM-A	\$243.00	\$124.87
336320	Federal Signal	252601-02	US6,STRB,TALL,POT,2X,MG-A	\$315.00	\$161.86
336320	Federal Signal	252650-02SC	ULTRASTAR LED, PERM./PIPE MNT	\$259.00	\$133.09
336320	Federal Signal	252650-02SC-WP	ULTRASTAR LED, PERM./PIPE MNT	\$276.00	\$141.82
336320	Federal Signal	252651-02SC	ULTRASTAR LED, MAG. MNT	\$281.00	\$144.39
336320	Federal Signal	252654-04SC	ULTRASTAR LED, PERM./PIPE MNT	\$259.00	\$133.09
336320	Federal Signal	252655-04SC	ULTRASTAR LED, MAG. MNT	\$281.00	\$144.39
336320	Federal Signal	252657-02SC	ULTRASTAR LED, PERM./PIPE MNT	\$270.00	\$138.74
336320	Federal Signal	25-3M792H-A	792 emitter and bracket installed in JetSolaris and AeroDync lightbars	\$2,205.00	\$1,133.05
336320	Federal Signal	262650-02	SLR Beacon Amber LED's, Amber dome perm/pipe mount	\$519.00	\$266.69
336320	Federal Signal	262650-04	SLR Beacon Red LEDs, Red dome	\$519.00	\$266.69
336320	Federal Signal	262650-05	LED SOLARIS ROT. BEACON,	\$519.00	\$266.69
336320	Federal Signal	262650-25	LED SOLARIS ROT. BEACON,	\$519.00	\$266.69
336320	Federal Signal	272650-02	LED SOLARIS ROT. BEACON,	\$449.00	\$230.72
336320	Federal Signal	272650-25	Solaris LED Rotary Beacon	\$449.00	\$230.72
336320	Federal Signal	300B-SHORT	Pro LED Beacon, Branch guard, Short	\$75.00	\$38.54
336320	Federal Signal	300B-TALL	Pro LED Beacon, Branch guard, Tall	\$85.00	\$43.68
336320	Federal Signal	300SMP-A	Pro LED Beacon, Short Dome, Amber LEDs, Amber dome	\$291.00	\$149.53
336320	Federal Signal	300SMP-B	Pro LED Beacon, Short Dome, Blue LEDs, Blue dome	\$291.00	\$149.53
336320	Federal Signal	300SMPC-A	Pro LED Beacon, Short Dome, Amber LEDs, Clear dome	\$291.00	\$149.53
336320	Federal Signal	300SMPC-B	Pro LED Beacon, Short Dome, Blue LEDs, Clear dome	\$291.00	\$149.53
336320	Federal Signal	300SMPC-G	Pro LED Beacon, Short Dome, Green LEDs, Clear dome	\$329.00	\$169.06
336320	Federal Signal	300SMPC-R	Pro LED Beacon, Short Dome, Red LEDs, Clear dome	\$291.00	\$149.53
336320	Federal Signal	300SMP-G	Pro LED Beacon, Short Dome, Green LEDs, Green dome	\$329.00	\$169.06
336320	Federal Signal	300SMP-R	Pro LED Beacon, Short Dome, Red LEDs, Red dome	\$291.00	\$149.53
336320	Federal Signal	300TMP-A	Pro LED Beacon, Tall Dome, Amber LEDs, Amber dome	\$323.00	\$165.97
336320	Federal Signal	300TMP-AD-A	Pro LED Beacon, Tall Dome, Auto dimming, Amber LEDs, Amber dome	\$340.00	\$174.71
336320	Federal Signal	300TMP-AD-B	Pro LED Beacon, Tall Dome, Auto dimming, Blue LEDs, Blue dome	\$340.00	\$174.71
336320	Federal Signal	300TMP-AD-G	Pro LED Beacon, Tall Dome, Auto dimming, Green LEDs, Green dome	\$408.00	\$209.65
336320	Federal Signal	300TMP-AD-R	Pro LED Beacon, Tall Dome, Auto dimming, Red LEDs, Red dome	\$340.00	\$174.71

336320	Federal Signal	300TMP-AD-W	Pro LED Beacon, Tall Dome, Auto dimming, White LEDs, Clear dome	\$340.00	\$174.71
336320	Federal Signal	300TMP-B	Pro LED Beacon, Tall Dome, Blue LEDs, Blue dome	\$323.00	\$165.97
336320	Federal Signal	300TMPC-A	Pro LED Beacon, Tall Dome, Amber LEDs, Clear dome	\$323.00	\$165.97
336320	Federal Signal	300TMPC-AD-A	Pro LED Beacon, Tall Dome, Auto dimming, Amber LEDs, Clear dome	\$340.00	\$174.71
336320	Federal Signal	300TMPC-AD-B	Pro LED Beacon, Tall Dome, Auto dimming, Blue LEDs, Clear dome	\$340.00	\$174.71
336320	Federal Signal	300TMPC-AD-G	Pro LED Beacon, Tall Dome, Auto dimming, Green LEDs, Clear dome	\$408.00	\$209.65
336320	Federal Signal	300TMPC-AD-R	Pro LED Beacon, Tall Dome, Auto dimming, Red LEDs, Clear dome	\$340.00	\$174.71
336320	Federal Signal	300TMPC-B	Pro LED Beacon, Tall Dome, Blue LEDs, Clear dome	\$323.00	\$165.97
336320	Federal Signal	300TMPC-G	Pro LED Beacon, Tall Dome, Green LEDs, Clear dome	\$383.00	\$196.81
336320	Federal Signal	300TMPC-R	Pro LED Beacon, Tall Dome, Red LEDs, Clear dome	\$323.00	\$165.97
336320	Federal Signal	300TMP-G	Pro LED Beacon, Tall Dome, Green LEDs, Green dome	\$383.00	\$196.81
336320	Federal Signal	300TMP-R	Pro LED Beacon, Tall Dome, Red LEDs, Red dome	\$323.00	\$165.97
336320	Federal Signal	300TMP-W	Pro LED Beacon, Tall Dome, White LEDs, Clear dome	\$323.00	\$165.97
336320	Federal Signal	304301SSG	Mounting Box, 1-up pair for QL43D models	\$625.00	\$321.16
336320	Federal Signal	304302SSG	Mounting Box, 2-up pair for QL43D models	\$725.00	\$372.54
336320	Federal Signal	304303SSG	Mounting Box, 3-up pair for QL43D models	\$825.00	\$423.93
336320	Federal Signal	305101SSG	WELDMNT BOX, 1 OVAL LOC	\$295.00	\$151.59
336320	Federal Signal	305102SSG	WELDMNT BOX, 2 OVAL LOC	\$413.00	\$212.22
336320	Federal Signal	305103SSG	WELDMNT BOX, 3 OVAL LOC	\$506.00	\$260.01
336320	Federal Signal	305104SSG	1UP,POLY MNTG BOX,OVAL	\$84.00	\$43.16
336320	Federal Signal	307301SSG	QuadraFlare 7X3 DOT mounting boxes, QL73D Models, 1-up pair	\$675.00	\$346.85
336320	Federal Signal	307302SSG	QuadraFlare 7X3 DOT mounting boxes, QL73D Models, 2 up pair	\$825.00	\$423.93
336320	Federal Signal	307303SSG	QuadraFlare 7X3 DOT mounting boxes, QL73D Models, 3 up pair	\$900.00	\$462.47
336320	Federal Signal	320810-42	Viper, SignalMaster, 42"	\$1,597.00	\$820.62
336320	Federal Signal	320810-BAB	VPX SignalMaster 42", (8) lamp, 30-ft cable, B-A-A-A-A-A-A-B	\$1,535.00	\$788.77
336320	Federal Signal	320810-RAR	VPX SignalMaster 42", (8) lamp, 30-ft cable, R-A-A-A-A-A-A-R	\$1,647.00	\$846.32
336320	Federal Signal	320810-RB	VPX SignalMaster 42", (8) lamp, 30-ft cable, R-A-A-A-A-A-A-B	\$1,535.00	\$788.77
336320	Federal Signal	320862-04	VPX SIGM,6HD,31",30'CABLE	\$1,329.00	\$682.91
336320	Federal Signal	320862-RAB	VPX SIGM, 6HD, 31"	\$1,329.00	\$682.91
336320	Federal Signal	320SMP-AB	Pro LED Beacon, Short Dome, Amber/Blue LEDs, Clear dome	\$355.00	\$182.42
336320	Federal Signal	320SMP-AG	Pro LED Beacon, Short Dome, Amber/Green LEDs, Clear dome	\$405.00	\$208.11
336320	Federal Signal	320SMP-AR	Pro LED Beacon, Short Dome, Amber/Red LEDs, Clear dome	\$355.00	\$182.42
336320	Federal Signal	320SMP-AW	Pro LED Beacon, Short Dome, Amber/White LEDs, Clear dome	\$355.00	\$182.42
336320	Federal Signal	320TMP-AD-AB	Pro LED Beacon, Tall Dome, Auto dimming, Amber/Blue LEDs, Clear dome	\$425.00	\$218.39
336320	Federal Signal	320TMP-AD-AG	Pro LED Beacon, Tall Dome, Auto dimming, Amber/Green LEDs, Clear dome	\$492.00	\$252.82
336320	Federal Signal	320TMP-AD-AR	Pro LED Beacon, Tall Dome, Auto dimming, Amber/Red LEDs, Clear dome	\$425.00	\$218.39
336320	Federal Signal	320TMP-AD-AW	Pro LED Beacon, Tall Dome, Auto dimming, Amber/White LEDs, Clear dome	\$425.00	\$218.39
336320	Federal Signal	320TMP-AG	Pro LED Beacon, Tall Dome, Amber/Green LEDs, Clear dome	\$492.00	\$252.82
336320	Federal Signal	320TMP-AR	Pro LED Beacon, Tall Dome, Amber/Red LEDs, Clear dome	\$408.00	\$209.65
336320	Federal Signal	320TMP-AW	Pro LED Beacon, Tall Dome, Amber/White LEDs, Clear dome	\$408.00	\$209.65
336320	Federal Signal	321712-C	LED ECONOMY DIR LT SYS,51	\$815.00	\$418.79
336320	Federal Signal	330104-SB	Basic directional Light controller, for use with 4,6,8 head models, 12 or 24VCC	\$288.00	\$147.99
336320	Federal Signal	331105-SB	Full featured directional light controller for use with 4,6,8 head models, 12 or 24 VDC (slide switch, multiple installer selectable flash patterns, heavy duty ground, fuse protected, controls two SignalMasters simultaneously)	\$351.00	\$180.36
336320	Federal Signal	350172-25	AMB LED,CLR LENS W/OVAL	\$215.00	\$110.48
336320	Federal Signal	350701-01	Viper S2 Bracket, rear deck brake light/dual, Crown Victoria	\$30.00	\$15.42
336320	Federal Signal	350701-02	Viper S2 Bracket, rear view mirror/headliner/single, Crown Victoria	\$30.00	\$15.42
336320	Federal Signal	350701-03	Viper S2 Bracket, rear view mirror/headliner/dual, Crown Victoria	\$30.00	\$15.42
336320	Federal Signal	350701-04	Viper S2 Bracket, rear view mirror/headliner/single, 2013 Ford Interceptor Sedan and Utility	\$25.00	\$12.85
336320	Federal Signal	350701-05	Viper S2 Bracket, rear view mirror/headliner/dual, 2013 Ford Interceptor Sedan and Utility	\$30.00	\$15.42

336320	Federal Signal	350701-06	Viper S2 Bracket, rear deck single, 2013 Ford Interceptor Sedan	\$30.00	\$15.42
336320	Federal Signal	350701-07	Viper S2 Bracket, rear deck dual, 2013 Ford Interceptor Sedan	\$30.00	\$15.42
336320	Federal Signal	360401-03	SMART 3600,B/B,WIDE	\$190.00	\$97.63
336320	Federal Signal	360401-04	SMART 3600,RED/RED,WIDE	\$165.00	\$84.79
336320	Federal Signal	360411-04	SMART 3600,RED/CLR,WIDE	\$165.00	\$84.79
336320	Federal Signal	3M792H	792 Opticom strobe emitter, suitable for external use	\$2,193.00	\$1,126.88
336320	Federal Signal	412027-02	MODEL 651,STRB,115V,AC-A	\$273.00	\$140.28
336320	Federal Signal	412027-04	MODEL 651,STRB,115V,AC-R	\$273.00	\$140.28
336320	Federal Signal	412027-05	MODEL 651 STRB 115V A	\$263.00	\$135.14
336320	Federal Signal	412046-02	MODEL 851RR,STRB,72V-A	\$347.00	\$178.31
336320	Federal Signal	412047-04	Model 851 Strobe, 115V, AC-R	\$322.00	\$165.46
336320	Federal Signal	412048-02	MODEL851 STRB 115V PI	\$334.00	\$171.63
336320	Federal Signal	412067-02	MODEL 951,STRB,115V-A	\$334.00	\$171.63
336320	Federal Signal	412067-04	MODEL 951,STRB,115V-R	\$319.00	\$163.92
336320	Federal Signal	413201-02	Corner strobe tube Amber	\$74.00	\$38.03
336320	Federal Signal	413201-03	Corner strobe tube Blue	\$74.00	\$38.03
336320	Federal Signal	413201-04	Corner strobe tube Red	\$74.00	\$38.03
336320	Federal Signal	413201-05	Corner strobe tube Clear	\$45.00	\$23.12
336320	Federal Signal	413222B	Corner LED Cable 25-ft length	\$46.00	\$23.64
336320	Federal Signal	413300-02	Corner strobe tube Amber	\$76.00	\$39.05
336320	Federal Signal	413300-05	Corner strobe tube Clear	\$46.00	\$23.64
336320	Federal Signal	415010-02SC	TURBOBEAM 00,15"-A	\$280.00	\$143.88
336320	Federal Signal	415011-02SC	TURBOBEAM 00,15"-A	\$302.00	\$155.18
336320	Federal Signal	415011-04SC	TURBOBEAM 00,15"-R	\$302.00	\$155.18
336320	Federal Signal	415111-02SC	TURBOBEAM 00,22"-A	\$280.00	\$143.88
336320	Federal Signal	415111-04SC	TURBOBEAM 00,22"-R	\$280.00	\$143.88
336320	Federal Signal	415111-242SC	TURBOBEAM 00,22"-ARA	\$280.00	\$143.88
336320	Federal Signal	415111-454SC	TURBOBEAM 00,22"-RCR	\$302.00	\$155.18
336320	Federal Signal	415510-02SB	TURBOBEAM 00,15"-A	\$390.00	\$200.40
336320	Federal Signal	415511-02	TURBOBM00,15",ISO.ROT	\$440.00	\$226.10
336320	Federal Signal	415611-02SB	TURBOBEAM 00,22"-A	\$429.00	\$220.44
336320	Federal Signal	415611-04SB	TURBOBEAM 00,22"-R	\$484.00	\$248.71
336320	Federal Signal	416119B	(1) 660L, (4) Clear corner tubes, (2) 10-ft cables, (2) 25-ft cables	\$571.00	\$293.41
336320	Federal Signal	416125B	(1) SS4A, (4) Clear corner tubes, (2) 10-ft cables, (2) 25-ft cables	\$398.00	\$204.51
336320	Federal Signal	416126-02	SS4W PWR SPLY KIT W/TUBES	\$537.00	\$275.94
336320	Federal Signal	416128-02	SS4W PWR SPLY KIT W/TUBES	\$523.00	\$268.75
336320	Federal Signal	416129-25	SS4A PWR SPLY KIT W/TUBES	\$456.00	\$234.32
336320	Federal Signal	416300-A	(3) LED light head, Amber	\$99.00	\$50.87
336320	Federal Signal	416300-AW	(6) LEDs, Amber/White, Flush mount, Dual Color, Clear Lens, 12/24Vdc	\$109.00	\$56.01
336320	Federal Signal	416300-B	(3) LED light head, Blue	\$99.00	\$50.87
336320	Federal Signal	416300-BA	(6) LEDs, Blue/Amber, Flush mount, Dual Color, Clear Lens, 12/24Vdc	\$109.00	\$56.01
336320	Federal Signal	416300-BW	(6) LEDs, Blue/White, Flush mount, Dual Color, Clear Lens, 12/24Vdc	\$109.00	\$56.01
336320	Federal Signal	416300-R	(3) LED light head, Red	\$99.00	\$50.87
336320	Federal Signal	416300-RA	(6) LEDs, Red/Amber, Flush mount, Dual Color, Clear Lens, 12/24Vdc	\$109.00	\$56.01
336320	Federal Signal	416300-RB	(6) LEDs, Red/Blue, Flush mount, Dual Color, Clear Lens, 12/24Vdc	\$109.00	\$56.01
336320	Federal Signal	416300-RW	(6) LEDs, Red/White, Flush mount, Dual Color, Clear Lens, 12/24Vdc	\$109.00	\$56.01
336320	Federal Signal	416300-W	(3) LED light head, White	\$99.00	\$50.87
336320	Federal Signal	416300X-B	416300 Series, steady burn, single color, surface mount, 12 VDC, 3 LED light head, Blue	\$99.00	\$50.87
336320	Federal Signal	416300X-BW	(6) LEDs, Blue/White, Flush mount, Dual Color, Clear Lens, Steady Burn, 12/24Vdc	\$109.00	\$56.01
336320	Federal Signal	416300X-R	416300 Series, steady burn, single color, surface mount, 12 VDC, 3 LED light head, Red.	\$99.00	\$50.87
336320	Federal Signal	416300X-RB	(6) LEDs, Red/Blue, Flush mount, Dual Color, Clear Lens, Steady Burn, 12/24Vdc	\$109.00	\$56.01
336320	Federal Signal	416300X-RW	(6) LEDs, Red/White, Flush mount, Dual Color, Clear Lens, Steady Burn, 12/24Vdc	\$109.00	\$56.01
336320	Federal Signal	416400-BW	Corner LED, Blue/White	\$154.00	\$79.13
336320	Federal Signal	416400-RB	Corner LED, Red/Blue	\$154.00	\$79.13
336320	Federal Signal	416410-B	Corner LED, Blue	\$154.00	\$79.13
336320	Federal Signal	416410-R	Corner LED, Red	\$154.00	\$79.13

336320	Federal Signal	416499-RW	Corner LED, Red/White	\$154.00	\$79.13
336320	Federal Signal	416800-BWBW	Ford Corner LED Sys., Dual color	\$250.00	\$128.46
336320	Federal Signal	416800-RBRB	Ford Corner LED System, Dual Color	\$250.00	\$128.46
336320	Federal Signal	416800-RWBW	Ford Corner LED Sys., Dual color	\$250.00	\$128.46
336320	Federal Signal	416800-RWRW	Ford Corner LED Sys., Dual color	\$250.00	\$128.46
336320	Federal Signal	416801-BW	Twist-n-Lock Corner LED, Dual color, Lighthouse, B/W	\$80.00	\$41.11
336320	Federal Signal	416801-RB	Twist-n-Lock Corner LED, Dual color, Lighthouse, R/B	\$80.00	\$41.11
336320	Federal Signal	416801-RW	Twist-n-Lock Corner LED, Dual color, Lighthouse,R/W	\$80.00	\$41.11
336320	Federal Signal	416810-BB	Ford Corner LED System, Single Color	\$250.00	\$128.46
336320	Federal Signal	416810-RB	Ford Corner LED Sys., Single color	\$250.00	\$128.46
336320	Federal Signal	416810-RR	Ford Corner LED System, Single Color	\$250.00	\$128.46
336320	Federal Signal	416810-WW	Ford Corner LED System, Single Color	\$250.00	\$128.46
336320	Federal Signal	416811-B	Twist-n-Lock Corner LED, Single color, Lighthouse, Blue	\$80.00	\$41.11
336320	Federal Signal	416811-R	Twist-n-Lock Corner LED, Single color, Lighthouse, Red	\$80.00	\$41.11
336320	Federal Signal	416811-W	Twist-n-Lock Corner LED, Single color, Lighthouse, White	\$75.00	\$38.54
336320	Federal Signal	416900-VHB	3M VHB no-drill mount for 2020 Ford Interceptor Utility with standard headlight assembly or taillight when Ford option 86T is ordered, 4 pack.	\$15.00	\$7.71
336320	Federal Signal	416900X-RB	Dual; Corner LEDs, X Inline	\$109.00	\$56.01
336320	Federal Signal	416900XZ-BW	Steady Burn, Dual color, single head in line Corner LED, with in-line flasher, cables, and black bezel, Blue/White	\$109.00	\$56.01
336320	Federal Signal	416900XZ-RW	Steady Burn, Dual color, single head in line Corner LED, with in-line flasher, cables, and black bezel, Red/White	\$109.00	\$56.01
336320	Federal Signal	416900Z-AW	Dual color, single head in line Corner LED, with in-line flasher, cables, and black bezel, Amber/White	\$109.00	\$56.01
336320	Federal Signal	416900Z-BA	Dual color, single head in line Corner LED, with in-line flasher, cables, and black bezel, Blue/Amber	\$109.00	\$56.01
336320	Federal Signal	416900Z-BW	Dual color, single head in line Corner LED, with in-line flasher, cables, and black bezel, Blue/White	\$109.00	\$56.01
336320	Federal Signal	416900Z-RA	Dual color, single head in line Corner LED, with in-line flasher, cables, and black bezel, Red/Amber	\$109.00	\$56.01
336320	Federal Signal	416900Z-RB	Dual color, single head in line Corner LED, with in-line flasher, cables, and black bezel, Red/Blue	\$109.00	\$56.01
336320	Federal Signal	416900Z-RW	Dual color, single head in line Corner LED, with in-line flasher, cables, and black bezel, Red/White	\$109.00	\$56.01
336320	Federal Signal	416910Z-A	Single color, single head in line Corner LED, with in-line flasher, cables, and black bezel, Amber	\$109.00	\$56.01
336320	Federal Signal	416910Z-B	Single color, single head in line Corner LED, with in-line flasher, cables, and black bezel, Blue	\$109.00	\$56.01
336320	Federal Signal	416910Z-R	Single color, single head in line Corner LED, with in-line flasher, cables, and black bezel, Red	\$109.00	\$56.01
336320	Federal Signal	416910Z-W	Single color, single head in line Corner LED, with in-line flasher, cables, and black bezel, White	\$109.00	\$56.01
336320	Federal Signal	416-BZ100-BLK	Kit, Bezel, Black, 416 Corner LEDs	\$525.00	\$269.77
336320	Federal Signal	416-BZ100-CHROME	Kit, Bezel, Chrome, 416 Corner LEDs	\$775.00	\$398.24
336320	Federal Signal	416BZ100-WHT	Kit, Bezel, White, 416 Corner LEDs	\$600.00	\$308.31
336320	Federal Signal	4200S-2	Perimeter Light, Amber	\$55.00	\$28.26
336320	Federal Signal	4200S-A	Perimeter Light, White	\$57.00	\$29.29
336320	Federal Signal	4200S-W	Exterior Mount Perimeter Lights, Single color, clear lens, 4 LED head, white	\$57.00	\$29.29
336320	Federal Signal	420200-02	MODEL 651,STRB,2F-A	\$219.00	\$112.53
336320	Federal Signal	420222-02	651 UTILITY LED LIGHT	\$219.00	\$112.53
336320	Federal Signal	420223-02	651 LED LIGHT	\$189.00	\$97.12
336320	Federal Signal	420450-02	851 LED LIGHT	\$189.00	\$97.12
336320	Federal Signal	420460-02	851 LED UTILITY LIGHT	\$219.00	\$112.53
336320	Federal Signal	4300SS	QL43 Quad Box, Single	\$395.00	\$202.97
336320	Federal Signal	439231-95	REPL BULB,H1,24V,70W	\$26.00	\$13.36
336320	Federal Signal	439238-95	LAMP,HALOGEN,55W	\$33.00	\$16.96
336320	Federal Signal	439290-95	REPL FLASH TUBE,551HD	\$55.00	\$28.26
336320	Federal Signal	439385C-01-95	REPL,LBAR ASSY,901,2X-A	\$273.00	\$140.28
336320	Federal Signal	439411-95	REPL FLASH TUBE,451HD	\$53.00	\$27.23
336320	Federal Signal	442112-02	MDL100F,ROT,12V,175F-A	\$172.00	\$88.38
336320	Federal Signal	442112-04	MDL100F,ROT,12V,175F-R	\$172.00	\$88.38
336320	Federal Signal	442114-02	MDL100F,ROT,24V,175F-A	\$181.00	\$93.01
336320	Federal Signal	443112-02	MDL100,ROT,12V,95F-A	\$172.00	\$88.38
336320	Federal Signal	443112-03	MDL100,ROT,12V,95F-B	\$172.00	\$88.38
336320	Federal Signal	443112-04	MDL100,ROT,12V,95F-R	\$172.00	\$88.38
336320	Federal Signal	443114-02	MDL100,ROT,24V,95F-A	\$181.00	\$93.01
336320	Federal Signal	443114-04	MDL100,ROT,24V,95F-R	\$181.00	\$93.01

336320	Federal Signal	443212-02	MDL100,ROT,12V,95F,MAG-A	\$179.00	\$91.98
336320	Federal Signal	443312-02	MDL100,12V,REPL BULB-A	\$183.00	\$94.04
336320	Federal Signal	443314-02	MDL100,24V,REPL BULB-A	\$194.00	\$99.69
336320	Federal Signal	448112-02	Sentry SY12SS, 95 FPM rotator, permanent mount, Amber; -03(Blue); -04(Red); -05(Clear)	\$160.00	\$82.22
336320	Federal Signal	448112-03	MDLSY,ROT,12V,95F,PERM-B	\$158.00	\$81.19
336320	Federal Signal	448112-04	MDLSY,ROT,12V,95F,PERM-R	\$158.00	\$81.19
336320	Federal Signal	448112-06	MDLSY,ROT,12V,95F,PERM-G	\$132.00	\$67.83
336320	Federal Signal	448114-02	MDLSY,ROT,24V,95F,PERM-A	\$169.00	\$86.84
336320	Federal Signal	448142-02	Sentry SY12SM, 95 FPM rotator, magnetic mount, Amber; -03(Blue); -04(Red); -05(Clear)	\$159.00	\$81.70
336320	Federal Signal	448142-03	MDLSY,ROT,12V,95F,MAG-B	\$159.00	\$81.70
336320	Federal Signal	448142-06	MDLSY,ROT,12V,95F,MAG-G	\$150.00	\$77.08
336320	Federal Signal	448500-02	REPL DOME,SENTRY-A	\$24.00	\$12.33
336320	Federal Signal	448500-03	REPL DOME,SENTRY-B	\$24.00	\$12.33
336320	Federal Signal	448500-04	REPL DOME,SENTRY-R	\$24.00	\$12.33
336320	Federal Signal	448500-05	REPL DOME,SENTRY-C	\$24.00	\$12.33
336320	Federal Signal	448572SSG	REPL ROT,12V,95F,SY/HL	\$52.00	\$26.72
336320	Federal Signal	449112-02	Sentry SY12FS, 175 FPM rotator, permanent mount, Amber; -03(Blue); -04(Red); -05(Clear)	\$160.00	\$82.22
336320	Federal Signal	449112-03	MDLSY,ROT,12V,175F,PERM-B	\$140.00	\$71.94
336320	Federal Signal	449112-04	MDLSY,ROT,12V,175F,PERM-R	\$140.00	\$71.94
336320	Federal Signal	449122-02	MDLSY,ROT,12V,175F,PIPE-A	\$145.00	\$74.51
336320	Federal Signal	449142-02	Sentry SY12FM, 175 FPM rotator, magnetic mount, Amber; -03(Blue); -04(Red); -05(Clear)	\$160.00	\$82.22
336320	Federal Signal	449142-03	MDLSY,ROT,12V,175F,MAG-B	\$156.00	\$80.16
336320	Federal Signal	450112-02	MDLHL,MINI,12V,2ROT-A	\$241.00	\$123.84
336320	Federal Signal	450114-02	MDLHL24,MINI,24V,2ROT-A	\$241.00	\$123.84
336320	Federal Signal	450152-02	MDLHL,MINI,12V,(2)120F-A	\$246.00	\$126.41
336320	Federal Signal	450162-02	HLM,12V,(2)120F,DIAG,MG-A	\$299.00	\$153.64
336320	Federal Signal	451112-02	MDLHL,FAST,12V,2FROT-A	\$257.00	\$132.06
336320	Federal Signal	451112-05	MDLHL,MINI,12V,2FROT-C	\$230.00	\$118.19
336320	Federal Signal	451412-02	MDLHLMFAST,12V,2FROT,MG-A	\$325.00	\$167.00
336320	Federal Signal	452112-02	MDLHL,MINI,12V,2ROT,DM-A	\$257.00	\$132.06
336320	Federal Signal	452142-02	HLM,12V,(2)95F,DIAG,MG-A	\$278.00	\$142.85
336320	Federal Signal	452142-03	HLM,12V,(2)95F,DIAG,MG-B	\$278.00	\$142.85
336320	Federal Signal	452142-05	HLM 12V (2)95F DIAG M	\$275.00	\$141.31
336320	Federal Signal	452412-02	2 175 FPM ROTATORS, DIAGONAL MIRROR, AMBER, MAGNETIC MOUNT, INCLUDES CIGARETTE PLUG WITH ON/OFF SWITCH	\$288.00	\$147.99
336320	Federal Signal	452510-02	REPL DOME,HIGHLIGHTER-A	\$43.00	\$22.10
336320	Federal Signal	452510-03	REPL DOME,HIGHLIGHTER-B	\$43.00	\$22.10
336320	Federal Signal	452510-05	REPL DOME,HIGHLIGHTER-C	\$42.00	\$21.58
336320	Federal Signal	452643-02	HLM,12V,(2)95F,DIAM,MG-A	\$260.00	\$133.60
336320	Federal Signal	454100HL-02	HighLighter LED - suction cup magnet mount, Amber dome, amber LEDs	\$377.00	\$193.72
336320	Federal Signal	454100HL-25	HighLighter LED - suction cup magnet mount, clear dome, amber LEDs	\$377.00	\$193.72
336320	Federal Signal	454100HL-AWA	Highlighter, Amber / White LED mini-lightbar - Clear dome, Amber/White LEDs, Suction-cup mount with cigarette plug.	\$377.00	\$193.72
336320	Federal Signal	454101HL-02	HighLighter LED - permanent mount, amber dome, amber LEDs	\$333.00	\$171.11
336320	Federal Signal	454101HL-03	HighLighter LED, permanent mount	\$333.00	\$171.11
336320	Federal Signal	454101HL-04	HighLighter LED - permanent mount, red dome, red LEDs	\$333.00	\$171.11
336320	Federal Signal	454101HL-25	HighLighter LED - permanent mount, clear dome, amber LEDs	\$333.00	\$171.11
336320	Federal Signal	454101HL-AGA	HighLighter LED, Amber/Green/Amber LEDs, Clear dome, Permanent mount	\$333.00	\$171.11
336320	Federal Signal	454101HL-AWA	Highlighter, Amber / White LED mini-lightbar - Clear dome, Amber/White LEDs, Permanent mount	\$333.00	\$171.11
336320	Federal Signal	454102HL-02	HighLighter LED - magnet mount with cig plug, amber dome, amber LEDs	\$355.00	\$182.42
336320	Federal Signal	454102HL-25	HighLighter LED - magnet mount with cig plug, clear dome, amber LEDs	\$355.00	\$182.42
336320	Federal Signal	454200-24-02SC	24V LED HL,SUCTN MNT-A/A	\$687.00	\$353.02
336320	Federal Signal	454200-24-03SC	24V LED HL,SUCTN MNT-B/B	\$687.00	\$353.02
336320	Federal Signal	454200-24-04SC	24V LED HL,SUCTN MNT-R/R	\$687.00	\$353.02
336320	Federal Signal	454200-24-25SC	24V LED HL,SUCTN MNT-A/C	\$687.00	\$353.02
336320	Federal Signal	454200-24-35SC	24V LED HL,SUCTN MNT-B/C	\$687.00	\$353.02
336320	Federal Signal	454200-24-45SC	24V LED HL,SUCTN MNT-R/C	\$687.00	\$353.02

336320	Federal Signal	454200HL-02	HighLighter LED Plus-suction cup magnet mount, amber dome, amber LEDs	\$557.00	\$286.22
336320	Federal Signal	454200HL-03	HighLighter LED Plus-suction cup magnet mount, blue dome, blue LEDs	\$557.00	\$286.22
336320	Federal Signal	454200HL-04	HighLighter LED Plus-suction cup magnet mount, red dome, red LEDs	\$557.00	\$286.22
336320	Federal Signal	454200HL-05	HighLighter LED Plus-suction cup magnet mount, clear done, white LEDs	\$557.00	\$286.22
336320	Federal Signal	454200HL-25	HighLighter LED Plus-suction cup magnet mount, clear dome, amber LEDs	\$557.00	\$286.22
336320	Federal Signal	454200HL-35	HighLighter LED Plus-suction cup magnet mount, clear dome, blue LEDs	\$557.00	\$286.22
336320	Federal Signal	454200HL-45	HighLighter LED Plus-suction cup magnet mount, clear dome, red LEDs	\$557.00	\$286.22
336320	Federal Signal	454201-24-02SC	24V LED HL,PERM MNT-A/A	\$642.00	\$329.89
336320	Federal Signal	454201-24-03SC	24V LED HL,PERM MNT-B/B	\$642.00	\$329.89
336320	Federal Signal	454201-24-04SC	24V LED HL,PERM MNT-R/R	\$642.00	\$329.89
336320	Federal Signal	454201-24-05SC	24V LED HL,PERM MNT-W/C	\$642.00	\$329.89
336320	Federal Signal	454201-24-25SC	24V LED HL,PERM MNT-A/C	\$642.00	\$329.89
336320	Federal Signal	454201-24-35SC	24V LED HL,PERM MNT-B/C	\$642.00	\$329.89
336320	Federal Signal	454201-24-45SC	24V LED HL,PERM MNT-R/C	\$642.00	\$329.89
336320	Federal Signal	454201-24-65SC	24V LED HL,PERM MNT-G/C	\$665.00	\$341.71
336320	Federal Signal	454201HL-02	HighLighter LED Plus - permanent mount, amber dome, amber LEDs	\$513.00	\$263.61
336320	Federal Signal	454201HL-03	HighLighter LED Plus - permanent mount, blue dome, blue LEDs	\$513.00	\$263.61
336320	Federal Signal	454201HL-04	HighLighter LED Plus - permanent mount, red dome, red LEDs	\$513.00	\$263.61
336320	Federal Signal	454201HL-05	HighLighter LED Plus - permanent mount, clear dome, white LEDs	\$513.00	\$263.61
336320	Federal Signal	454201HL-25	HighLighter LED Plus - permanent mount, clear dome, amber LEDs	\$513.00	\$263.61
336320	Federal Signal	454201HL-35	HighLighter LED Plus - permanent mount, clear dome, blue LEDs	\$513.00	\$263.61
336320	Federal Signal	454201HL-45	HighLighter LED Plus - permanent mount, clear dome, red LEDs	\$513.00	\$263.61
336320	Federal Signal	454202-24-02SC	24V LED HL,MAG MNT-A/A	\$665.00	\$341.71
336320	Federal Signal	454202-24-04SC	24V LED HL,MAG MNT-R/R	\$665.00	\$341.71
336320	Federal Signal	454202-24-25SC	24V LED HL,MAG MNT-A/C	\$665.00	\$341.71
336320	Federal Signal	454202-24-35SC	24V LED HL,MAG MNT-B/C	\$665.00	\$341.71
336320	Federal Signal	454202-24-45SC	24V LED HL,MAG MNT-R/C	\$665.00	\$341.71
336320	Federal Signal	454202HL-02	HighLighter LED Plus - mag. mount with cig plug, amber dome, amber LEDs	\$535.00	\$274.91
336320	Federal Signal	454202HL-03	HighLighter LED Plus - mag. mount with cig plug, blue dome, blue LEDs	\$535.00	\$274.91
336320	Federal Signal	454202HL-04	HighLighter LED Plus - mag. mount with cig plug, red dome, red LEDs	\$535.00	\$274.91
336320	Federal Signal	454202HL-05	HighLighter LED Plus - mag. mount with cig plug, clear dome, white LEDs	\$535.00	\$274.91
336320	Federal Signal	454202HL-25	HighLighter LED Plus - mag. mount with cig plug, clear dome, amber LEDs	\$535.00	\$274.91
336320	Federal Signal	454202HL-35	HighLighter LED Plus - mag. mount with cig plug, clear dome, blue LEDs	\$535.00	\$274.91
336320	Federal Signal	454202HL-45	HighLighter LED Plus - mag. mount with cig plug, clear dome, red LEDs	\$535.00	\$274.91
336320	Federal Signal	454300HL-AAA	Highlighter LED Pro, suction cup magnet mount, cigarette plug, clear dome, Amber LEDs	\$666.00	\$342.23
336320	Federal Signal	454300HL-AGA	HighLighter LED Pro, Suction cup magnet mount, cigarette plus, on/off switch, Clear dome	\$666.00	\$342.23
336320	Federal Signal	454300HL-AWA	CLEAR DOME, AWAAAWAA, SUCTION CUP MAGNET MOUNT, INCLUDES CIGARETTE PLUG WITH ON/OFF SWITCH	\$666.00	\$342.23
336320	Federal Signal	454301-AAA-SYNC	HighLighter LED Pro, Permanent mount, cigarette plus, on/off switch, Clear dome, sync out option	\$604.00	\$310.37
336320	Federal Signal	454301HL-AAA	Highlighter LED Pro, permanent mount, clear dome, Amber LEDs	\$622.00	\$319.62
336320	Federal Signal	454301HL-ABS	Highlighter LED Pro, permanent mount, clear dome, Amber/Blue LEDs	\$622.00	\$319.62
336320	Federal Signal	454301HL-AWA	Permanent mount, Amber/White/Amber LEDs, Clear dome	\$622.00	\$319.62
336320	Federal Signal	454301HL-AWA-SYNC	HighLighter LED Pro, Permanent mount, cigarette plus, on/off switch, Clear dome, sync out option	\$604.00	\$310.37
336320	Federal Signal	454301HL-RA	HighLighter LED Pro, Clear Done, Permanent Mount, Red/Amber	\$604.00	\$310.37

336320	Federal Signal	454301HL-RRR	HighLighter LED Pro, Clear Dome, Permanent Mount, Red/Red/Red	\$604.00	\$310.37
336320	Federal Signal	454301HL-RWA	HighLighter LED Pro, Clear Dome, Permanent Mount, Red/White/Amber	\$604.00	\$310.37
336320	Federal Signal	454301HL-RWR	HighLighter LED Pro, Clear Dome, Permanent Mount, Red/White/Red	\$604.00	\$310.37
336320	Federal Signal	454301HLS-AAA-SYNC	Permanent mount, Amber LEDs, Clear dome, "synch out" option	\$622.00	\$319.62
336320	Federal Signal	454301HLS-AWA-SYNC	Permanent mount, Amber/White/Amber LEDs, Clear dome, "synch out" option	\$622.00	\$319.62
336320	Federal Signal	454302-AGA	HighLighter LED Pro, magnet mount, cigarette plus, on/off switch, Clear dome	\$644.00	\$330.92
336320	Federal Signal	454302HL-AAA	HighLighter LED Pro, magnet mount, cigarette plug, on/off switch, clear dome, Amber LEDs	\$644.00	\$330.92
336320	Federal Signal	454302HL-ABS	HighLighter LED Pro, magnet mount, cigarette plug, on/off switch, clear dome, Amber/Blue LEDs	\$644.00	\$330.92
336320	Federal Signal	454302HL-AWA	CLEAR DOME, AWAAAWAA, MAGNETIC MOUNT, INCLUDES CIGARETTE PLUG WITH ON/OFF SWITCH.	\$644.00	\$330.92
336320	Federal Signal	454400HL-AB	Suction cup magnet mount, cigarette plug, on/off switch, FSLink, Clear dome, Amber/Blue LEDs	\$618.00	\$317.56
336320	Federal Signal	454400HL-AG	Suction cup magnet mount, cigarette plug, on/off switch, FSLink, Clear dome, Amber/Green LEDs	\$618.00	\$317.56
336320	Federal Signal	454400HL-AR	Suction cup magnet mount, cigarette plug, on/off switch, FSLink, Clear dome, Amber/Red LEDs	\$618.00	\$317.56
336320	Federal Signal	454400HL-AW	Suction cup magnet mount, cigarette plug, on/off switch, FSLink, Clear dome, Amber/White LEDs	\$618.00	\$317.56
336320	Federal Signal	454401HL-AB	Permanent mount, FSLink, Clear dome, Amber/Blue LEDs	\$568.00	\$291.87
336320	Federal Signal	454401HL-AG	Permanent mount, FSLink, Clear dome, Amber/Green LEDs	\$568.00	\$291.87
336320	Federal Signal	454401HL-AR	Permanent mount, FSLink, Clear dome, Amber/Red LEDs	\$568.00	\$291.87
336320	Federal Signal	454401HL-AW	Permanent mount, FSLink, Clear dome, Amber/White LEDs	\$568.00	\$291.87
336320	Federal Signal	454402HL-AB	Magnet mount, cigarette plug, on/off switch, FSLink, Clear dome, Amber/Blue LEDs	\$598.00	\$307.28
336320	Federal Signal	454402HL-AG	Magnet mount, cigarette plug, on/off switch, FSLink, Clear dome, Amber/Green LEDs	\$598.00	\$307.28
336320	Federal Signal	454402HL-AR	Magnet mount, cigarette plug, on/off switch, FSLink, Clear dome, Amber/Red LEDs	\$598.00	\$307.28
336320	Federal Signal	454402HL-AW	Magnet mount, cigarette plug, on/off switch, FSLink, Clear dome, Amber/White LEDs	\$598.00	\$307.28
336320	Federal Signal	462121-02	RENEGADE,12-48V,PM/PIPE-A	\$121.00	\$62.18
336320	Federal Signal	462121-03	RENEGADE,12-48V,PM/PIPE-B	\$121.00	\$62.18
336320	Federal Signal	462121-04	RENEGADE,12-48V,PM/PIPE-R	\$121.00	\$62.18
336320	Federal Signal	462121-05	RENEGADE,12-48V,PM/PIPE-C	\$121.00	\$62.18
336320	Federal Signal	462121-06	RENEGADE,12-48V,PM/PIPE-G	\$121.00	\$62.18
336320	Federal Signal	462141-02	RENEGADE,12-48V,MAG-A	\$176.00	\$90.44
336320	Federal Signal	462141-03	RENEGADE,12-48V,MAG-B	\$176.00	\$90.44
336320	Federal Signal	462141-04	RENEGADE,12-48V,MAG-R	\$177.00	\$90.95
336320	Federal Signal	462500-02	REPL DOME,RENEGADE-A	\$21.00	\$10.79
336320	Federal Signal	462500-03	REPL DOME,RENEGADE-B	\$21.00	\$10.79
336320	Federal Signal	462500-04	REPL DOME,RENEGADE-R	\$21.00	\$10.79
336320	Federal Signal	500435SSG	4" RISER MOUNT KIT,LEGEND	\$88.00	\$45.22
336320	Federal Signal	521500-02	REPL END DOME,JET-A	\$144.00	\$73.99
336320	Federal Signal	521500-04	REPL END DOME,JET-R	\$144.00	\$73.99
336320	Federal Signal	521500-05	REPL END DOME,JET-C	\$144.00	\$73.99
336320	Federal Signal	521501-02	REPL CENTER DOME,JET-A	\$36.00	\$18.50
336320	Federal Signal	521501-05	REPL CENTER DOME,JET-C	\$36.00	\$18.50
336320	Federal Signal	601102-02	OVAL WEATHERPACK STRB-A	\$85.00	\$43.68
336320	Federal Signal	601103-02	OVAL IND.STND,AMP,STRB-A	\$62.00	\$31.86
336320	Federal Signal	601103-05	OVAL IND.STND,AMP,STRB-C	\$62.00	\$31.86
336320	Federal Signal	601111-02	OVAL DEUTSCHE STROBE-A	\$78.00	\$40.08
336320	Federal Signal	601125-02	ROUND IND.STND,AMP,STRB-A	\$70.00	\$35.97
336320	Federal Signal	601330SSG	HEAVY METAL MOUNT,601101	\$183.00	\$94.04
336320	Federal Signal	601512-95	REPL FLASH TUBE,601111	\$56.00	\$28.78
336320	Federal Signal	601513-95	REPL FLASH TUBE,601101	\$46.00	\$23.64
336320	Federal Signal	601515-95	REPL FLASH TUBE,601102	\$81.00	\$41.62
336320	Federal Signal	601516-95	REPL FLASH TUBE,601123	\$73.00	\$37.51
336320	Federal Signal	601518-95	REPL FLASH TUBE,601125	\$52.00	\$26.72
336320	Federal Signal	601519-95	REPL FLASH TUBE,601103	\$50.00	\$25.69
336320	Federal Signal	602111-02	CORNER STRB-A(CS1-A)	\$96.00	\$49.33
336320	Federal Signal	602111-03	CORNER STRB-B(CS1-B)	\$96.00	\$49.33
336320	Federal Signal	602111-04	CORNER STRB-R(CS1-R)	\$96.00	\$49.33

336320	Federal Signal	602111-05	CORNER STRB-C (CS1-C)	\$55.00	\$28.26
336320	Federal Signal	602121-05	CORNER STROBE,DEUTSCH-C	\$66.00	\$33.91
336320	Federal Signal	602122-05	CORNER STRB,WEATHERPACK-C	\$73.00	\$37.51
336320	Federal Signal	605010-30	DOT System Flasher, 30' TPR cable with weather tight connector	\$60.00	\$30.83
336320	Federal Signal	605010-30-D	DOT System Flasher, 30 ft TPR cable with weather tight connectors, for dual color heads	\$80.00	\$41.11
336320	Federal Signal	605010-60	DOT System Flasher, 60' TPR cable with weather tight connector	\$80.00	\$41.11
336320	Federal Signal	605010-60-D	DOT System Flasher, 60 ft TPR cable with weather tight connectors, for dual color heads	\$110.00	\$56.52
336320	Federal Signal	605015-30	4300SS Quad Mounting Box, Wires and Connectors, 30 ft cable with weather tight connector, for single color heads	\$195.00	\$100.20
336320	Federal Signal	605015-30-D	4300SS Quad Mounting Box, Wires and Connectors, 30 ft cable with weather tight connector, for dual color heads	\$205.00	\$105.34
336320	Federal Signal	620122-40	VBEAMII,40,RCSPOT,100W,PM	\$481.00	\$247.16
336320	Federal Signal	64LEDSCENE	QuadraFlare LED Scene lights, 6X4, surface mount, White LEDs, clear lens.	\$400.00	\$205.54
336320	Federal Signal	64MC	Trim Ring for 64 LEDSCENE	\$25.00	\$12.85
336320	Federal Signal	660100SSG	RS485 RELAY MODULE	\$258.00	\$132.57
336320	Federal Signal	73MC	TRIM RING FOR 73LEDSCENE	\$180.00	\$92.49
336320	Federal Signal	750501-04	AS124 Mounting bracket, no grille removal, Dodge Charger	\$50.00	\$25.69
336320	Federal Signal	750501-07	AS124 Vertical Mounting Kit	\$48.00	\$24.66
336320	Federal Signal	750501-08	ES100-AS124 Bracket Kit, Durango 15	\$48.00	\$24.66
336320	Federal Signal	750501-09	AS124 Bracket Kit, Charger 15	\$48.00	\$24.66
336320	Federal Signal	750501-10	AS124 Bracket Kit, FPIU16	\$48.00	\$24.66
336320	Federal Signal	750501-11	AS124 Bracket Kit - 2015 Tahoe	\$50.00	\$25.69
336320	Federal Signal	750501V	AS 124 Speaker, 100W, vertical mounting applications.	\$229.00	\$117.67
336320	Federal Signal	794-AH	794 Opticom infrared LED emitter, suitable for external use	\$2,150.00	\$1,104.79
336320	Federal Signal	794-HM	Opticom, LED with GPA	\$2,364.00	\$1,214.75
336320	Federal Signal	795H-EXT-D	Opticom emitter. GTT 795H emitter/bracket for attaching to driver-side of Valor, Integrity, Vision SLR, Legend and Split Vision SLR lightbars.	\$2,039.00	\$1,047.75
336320	Federal Signal	795H-EXT-P	Opticom emitter. GTT 795H emitter/bracket for attaching to passenger-side of Valor, Integrity, Vision SLR, Legend and Split Vision SLR lightbars.	\$2,039.00	\$1,047.75
336320	Federal Signal	8107230A-95	REPL FLASH TUBE,2F,401	\$46.00	\$23.64
336320	Federal Signal	8200SM6-A	31 in., 6-head, Amber	\$723.00	\$371.52
336320	Federal Signal	8200SM8A-42	42 in., 8-head, Amber	\$880.00	\$452.19
336320	Federal Signal	8200SM8A-51	51 in., 8-head, Amber	\$911.00	\$468.12
336320	Federal Signal	8200SMA10-A	31 in., 10 head Amber, (2 head arrows, 6 head stick)	\$1,259.00	\$646.94
336320	Federal Signal	8200SMA10-A-2	20 in., 10 head split, Amber, (2 head arrows, 3 head stick)	\$1,440.00	\$739.95
336320	Federal Signal	8200SMA16-A	51 in., 16 head Amber, (4 head arrows, 8 head stick)	\$1,731.00	\$889.48
336320	Federal Signal	8542D168A-0010	REPL DOME,5 PANEL-A	\$353.00	\$181.39
336320	Federal Signal	8542D168A-0011	REPL DOME,DRIVER,517102	\$353.00	\$181.39
336320	Federal Signal	8542D168A-0012	REPL DOME,PASS,	\$353.00	\$181.39
336320	Federal Signal	8542D168A-0013	REPL DOME,DRIVER,517112	\$353.00	\$181.39
336320	Federal Signal	8542D168A-0014	REPL DOME,PASS,517112	\$353.00	\$181.39
336320	Federal Signal	8620052A-95	HOUSING,RUBBER,PAR36,	\$25.00	\$12.85
336320	Federal Signal	8620140A-02-95	ISOLATD ROT ASSY,95F,TB00	\$85.00	\$43.68
336320	Federal Signal	862702266A-SHORT	Branch guard, short dome.	\$75.00	\$38.54
336320	Federal Signal	862702266A-TALL	Branch guard, tall dome.	\$85.00	\$43.68
336320	Federal Signal	90031-10	Stinger Replacement Case	\$107.00	\$97.03
336320	Federal Signal	90200-CHP	Stinger Spike System, 15.5'	\$528.00	\$478.79
336320	Federal Signal	A12SA	Voice Gun 16W, 1320-ft range, requires (8) AA batteries	\$699.00	\$359.18
336320	Federal Signal	AD26-8-M44-Z	INTERCOM,12/24VDC,REMOTE	\$1,151.00	\$591.45
336320	Federal Signal	AD-26C-1-2-4-HD	INTERCOM,12VDC,MASTER	\$1,275.00	\$655.16
336320	Federal Signal	AD26C-1-Z	INTERCOM,12/24VDC,MSTR,	\$1,166.00	\$599.15
336320	Federal Signal	AD26C-7-Z	INTERCOM,12/24DC,MASTER	\$1,243.00	\$638.72
336320	Federal Signal	AD26C-Z	INTERCOM,12/24VDC,MASTER	\$1,085.00	\$557.53
336320	Federal Signal	AD26D-1-Z	INTERCOM,12/24VDC,SLAVE,	\$1,242.00	\$638.21
336320	Federal Signal	AD26D-Z	INTERCOM,12/24VDC,SLAVE	\$1,083.00	\$556.50
336320	Federal Signal	AD26-Z	Intercom, 12/24 VDC, Basic	\$920.00	\$472.75
336320	Federal Signal	ADSF-25-Z	SPEAKER,25 WATT,FLUSH MNT	\$481.00	\$247.16
336320	Federal Signal	ADSS-25-Z	SPEAKER,25WATT,SWIVEL MNT	\$481.00	\$247.16
336320	Federal Signal	ADSV-25-Z	SPEAKER,25 WATT,W/VOLUME	\$481.00	\$247.16
336320	Federal Signal	AHRK	KIT,(1)95FPM ROT. FOR 25R	\$160.00	\$82.22
336320	Federal Signal	AHRK-F	KIT,(1)175FPM ROT. FOR 25	\$160.00	\$82.22



336320	Federal Signal	ALGT21D-AMBR3BF	Allegiant Mini Light Bar, 21", Amber/White, worklights, bed lights, low profile, flat mount, clear domes	\$845.00	\$434.21
336320	Federal Signal	ALGT21D-AMBRF	Allegiant Mini Light Bar, 21", Amber, low profile, flat mount, clear domes	\$725.00	\$372.54
336320	Federal Signal	ALGT21D-AMBRP	Allegiant Mini Light Bar, 21", Amber, low profile, permanent mount, clear domes	\$725.00	\$372.54
336320	Federal Signal	ALGT21D-FIRE1	Allegiant 21" Mini-Light Bar, Discrete model, Red warning, takedowns, Flood, Clear domes, low profile permanent mount.	\$785.00	\$403.38
336320	Federal Signal	ALGT21D-NFPA20D	Allegiant 21" Mini-Light Bar, Discrete model, driverside, Red warning, takedowns, Clear domes, low profile permanent mount.	\$720.00	\$369.97
336320	Federal Signal	ALGT21D-NFPA20P	Allegiant 21" Mini-Light Bar, Discrete model, Passenger side, Red warning, takedowns, Clear domes, low profile permanent mount.	\$720.00	\$369.97
336320	Federal Signal	ALGT21D-NFPA21	Allegiant 21" Mini-Light Bar, Discrete model, Red warning, takedowns, Clear domes, low profile permanent mount.	\$725.00	\$372.54
336320	Federal Signal	ALGT21D-NFPA22	Allegiant 21" Mini-Light Bar, Discrete model, Red warning, Clear domes, low profile permanent mount.	\$725.00	\$372.54
336320	Federal Signal	ALGT21-FIRE1	Allegiant 21" Mini-Light Bar, Serial Model, Red warning, takedowns, flood, Clear domes, low profile permanent mount, Convergence Network compatible.	\$785.00	\$403.38
336320	Federal Signal	ALGT21Z-AMBR3BP4	21 in., Serial model, Amber/White, worklights, bed lights, clear domes, 4 button controller	\$1,143.00	\$587.34
336320	Federal Signal	ALGT45D-AMBR1HC	45" Amber, takedowns, alley lights, work lights, hook mount, Clear domes.	\$2,320.00	\$1,192.14
336320	Federal Signal	ALGT45J-F2HC	45", Red/White, White LED Flood, TD, and Alley, Amber LED SignalMaster, Hook mount, Clear top dome	\$2,420.00	\$1,243.53
336320	Federal Signal	ALGT45J-F2HMC	45", Red/White, White LED Flood, TD, and Alley, Amber LED SignalMaster, Hook mount, Clear top dome, Serial Interface Module	\$2,505.00	\$1,287.20
336320	Federal Signal	ALGT45J-F2HMR	45", Red/White, White LED Flood, TD, and Alley, Amber LED SignalMaster, Hook mount, Red top dome, Serial Interface Module	\$2,505.00	\$1,287.20
336320	Federal Signal	ALGT45J-F2HR	45", Red/White, White LED Flood, TD, and Alley, Amber LED SignalMaster, Hook mount, Red top dome	\$2,420.00	\$1,243.53
336320	Federal Signal	ALGT45J-P1LC	45 in., Red/Blue, White LED Flood, White LED TD/Alley, Clear dome, Amber SignalMaster, Low Hook mount.	\$2,420.00	\$1,243.53
336320	Federal Signal	ALGT45J-P1LRB	45 in., Red/Blue, White LED Flood, White LED TD/Alley, Red/Blue dome, Amber SignalMaster, Low Hook mount.	\$2,420.00	\$1,243.53
336320	Federal Signal	ALGT45J-P2LB	45 in., Blue/Blue, White LED Flood, White LED TD/Alley, Blue dome, Amber SignalMaster, Low Hook mount.	\$2,420.00	\$1,243.53
336320	Federal Signal	ALGT45J-P2LC	45 in., Blue/Blue, White LED Flood, White LED TD/Alley, Clear dome, Amber SignalMaster, Low Hook mount.	\$2,420.00	\$1,243.53
336320	Federal Signal	ALGT45Z-AMBR3H6C	Allegiant Serial Light Bar, 45", (14) Amber/White, (4) Amber, front and rear flood, SignalMaster, hook mount, 6-button controller, clear domes.	\$2,698.00	\$1,386.38
336320	Federal Signal	ALGT53D-AMBR1FC	53" Amber, takedowns, alley lights, work lights, flat mount, Clear domes.	\$2,510.00	\$1,289.77
336320	Federal Signal	ALGT53D-AMBR1HC	Allegiant Discrete Light Bar, 53", (16) Amber, (4) Amber/White, (2) Amber/White Alley, flat mount, clear domes.	\$2,510.00	\$1,289.77
336320	Federal Signal	ALGT53D-NFPA2	53 in., Red/White, White Flood, Clear top Dome, Discrete	\$2,450.00	\$1,258.94
336320	Federal Signal	ALGT53D-TOW1FC	53 in., (16) Amber LED heads, (2) Work lights, (2) LED bed lights, (2) LED external power S/T/T lights, clear domes	\$2,510.00	\$1,289.77
336320	Federal Signal	ALGT53J-F2HC	45", Red/White, White LED Flood, TD, and Alley, Amber LED SignalMaster, Hook mount, Clear dome	\$2,650.00	\$1,361.71
336320	Federal Signal	ALGT53J-F2HMC	45", Red/White, White LED Flood, TD, and Alley, Amber LED SignalMaster, Hook mount, Clear top dome, Serial Interface Module	\$2,735.00	\$1,405.39
336320	Federal Signal	ALGT53J-F2HMRC	45", Red/White, White LED Flood, TD, and Alley, Amber LED SignalMaster, Hook mount, Red/Clear/Red top dome, Serial Interface Module	\$2,735.00	\$1,405.39
336320	Federal Signal	ALGT53J-F2HRC	45", Red/White, White LED Flood, TD, and Alley, Amber LED SignalMaster, Hook mount, Red/Clear/Red top dome	\$2,650.00	\$1,361.71
336320	Federal Signal	ALGT53J-P1LC	53 in., Red/Blue, White LED Flood, White LED TD/Alley, Clear dome, Amber SignalMaster, Low Hook mount.	\$2,650.00	\$1,361.71
336320	Federal Signal	ALGT53J-P2LC	53 in., Blue/Blue, White LED Flood, White LED TD/Alley, Clear dome, Amber SignalMaster, Low Hook mount.	\$2,650.00	\$1,361.71
336320	Federal Signal	ALGT53Z--AMBR3BF6C	Allegiant Serial Light Bar, 53", (16) Amber/White, (4) Amber, front and rear flood, SignalMaster, flat mount, 6-button controller, clear domes.	\$2,928.00	\$1,504.56
336320	Federal Signal	ALGT53Z-AMBR3F6C	53" Amber, front and rear flood, SignalMaster, flat, 6-button controller, Clear domes.	\$2,928.00	\$1,504.56
336320	Federal Signal	ALGT53Z-AMBR3H6C	53" Amber, front and rear flood, SignalMaster, hook, 6-button controller, Clear domes.	\$2,928.00	\$1,504.56

336320	Federal Signal	ALGT53ZS-AMBR3H6C-F	Allegiant Light Bar, 53", Special, Stock Bar	\$2,928.00	\$1,504.56
336320	Federal Signal	ALGT61D-NFPA1	61 in., Red/White, Red top Dome, Discrete	\$2,710.00	\$1,392.54
336320	Federal Signal	ALGT61D-NFPA2	61 in., Red/White, White Flood, Clear top Dome, Discrete	\$2,610.00	\$1,341.16
336320	Federal Signal	ALGT61DS-TOW2FCW	Allegiant Light Bar, 61", Special, Stock Bar	\$2,660.00	\$1,366.85
336320	Federal Signal	ALGT61D-TOW2FC	Allegiant Serial Light Bar, 61", (22) Amber, (2) LED bed lights, (2) LED S/T/T lights, SignalMaster, flat mount, 6-button controller, clear domes.	\$2,660.00	\$1,366.85
336320	Federal Signal	ALGT61D-TOWSFC	61 in., (22) Amber LED heads, (4) Work lights, (2) LED bed lights, (2) LED external power S/T/T lights, clear domes, rear flood.	\$2,780.00	\$1,428.51
336320	Federal Signal	ALGT61Z-TOW2F6C	61 in., (22) Amber LED heads, (2) Work lights, (2) LED bed lights, (2) LED external power S/T/T lights, SignalMaster, 6 button controller, clear domes	\$2,958.00	\$1,519.98
336320	Federal Signal	ALGT70D-AMBR5FC	Allegiant Discrete Light Bar, 70", (28) Amber, (2) led S/T/T flat mount, clear domes.	\$2,800.00	\$1,438.79
336320	Federal Signal	ALGT70D-NFPA2	70 in., Red/White, White Flood, Clear top Dome, Discrete	\$2,780.00	\$1,428.51
336320	Federal Signal	ALGT70Z-AMBR5F6C	Allegiant Serial Light Bar, 70", (28) Amber, (2) LED S/T/T lights, SignalMaster, flat mount, 6-button controller, clear domes.	\$3,098.00	\$1,591.92
336320	Federal Signal	ALGT80D-AMBR5FC	80 in., (34) Amber LED heads, (4) LED bed lights, Clear domes.	\$3,040.00	\$1,562.12
336320	Federal Signal	ALGT80D-AMBR5FC	80 in., (34) Amber LED heads, (8) LED work lights, Clear domes.	\$3,080.00	\$1,582.67
336320	Federal Signal	BP100	BP Series speaker 100W, Black	\$595.00	\$305.74
336320	Federal Signal	BP200-EF	BP Series 200W, stainless steel "Electric F" grille, recess mount	\$759.00	\$390.02
336320	Federal Signal	BP200-LL	200 Watt speaker, W/EF-LL Grille	\$759.00	\$390.02
336320	Federal Signal	BP200-Q	BP Series 200W, Chrome Q-Siren grille, recess mount	\$1,035.00	\$531.84
336320	Federal Signal	BPFMT-EF	Speaker Bracket-Grille assembly, BP100	\$78.00	\$40.08
336320	Federal Signal	BPMT	BP Series bumper mount	\$68.00	\$34.94
336320	Federal Signal	CNSM2X4R-3452898	Split 8-Head CN SignalMaster Rear Models, without interface module - (2) Red/Blue LED reflectors, (6) Amber LED reflectors, 6-head SignalMaster	\$890.00	\$457.33
336320	Federal Signal	CNSM2X4R-3460910	Split 8-Head CN SignalMaster Rear Models, without interface module - (4) Red/Amber LED reflectors, (4) Blue/Amber LED reflectors, 8-head SignalMaster	\$1,160.00	\$596.07
336320	Federal Signal	CNSM2X4R-3467970	Split 8-Head CN SignalMaster Rear Models, without interface module - (8) Red/Blue/Amber LED reflectors, 8-head SignalMaster	\$1,360.00	\$698.84
336320	Federal Signal	CNSM2X4R-3467973	Split 8-Head CN SignalMaster Rear Models, with interface module - (8) Red/Blue/Amber LED reflectors, 8-head SignalMaster	\$1,430.00	\$734.81
336320	Federal Signal	CNSM2X4R-3467975	Split 8-Head CN SignalMaster Rear Models, with interface module - (2) Red/Blue LED reflectors, (6) Amber LED reflectors, 6-head SignalMaster	\$960.00	\$493.30
336320	Federal Signal	CNSM2X4R-3467990	Split 8-Head CN SignalMaster Rear Models, with interface module - (4) Red/Amber LED reflectors, (4) Blue/Amber LED reflectors, 8-head SignalMaster	\$1,230.00	\$632.04
336320	Federal Signal	CNSM2X4R-3493515	CN SignalMaster, Split 8-head SignalMaster, 8 Amber LED reflectors, No interface module, 25' cable	\$800.00	\$411.08
336320	Federal Signal	CNSM2X4R-3493521	CN SignalMaster, Split 8-Head Rear Models, with interface module. (8) Amber LED reflectors	\$870.00	\$447.05
336320	Federal Signal	CNSM2X4R-3590662	CN SignalMaster, Split 8-Head Rear Models, without interface module. (8) Amber/Red LED reflectors	\$1,160.00	\$596.07
336320	Federal Signal	CNSM2X4R-3603252	CN SignalMaster, Split 8-Head Rear Models, with interface module. (8) Amber/Red LED reflectors	\$1,230.00	\$632.04
336320	Federal Signal	CNSM2X4R-3603262	CN SignalMaster, Split 8-Head Rear Models, with interface module. (6) Amber and (2) Red LED reflectors	\$870.00	\$447.05
336320	Federal Signal	CNSM2X4R-3642343	CN SignalMaster, Split 8-head SignalMaster, 8 Amber LED reflectors, 6 button controller, 25' cable	\$1,168.00	\$600.18
336320	Federal Signal	CNSM2X4R-AMBR4	CN SignalMaster, Split 8-head SignalMaster, 8 Amber/White LED reflectors, No interface module, 25' cable	\$1,160.00	\$596.07
336320	Federal Signal	CNSM2X4RS-AMBR5	CN SignalMaster, Split 8-head SignalMaster, 8 Amber/White LED reflectors, Interface module, 25' cable	\$1,230.00	\$632.04
336320	Federal Signal	CNSM2X4RS-AMBR7	CN SignalMaster, Split 8-head SignalMaster, 8 Amber/White LED reflectors, 6 button controller, 25' cable	\$1,528.00	\$785.17
336320	Federal Signal	CNSM4F-2647802	CN SignalMaster, (2) Red/White LED reflectors, (2) Blue/White LED reflectors, with flood capability. With Interface module	\$700.00	\$359.70
336320	Federal Signal	CNSM4F-2649434	CN SignalMaster, (2) Red/White LED reflectors, (2) Blue/White LED reflectors, with flood capability.	\$630.00	\$323.73
336320	Federal Signal	CNSM4F-2649442	CN SignalMaster, (1) Red LED reflectors, (1) Red/White LED reflectors, (1) Blue/White LED reflector, (1) Blue reflector, with takedown capability. With Interface module.	\$610.00	\$313.45

336320	Federal Signal	CNSM4F-2649491	CN SignalMaster, (1) Red LED reflectors, (1) Red/White LED reflectors, (1) Blue/White LED reflector, (1) Blue reflector, with takedown capability.	\$540.00	\$277.48
336320	Federal Signal	CNSM4F-2649504	CN SignalMaster, (2) Red LED reflectors, (2) Blue LED reflectors, alternating.. With Interface module.	\$520.00	\$267.20
336320	Federal Signal	CNSM4F-2649516	CN SignalMaster, (2) Red LED reflectors, (2) Blue LED reflectors, alternating.	\$450.00	\$231.23
336320	Federal Signal	CNSM4R-2649764	CN SignalMaster, Rear model with Interface module. (2) Red, (2) Blue, alternating	\$520.00	\$267.20
336320	Federal Signal	CNSM4R-2651544	CN SignalMaster, Rear model without Interface module. (2) Red, (2) Blue, alternating	\$450.00	\$231.23
336320	Federal Signal	CNSM4R-2651620	CN SignalMaster, Rear model without Interface module. (2) Red/Amber, (2) Blue/Amber.	\$630.00	\$323.73
336320	Federal Signal	CNSM4R-2651628	CN SignalMaster, Rear model with Interface module. (2) Red/Amber, (2) Blue/Amber.	\$700.00	\$359.70
336320	Federal Signal	CNSM4R-2657756	CN SignalMaster, 4-Head Rear Models, without interface module. (4) Amber LED reflectors	\$450.00	\$231.23
336320	Federal Signal	CNSM4R-2657767	CN SignalMaster, 4-Head Rear Models, without interface module. (4) Amber/Red LED reflectors	\$630.00	\$323.73
336320	Federal Signal	CNSM4R-3433609	CN SignalMaster, 4-Head Rear Models, with interface module. (4) Amber/Red LED reflectors	\$700.00	\$359.70
336320	Federal Signal	CNSM4R-3433618	CN SignalMaster, 4-Head Rear Models, with interface module. (4) Amber LED reflectors	\$520.00	\$267.20
336320	Federal Signal	CNSM4R-CAT1	CN SignalMaster, Rear model with Interface module. (1) Red, (1) Red/White, (1) Blue/White, (1) Blue..	\$610.00	\$313.45
336320	Federal Signal	CNSM4R-CAT2	CN SignalMaster, Rear model without Interface module. (1) Red, (1) Red/White, (1) Blue/White, (1) Blue..	\$540.00	\$277.48
336320	Federal Signal	CNSM4R-CAT3	CN SignalMaster, Rear model with Interface module. (2) Red/White, (2) Blue/White.	\$700.00	\$359.70
336320	Federal Signal	CNSM4R-CAT4	CN SignalMaster, Rear model without Interface module. (2) Red/White, (2) Blue/White.	\$630.00	\$323.73
336320	Federal Signal	CNSM8F-2651981	CN SignalMaster, 8 head Front model with interface module. (4) Red/White, (4) Blue/White	\$1,230.00	\$632.04
336320	Federal Signal	CNSM8F-2652911	CN SignalMaster, 8 head Front model without interface module. (4) Red/White, (4) Blue/White	\$1,160.00	\$596.07
336320	Federal Signal	CNSM8F-2653199	CN SignalMaster, 8 head Front model with interface module. (3) Red, (1) Red/White, (3) Blue, (1) Blue/White.	\$960.00	\$493.30
336320	Federal Signal	CNSM8F-2653827	CN SignalMaster, 8 head Front model without interface module. (3) Red, (1) Red/White, (3) Blue, (1) Blue/White.	\$890.00	\$457.33
336320	Federal Signal	CNSM8F-2653866	CN SignalMaster, 8 head Front model with interface module. (4) Red, (4) Blue.	\$870.00	\$447.05
336320	Federal Signal	CNSM8F-2653949	CN SignalMaster, 8 head Front model without interface module. (4) Red, (4) Blue.	\$800.00	\$411.08
336320	Federal Signal	CNSM8R-2654018	8 HEAD MODEL, 8 AMBER LED REFLECTORS, NO INTERFACE MODULE	\$870.00	\$447.05
336320	Federal Signal	CNSM8R-2654044	CN SignalMaster, 8 head Rear model without interface module. (8) Amber.	\$800.00	\$411.08
336320	Federal Signal	CNSM8R-2654681	CN SignalMaster, 8-head Rear Model with interface module, (4) Red/Amber, (4) Blue/Amber.	\$1,230.00	\$632.04
336320	Federal Signal	CNSM8R-2654695	CN SignalMaster, 8 head Rear model without interface module. (4) Red/Amber, (4) Blue/Amber.	\$1,160.00	\$596.07
336320	Federal Signal	CNSM8R-26546955	SignalMaster, Stock Bar	\$1,160.00	\$596.07
336320	Federal Signal	CNSM8R-2654695S	CN SignalMaster, 8-head rear model, without interface module, 31.2", (4) Red/Amber, (4)Blue/Amber LED reflectors	\$1,160.00	\$596.07
336320	Federal Signal	CNSM8R-2654732	CN SignalMaster, 8-head Rear Model with interface module, (4) Red, (4) Blue.	\$870.00	\$447.05
336320	Federal Signal	CNSM8R-2654797	CN SignalMaster, 8 head Rear model without interface module. (4) Red, (4) Blue.	\$800.00	\$411.08
336320	Federal Signal	CNSM8R-2657764	CN SignalMaster, 8-Head Rear Models, without interface module. (8) Amber/Red LED reflectors	\$1,160.00	\$596.07
336320	Federal Signal	CNSM8R-3433621	CN SignalMaster, 8-Head Rear Models, with interface module. (8) Amber LED reflectors	\$870.00	\$447.05
336320	Federal Signal	CNSM8R-3433627	CN SignalMaster, 8-Head Rear Models, with interface module. (8) Amber/Red LED reflectors	\$1,230.00	\$632.04
336320	Federal Signal	CNSM8R-4035317	CN SignalMaster, 8-head rear model, without interface module, 31.2", (8) Blue/Amber LED reflectors	\$1,160.00	\$596.07
336320	Federal Signal	CNSM8RS-AMBR4	CN SignalMaster, 8 head Rear model without interface module. (8) Amber.	\$1,160.00	\$596.07
336320	Federal Signal	CNSM8RS-AMBR5	8 HEAD MODEL, 8 AMBER/WHITE LED REFLECTORS, INTERFACE MODULE	\$1,230.00	\$632.04
336320	Federal Signal	CNSM8RS-AMBR7	8 HEAD MODEL, 8 AMBER/SHITE LED REFLECTORS, 6 BUTTON CONTROLLER	\$1,528.00	\$785.17

336320	Federal Signal	CNSM8RS-RAB	CN SignalMaster, 8-head Rear Model with interface module, (1) Red, (6) Amber, (1) Blue.	\$870.00	\$447.05
336320	Federal Signal	CNSM8RS-RAB2	CN SignalMaster, 8-head Rear Model without interface module, (1) Red, (6) Amber, (1) Blue.	\$800.00	\$411.08
336320	Federal Signal	CNSM-FRD18ND	No drill mount kit for installing CN SignalMaster in F150 grille, 2018	\$54.00	\$27.75
336320	Federal Signal	CNSMO-SIM	Serial interface module	\$120.00	\$61.66
336320	Federal Signal	CNSM-RBK1	Mount kit for installing eight-head CN SignalMaster in 2013 Police Utility	\$54.00	\$27.75
336320	Federal Signal	CNSM-TAH21	Grille Bracket	\$54.00	\$27.75
336320	Federal Signal	CNSM-UM	UNIVERSAL MOUNT KIT FOR INTERNAL AND EXTERNAL USE	\$54.00	\$27.75
336320	Federal Signal	CNTRLR-4B	Four-button programmable serial controller	\$180.00	\$92.49
336320	Federal Signal	CNTRLR-6B	Six-button programmable serial controller	\$298.00	\$153.13
336320	Federal Signal	CNTRLR-9B	Nine-button programmable serial controller	\$298.00	\$153.13
336320	Federal Signal	COM120	Commander, 20K Lumen, 120 VAC	\$2,427.00	\$1,247.12
336320	Federal Signal	COM1200-RND	LED Worklight, Round, Flood	\$116.00	\$59.61
336320	Federal Signal	COM1200-SQ	LED Worklight, Square, Flood	\$116.00	\$59.61
336320	Federal Signal	COM120-260	Commander Series Surface Mount Lights, chrome bezel, 15K lumen, 120 VAC	\$2,427.00	\$1,247.12
336320	Federal Signal	COM120-510	Commander , 120 VAC, 510 mount	\$2,715.00	\$1,395.11
336320	Federal Signal	COM120-510-P1	Commander, 20K Lumen, 120 VAC	\$2,619.00	\$1,345.78
336320	Federal Signal	COM120-530-NH	Commander, 20K Lumen, 120 VAC	\$2,715.00	\$1,395.11
336320	Federal Signal	COM120-570	Commander, 20K Lumen, 120 VAC	\$2,802.00	\$1,439.82
336320	Federal Signal	COM120-800-18	Commander, 20K Lumen, 120 VAC	\$2,561.00	\$1,315.98
336320	Federal Signal	COM120-850	Commander, 20K Lumen, 120 VAC	\$2,324.00	\$1,194.20
336320	Federal Signal	COM120-ON	Commander, 20K Lumen, 120 VAC, on/off	\$2,292.00	\$1,177.75
336320	Federal Signal	COM120-ON-530	Commander, 20K Lumen, ON/OFF SWITCH	\$3,082.00	\$1,583.70
336320	Federal Signal	COM120-ON-530SW	Commander, 20K Lumen, 120 VAC ON/OFFSIDE MNT	\$3,206.00	\$1,647.42
336320	Federal Signal	COM120-ON-540SW	Commander, 20K Lumen, 120 VAC ON/OFFSIDE	\$3,159.00	\$1,623.26
336320	Federal Signal	COM120-ON-600-603	Commander, 20K Lumen, 120 VAC, on/off SW	\$3,598.00	\$1,848.85
336320	Federal Signal	COM120-ON-642-603	Commander, 20K Lumen, 120 VAC	\$3,427.00	\$1,760.98
336320	Federal Signal	COM120-ON-656-603-P1	Commander, 20K Lumen, 120 VAC, Tripod, on/off	\$3,463.00	\$1,779.48
336320	Federal Signal	COM120-ON-700	Commander, 20K Lumen, 120 VAC ON/OFF	\$2,419.00	\$1,243.01
336320	Federal Signal	COM120-ON-700P1	Commander, 20K Lumen, 120 V	\$2,931.00	\$1,506.11
336320	Federal Signal	COM145LC-W	Commander Compartment Lights, 3" Round, Dual Color, Clear lens, surface mount, 6 LED light head, 3 Red, 3 White.	\$44.00	\$22.61
336320	Federal Signal	COM15-K	Commander, 15K Lumen, 12/24 VDC, LED	\$2,045.00	\$1,050.83
336320	Federal Signal	COM15K-260	Commander Series Surface Mount Lights, chrome bezel, 15L lumen, 12/24 VDC	\$1,946.00	\$999.96
336320	Federal Signal	COM15K-530	Commander, 15K Lumen, 12/24 V	\$2,605.00	\$1,338.59
336320	Federal Signal	COM15K-530SW	Commander, 15K Lumen, Bottom Raise	\$2,729.00	\$1,402.31
336320	Federal Signal	COM15K-530SW-B	Commander, 15K Lumen, Bottom Raise	\$2,834.00	\$1,456.26
336320	Federal Signal	COM15K-540	Commander, 15K Lumen, 12/24 V , Side	\$2,605.00	\$1,338.59
336320	Federal Signal	COM15K-540SW	Commander, 15K Lumen, 12/24 V , Side	\$2,683.00	\$1,378.67
336320	Federal Signal	COM15K-570	Commander, 15K Lumen, 12/24 VDC,	\$2,201.00	\$1,130.99
336320	Federal Signal	COM15K-800-03	Commander, DC 15K Lumen, 12/24 VDC	\$2,306.00	\$1,184.95
336320	Federal Signal	COM15K-800-05	Commander, 15K Lumen, 12/24 V	\$2,306.00	\$1,184.95
336320	Federal Signal	COM15K-800-07	Commander, 15K Lumen, 12/24 VDC	\$2,096.00	\$1,077.04
336320	Federal Signal	COM15K-800-08	Commander, 15K Lumen, Contour Brow Mount	\$2,306.00	\$1,184.95
336320	Federal Signal	COM15K800-10	Commander, DC 15K Lumen, 12/24 VDC	\$2,306.00	\$1,184.95
336320	Federal Signal	COM15K-830	Commander, 15K Lumen, 12/24 VDC,	\$2,248.00	\$1,155.14
336320	Federal Signal	COM15K-850	Commander, 15K Lumen, 12/24 DC	\$2,175.00	\$1,117.63
336320	Federal Signal	COM1FC-A	Commander 1" Flashing light, Single Color, Clear lens, surface mount, Chrome flange, 4-LED light head, Amber	\$29.00	\$14.90
336320	Federal Signal	COM1FC-B	Commander 1" Flashing light, Single Color, Clear lens, surface mount, Chrome flange, 4-LED light head, Blue	\$35.00	\$17.98
336320	Federal Signal	COM1FC-R	Commander 1" Flashing light, Single Color, Clear lens, surface mount, Chrome flange, 4-LED light head, Red	\$29.00	\$14.90
336320	Federal Signal	COM1FC-W	Commander 1" Flashing light, Single Color, Clear lens, surface mount, Chrome flange, 4-LED light head, White	\$35.00	\$17.98
336320	Federal Signal	COM1LC-W	Commander Compartment Lights, 3" Round, Dual Color, Clear lens, surface mount, 6 LED light head, 3 Blue, 3 White	\$40.00	\$20.55
336320	Federal Signal	COM1MC-A	Commander 1" Marker light, Single Color, Clear lens, surface mount, Chrome flange, 4-LED light head, Amber	\$29.00	\$14.90
336320	Federal Signal	COM1MC-G	Commander 1" Marker light, Single Color, Clear lens, surface mount, Chrome flange, 4-LED light head, Green	\$35.00	\$17.98
336320	Federal Signal	COM1MC-R	Commander 1" Marker light, Single Color, Clear lens, surface mount, Chrome flange, 4-LED light head, Red	\$29.00	\$14.90

336320	Federal Signal	COM20K	Commander, 20K Lumen, 12/24 VDC, LED	\$2,427.00	\$1,247.12
336320	Federal Signal	COM20K-11-BOB	Commander, 20K Lumen, 12/24 V, LED	\$2,653.00	\$1,363.25
336320	Federal Signal	COM20K-510	Commander, 20K Lumens, 12/24 VDC, 510 Pole	\$3,407.00	\$1,750.70
336320	Federal Signal	COM20K-530SW	Commander, 20K Lumen, 12/24 V, Sidemount Bottom	\$3,111.00	\$1,598.60
336320	Federal Signal	COM20K-530SW-BOB	Commander, 20K Lumens, 12V	\$3,568.00	\$1,833.43
336320	Federal Signal	COM20K-530SW-BOB-ON	Commander, 20K Lumens, 12/24 VDC	\$3,107.00	\$1,596.54
336320	Federal Signal	COM20K-800-05	Commander, 20K Lumen, 12/24 VDC, Coutour	\$2,561.00	\$1,315.98
336320	Federal Signal	COM20K-800-10	Commander, 20K Lumen, 12/24 VDC, Coutour	\$2,444.00	\$1,255.86
336320	Federal Signal	COM20K-800-11-BOB	Commander, 20K Lumens, 12/24 V LED	\$2,786.00	\$1,431.60
336320	Federal Signal	COM20K-830	Commander, 20K Lumen, 12/24 VDC	\$2,629.00	\$1,350.92
336320	Federal Signal	COM20K-850	Commander, 20K Lumen	\$2,324.00	\$1,194.20
336320	Federal Signal	COM20K-ON	Commander, 20K Lumen, 12/24 VDC, ON/OFF SWT	\$2,521.00	\$1,295.43
336320	Federal Signal	COM20K-ON-530SW	Commander, 20K Lumen, 12/24 V, ON/OFF SWT	\$3,206.00	\$1,647.42
336320	Federal Signal	COM20K-ON-530SW-BOB	Commander, 20K Lumen, 12/24 VDC	\$2,983.00	\$1,532.83
336320	Federal Signal	COM20K-ON-540TW	Commander, 20K Lumen, ON/OFF SWITCH	\$2,935.00	\$1,508.16
336320	Federal Signal	COM240	Commander, 20K Lumens, 240 VAC	\$2,206.00	\$1,133.56
336320	Federal Signal	COM240-510-CL-ON	Commander, 20K Lumens, 240VAC, TWSTLK	\$3,460.00	\$1,777.93
336320	Federal Signal	COM240-540-CL-ON-A	Commander, 20K Lumens, 240VAC, TWSTLK, SM, O/S B	\$3,460.00	\$1,777.93
336320	Federal Signal	COM240-570	Commander, 20K Lumen, 240 VAC	\$2,547.00	\$1,308.79
336320	Federal Signal	COM240-570-ON	Commander, 20K Lumens, 240VAC, FIXED TM	\$2,928.00	\$1,504.56
336320	Federal Signal	COM240-ON-510-TW-CL-BOB	Commander, 20K Lumens, 240VAC, ON/OFF	\$3,624.00	\$1,862.21
336320	Federal Signal	COM3FAA	Commander 3" Flashing Lights - Single color, 6-LED, Amber LED, Amber Lens.	\$70.00	\$35.97
336320	Federal Signal	COM3FAC	Commander 3" Flashing Lights - Single color, 6-LED, Amber LED, Clear Lens.	\$70.00	\$35.97
336320	Federal Signal	COM3FBB	Commander 3" Flashing Lights - Single color, 6-LED, Blue LED, Blue Lens.	\$70.00	\$35.97
336320	Federal Signal	COM3FBC	Commander 3" Flashing Lights - Single color, 6-LED, Blue LED, Clear Lens.	\$70.00	\$35.97
336320	Federal Signal	COM3FRC	Commander 3" Flashing Lights - Single color, 6-LED, Red LED, Clear Lens.	\$70.00	\$35.97
336320	Federal Signal	COM3FRR	Commander 3" Flashing Lights - Single color, 6-LED, Red LED, Red Lens.	\$70.00	\$35.97
336320	Federal Signal	COM3SBWC	Commander 3" Two Color Compartment Lights - separate control of colors, 3 Blue/3 White LED, Clear Lens	\$78.00	\$40.08
336320	Federal Signal	COM3SRR	Commander 3" Compartment Lights - Single color, 6-LED, Red LED, Red Lens.	\$70.00	\$35.97
336320	Federal Signal	COM3SRWC	Commander 3" Two Color Compartment Lights - separate control of colors, 3 Red/3 white LED, Clear Lens	\$78.00	\$40.08
336320	Federal Signal	COM3SWC	Commander 3" Compartment Lights - Single color, 6-LED, White LED, Clear Lens.	\$70.00	\$35.97
336320	Federal Signal	COM7K-900	Commander Series Surface Mount Lights, chrome bezel, 7K Lumen, 12/24 VDC	\$735.00	\$377.68
336320	Federal Signal	COM8PTC	Commander 8" Round LED Interior Lights - 18 White LED, White Lens, Chrome Flange	\$151.00	\$77.59
336320	Federal Signal	COMFF100	Commander Series Flex Lights, Firefly, 650 lumen, 12/24 VDC, surface mount, focused lens.	\$206.00	\$105.85
336320	Federal Signal	COMFF110	Commander Series Flex Lights, Firefly, 650 lumen, 12/24 VDC, surface mount, flood lens.	\$206.00	\$105.85
336320	Federal Signal	COMINT5-W	Commander 5" LED Interior Light, White, Clear lens	\$30.00	\$15.42
336320	Federal Signal	COMLC11K	COM LC, 11K LUMEN, 12/24V,	\$1,569.00	\$806.24
336320	Federal Signal	COMLC11K-530-H	COM LC, 11K LUMEN, 12/24V, SPT/FL	\$2,184.00	\$1,122.26
336320	Federal Signal	COMLC11K-540-H	COM LC, 11K LUMENS, 12/24VDC,	\$2,184.00	\$1,122.26
336320	Federal Signal	COMLC11K-540-TW	COM LC, 11K LUMEN, 12/24VDC.	\$1,891.00	\$971.70
336320	Federal Signal	COMLC11K-540TWSW	COM LC, 11K LUM, 12/24V, SIDE MNT	\$2,057.00	\$1,057.00
336320	Federal Signal	COMLC11K-570	COM LC, 11K LUMEN, 12/24V, SPT/FL	\$1,981.00	\$1,017.94
336320	Federal Signal	COMLC11K-570-ON	COM LC, 11K LUMENS, 12/24 VDC,	\$2,075.00	\$1,066.25
336320	Federal Signal	COMLC11K-850	COM LC, 11K LUMEN, 12/24V, SPT/FL	\$1,709.00	\$878.18
336320	Federal Signal	COMLC15K-210	COM LC, 15K LUMEN, 12/24VDC	\$1,883.00	\$967.59
336320	Federal Signal	COMLC15K-530-ST-TW-A-PORT	COM LC, BTM RAISE POLE W/10" OT	\$2,141.00	\$1,100.16
336320	Federal Signal	COMLC15K-576-PORT	COM LC, 15K LUMEN, 12/24V, PUSH	\$1,968.00	\$1,011.26
336320	Federal Signal	COMLC20K	COM LC, 20K LUMEN, 12/24VDC LED	\$1,898.00	\$975.29
336320	Federal Signal	COMLC20K-510-BLA	LC, 20K LUM, 12/24V, TOP MOUNT	\$2,355.00	\$1,210.13
336320	Federal Signal	COMLC20K-530-ST-TW	COM LC, 20K LUM, 12/24V, BTM RSE	\$2,285.00	\$1,174.16
336320	Federal Signal	COMLC20K-530SW-H	COM LC, 20K LUM, 12/24V, SIDE MNT	\$2,638.00	\$1,355.55
336320	Federal Signal	COMLC20K-540TW-H	COM LC, 20K LUM, 12/24V, SIDE	\$2,394.00	\$1,230.17
336320	Federal Signal	COMLC20K-570	COM LC, 20K LUMEN, 12/24VDC, LED	\$2,311.00	\$1,187.52
336320	Federal Signal	COMLC20K-800-08	COM LC, 20K LUM, 12/24V, CONTOUR	\$2,186.00	\$1,123.28
336320	Federal Signal	COMLC20K-800-09	COM LC, 20K LUM, 12/24V, BROW	\$2,001.00	\$1,028.22

336320	Federal Signal	COMLC8K-576-PORT	COM LC,8K LUMEN,12/24V,PUSH	\$1,686.00	\$866.36
336320	Federal Signal	COMLS15K-530SW-NH	COMMANDER LS,15K,12VDC,PUSHUP	\$2,398.00	\$1,232.22
336320	Federal Signal	COMLS15K-800-03-09-SP	COMMANDER LS, 15K, 12VDC,	\$1,988.00	\$1,021.54
336320	Federal Signal	COMLS15K-800-03-11	COMMANDER LS, 15K, 12/24VDC,	\$1,988.00	\$1,021.54
336320	Federal Signal	COMLS15K-830	COMMANDER LS, 15K, 12/24VDC,	\$1,928.00	\$990.71
336320	Federal Signal	COMLS15K-NH	COMMANDER LS, 15K, 12/24VDC,	\$1,726.00	\$886.91
336320	Federal Signal	COMMS-120	COM M,14K LUM,120VAC FLOOD LED	\$1,877.00	\$964.50
336320	Federal Signal	COMMS-120-570	COM M,14K LUM,120VAC FLOOD LED	\$2,253.00	\$1,157.71
336320	Federal Signal	COMMS-120-ON-530	COM M,14K LUM,120VAC,SIDE MNT	\$2,531.00	\$1,300.56
336320	Federal Signal	COMMS-120-ON-540-H	COM M,14K LUM,120VAC,SIDE MNT	\$2,502.00	\$1,285.66
336320	Federal Signal	COMMS-120-ON-700	COM M, 14K LUM, 120VAC ON/OFF,	\$2,040.00	\$1,048.26
336320	Federal Signal	COMMS-240	COM M,14K LUM,240VAC FLOOD LED	\$1,706.00	\$876.63
336320	Federal Signal	COMMS-240-570	COM M,14K LUM,240VAC FLOOD LED	\$2,049.00	\$1,052.89
336320	Federal Signal	COMMS-240-ON-530	COM M,14K LUM,240VAC,SIDE MNT	\$2,301.00	\$1,182.38
336320	Federal Signal	COMMS-DC	COM M,14K LUM,12/24VDC FLOOD L	\$1,658.00	\$851.97
336320	Federal Signal	COMMS-DC-570	COM M,14K LUM,12/24VDC,FLOOD	\$2,033.00	\$1,044.66
336320	Federal Signal	COMMS-DC-850-BOB	COMM, 14K LUM, 12/24VDC, FLAT	\$1,692.00	\$869.44
336320	Federal Signal	COMMS-DC-ON-530	COM M,14K LUM,12/24VDC,SIDE MT	\$2,310.00	\$1,187.00
336320	Federal Signal	COMMS-DC-SB500	COM M,14K LUM,12/24VDC,	\$1,977.00	\$1,015.89
336320	Federal Signal	COMSB-FLD-CD	LED SCN,FLOOD,DC,7LUM,CD BASE	\$846.00	\$434.72
336320	Federal Signal	COMSB-FLD-CD-BLA	LED SCN,FLOOD,DC,7LUM,CD BASE	\$770.00	\$395.67
336320	Federal Signal	COMSB-FLD-NM	LED SCN,FLOOD,DC,7LUM,NO MNT,	\$706.00	\$362.78
336320	Federal Signal	COMSB-FLD-YM	LED SCN,FLOOD,DC,7LUM,YOKE MNT	\$735.00	\$377.68
336320	Federal Signal	COMSB-FLD-YM-BLA	LED SCN,FLOOD,DC,7LUM,YOKE MNT	\$668.00	\$343.25
336320	Federal Signal	COMSB-SPT-CD	LED SCN,SPOT,DC,7LUM,CD BASE	\$846.00	\$434.72
336320	Federal Signal	COMSB-SPT-NM	LED SCN,SPOT,DC,7LUM,NO MNT,	\$706.00	\$362.78
336320	Federal Signal	COMSB-SPT-YM	LED SCN,SPOT,DC,7LUM,YOKE	\$735.00	\$377.68
336320	Federal Signal	COMSB-TRP-CD	LED SCN,TRAPZ,DC,7LUM,CD BASE	\$846.00	\$434.72
336320	Federal Signal	COMSB-TRP-CD-BLA	LED SCN,TRAPZ,DC,7LUM,CD BASE	\$770.00	\$395.67
336320	Federal Signal	COMSB-TRP-NM	LED SCN,TRAPZ,DC,7LUM,NO MNT,	\$706.00	\$362.78
336320	Federal Signal	COMSB-TRP-YM	LED SCN,TRAPZ,DC,7LUM,YOKE MNT	\$735.00	\$377.68
336320	Federal Signal	COMSB-TRP-YM-BLA	LED SCN,TRAPZ,DC,7LUM,YOKE MNT	\$668.00	\$343.25
336320	Federal Signal	COMSTL-BTT	Commander 10" LED Strip Light Series, Brake/Tail/Turn model, Red LEDs, Red lens.	\$123.00	\$63.20
336320	Federal Signal	COMSTLF-A	Commander 10" LED Strip Light Series, Warning light model, Amber LEDs, Amber lens	\$118.00	\$60.63
336320	Federal Signal	COMSTLF-B	Commander 10" LED Strip Light Series, Warning light model, Blue LEDs, Blue lens.	\$118.00	\$60.63
336320	Federal Signal	COMSTLFC-A	Commander 10" LED Strip Light Series, Warning light model, Amber LEDs, Clear lens.	\$118.00	\$60.63
336320	Federal Signal	COMSTLFC-B	Commander 10" LED Strip Light Series, Warning light model, Blue LEDs, Blue lens.	\$118.00	\$60.63
336320	Federal Signal	COMSTLFC-R	Commander 10" LED Strip Light Series, Warning light model, Red LEDs, Clear lens.	\$118.00	\$60.63
336320	Federal Signal	COMSTLF-R	Commander 10" LED Strip Light Series, Warning light model, Red LEDs, Red lens.	\$118.00	\$60.63
336320	Federal Signal	COMSTLS18C-W	Commander 10" LED Strip Light Series, Compartment Light model, (18) White LEDs, Frosted lens.	\$118.00	\$60.63
336320	Federal Signal	COMSTLS6C-W	Commander 10" LED Strip Light Series, Compartment Light model, (6) White LEDs, Frosted lens.	\$75.00	\$38.54
336320	Federal Signal	COMSTL-TANK	Commander 10" LED Strip Light Series, Tank light model, Amber, Blue, Green, Red LEDs, clear lens.	\$197.00	\$101.23
336320	Federal Signal	COMSTR-18	COMPARTMENT LIGHT STRIP LED 18	\$159.00	\$81.70
336320	Federal Signal	COMSTR-27	COMPARTMENT LIGHT STRIP LED 27	\$176.00	\$90.44
336320	Federal Signal	COMSTR-36	COMPARTMENT LIGHT STRIP LED 36	\$204.00	\$104.83
336320	Federal Signal	COMSTR-45	COMPARTMENT LIGHT STRIP LED 45	\$255.00	\$131.03
336320	Federal Signal	COMSTR-54	COMPARTMENT LIGHT STRIP LED 54	\$296.00	\$152.10
336320	Federal Signal	COMSTR-63	COMPARTMENT LIGHT STRIP LED 63	\$345.00	\$177.28
336320	Federal Signal	COMSTR-9	COMPARTMENT LIGHT STRIP LED 9	\$92.00	\$47.27
336320	Federal Signal	COMX-120	COM PLUS,28K LUM,120VAC	\$2,672.00	\$1,373.02
336320	Federal Signal	COMX-120-260	COMMANDER PLUS, 20K LUMEN,	\$2,410.00	\$1,238.39
336320	Federal Signal	COMX-120-570	COM PLUS,28K LUM,120VAC FLOOD	\$3,048.00	\$1,566.23
336320	Federal Signal	COMX-120-800-08	COMMANDER PLUS, 28K LUMENS,12V	\$2,794.00	\$1,435.71
336320	Federal Signal	COMX-120-ON-530	COM PLUS,28K LUM ,120VAC,SIDE	\$3,326.00	\$1,709.08
336320	Federal Signal	COMX-120-ON-530SW	COM PLUS, 28K LUM, 120VAC	\$1,628.00	\$1,627.89
336320	Federal Signal	COMX-120-ON-600-603-P3	COM PLUS,28K LUM,120VAC,	\$3,845.00	\$1,975.77
336320	Federal Signal	COMX-120-ON-642-603	COM PLUS,28K LUM,120VAC,SMALL	\$3,845.00	\$1,975.77
336320	Federal Signal	COMX-240	COM PLUS,28K LUM,240VAC FLOOD	\$2,430.00	\$1,248.66

336320	Federal Signal	COMX-240-570	COM PLUS,28K LUM,240VAC FLOOD	\$2,771.00	\$1,423.89
336320	Federal Signal	COMX-240-ON-530	COM PLUS,28K LUM,240VAC,SIDE	\$3,024.00	\$1,553.89
336320	Federal Signal	COMX-DC	COM PLUS,28K LUM,12/24VDC	\$2,545.00	\$1,307.76
336320	Federal Signal	COMX-DC-260	COMMANDER PLUS,20K LUMEN,12/24	\$2,195.00	\$1,127.91
336320	Federal Signal	COMX-DC-530	COM PLUS,28K LUM,12/24VDC,SIDE	\$3,233.00	\$1,661.29
336320	Federal Signal	COMX-DC-530SW	COM PLUS,28K LUM,12/24VDC,SIDE	\$3,197.00	\$1,642.79
336320	Federal Signal	COMX-DC-570	COM PLUS,28K LUM,12/24VDC FLO	\$3,048.00	\$1,566.23
336320	Federal Signal	COMX-DC-ON-530	COM PLUS,28K LUM,12/24VDC,SIDE	\$3,326.00	\$1,709.08
336320	Federal Signal	COMX-S-120	COM PLUS-S,28K LUM,120VAC SPOT	\$2,894.00	\$1,487.09
336320	Federal Signal	COMX-S-120-570	COM PLUS-S,28K LUM,120VAC SPOT	\$3,269.00	\$1,679.79
336320	Federal Signal	COMX-S-120-ON-530	COM PLUS-S,28K LUM,120VAC,SIDE	\$3,598.00	\$1,848.85
336320	Federal Signal	COMX-S-120-ON-656	COM PLUS-S,28K LUM,120V,ON/OFF	\$3,532.00	\$1,814.93
336320	Federal Signal	COMX-S-240	COM PLUS-S,28K LUM,240VAC SPOT	\$2,630.00	\$1,351.44
336320	Federal Signal	COMX-S-240-ON-530	COM PLUS-S,28K LUM,240VAC,SIDE	\$3,271.00	\$1,680.82
336320	Federal Signal	COMX-S-DC	COM PLUS-S,28K LUM,12/24VDC SP	\$2,545.00	\$1,307.76
336320	Federal Signal	COMX-S-DC-570	COM PLUS-S,28K LUM,12/24VDC	\$3,048.00	\$1,566.23
336320	Federal Signal	COMX-S-DC-800-08	COM PLUS-S, 28K, 12/24VDC,	\$2,794.00	\$1,435.71
336320	Federal Signal	COMX-S-DC-ON-530	COM PLUS-S,28K LUM,12/24DC,SID	\$3,377.00	\$1,735.28
336320	Federal Signal	DSM	Kit, PA300 Series, bezel for dash mount	\$56.00	\$28.78
336320	Federal Signal	EQ2B-100	Electronic Q Siren, 100W	\$1,819.00	\$934.70
336320	Federal Signal	EQ2B-200	Electronic Q-Siren 200W, remote amplifier, surface mount control head	\$1,819.00	\$934.70
336320	Federal Signal	EQ2B-200FM	Electronic Q-Siren 200W, remote amplifier, flush mount control head	\$1,819.00	\$934.70
336320	Federal Signal	ES100-12FEVN	Speaker Kit, (2) ES100C, (2) ESB-12FEVN	\$688.00	\$353.53
336320	Federal Signal	ES100-12FHDC	Speaker Kit, (2) ES100C, (2) ESB-12FHDC	\$688.00	\$353.53
336320	Federal Signal	ES100-12RAMHD	Speaker Kit, (2) ES100C, (2) ESB-12RAMHD	\$808.00	\$415.19
336320	Federal Signal	ES100-14SPRNTR	ES100 Bracket Assembly, Kit, DS & PS	\$837.00	\$430.10
336320	Federal Signal	ES100C	DynaMax 100W Speaker	\$322.00	\$165.46
336320	Federal Signal	ES100C-CHP	Speaker, Emergency, 100W, CHP	\$403.00	\$207.08
336320	Federal Signal	ES100C-DEU	Speaker, ES100/DynaMax, 100W, high output, compact, Class A, with Deutsch connector	\$337.00	\$173.17
336320	Federal Signal	ES100-ESB-U-KIT	ES100C Speaker with mounting kit, Min quantities of 100	\$355.00	\$118.00
336320	Federal Signal	ES100-ESFMT-EFB	Speaker Kit, (2) ES100C, (2) ESFMT-EFB	\$758.00	\$389.50
336320	Federal Signal	ES100-ESFMT-LL	Speaker Kit, (2) ES100C, (2) ESFMT-LL	\$688.00	\$353.53
336320	Federal Signal	ES100-ESMFT-EF	Speaker Kit, (2) ES100C, (2) ESFMT-EF	\$688.00	\$353.53
336320	Federal Signal	ES100-FTH	Speaker Kit, (2) ES100C, (2) ESB-FTH-D	\$888.00	\$456.30
336320	Federal Signal	ES100-FTRANS	(2) DynaMax/ES100C speakers and bumper mount speaker housing kits, CA Title 13 compliant, Ford Transit, 2015-2018	\$888.00	\$456.30
336320	Federal Signal	ES100-SPRNTR	Speaker Kit, (2) ES100C, (2) ESB-SPRNTR-D/P	\$888.00	\$456.30
336320	Federal Signal	ES100-SPRNTR19	ES100 Bracket Assembly Kit, DS & PS	\$708.00	\$363.81
336320	Federal Signal	ES100-TERRA	Speaker Kit, (2) ES100C, (2) ESB-TERRA	\$688.00	\$353.53
336320	Federal Signal	ESB-12FHDC	Mount, ES100, 12 Ford HD Cntr	\$60.00	\$30.83
336320	Federal Signal	ESB-12RAMHD	Mount, ES100, 12 Ram HD	\$50.00	\$25.69
336320	Federal Signal	ESB-14SPRNTR-D	ES100 Bracket Assembly, Driver side	\$175.00	\$89.92
336320	Federal Signal	ESB-14SPRNTR-P	ES100 Bracket Assembly, Passenger side	\$175.00	\$89.92
336320	Federal Signal	ESB2-CHGR15	Bracket kit for mounting (2) DynaMax/ES100C speakers behind grille, Dodge Charger, 2015-2019	\$75.00	\$38.54
336320	Federal Signal	ESB2-FPIU20ND	No drill bracket for mounting (2) ES100C or (2) AS124 speaker behind the grille utilizing pre-drilled holes of the Ford Police Interceptor Utility 2020	\$75.00	\$38.54
336320	Federal Signal	ESB2-FPIUND	Bracket kit for mounting (2) DynaMax/ES100C speakers behind grille, Ford Police Interceptor Utility 2011 - 2018.	\$75.00	\$38.54
336320	Federal Signal	ESB2-FRD15ND	No drill mount bracket kit for mounting (2) ES100C speakers behind the grille utilizing pre-drilled holes of the Ford F150, 2018-2019, will work with Ecoboost.	\$75.00	\$38.54
336320	Federal Signal	ESB2-SILHD20ND	Bracket kit, dual ES100C, 2020 Silverado HD, no-drill	\$75.00	\$38.54
336320	Federal Signal	ESBCHGR15	Bracket Kit, ES100, Grille, Chgr15	\$40.00	\$20.55
336320	Federal Signal	ESB-DUR15	Bracket Kit, ES100, AS124, DUR15	\$40.00	\$20.55
336320	Federal Signal	ESB-EXP07	Speaker Bracket Ford Expedition, '07-'08	\$50.00	\$25.69
336320	Federal Signal	ESB-FPIU16	Combination bracket	\$50.00	\$25.69
336320	Federal Signal	ESB-FPIU20ND	No drill bracket for mounting (1) ES100C or (1) AS124 speaker behind the grille utilizing pre-drilled holes of the Ford Police Interceptor Utility 2020	\$40.00	\$20.55
336320	Federal Signal	ESB-FPIUND	Kit bracket for mounting ES100C - Ford Police Interceptor Utility	\$50.00	\$25.69
336320	Federal Signal	ESB-FRD15	ES100C Bracket Kit, FRD15, F150	\$50.00	\$25.69
336320	Federal Signal	ESB-FRD15ND	ES100C Bracket Kit, 2015-2017, F150	\$50.00	\$25.69
336320	Federal Signal	ESB-FTH-D	Bracket, 15 Ford Transit, Driver side	\$139.00	\$71.43

336320	Federal Signal	ESB-FTRANS-D	DynaMax/ES100C bumper mount speaker housing kit, Driver Side only, CA Title 13 compliant when mounted as a pair, Ford Transit, 2015-2018	\$139.00	\$71.43
336320	Federal Signal	ESB-FTRANS-P	DynaMax/ES100C bumper mount speaker housing kit, Passenger Side only, CA Title 13 compliant when mounted as a pair, Ford Transit, 2015-2018	\$139.00	\$71.43
336320	Federal Signal	ESB-IMP08R	Speaker Bracket Chevrolet Impala, '06-'11	\$50.00	\$25.69
336320	Federal Signal	ESBL2-DUR19ND	Kit, no drill, combination bracket for mounting (2) ES100C and (2) IPX6B/IPX3/MPS6/MPS6U/MPS12/MPSMW9 lights, Dodge Durango 2015-2019	\$75.00	\$38.54
336320	Federal Signal	ESBL2-TAH18ND	Bracket kit for mounting (2) DynaMax/ES100C speakers and (2) IPX600B/IPX300/MPS6/MPS6U/MPS12/MPS12U/MPSW9 behind grille utilizing pre-drilled holes, Chevy Tahoe 2018.	\$75.00	\$38.54
336320	Federal Signal	ESBL-FPIU20	Kit, combination bracket for mounting (1) ES100C and (2) IPX/MPS lights behind the grill of Ford Interceptor Utility 2020	\$40.00	\$20.55
336320	Federal Signal	ESBL-FUSN16ND	Kit, combination bracket for mounting a ES100C/DynaMax and (2) IPX600B/IPX300/MPS600/MPS600U/MPSW9 lights in the grille of 2016+ Ford Fusion.	\$50.00	\$25.69
336320	Federal Signal	ESBL-RAM16	Bracket Kit, ES-LTS, Grille, 16 Ram	\$40.00	\$20.55
336320	Federal Signal	ESBL-SIL17ND	Kit, combination bracket for mounting a ES100C/DynaMax and (2) IPX600B/IPX300/MPS600/MPS600U/MPSW9 lights in the grille of 2015-2017 Chevrolet Silverado SSV, can be used with 2017 shutters.	\$50.00	\$25.69
336320	Federal Signal	ESBL-TAH17ND	ES100C Bracket Kit for 2017 Chevrolet Tahoe PPV	\$40.00	\$20.55
336320	Federal Signal	ESBMT-SB	Speaker Bracket Bumper/surface mount bracket	\$56.00	\$28.78
336320	Federal Signal	ESB-SILHD20ND	Bracket kit, single ES100C, 2020 Silverado HD, no-drill	\$40.00	\$20.55
336320	Federal Signal	ESB-SPRNTR19-P	ES100 Bracket Assembly Kit, Passenger side	\$175.00	\$89.92
336320	Federal Signal	ESB-SPRNTR-D	ES100 Mounting Kit, Sprinter	\$145.00	\$74.51
336320	Federal Signal	ESB-SPRNTRP	ES100 Mounting Kit, Sprinter	\$145.00	\$74.51
336320	Federal Signal	ESB-TAH15	ES100 C/E Mounting Kit, Tahoe	\$40.00	\$20.55
336320	Federal Signal	ESB-TAH17ND	ES100C Bracket Kit, 2017-2020 Chevy Tahoe, no drill, combination kit, (1) ES100C and (2) IPX/MPS lights behind grille.	\$40.00	\$20.55
336320	Federal Signal	ESB-TAR11	ES100 Mounting Kit, Taurus 2011	\$50.00	\$25.69
336320	Federal Signal	ESB-TERRA	ES100 Mounting Kit, 2016 Terrastar	\$120.00	\$61.66
336320	Federal Signal	ESB-TRAV16ND	ES100 Mounting Kit, 2016 Trav, No Drill	\$50.00	\$25.69
336320	Federal Signal	ESB-U	Speaker Bracket Universal bail bracket, all vehicles	\$40.00	\$20.55
336320	Federal Signal	ESFMT	Speaker Bracket Recess mount, polished trim ring	\$84.00	\$43.16
336320	Federal Signal	ESFMT-EF	Recess mount, stainless steel "Electric F" grille	\$74.00	\$38.03
336320	Federal Signal	ESFMT-LL	ES100 Flush Mounting Kit	\$74.00	\$38.03
336320	Federal Signal	ESMFT-EFB	Mount, Flush, Black, Grille	\$75.00	\$38.54
336320	Federal Signal	EXPHARN01	Rear taillight connections wire harness for use with expansion module, Dodge Charger Pursuit, 2015-2019	\$150.00	\$77.08
336320	Federal Signal	EXPHARN02	Rear taillight connections wire harness for use with expansion module, Chevy Tahoe, 2015-2019	\$150.00	\$77.08
336320	Federal Signal	EXPHARN03	Rear taillight connections wire harness for use with expansion module, Ford Interceptor Utility, 2020	\$150.00	\$77.08
336320	Federal Signal	EXPHARN04	Connection wire harness for rear taillight and rear liftgate for use with rear expansion module, Dodge Durango, 2018-2020.	\$334.00	\$171.63
336320	Federal Signal	EXPMOD-2	Expansion Module, (18) solid state programmable relay outputs, (16) 7.5 Amp flashing outputs, and (2) 20 Amp control outputs.	\$650.00	\$334.01
336320	Federal Signal	EXPMOD24	24 Channel Expansion Module - for use with Pathfinder Sirens	\$325.00	\$167.00
336320	Federal Signal	FA3-SC	Intelli-Flash 90 FPM, (2) 10A loads, high-side switching	\$57.00	\$29.29
336320	Federal Signal	FHL2-SC	Headlight Flasher	\$96.00	\$49.33
336320	Federal Signal	FHL-CHG	Flasher, Headlight, '06-newer, Dodge Charger	\$101.00	\$51.90
336320	Federal Signal	FHL-HL	Flasher, Headlight, positive-side switched systems	\$89.00	\$45.73
336320	Federal Signal	FHLP-CP	Flasher, Headlight, Chevrolet Caprice, "plug-n-play" connectors	\$120.00	\$61.66
336320	Federal Signal	FHLP-IMP	Flasher, Headlight Impala Police Package	\$146.00	\$75.02
336320	Federal Signal	FHLP-TAH	Flasher, Headlight, '06-newer, Tahoe with "plug-n-play" connectors	\$135.00	\$69.37
336320	Federal Signal	FHL-TAIL	Flasher, Taillight, universal applications, 18" wire leads	\$87.00	\$44.71
336320	Federal Signal	FHPCHARGER-LBPB	FHP Charger Lightbar/push bumper vehicle lighting package to include (14) MPS62OU-BW, (2) XSM1-BRW-US, (4) 416300-B, (2) 750501, (1) PF200, (1) VALR44S-FHP, (1) SIFMRS-FHP, (2) MPS62OU-BR	\$10,569.00	\$5,430.92
336320	Federal Signal	FHPCHARGER-STPB	FHP Charger Slicktop/push bumper vehicle lighting package to include: (1) SIFMS-1526402703, (14) MPS62OU-BW, (2) MPS650-BB, (4) 416300-B, (2) 750501, (1) PF200, (1) SIFMRS-FHP, (2) MPS62OU-BR	\$8,083.00	\$4,153.48



336320	Federal Signal	FHP-CHARGER-UM	FHP Charger Unmarked vehicle lighting package to include: (1) SIFMS-1526402703, (10) MPS620U-BW, (2) MPS650-BB, (4) 416300-B, (1) PF200, (1) SIFMRS-FHP, (2) MPS620U-BR, (2) ES100C, (1) IPX-GRL8	\$7,619.00	\$3,915.05
336320	Federal Signal	FHP-CHARGER-UM-BCII	FHP Charger Unmarked vehicle lighting package to include: (1) SIFMS-1526402703, (2) MPS620U-BW, (2) MPS650-BB, (1) PF200, (1) SIFMRS-FHP, (2) ES100C, (1) IPX-GRL8	\$5,563.00	\$2,858.57
336320	Federal Signal	FHPCHARGER-UMPB	FHP Charger Unmarked / Push Bumper vehicle lighting package to include: (14) MPS620U-BW, (2) MPS650-BB, (4) 416300-B, (2) 750501, (1) PF200, (1) SIFMRS-FHP, (2) MPS620U-BR, (2) XSM1-BRW-US	\$7,031.00	\$3,612.91
336320	Federal Signal	FHPEXPEDITION-UM	FHP Expedition Unmarked vehicle lighting package to include: (12) MPS620U-BW, (2) MPS650-BB, (6) 416300-B, (1) PF200, (2) MPS620U-BR, (2) XSM1-BRW-US, (2) ES100C, (1) CNSM8R-1525362135, (1) FHL-HL,(1) FHL-TAIL, (2) IPX-GRL8	\$6,572.00	\$3,377.05
336320	Federal Signal	FHPEXPEDITION-UMPB	FHP Expedition Unmarked / Push Bumper vehicle lighting package to include: (14) MPS620U-BW, (2) MPS650-BB, (6) 416300-B, (1) PF200, (2) MPS620U-BR, (2) XSM1-BRW-US, (2) ES100C, (1) CNSM8R-1525362135, (1) FHL-HL,(1) FHL-TAIL,	\$6,964.00	\$3,578.48
336320	Federal Signal	FHPEXPLORER-LBPB	FHP Explorer Lightbar/Push Bumper vehicle lighting package to include: (14) MPS620U-BW, (2) MPS650-BB, (8) 416300-B, (1) PF200, (2) MPS620U-BR, (1) FHL-CHG,(1) FHL-TAIL, (2) XSM1-BRW-US, (2) 416910-R, (1) SIFMHS-FHPFPIU , (2) 750501, (1) VALR44S-FHP	\$10,959.00	\$5,631.32
336320	Federal Signal	FHPEXPLORER-STPB	FHP vehicle lighting package to include: (14) MPS620U-BW, (4) MPS650-BB, (8) 416300-B, (1) PF200, (2) MPS620U-BR, (2) 416910-R, (1) SIFMH-1525359435, (6) MPS620U-BA, (1) MPMS6-FPIURS2, (2) 750501	\$8,307.00	\$4,268.58
336320	Federal Signal	FHPEXPLORER-UM	FHP Explorer Unmarked vehicle lighting package to include: (10) MPS620U-BW, (4) MPS650-BB, (8) 416300-B, (1) PF200, (2) MPS620U-BR, (1) FHL-CHG,(1) FHL-TAIL, (2) 416910-R, (2) ES100C, (1) SIFMS-1525359435, (1) SIFMH-1526495768, (1) IPX-GRL8	\$8,491.00	\$4,363.13
336320	Federal Signal	FHPEXPLORER-UM BCII	FHP Explorer Unmarked vehicle lighting package to include: (2) MPS620U-BW, (4) MPS650-BB, (2) 416300-B, (1) PF200, (2) 416910-R, (2) ES100C, (1) SIFMS-1525359435, (1) SIFMHS-FHPFPIU (1) IPX-GRL10	\$6,271.00	\$3,222.38
336320	Federal Signal	FHPEXPLORER-UMPB	FHP vehicle lighting package to include: (14) MPS620U-BW, (4) MPS650-BB, (8) 416300-B, (1) PF200, (2) MPS620U-BR, (1) FHL-CHG,(1) FHL-TAIL, (2) 416910-R, (1) SIFMH-1526495768, (2) 750501, (2) XSM1-BRW-US	\$7,903.00	\$4,060.99
336320	Federal Signal	FHPF150-LBPB	FHP F 150 Lightbar/push bumper vehicle lighting package to include (8) MPS620U-BW, (2) XSM1-BRW-US, (2) 416300-B, (1) PF200, (1) VALR51S-FHP, (2) MPS620U-BR, (6) MPS652-BW, (1) FHL-HL, (1) FHL-TAIL, (2) 750501	\$9,291.00	\$4,774.22
336320	Federal Signal	FHP-F150-STPB	FHP Package to include (1) SIFMS-F150-FHP, (1) CNSM8RS-SU-3909646, (8) MPS620U-BW, (2) MPS650-BB, (2) 416300-B, (1) PF200, (2) 750501, (2) MPS620U-BR, (6) MPS652-BW, (1) FHL-CHG, (1) FHL-TAIL, (1) OBDIICABLE6-1	\$7,660.00	\$3,936.12
336320	Federal Signal	FHPRAM1500-UM	FHP vehicle lighting package to include: (2) MPS620U-BW, (2) 416300-B, (1) PF200, (1) FHL-CHG,(1) FHL-TAIL, (4) 416910-B, (2) ES100C, (1) SIFZS-1525361484, (1) CNSM8R-1525362135	\$5,451.00	\$2,801.02
336320	Federal Signal	FHPTAHOE-LBPB	FHP Tahoe Lightbar/Push Bumper vehicle lighting package to include: (1) VALR51S-FHP, (14) MPS620U-BW, (8) 416300-B, (1) PF200, (1) FHL-CHG,(1) FHL-TAIL, (2) XSM1-BRW-US, (2) MPS620U-BR, (1) SIFMHS-FHPTAH, (2) 750501,	\$10,964.00	\$5,633.89
336320	Federal Signal	FHPTAHOE-STPB	FHP Tahoe Slicktop / Push Bumper vehicle lighting package to include: (14) MPS620U-BW, (8) 416300-B, (1) PF200, (1) FHL-CHG,(1) FHL-TAIL, (2) MPS620U-BR, (1) MPMS6-TAH15RS, (6) MPS620U-BA, (2) 750501, (1) SIFMS-1525352045, (2) MPS650-BB	\$7,963.00	\$4,091.82
336320	Federal Signal	FHP-TAHOE-UM	FHP Tahoe Unmarked vehicle lighting package to include: (1) SIFMS-1525352045, (10) MPS620U-BW, (2) MPS650-BB, (1) PF200, (1) SIFMHS-FHPTAH, (2) ES100C, (1) IPX-GRL7, (1) OBDIICABLE6-1, (8) 416300-B, (2) MPS620U-BR, (1) FHL-CHG, (2) 416910-R, (1) FHL-TAIL.	\$8,598.00	\$4,418.12
336320	Federal Signal	FHPTAURUS-UM	FHP Taurus Unmarked vehicle lighting package to include: (2) MPS620U-BW, (6) 416300-B, (1) PF200, (1) FHL-TAIL, (1) SIFMS-1525364866, (2) MPS650-BB, (1) SILSD-1526498245, (2) 416910-B, (2) ES100C, (2) 416910-R, (1) IPX-GRL8	\$6,562.00	\$3,371.91
336320	Federal Signal	FL3SF-012SB	Night-Flighter Area light, 12V, spot/flood light	\$1,342.00	\$689.59

336320	Federal Signal	FL3SF-LC	Night-Fighter Area light, low current, three-lamp spot/flood light	\$1,400.00	\$719.40
336320	Federal Signal	FL3SF-R-LC	Night-Fighter Area light, low current, three-lamp spot/flood light with remote power switch	\$1,500.00	\$770.78
336320	Federal Signal	FL3TK-1	Night-Fighter Kit, 4" telescopic pole	\$340.00	\$174.71
336320	Federal Signal	FM-PM CITY	Promaster Kit, Mounting foot	\$179.00	\$91.98
336320	Federal Signal	FR4-A	FireRay LED 4X3, Single color, Color lens, Built-in flasher, Amber LEDs, Amber lens	\$180.00	\$92.49
336320	Federal Signal	FR4-A4HMC	FireRay 4X3, 4-hole mount adapter bezel	\$30.00	\$15.42
336320	Federal Signal	FR4-B	FireRay LED 4X3, Single color, Color lens, Built-in flasher, Blue LEDs, Blue lens	\$180.00	\$92.49
336320	Federal Signal	FR4C-A	FireRay LED 4X3, Single color, Clear lens, Built-in flasher, Amber	\$180.00	\$92.49
336320	Federal Signal	FR4C-AW	FireRay LED 4X3, Split color, Clear lens, Built-in flasher, Amber/white	\$180.00	\$92.49
336320	Federal Signal	FR4C-B	FireRay LED 4X3, Single color, Clear lens, Built-in flasher, Blue	\$180.00	\$92.49
336320	Federal Signal	FR4C-BA	FireRay 400 Series, Split	\$180.00	\$92.49
336320	Federal Signal	FR4C-BW	FireRay 400 Series, Split	\$180.00	\$92.49
336320	Federal Signal	FR4C-G	FireRay 400 Series, Green LED	\$180.00	\$92.49
336320	Federal Signal	FR4C-R	FireRay LED 4X3, Single color, Clear lens, Built-in flasher, Red	\$180.00	\$92.49
336320	Federal Signal	FR4C-RA	FireRay 400 Series, Split	\$180.00	\$92.49
336320	Federal Signal	FR4C-RB	FireRay LED 4X3, Split color, Clear lens, Built-in flasher, Red/Blue	\$180.00	\$92.49
336320	Federal Signal	FR4C-RW	FireRay LED 4X3, Split color, Clear lens, Built-in flasher, Red/white	\$180.00	\$92.49
336320	Federal Signal	FR4C-W	FireRay LED 4X3, Single color, Clear lens, Built-in flasher, White	\$180.00	\$92.49
336320	Federal Signal	FR4-G	FireRay 400 Series, Green LED	\$200.00	\$102.77
336320	Federal Signal	FR4-R	FireRay LED 4X3, Single color, Color lens, Built-in flasher, Red LEDs, Red lens	\$180.00	\$92.49
336320	Federal Signal	FR6-A	FireRay LED 6X4, Single color, Color lens, Built-in flasher, Amber LEDs, Amber lens.	\$217.00	\$111.51
336320	Federal Signal	FR6-A4HMC	Mounting kit to convert FireRay 6X4 to fit in QuadraFlare6X4 mounting holes	\$35.00	\$17.98
336320	Federal Signal	FR6-ARROW	FireRay LED 6X4, Arrow, Amber LEDs, Amber lens.	\$145.00	\$74.51
336320	Federal Signal	FR6-B	FireRay LED 6X4, Single color, Color lens, Built-in flasher, Blue LEDs, Blue lens.	\$217.00	\$111.51
336320	Federal Signal	FR6-BACKUP	FireRay LED 6X4, Back-up, White LEDs, Clear lens.	\$211.00	\$108.42
336320	Federal Signal	FR6-BTT	FireRay LED 6X4, Brake/Tail/Turn, Red LEDs, Red lens.	\$158.00	\$81.19
336320	Federal Signal	FR6C-A	FireRay LED 6X4, Single color, Clear lens, Built-in flasher, Amber LEDs,	\$217.00	\$111.51
336320	Federal Signal	FR6C-AW	FireRay LED 6X4, Split color, Clear lens, Built-in flasher, Amber/White	\$217.00	\$111.51
336320	Federal Signal	FR6C-B	FireRay LED 6X4, Single color, Clear lens, Built-in flasher, Blue LEDs,	\$217.00	\$111.51
336320	Federal Signal	FR6C-BA	FireRay 600 Series, Split	\$217.00	\$111.51
336320	Federal Signal	FR6C-BW	FireRay LED 6X4, Split color, Clear lens, Built-in flasher, Blue/White	\$217.00	\$111.51
336320	Federal Signal	FR6C-G	FireRay 600 Series, Green LED	\$217.00	\$111.51
336320	Federal Signal	FR6C-R	FireRay LED 6X4, Single color, Clear lens, Built-in flasher, Red LEDs,	\$217.00	\$111.51
336320	Federal Signal	FR6C-RA	FireRay 600 Series, Split	\$217.00	\$111.51
336320	Federal Signal	FR6C-RB	FireRay LED 6X4, Split color, Clear lens, Built-in flasher, Red/Blue	\$217.00	\$111.51
336320	Federal Signal	FR6C-RW	FireRay LED 6X4, Split color, Clear lens, Built-in flasher, Red/White	\$217.00	\$111.51
336320	Federal Signal	FR6C-W	FireRay LED 6X4, Single color, Clear lens, Built-in flasher, White LEDs,	\$217.00	\$111.51
336320	Federal Signal	FR6-G	FireRay 600 Series, Green LED	\$237.00	\$121.78
336320	Federal Signal	FR6LEDSCENE	FireRay LED Scene Lights, Surface mount, White LEDs, Clear Lens, 6X4	\$370.00	\$190.13
336320	Federal Signal	FR6MB3V	FireRay LED Perimeter Light Bezels - 3 position vertical casting, black	\$190.00	\$97.63
336320	Federal Signal	FR6MC3V	FireRay LED Perimeter Light Bezels - 3 position vertical casting, chrome	\$190.00	\$97.63
336320	Federal Signal	FR6MC4V	FireRay, FR6 Flange, Chrome, 4-up	\$190.00	\$97.63
336320	Federal Signal	FR6MHL	FireRay LED 6X4, Headlight mount kit.	\$48.00	\$24.66
336320	Federal Signal	FR6-R	FireRay LED 6X4, Single color, Color lens, Built-in flasher, Red LEDs, Red lens.	\$217.00	\$111.51
336320	Federal Signal	FR7-A	FireRay LED 7X3, single color, Color lens, Built-in flasher, Amber LEDs, Amber lens.	\$215.00	\$110.48
336320	Federal Signal	FR7-A4HMC	FireRay 7X3, 4-hole mount adapter bezel	\$45.00	\$23.12

336320	Federal Signal	FR7-B	FireRay LED 7X3, single color, Color lens, Built-in flasher, Blue LEDs, Blue lens.	\$215.00	\$110.48
336320	Federal Signal	FR7C-A	FireRay LED 7X3, single color, Clear lens, Built-in flasher, Amber LEDs	\$215.00	\$110.48
336320	Federal Signal	FR7C-AW	FireRay LED 7X3, Split color, Clear lens, Built-in flasher, Amber/White	\$215.00	\$110.48
336320	Federal Signal	FR7C-B	FireRay LED 7X3, single color, Clear lens, Built-in flasher, Blue LEDs	\$215.00	\$110.48
336320	Federal Signal	FR7C-BA	FireRay 700 Series, Split	\$215.00	\$110.48
336320	Federal Signal	FR7C-BW	FireRay LED 7X3, Split color, Clear lens, Built-in flasher, Blue/White	\$215.00	\$110.48
336320	Federal Signal	FR7C-R	FireRay LED 7X3, single color, Clear lens, Built-in flasher, Red LEDs	\$215.00	\$110.48
336320	Federal Signal	FR7C-RA	FireRay LED 7X3, Split color, Clear lens, Built-in flasher, Red/Amber	\$215.00	\$110.48
336320	Federal Signal	FR7C-RB	FireRay LED 7X3, Split color, Clear lens, Built-in flasher, Red/Blue	\$215.00	\$110.48
336320	Federal Signal	FR7C-RW	FireRay LED 7X3, Split color, Clear lens, Built-in flasher, Red/White	\$215.00	\$110.48
336320	Federal Signal	FR7C-W	FireRay LED 7X3, single color, Clear lens, Built-in flasher, White LEDs	\$215.00	\$110.48
336320	Federal Signal	FR7-G	FireRay 700 Series, Green LED	\$235.00	\$120.76
336320	Federal Signal	FR7LEDSCENE	FireRay LED Scene Lights, Surface mount, White LEDs, Clear Lens, 7X3	\$370.00	\$190.13
336320	Federal Signal	FR7MB	FireRay FR7 Series, Black Trim Ring	\$20.00	\$10.28
336320	Federal Signal	FR7MC	FireRay LED 7X3, Trim Bezel, Chrome	\$20.00	\$10.28
336320	Federal Signal	FR7NB	FireRay LED 7X3, Trim Bezel, Black	\$20.00	\$10.28
336320	Federal Signal	FR7-R	FireRay LED 7X3, single color, Color lens, Built-in flasher, Red LEDs, Red lens.	\$215.00	\$110.48
336320	Federal Signal	FR9=G	FireRay 900 Series, Green LED	\$345.00	\$177.28
336320	Federal Signal	FR9-A	FireRay LED 9X7, Single color, Color lens, built-in flasher, Amber LED, Amber lens	\$325.00	\$167.00
336320	Federal Signal	FR9-A4HMC	FireRay 9X7, 4-hole mount adapter bezel	\$55.00	\$28.26
336320	Federal Signal	FR9-ARROW	FireRay 900 Series, Arrow	\$390.00	\$200.40
336320	Federal Signal	FR9-B	FireRay LED 9X7, Single color, Color lens, built-in flasher, Blue LED, Blue lens	\$325.00	\$167.00
336320	Federal Signal	FR9-BACKUP	FireRay 900 Series, with gasket.	\$411.00	\$211.19
336320	Federal Signal	FR9-BTT	FireRay 900 Series, BTT	\$354.00	\$181.90
336320	Federal Signal	FR9C-A	FireRay LED 9X7, Single color, Clear lens, built-in flasher, Amber	\$325.00	\$167.00
336320	Federal Signal	FR9C-ARROW	FireRay LED 9X7 Arrow, Amber LEDs, Amber lens	\$390.00	\$200.40
336320	Federal Signal	FR9C-B	FireRay LED 9X7, Single color, Clear lens, built-in flasher, Blue	\$325.00	\$167.00
336320	Federal Signal	FR9C-G	FireRay 900 Series, Green LED	\$345.00	\$177.28
336320	Federal Signal	FR9C-R	FireRay LED 9X7, Single color, Clear lens, built-in flasher, Red	\$325.00	\$167.00
336320	Federal Signal	FR9C-W	FireRay LED 9X7, Single color, Clear lens, built-in flasher, White	\$325.00	\$167.00
336320	Federal Signal	FR9LEDSCENE	FireRay LED Scene Lights, Surface mount, White LEDs, Clear Lens, 9X7	\$525.00	\$269.77
336320	Federal Signal	FR9MB	FireRay LED 9X7 Trim Bezel, Black	\$20.00	\$10.28
336320	Federal Signal	FR9MBSCENE	FireRay FR9 Series, Black Trim Ring	\$20.00	\$10.28
336320	Federal Signal	FR9MC	FireRay LED 9X7 Trim Bezel, Chrome	\$20.00	\$10.28
336320	Federal Signal	FR9MCSCENE	FireRay FR9 Series, Chrome Trim Ring	\$20.00	\$10.28
336320	Federal Signal	FR9-R	FireRay LED 9X7, Single color, Color lens, built-in flasher, Red LED, Red lens	\$325.00	\$167.00
336320	Federal Signal	FR-F150FOG	Pair of fog light brackets, each bracket holds (1) FireRay 4X3 light in each fog light of the Ford F150, 2018-2019	\$34.00	\$17.47
336320	Federal Signal	FRPC-BTT	FireRay 900 Series, BTT	\$354.00	\$181.90
336320	Federal Signal	GHFLANGE	Rectangular shaped GHSCENE trim ring	\$45.00	\$23.12
336320	Federal Signal	GHSCENE	Area Light, GHSCENE, (2) 20W adjustable lamps, Clear lens	\$179.00	\$91.98
336320	Federal Signal	GL1-A	GL1 LED LGHTRD, AMBER	\$199.00	\$102.26
336320	Federal Signal	GL1-R	GL1 LED LIGHTHEAD, RED	\$199.00	\$102.26
336320	Federal Signal	GL5-B	PERIM LT, FIRERAY LED	\$309.00	\$158.78
336320	Federal Signal	GL5KIT-B	GL5 RETROFIT LIGHT, BLUE	\$230.00	\$118.19
336320	Federal Signal	GL5KIT-G	RETROFIT KIT, GREEN, GL	\$220.00	\$113.05
336320	Federal Signal	GL5KIT-R	GL5 Retrofit Light, Red	\$230.00	\$118.19
336320	Federal Signal	HKB-CAP11B	KIT, HOOK, UNDER TRIM,	\$65.00	\$33.40
336320	Federal Signal	HKB-CAR8	Hook Mount	\$65.00	\$33.40
336320	Federal Signal	HKB-CARV	Mounting Hook Kit, 96 car	\$70.00	\$35.97
336320	Federal Signal	HKB-CHGR	Hook Mount	\$79.00	\$40.59
336320	Federal Signal	HKB-CHGR11	Hook Mount	\$65.00	\$33.40

336320	Federal Signal	HKB-CK	KIT,HOOK,JET,VISION,CHEVY	\$70.00	\$35.97
336320	Federal Signal	HKB-CK2	Hook Mount	\$79.00	\$40.59
336320	Federal Signal	HKB-COL15	Lightbar Hook Kit - 2015-2016 Chevrolet Colorado Crew Cab. 44/45/46 inch lightbars	\$79.00	\$40.59
336320	Federal Signal	HKB-COL7	Hook Mount	\$79.00	\$40.59
336320	Federal Signal	HKB-CV92	Hook Mount	\$79.00	\$40.59
336320	Federal Signal	HKB-DKTA	Hook Mount	\$79.00	\$40.59
336320	Federal Signal	HKB-DUR11	Hook Kit, 2019 Dodge Durango	\$70.00	\$35.97
336320	Federal Signal	HKB-DUR8	Hook Mount	\$70.00	\$35.97
336320	Federal Signal	HKB-DURR	KIT HOOK,05DURANGO W/ROOF	\$79.00	\$40.59
336320	Federal Signal	HKB-ESC13	KIT,HOOK,ESCAPE,2013 FORD	\$79.00	\$40.59
336320	Federal Signal	HKB-ESC7	Hook Mount	\$79.00	\$40.59
336320	Federal Signal	HKB-FHD7	Hook Mount	\$79.00	\$40.59
336320	Federal Signal	HKB-FPIU13-44	Hook mount kit - Ford Interceptor Utility - 44/45/46" lightbars	\$79.00	\$40.59
336320	Federal Signal	HKB-FPIU13B	Hook mount kit - Ford Interceptor Utility - 51/51" lightbars	\$79.00	\$40.59
336320	Federal Signal	HKB-FPIU18	Mounting Hook Kit, 18 FPIU,RDM	\$79.00	\$40.59
336320	Federal Signal	HKB-FPIU20	Hook kit, use with 44", 45", 46", 51", and 53" light bars, Ford Police Interceptor Utility 2020	\$79.00	\$40.59
336320	Federal Signal	HKB-FRD15	KIT,HOOK,15 F150,51" BARS	\$79.00	\$40.59
336320	Federal Signal	HKB-FRD15-44	KIT,HOOK,15 F150,44" BARS	\$79.00	\$40.59
336320	Federal Signal	HKB-FRD4	Hook Mount	\$70.00	\$35.97
336320	Federal Signal	HKB-FRD7	Hook Mount	\$79.00	\$40.59
336320	Federal Signal	HKB-FRD9	Hook Mount	\$79.00	\$40.59
336320	Federal Signal	HKB-FTEX	Hook Mount	\$79.00	\$40.59
336320	Federal Signal	HKB-GUTR	KIT,HOOK,JET & VISION,GUT	\$79.00	\$40.59
336320	Federal Signal	HKB-IMP7	Hook Mount	\$70.00	\$35.97
336320	Federal Signal	HKB-LPCHGR11	KIT, LOW-PRO, 11 CHRGR, HOOK	\$79.00	\$40.59
336320	Federal Signal	HKB-MAG7	Mounting Hook Kit, 2007, Magnum	\$79.00	\$40.59
336320	Federal Signal	HKB-MAL7	Hook Mount	\$79.00	\$40.59
336320	Federal Signal	HKB-RAM2	Hook Mount	\$70.00	\$35.97
336320	Federal Signal	HKB-RMQ4	Hook Mount	\$70.00	\$35.97
336320	Federal Signal	HKB-RNG19	Hook Kit, 2019 Ford Ranger	\$70.00	\$35.97
336320	Federal Signal	HKB-S10	HOOK,S10 CHEVY	\$79.00	\$40.59
336320	Federal Signal	HKB-SAV	Hook Mount	\$79.00	\$40.59
336320	Federal Signal	HKB-SIL17	Light bar hook mount kit, 2015-2017 Chevrolet Silverado 51"/53" light bars	\$79.00	\$40.59
336320	Federal Signal	HKB-SIL17-44	Light bar hook mount kit, 2015-2017 Chevrolet Silverado 44"/45"" light bars	\$79.00	\$40.59
336320	Federal Signal	HKB-TA07	Hook Mount	\$79.00	\$40.59
336320	Federal Signal	HKB-TA10	Hook Mount	\$79.00	\$40.59
336320	Federal Signal	HKB-TAH15-44	KIT,15 TAHOE,44" BAR,HOOK	\$79.00	\$40.59
336320	Federal Signal	HKB-TAR11	Hook Mount	\$79.00	\$40.59
336320	Federal Signal	HKB-TCON	KIT,HOOK, 2015 TRANSIT CONNECT	\$79.00	\$40.59
336320	Federal Signal	HKB-WSTR	Hook Mount	\$70.00	\$35.97
336320	Federal Signal	HKB-XPL8	Hook Mount	\$79.00	\$40.59
336320	Federal Signal	HL10M-A	Suction cup magnet mount, cigarette plug, on/off switch, Single Color, Amber dome, Amber LEDs	\$220.00	\$113.05
336320	Federal Signal	HL10MC-A	Suction cup magnet mount, cigarette plug, on/off switch, Single Color, Clear dome, Amber LEDs	\$220.00	\$113.05
336320	Federal Signal	HL10MC-AB	Suction cup magnet mount, cigarette plug, on/off switch, Single Color, Clear dome, Amber/Blue LEDs	\$220.00	\$113.05
336320	Federal Signal	HL10MC-AG	Suction cup magnet mount, cigarette plug, on/off switch, Single Color, Clear dome, Amber/Green LEDs	\$220.00	\$113.05
336320	Federal Signal	HL10MC-AR	Suction cup magnet mount, cigarette plug, on/off switch, Single Color, Clear dome, Amber/Red LEDs	\$220.00	\$113.05
336320	Federal Signal	HL10MC-AW	Suction cup magnet mount, cigarette plug, on/off switch, Single Color, Clear dome, Amber/White LEDs	\$220.00	\$113.05
336320	Federal Signal	HL10MC-B	Suction cup magnet mount, cigarette plug, on/off switch, Single Color, Clear dome, Blue LEDs	\$220.00	\$113.05
336320	Federal Signal	HL10MC-G	Suction cup magnet mount, cigarette plug, on/off switch, Single Color, Clear dome, Green LEDs	\$220.00	\$113.05
336320	Federal Signal	HL10MC-R	Suction cup magnet mount, cigarette plug, on/off switch, Single Color, Clear dome, Red LEDs	\$220.00	\$113.05
336320	Federal Signal	HL10MC-W	Suction cup magnet mount, cigarette plug, on/off switch, Single Color, Clear dome, White LEDs	\$220.00	\$113.05
336320	Federal Signal	HL10P-A	Permanent mount, Single Color, Amber dome, Amber LEDs	\$210.00	\$107.91
336320	Federal Signal	HL10PC-A	Permanent mount, Single Color, Clear dome, Amber LEDs	\$210.00	\$107.91
336320	Federal Signal	HL10PC-AB	Permanent mount, Single Color, Clear dome, Amber/Blue LEDs	\$210.00	\$107.91

336320	Federal Signal	HL10PC-AG	Permanent mount, Single Color, Clear dome, Amber/Green LEDs	\$210.00	\$107.91
336320	Federal Signal	HL10PC-AR	Permanent mount, Single Color, Clear dome, Amber/Red LEDs	\$210.00	\$107.91
336320	Federal Signal	HL10PC-AW	Permanent mount, Single Color, Clear dome, Amber/White LEDs	\$210.00	\$107.91
336320	Federal Signal	HL10PC-B	Permanent mount, Single Color, Clear dome, Blue LEDs	\$210.00	\$107.91
336320	Federal Signal	HL10PC-G	Permanent mount, Single Color, Clear dome, Green LEDs	\$210.00	\$107.91
336320	Federal Signal	HL10PC-R	Permanent mount, Single Color, Clear dome, Red LEDs	\$210.00	\$107.91
336320	Federal Signal	HL10PC-W	Permanent mount, Single Color, Clear dome, White LEDs	\$210.00	\$107.91
336320	Federal Signal	HL10S-A	Suction cup magnet mount, cigarette plug, on/off switch, Single Color, Amber dome, Amber LEDs	\$230.00	\$118.19
336320	Federal Signal	HL10SC-A	Suction cup magnet mount, cigarette plug, on/off switch, Single Color, Clear dome, Amber LEDs	\$230.00	\$118.19
336320	Federal Signal	HL10SC-AB	Suction cup magnet mount, cigarette plug, on/off switch, Single Color, Clear dome, Amber/Blue LEDs	\$230.00	\$118.19
336320	Federal Signal	HL10SC-AG	Suction cup magnet mount, cigarette plug, on/off switch, Single Color, Clear dome, Amber/Green LEDs	\$230.00	\$118.19
336320	Federal Signal	HL10SC-AR	Suction cup magnet mount, cigarette plug, on/off switch, Single Color, Clear dome, Amber/Red LEDs	\$230.00	\$118.19
336320	Federal Signal	HL10SC-AW	Suction cup magnet mount, cigarette plug, on/off switch, Single Color, Clear dome, Amber/White LEDs	\$230.00	\$118.19
336320	Federal Signal	HL10SC-B	Suction cup magnet mount, cigarette plug, on/off switch, Single Color, Clear dome, Blue LEDs	\$230.00	\$118.19
336320	Federal Signal	HL10SC-G	Suction cup magnet mount, cigarette plug, on/off switch, Single Color, Clear dome, Green LEDs	\$230.00	\$118.19
336320	Federal Signal	HL10SC-R	Suction cup magnet mount, cigarette plug, on/off switch, Single Color, Clear dome, Red LEDs	\$230.00	\$118.19
336320	Federal Signal	HL10SC-W	Suction cup magnet mount, cigarette plug, on/off switch, Single Color, Clear dome, White LEDs	\$230.00	\$118.19
336320	Federal Signal	HRX01	HRX Series Headache Rack,	\$499.00	\$256.41
336320	Federal Signal	HRX-CABLE	Cable, Headache Rack	\$78.00	\$40.08
336320	Federal Signal	HRX-HL	Bracket, Mounting, Highlighter	\$60.00	\$30.83
336320	Federal Signal	HRX-LB45	HRX Bracket Kit, 45" Bars	\$65.00	\$33.40
336320	Federal Signal	ILSKIT-01	KIT,ILSS,S/O,FORD SEDAN	\$219.00	\$112.53
336320	Federal Signal	ILSKIT-02	KIT,ILSS,S/O,FORD UTILITY	\$219.00	\$112.53
336320	Federal Signal	ILSKIT-03	KIT,ILSS,S/O,DODGE CHARGER	\$219.00	\$112.53
336320	Federal Signal	ILSKIT-05	ILSS Kit, S/O, Chevy Tahoe 15	\$219.00	\$112.53
336320	Federal Signal	ILSKIT-06	KIT,ILSFD,S/O,FORD SEDAN	\$219.00	\$112.53
336320	Federal Signal	INTG1-FHP-PACKAGE-MARK-CHGR	Package includes 44" Integrity Lightbar, SSP-2000B-200 Siren, AS124 Speaker-Vertical Mount (2), Speaker mounting bracket (2)	\$5,185.00	\$2,664.33
336320	Federal Signal	INTG44J-F1H	44 IN., Red/White, White TD/Alley Lights, Amber SignalMaster, Hook mount.	\$3,340.00	\$1,716.27
336320	Federal Signal	INTG44J-F1HM	44 IN., Red/White, White TD/Alley Lights, Amber SignalMaster, Serial Interface Module, Hook mount.	\$3,410.00	\$1,752.24
336320	Federal Signal	INTG44J-F2H	44 IN., Red/White, White TD/Alley Lights, White Flood, Amber SignalMaster, Hook mount.	\$3,540.00	\$1,819.04
336320	Federal Signal	INTG44J-F2HM	44 IN., Red/White, White TD/Alley Lights, White Flood, Amber SignalMaster, Serial Interface Module, Hook mount.	\$3,610.00	\$1,855.01
336320	Federal Signal	INTG44J-P1L	44 in., Red/Blue, White LED TD/Alley Lights, White LED Flood, Amber SignalMaster, Low Hook mount	\$3,540.00	\$1,819.04
336320	Federal Signal	INTG44J-P2L	44 in., Blue/Blue, White LED TD/Alley Lights, White LED Flood, Amber SignalMaster, Low Hook mount	\$3,540.00	\$1,819.04
336320	Federal Signal	INTG44S-AMBR2	Integrity 44", Amber, SignalMaster, Front Flood, 6 button controller included	\$3,702.00	\$1,902.29
336320	Federal Signal	INTG44S-AMBR3	Integrity 44", Amber, SignalMaster, Front and Rear Flood, 6 button controller inc.	\$3,902.00	\$2,005.06
336320	Federal Signal	INTG51J-F1H	51 IN., Red/White, White TD/Alley Lights, Amber SignalMaster, Hook mount.	\$3,640.00	\$1,870.43
336320	Federal Signal	INTG51J-F1HM	51 IN., Red/White, White TD/Alley Lights, Amber SignalMaster, Serial Interface Module, Hook mount.	\$3,710.00	\$1,906.40
336320	Federal Signal	INTG51J-F2H	51 IN., Red/White, White TD/Alley Lights, White Flood, Amber SignalMaster, Hook mount.	\$3,890.00	\$1,998.89
336320	Federal Signal	INTG51J-F2HM	51 IN., Red/White, White TD/Alley Lights, White Flood, Amber SignalMaster, Serial Interface Module, Hook mount.	\$3,960.00	\$2,034.86
336320	Federal Signal	INTG51J-P1L	51 in., Red/Blue, White LED TD/Alley Lights, White LED Flood, Amber SignalMaster, Low Hook mount	\$3,890.00	\$1,998.89
336320	Federal Signal	INTG51J-P2L	51 in., Blue/Blue, White LED TD/Alley Lights, White LED Flood, Amber SignalMaster, Low Hook mount	\$3,890.00	\$1,998.89
336320	Federal Signal	INTG51S-AMBR2	Integrity 51", Amber, SignalMaster, Front Flood, 6 button controller included	\$4,052.00	\$2,082.14
336320	Federal Signal	INTG51S-AMBR30	Integrity Low-Profile LED Light Bar	\$4,214.00	\$2,165.38

336320	Federal Signal	INTG51S-AMBR31	Integrity Low-Profile LED Light Bar	\$4,432.00	\$2,277.40
336320	Federal Signal	INTG51S-AMBR3S	Integrity Light Bar, 51" with 6-button controller, (14) Amber/White, (12) Amber, SignalMaster, front flood feature, hook mount.	\$4,252.00	\$2,184.91
336320	Federal Signal	IPX300-2	IPX3 IMPAXX clear lens, Amber, (3) LEDs	\$148.00	\$76.05
336320	Federal Signal	IPX300-3	LED IMPAXX Blue	\$148.00	\$76.05
336320	Federal Signal	IPX300-4	LED IMPAXX Red	\$148.00	\$76.05
336320	Federal Signal	IPX302-2	IPX3 IMPAXX colored lens, Amber, (3) LEDs	\$153.00	\$78.62
336320	Federal Signal	IPX302-4	IPX3 IMPAXX colored lens, Red, (3) LEDs	\$153.00	\$78.62
336320	Federal Signal	IPX302-4DEU	IMPAXX W/DEUTSCH	\$153.00	\$78.62
336320	Federal Signal	IPX600B-A	IMPAXX600B,AMB,HOR,CLR	\$204.00	\$104.83
336320	Federal Signal	IPX600B-B	IMPAXX600B,BLU,HOR,CLR	\$204.00	\$104.83
336320	Federal Signal	IPX600B-G	IMPAXX, Single color, 6 LED light head, Green LED, Clear Lens	\$275.00	\$141.31
336320	Federal Signal	IPX600B-R	IMPAXX600B,RED,HOR,CLR	\$204.00	\$104.83
336320	Federal Signal	IPX600B-W	IMPAXX600B,WHT,HOR,CLR	\$270.00	\$138.74
336320	Federal Signal	IPX602B-RW	IMPAXX 620B, Red/White, clear lens	\$200.00	\$102.77
336320	Federal Signal	IPX602B-WA	IMPAXX 620B, Blue/White/Amber, clear lens	\$200.00	\$102.77
336320	Federal Signal	IPX602B-WPL	IMPAXX, Wing Plow Light, Amber	\$275.00	\$141.31
336320	Federal Signal	IPX620B-BR	IMPAXX620B,B/R,HOR,CLR	\$226.00	\$116.13
336320	Federal Signal	IPX620B-BW	IMPAXX620B,B/W,HOR,CLR	\$226.00	\$116.13
336320	Federal Signal	IPX620B-GR	IMPAXX620B,G/R,HOR,CLR	\$235.00	\$120.76
336320	Federal Signal	IPX620B-RA	IMPAXX620B,R/A,HOR,CLR	\$200.00	\$102.77
336320	Federal Signal	IPX620B-RW	IMPAXX620B,R/W,HOR,CLR	\$226.00	\$116.13
336320	Federal Signal	IPX620B-WA	IMPAXX620B,W/A,HOR,CLR	\$226.00	\$116.13
336320	Federal Signal	IPX630B-BRA	IMPAXX630B,B/R/A,HOR,CLR	\$270.00	\$138.74
336320	Federal Signal	IPX630B-BRW	IMPAXX630B,B/R/W,HOR,CLR	\$270.00	\$138.74
336320	Federal Signal	IPX630B-BWA	IMPAXX 630B, White/Amber, clear lens	\$269.00	\$138.23
336320	Federal Signal	IPX633B-BRW	IMPAXX633B,B/R/W,VER,CLR	\$275.00	\$141.31
336320	Federal Signal	IPX6M-1	IPX6 IMPAXX Chrome bezel	\$26.00	\$13.36
336320	Federal Signal	IPX-GRL1	IPX3/IPX6/VPX8, grille brackets, vertical mount	\$33.00	\$16.96
336320	Federal Signal	IPX-GRL10	Bracket Kit, IPX,MPS, Grille, FPIU16	\$40.00	\$20.55
336320	Federal Signal	IPX-GRL11	Bracket Kit, IPX,MPS, Grille, 15 F150	\$74.00	\$38.03
336320	Federal Signal	IPX-GRL12	IPX MOUNTING KIT	\$40.00	\$20.55
336320	Federal Signal	IPX-GRL13	IPX3/IPX6/MPS3/MPS6/MPS12, Grill bracket with hardware, horizontal mount, Chevy Traverse 2016-2017.	\$40.00	\$20.55
336320	Federal Signal	IPX-GRL14	Bracket Kit, Frill, 18 F-150 PPV, ND	\$50.00	\$25.69
336320	Federal Signal	IPX-GRL16	Single, no drill, grille bracket with hardware, horizontal mount orientation. Each bracket holds (2) MPS3U/MPS6U/IPX6B/MPS3/MPS6 lights, Ford Police Interceptor Utility 2020.	\$40.00	\$20.55
336320	Federal Signal	IPX-GRL17	Pair of lower grille brackets with hardware, horizontal mount orientation, each bracket holds (2) MPS3U/MPS6U lights, Ford Police Interceptor, 2020.	\$80.00	\$41.11
336320	Federal Signal	IPX-GRL2	IPX3/IPX6/VPX8, grille brackets, horizontal mount	\$33.00	\$16.96
336320	Federal Signal	IPX-GRL4	KIT,IPX GRILL MNT,CAP11	\$33.00	\$16.96
336320	Federal Signal	IPX-GRL5	IPX3/IPX6/VPX8/MPS300/MPS600, pair of grille brackets with hardware, 2013 Ford Police Interceptor Sedan	\$35.00	\$17.98
336320	Federal Signal	IPX-GRL6	KIT,GRILLE MNT,UTILITY	\$40.00	\$20.55
336320	Federal Signal	IPX-GRL7	KIT,GRILL MNT,TAH15,IPX3,IPX6,	\$45.00	\$23.12
336320	Federal Signal	IPX-GRL8	BRKT KIT,IPX-MPS,GRILLE,CHGR15	\$51.00	\$26.21
336320	Federal Signal	IPX-GRL9	BRKT KIT,IPX-MPS,GRILLE,W/RUMB	\$33.00	\$16.96
336320	Federal Signal	IPX-LPF1	IPX3 only, generic low side license plate holder	\$39.00	\$20.04
336320	Federal Signal	IPX-LPH1	IPX3/IPX6/VPX8, generic high side license plate holder	\$39.00	\$20.04
336320	Federal Signal	IPX-LPV1	IPX3/IPX6/VPX8, flat surface license plate mount	\$39.00	\$20.04
336320	Federal Signal	IPX-LPV2	Adjustable license plate mounting kit to mount (2) IPX3, IPX6, MPS3, MPS6, or MPS12 lighthoods.	\$74.00	\$38.03
336320	Federal Signal	IPX-LPVX1	IPX3/IPX6/VPX8, extended license plate bracket	\$42.00	\$21.58
336320	Federal Signal	IPXM6B-SPACRKT	Mounting wedges (4) IPX6	\$28.00	\$14.39
336320	Federal Signal	IPXM6-SPACRKT	Mounting wedges (4) IPX6	\$28.00	\$14.39
336320	Federal Signal	IPX-PB45H	IPX3/IPX6/VPX8, 45-degree slanted push bumper mounts horizontal	\$39.00	\$20.04
336320	Federal Signal	IPX-PB45V	IPX3/IPX6/VPX8, 45-degree slanted push bumper mounts vertical	\$39.00	\$20.04
336320	Federal Signal	IPX-PBL1	IPX3/IPX6/VPX8, universal "L" bracket, horizontal	\$33.00	\$16.96
336320	Federal Signal	IPX-RDW2	IPX3/IPX6/VPX8, rear side window mount brackets and covers	\$75.00	\$38.54
336320	Federal Signal	IPX-ROW1	IPX3/IPX6, rear side "Opera" window mount brackets	\$26.00	\$13.36
336320	Federal Signal	IPX-RSW1	IPX3/IPX6/VPX8, rear side window mount brackets and covers	\$75.00	\$38.54
336320	Federal Signal	IPX-RSW2	IPX3/IPX6/VPX8, rear side window mount brackets and covers	\$72.00	\$37.00

336320	Federal Signal	IPX-RSW4	Bracket Kit, IPX,MPS, Grille, 16 FPIU Cargo	\$90.00	\$46.25
336320	Federal Signal	IPX-TRNK4	IPX3/IPX6/MPS300/MPS600 - Pair of inner trunk lid brackets with hardware, For Ford Police Interceptor Sedan.	\$39.00	\$20.04
336320	Federal Signal	JMMK	KIT,MAGNETIC MOUNTING	\$132.00	\$67.83
336320	Federal Signal	JMPK	Kit, permanent mount, 21" Mini-JetSolaris	\$94.00	\$48.30
336320	Federal Signal	JNHK	Kit, hook mount brackets, Jet	\$97.00	\$49.84
336320	Federal Signal	LEDTCL64A-A	LED TCL Traffic Clearing Lights, 6X4 (pair), Color lens, Amber	\$560.00	\$287.76
336320	Federal Signal	LEDTCL64C-A	LED TCL Traffic Clearing Lights, 6X4 (pair), Clear lens, Amber	\$560.00	\$287.76
336320	Federal Signal	LEDTCL64C-B	LED TCL Traffic Clearing Lights, 6X4 (pair), Clear lens, Blue	\$560.00	\$287.76
336320	Federal Signal	LEDTCL64C-G	LED TCL Traffic Clearing Lights, 6X4 (pair), Clear lens, Green	\$560.00	\$287.76
336320	Federal Signal	LEDTCL64C-R	LED TCL Traffic Clearing Lights, 6X4 (pair), Clear lens, Red	\$560.00	\$287.76
336320	Federal Signal	LEDTCL64C-W	LED TCL, White, 6X4	\$560.00	\$287.76
336320	Federal Signal	LEDTCL64R-R	LED TCL Traffic Clearing Lights, 6X4 (pair), Color lens, Red	\$560.00	\$287.76
336320	Federal Signal	LEDTCL97A-A	LED TCL Traffic Clearing Lights, 9X7 (pair), Color lens, Amber	\$440.00	\$226.10
336320	Federal Signal	LEDTCL97C-A	LED TCL Traffic Clearing Lights, 9X7 (pair), Clear lens, Amber	\$440.00	\$226.10
336320	Federal Signal	LEDTCL97C-B	LED TCL Traffic Clearing Lights, 9X7 (pair), Clear lens, Blue	\$440.00	\$226.10
336320	Federal Signal	LEDTCL97C-G	LED TCL Traffic Clearing Lights, 9X7 (pair), Clear lens, Green	\$440.00	\$226.10
336320	Federal Signal	LEDTCL97C-R	LED TCL Traffic Clearing Lights, 9X7 (pair), Clear lens, Red	\$440.00	\$226.10
336320	Federal Signal	LEDTCL97C-W	9X7 Quad, LED TCL, White, Clear lens	\$440.00	\$226.10
336320	Federal Signal	LEDTCL97R-R	LED TCL Traffic Clearing Lights, 9X7 (pair), Color lens, Red	\$440.00	\$226.10
336320	Federal Signal	LF12ER	Littlite 12", Rheostat control	\$86.50	\$44.45
336320	Federal Signal	LF12ERB	Littlite 12", Rheostat control, wired base	\$86.50	\$44.45
336320	Federal Signal	LF12ESB	Littlite 12", On/Off switch control, wired base	\$86.50	\$44.45
336320	Federal Signal	LF12ES-LED	Littlite 12", On/Off switch control	\$130.00	\$66.80
336320	Federal Signal	LF12TR	Littlite 12" Rheostat control	\$86.50	\$44.45
336320	Federal Signal	LF12TRB	Littlite 12", Rheostat control, wired base	\$86.50	\$44.45
336320	Federal Signal	LF12TSB-LED	Littlite 12", On/Off switch control, wired base	\$130.00	\$66.80
336320	Federal Signal	LF12TS-LED	Littlite 12", On/Off switch control	\$130.00	\$66.80
336320	Federal Signal	LF18ERB	Littlite 18", Rheostat control, wired base	\$86.50	\$44.45
336320	Federal Signal	LF18ER-LED-UV	Littlite UV LED. 18", Rheostat control, UV/White/Red light modes, Neck extends from end of chassis, vertical mount	\$155.00	\$79.65
336320	Federal Signal	LF18ES-LED	Littlite 18", On/Off switch control	\$130.00	\$66.80
336320	Federal Signal	LF18TR	Littlite 18", Rheostat control	\$86.50	\$44.45
336320	Federal Signal	LF18TRB	Littlite 18", Rheostat control, wired base	\$86.50	\$44.45
336320	Federal Signal	LF18TS	Littlite 18", On/Off switch control	\$86.50	\$44.45
336320	Federal Signal	LF18TSB-LED	Littlite 18", On/Off switch control, wired base	\$130.00	\$66.80
336320	Federal Signal	LF18TSB-LED-BLUE	LITTLITE 18"ON/OFF SWITCH CON	\$130.00	\$66.80
336320	Federal Signal	LF18TS-LED	Littlite 18", On/Off switch control	\$130.00	\$66.80
336320	Federal Signal	LF6MOTO	Littlite 6", Switch control, wired base, motorcycle application	\$86.50	\$44.45
336320	Federal Signal	LFCHP	LittLite 12" End cable	\$79.00	\$40.59
336320	Federal Signal	LGD12Z-00001	(10) Amber LED heads, Clear domes, built in flasher, set.	\$1,066.00	\$547.77
336320	Federal Signal	LGD12Z-00002	(10) Amber LED heads, Clear domes, set.	\$1,006.00	\$516.94
336320	Federal Signal	LGD45Z-AMBR1H6	Legend Light Bar, 45", (18) Amber, clear domes, hook mount, 6-button controller	\$2,386.00	\$1,226.06
336320	Federal Signal	LGD45Z-AMBR2H6	Legend Light Bar, 45", (14) Amber, (2) LED takedowns, (2) alleys, clear domes, hook mount, 6-button controller	\$2,386.00	\$1,226.06
336320	Federal Signal	LGD53Z-AMBR1H6	Legend Light Bar, 53", (22) Amber, clear domes, hook mount, 6-button controller	\$2,581.00	\$1,326.26
336320	Federal Signal	LGD53Z-AMBR2H6	Legend Light Bar, 53", (18) Amber, (2) LED takedowns, (2) alleys, clear domes, hook mount, 6-button controller	\$2,581.00	\$1,326.26
336320	Federal Signal	LGD61Z-00004	61" MODELS, FLAT MOUNT AND 6-BUTTON CONTROLLER INCLUDED, CLEAR/CLEAR/CLEAR/CLEAR,, 4 AMBER CORNER LED REFLECTORS, 8 AMBER 5' LED REFLECTORS, 8 AMBER 4" REFLECTORS, 2 AMBER 2" LED REFLECTORS, 2 LED S/T/T LIGHTS, 2 LED WORK LIGHTS	\$2,766.00	\$1,421.32
336320	Federal Signal	LGD61Z-AMBR1F6	61 in., (26) Amber LED heads, clear dome, 6 button controller	\$2,766.00	\$1,421.32
336320	Federal Signal	LGD70Z-00004	70" MODELS, FLAT MOUNT AND 6-BUTTON CONTROLLER INCLUDED, CLEAR/CLEAR/CLEAR/CLEAR/CLEAR,, 4 AMBER CORNER LED REFLECTORS, 8 AMBER 5' LED REFLECTORS, 12 AMBER 4" REFLECTORS, 2 AMBER 2" LED REFLECTORS, 2 LED S/T/T LIGHTS, 2 LED WORK LIGHTS, 6 BUTTON CONTROLLER FLAT MOUNT	\$2,951.00	\$1,516.38
336320	Federal Signal	LGD70Z-AMBR1F6	Legend Light Bar, 70", (30) Amber, clear domes, flat mount, 6-button controller	\$2,951.00	\$1,516.38
336320	Federal Signal	LP800-A	LP800 Solaris Series Beacon	\$473.00	\$243.05
336320	Federal Signal	LP800-B	LP800 Solaris Series Beacon	\$473.00	\$243.05
336320	Federal Signal	LP800-BASE	LP800, Din Mount	\$104.00	\$53.44
336320	Federal Signal	LP800C-A	LP800 LED Beacon, Class 1, Clear dome, Amber LEDs	\$473.00	\$243.05
336320	Federal Signal	LP800C-B	LP800 LED Beacon, Class 1, Clear dome, Blue LEDs	\$473.00	\$243.05

336320	Federal Signal	LP800C-BASE	LP800 LED Beacon, Din Mount	\$99.00	\$50.87
336320	Federal Signal	LP800C-R	LP800 LED Beacon, Class 1, Clear dome, Red LEDs	\$473.00	\$243.05
336320	Federal Signal	LP800-R	LP800 Solaris Series Beacon	\$473.00	\$243.05
336320	Federal Signal	LPX45D-AMBR1H	Legend LPX Discrete Light Bar: 45", All Amber, Hook Mount, Clear Domes	\$2,047.00	\$908.17
336320	Federal Signal	LPX53D-00021	53 in., (18) Amber LED heads, (2) LED work lights, (2) external power S/T/T lights, clear domes	\$2,104.00	\$1,081.15
336320	Federal Signal	LPX53D-AMBR2H	Legend LPX Discrete Light Bar: 53", Amber, Takedowns, Alley lights, Hook Mount, Clear Domes.	\$2,104.00	\$1,081.15
336320	Federal Signal	LPX53H	53 in., (10/12) Amber LED heads, (2) LED external power S/T/T lights, (2) LED work lights, Gray domes	\$1,690.00	\$868.41
336320	Federal Signal	LPX61D-00017S	61 in., (22) Amber LED heads, (2) LED work lights, (2) external power S/T/T lights, clear domes	\$2,139.00	\$1,099.13
336320	Federal Signal	LPX61DS-00005S	61" MODELS, TRADITIONAL CABLE, FLAT MOUNT, 22 AMBER LED HEADS, 2 LED WORK LIGHTS, 2 LED S/T/T LIGHTS, CLEAR DOMES, WEATHER PACK CONNECTOR	\$2,139.00	\$1,099.13
336320	Federal Signal	LPX61H	61 in., (10/12) Amber LED heads, (2) LED external power S/T/T lights, (2) LED work lights, Gray domes	\$1,742.00	\$895.13
336320	Federal Signal	LPX70D-00003	70" MODELS, TRADITIONAL CABLE, FLAT MOUNT, 22 AMBER LED HEADS, 2 LED WORK LIGHTS, 2 LED S/T/T LIGHTS, CLEAR DOMES.	\$2,303.00	\$1,183.41
336320	Federal Signal	MB1	Public Safety messaging system with LED message display and controller	\$2,995.00	\$1,538.99
336320	Federal Signal	MB1-A	MB! LED Message Board, Amber LED message display and controller	\$2,995.00	\$1,538.99
336320	Federal Signal	MB1-BNRW	Message Board, Standard, Stand Alone, Narrow	\$2,995.00	\$1,538.99
336320	Federal Signal	MB1-G	LED Message Board, Public safety messaging system with Green LED message display and controller, 12VDC	\$2,995.00	\$1,538.99
336320	Federal Signal	MPS1200-BA	MICROPULSE, SURFACE MOUNT	\$169.00	\$86.84
336320	Federal Signal	MPS1200-BB	MICROPULSE, SURFACE MOUNT	\$169.00	\$86.84
336320	Federal Signal	MPS1200-RA	MICROPULSE, SURFACE MOUNT	\$169.00	\$86.84
336320	Federal Signal	MPS1200-RB	MICROPULSE, SURFACE MOUNT	\$169.00	\$86.84
336320	Federal Signal	MPS1200-RR	MICROPULSE, SURFACE MOUNT	\$169.00	\$86.84
336320	Federal Signal	MPS1200-RW	MICROPULSE, SURFACE MOUNT	\$169.00	\$86.84
336320	Federal Signal	MPS1200-WA	MICROPULSE, SURFACE MOUNT	\$169.00	\$86.84
336320	Federal Signal	MPS1202-AA	MicroPulse Ultra 12, Single color, Color lens, surface mount, 12 LED Amber	\$179.00	\$91.98
336320	Federal Signal	MPS1202-BB	MicroPulse Ultra 12, Single color, Color lens, surface mount, 12 LED Blue	\$179.00	\$91.98
336320	Federal Signal	MPS1202-GG	MicroPulse Ultra 12, Single color, Color lens, surface mount, 12 LED Green.	\$183.00	\$94.04
336320	Federal Signal	MPS1202-RR	MicroPulse Ultra 12, Single color, Color lens, surface mount, 12 LED Red	\$179.00	\$91.98
336320	Federal Signal	MPS121U-A	Single Color, Clear lens, surface mount, 12/24 Vdc, 12 LEDs, Amber	\$169.00	\$86.84
336320	Federal Signal	MPS121U-R	Single Color, Clear lens, surface mount, 12/24 Vdc, 12 LEDs, Red	\$169.00	\$86.84
336320	Federal Signal	MPS1220UX-BW	MicroPulse Ultra, Dual	\$199.00	\$102.26
336320	Federal Signal	MPS1220UX-RB	MicroPulse Ultra Steady Burn, Dual Color, Surface mount, 12/24 VDC, 24 LED light head, Red/Blue, Clear lens.	\$199.00	\$102.26
336320	Federal Signal	MPS1220UX-RW	MicroPulse Ultra, Dual	\$199.00	\$102.26
336320	Federal Signal	MPS122U-AW	Dual Color, Clear lens, surface mount, 12/24 Vdc, 24 LEDs, Amber/White	\$199.00	\$102.26
336320	Federal Signal	MPS122U-BW	Dual Color, Clear lens, surface mount, 12/24 Vdc, 24 LEDs, Blue/White	\$199.00	\$102.26
336320	Federal Signal	MPS122U-RB	Dual Color, Clear lens, surface mount, 12/24 Vdc, 24 LEDs, Red/Blue	\$199.00	\$102.26
336320	Federal Signal	MPS122U-RW	Dual Color, Clear lens, surface mount, 12/24 Vdc, 24 LEDs, Red/White	\$199.00	\$102.26
336320	Federal Signal	MPS123U-AGW	Tri-Color, Clear lens, surface mount, 12/24 Vdc, 36 LEDs, Amber/Green/White	\$229.00	\$117.67
336320	Federal Signal	MPS123U-BAW	Tri-Color, Clear lens, surface mount, 12/24 Vdc, 36 LEDs, Blue/Amber/White	\$229.00	\$117.67
336320	Federal Signal	MPS123U-RAW	Tri-Color, Clear lens, surface mount, 12/24 Vdc, 36 LEDs, Red/Amber/White	\$229.00	\$117.67
336320	Federal Signal	MPS123U-RBW	Tri-Color, Clear lens, surface mount, 12/24 Vdc, 36 LEDs, Red/Blue/White	\$229.00	\$117.67
336320	Federal Signal	MPS300-A	MICRO PULSE,SURFACE MNT,	\$109.00	\$56.01
336320	Federal Signal	MPS300-B	MICRO PULSE SURFACE MNT,	\$109.00	\$56.01
336320	Federal Signal	MPS300-W	MICRO PULSE,SURFACE MNT,	\$109.00	\$56.01



336320	Federal Signal	MPS31U-A	Single Color, Clear lens, surface mount, 12/24 Vdc, 3 LEDs, Amber	\$103.00	\$52.93
336320	Federal Signal	MPS31U-B	Single Color, Clear lens, surface mount, 12/24 Vdc, 3 LEDs, Blue	\$103.00	\$52.93
336320	Federal Signal	MPS31U-R	Single Color, Clear lens, surface mount, 12/24 Vdc, 3 LEDs, Red	\$103.00	\$52.93
336320	Federal Signal	MPS31U-W	Single Color, Clear lens, surface mount, 12/24 Vdc, 3 LEDs, White	\$103.00	\$52.93
336320	Federal Signal	MPS32U-AG	Dual Color, Clear lens, surface mount, 12/24 Vdc, 6 LEDs, Amber/Green	\$125.00	\$64.23
336320	Federal Signal	MPS32U-AW	Dual Color, Clear lens, surface mount, 12/24 Vdc, 6 LEDs, Amber/White	\$125.00	\$64.23
336320	Federal Signal	MPS32U-BA	Dual Color, Clear lens, surface mount, 12/24 Vdc, 6 LEDs, Blue/Amber	\$125.00	\$64.23
336320	Federal Signal	MPS32U-BW	Dual Color, Clear lens, surface mount, 12/24 Vdc, 6 LEDs, Blue/White	\$125.00	\$64.23
336320	Federal Signal	MPS32U-RA	Dual Color, Clear lens, surface mount, 12/24 Vdc, 6 LEDs, Red/Amber	\$125.00	\$64.23
336320	Federal Signal	MPS32U-RB	Dual Color, Clear lens, surface mount, 12/24 Vdc, 6 LEDs, Red/Blue	\$125.00	\$64.23
336320	Federal Signal	MPS32U-RW	Dual Color, Clear lens, surface mount, 12/24 Vdc, 6 LEDs, Red/White	\$125.00	\$64.23
336320	Federal Signal	MPS350-B	MicroPlus 3-LED hood/grille mount lighthouse, Blue	\$107.00	\$54.98
336320	Federal Signal	MPS350-R	MicroPlus 3-LED hood/grille mount lighthouse, Red	\$107.00	\$54.98
336320	Federal Signal	MPS350-W	MicroPlus 3-LED lighthouse, White	\$100.00	\$51.39
336320	Federal Signal	MPS600-AA	MicroPlus 6-LED surface mount lighthouse, Amber/Amber	\$157.00	\$80.68
336320	Federal Signal	MPS600-BA	MICRO PULSE SURFACE MOUNT	\$157.00	\$80.68
336320	Federal Signal	MPS600-BB	MicroPlus 6-LED lighthouse, Blue/Blue	\$149.00	\$76.56
336320	Federal Signal	MPS600-RB	MicroPlus 6-LED surface mount lighthouse, Red/Blue	\$146.00	\$75.02
336320	Federal Signal	MPS600-RR	MicroPlus 6-LED lighthouse, Red/Red	\$157.00	\$80.68
336320	Federal Signal	MPS600-WW	MICROPULSE SURFACE MOUNT,	\$149.00	\$76.56
336320	Federal Signal	MPS61U-A	Single Color, Clear lens, surface mount, 12/24 Vdc, 6 LEDs, Amber	\$149.00	\$76.56
336320	Federal Signal	MPS61U-B	Single Color, Clear lens, surface mount, 12/24 Vdc, 6 LEDs, Blue	\$149.00	\$76.56
336320	Federal Signal	MPS61U-R	Single Color, Clear lens, surface mount, 12/24 Vdc, 6 LEDs, Red	\$149.00	\$76.56
336320	Federal Signal	MPS61U-W	Single Color, Clear lens, surface mount, 12/24 Vdc, 6 LEDs, White	\$149.00	\$76.56
336320	Federal Signal	MPS620U-8FT-BR	MicroPulse Ultra, Dual, 8 Ft	\$189.00	\$97.12
336320	Federal Signal	MPS620U-8FT-BW	MicroPulse Ultra, Dual, 8 Ft	\$189.00	\$97.12
336320	Federal Signal	MPS620U-8FT-RW	MicroPulse Ultra, Dual, 8 Ft	\$189.00	\$97.12
336320	Federal Signal	MPS620U-BA	MICROPULSE ULTRA, DUAL COLOR	\$169.00	\$86.84
336320	Federal Signal	MPS620UX-8FT-BR	MicroPulse Ultra X, Dual, 8 Ft	\$189.00	\$97.12
336320	Federal Signal	MPS620UX-8FT-BW	MicroPulse Ultra X, Dual, 8 Ft	\$189.00	\$97.12
336320	Federal Signal	MPS620UX-8FT-RW	MicroPulse Ultra X, Dual, 8 Ft	\$189.00	\$97.12
336320	Federal Signal	MPS620UX-BA	MicroPulse Ultra X, Dual Color	\$169.00	\$86.84
336320	Federal Signal	MPS620UX-BR	MicroPulse Ultra X, Dual Color	\$169.00	\$86.84
336320	Federal Signal	MPS620UX-BW	MicroPulse Ultra X, Dual Color	\$169.00	\$86.84
336320	Federal Signal	MPS620UX-RA	MicroPulse Ultra Steady Burn, Dual Color, Surface mount, 12/24 VDC, 12 LED light head, Red/Amber, Clear lens	\$169.00	\$86.84
336320	Federal Signal	MPS620UX-RW	MicroPulse Ultra X, Dual Color	\$169.00	\$86.84
336320	Federal Signal	MPS62U-AW	Dual Color, Clear lens, surface mount, 12/24 Vdc, 12 LEDs, Amber/White	\$169.00	\$86.84
336320	Federal Signal	MPS62U-BA	Dual Color, Clear lens, surface mount, 12/24 Vdc, 12 LEDs, Blue/Amber	\$169.00	\$86.84
336320	Federal Signal	MPS62U-BW	Dual Color, Clear lens, surface mount, 12/24 Vdc, 12 LEDs, Blue/White	\$169.00	\$86.84
336320	Federal Signal	MPS62U-RB	Dual Color, Clear lens, surface mount, 12/24 Vdc, 12 LEDs, Red/Blue	\$169.00	\$86.84
336320	Federal Signal	MPS62U-RW	Dual Color, Clear lens, surface mount, 12/24 Vdc, 12 LEDs, Red/White	\$169.00	\$86.84
336320	Federal Signal	MPS63U-AGW	Tri-Color, Clear lens, surface mount, 12/24 Vdc, 18 LEDs, Red/Blue/Amber	\$189.00	\$97.12
336320	Federal Signal	MPS63U-BAW	Tri-Color, Clear lens, surface mount, 12/24 Vdc, 18 LEDs, Red/Blue/Amber	\$189.00	\$97.12
336320	Federal Signal	MPS63U-RAW	Tri-Color, Clear lens, surface mount, 12/24 Vdc, 18 LEDs, Red/Blue/Amber	\$189.00	\$97.12
336320	Federal Signal	MPS63U-RBA	Tri-Color, Clear lens, surface mount, 12/24 Vdc, 18 LEDs, Red/Blue/Amber	\$189.00	\$97.12

336320	Federal Signal	MPS63U-RBW	Tri-Color, Clear lens, surface mount, 12/24 Vdc, 18 LEDs, Red/Blue/Amber	\$189.00	\$97.12
336320	Federal Signal	MPS650-AA	MicroPlus 6-LED hood/grille mount lighthouse, Amber/Amber	\$154.00	\$79.13
336320	Federal Signal	MPS650-AW	MICROPULSE HOOD MOUNT	\$154.00	\$79.13
336320	Federal Signal	MPS650-BA	MicroPlus 6-LED lighthouse, Blue/Amber	\$154.00	\$79.13
336320	Federal Signal	MPS650-BB	MicroPlus 6-LED lighthouse, Blue/Blue	\$154.00	\$79.13
336320	Federal Signal	MPS650-RR	MicroPlus 6-LED lighthouse, Red/Red	\$154.00	\$79.13
336320	Federal Signal	MPS650-RW	MicroPulse, Hood Mount	\$154.00	\$79.13
336320	Federal Signal	MPS650-WW	MicroPlus 6-LED lighthouse, White/White	\$154.00	\$79.13
336320	Federal Signal	MPS652-BA	MICROPULSE 652	\$175.00	\$89.92
336320	Federal Signal	MPS652-BR	MICROPULSE 652	\$175.00	\$89.92
336320	Federal Signal	MPS652-BW	MICROPULSE 652	\$175.00	\$89.92
336320	Federal Signal	MPS652-RA	MICROPULSE 652	\$175.00	\$89.92
336320	Federal Signal	MPS652-RW	MICROPULSE 652	\$175.00	\$89.92
336320	Federal Signal	MPS652-WA	MICROPULSE 652	\$175.00	\$89.92
336320	Federal Signal	MPS6U-FPIU20FOG	Pair of fog light brackets, each bracket holds (1) MPS3U/MPS6U light, Ford Police Interceptor Utility, 2020	\$80.00	\$41.11
336320	Federal Signal	MPSC2X-BW	(8) LEDs, Blue/White, Dual Color, clear lens, steady burn, surface and stud mount, 12Vdc	\$159.00	\$81.70
336320	Federal Signal	MPSC2X-RB	(8) LEDs, Red/Blue, Dual Color, clear lens, steady burn, surface and stud mount, 12Vdc	\$159.00	\$81.70
336320	Federal Signal	MPSC2X-RW	(8) LEDs, Red/White, Dual Color, clear lens, steady burn, surface and stud mount, 12Vdc	\$159.00	\$81.70
336320	Federal Signal	MPSC-A	MicroPulse C Series, 6-LED surface mount warning light, with stud mount - AMBER	\$151.00	\$77.59
336320	Federal Signal	MPSC-AW	Split color MicroPulse C Series, 6-LED surface mount warning light, with stud mount- AMBER/WHITE (3-LEDs of each color)	\$151.00	\$77.59
336320	Federal Signal	MPSC-B	MicroPulse C Series, 6-LED surface mount warning light, with stud mount - BLUE	\$151.00	\$77.59
336320	Federal Signal	MPSC-BA	Split color MicroPulse C Series, 6-LED surface mount warning light, with stud mount- Blue/Amber (3-LEDs of each color)	\$151.00	\$77.59
336320	Federal Signal	MPSC-BW	Split color MicroPulse C Series, 6-LED surface mount warning light, with stud mount- BLUE/WHITE (3-LEDs of each color)	\$151.00	\$77.59
336320	Federal Signal	MPSC-R	MicroPulse C Series, 6-LED surface mount warning light, with stud mount - RED	\$151.00	\$77.59
336320	Federal Signal	MPSC-RA	MicroPulse C Series, Split, Red/Amb	\$151.00	\$77.59
336320	Federal Signal	MPSC-RB	Split color MicroPulse C Series, 6-LED surface mount warning light, with stud mount- RED/BLUE (3-LEDs of each color)	\$151.00	\$77.59
336320	Federal Signal	MPSC-RW	Split color MicroPulse C Series, 6-LED surface mount warning light, with stud mount- RED/WHITE (3-LEDs of each color)	\$151.00	\$77.59
336320	Federal Signal	MPSC-W	MicroPulse C Series, 6-LED surface mount warning light, with stud mount - WHITE	\$151.00	\$77.59
336320	Federal Signal	MPSM12-BOOT	Boot, MS1200 Series	\$26.00	\$13.36
336320	Federal Signal	MPSM12-DL	MicroPulse 1200U - Generic L-bracket for 2 MPS 1200U side-by-side	\$20.00	\$10.28
336320	Federal Signal	MPSM12-DS	MicroPulse 1200U - Generic L-brack for 2 MPS1200U stacked	\$20.00	\$10.28
336320	Federal Signal	MPSM12-POL1	MicroPulse Kit, Fog light brackets, Polaris	\$62.00	\$31.86
336320	Federal Signal	MPSM12-SB	MicroPulse 1200U - Swivel mount bracket	\$26.00	\$13.36
336320	Federal Signal	MPSM12U-SPACRKT	MicroPulse 1200U, (4) 5 degree mounting wedges	\$30.00	\$15.42
336320	Federal Signal	MPSM3-BOOT	Boot, MPS300 Series	\$21.00	\$10.79
336320	Federal Signal	MPSM3-BOOTKIT	Boot Kit, 2 rubber boots, 2 Mtg plates	\$52.00	\$26.72
336320	Federal Signal	MPSM3-DL	Generic L-Bracket for (2) MPS300, side-by-side	\$20.00	\$10.28
336320	Federal Signal	MPSM3-DS	Generic L-Bracket for (2) MPS300, stacked	\$20.00	\$10.28
336320	Federal Signal	MPSM3-SB	Swivel Mount Bracket for (1) MPS300	\$26.00	\$13.36
336320	Federal Signal	MPSM3-SPACRKT	Kit, Wedge, MPS3	\$20.00	\$10.28
336320	Federal Signal	MPSM3U-SPACRKT	MicroPulse Ultra, 3-LED - (4) 5 degree rubber mounting wedges	\$24.00	\$12.33
336320	Federal Signal	MPSM650-SPACRKT	Kit of four 5 degree rubber mounting wedges for use with (2) MPS650 lights	\$28.00	\$14.39
336320	Federal Signal	MPSM6-BOOT	Rubber boot mount for (1) MPS600	\$26.00	\$13.36
336320	Federal Signal	MPSM6-BOOTKIT	(2) Rubber boot mounts, (2) mounting plates for (2) MPS600	\$57.00	\$29.29
336320	Federal Signal	MPSM6-DL	Generic L-Bracket for (2) MPS600, side-by-side	\$20.00	\$10.28
336320	Federal Signal	MPSM6-DS	Generic L-Bracket for (2) MPS600, stacked	\$20.00	\$10.28
336320	Federal Signal	MPSM6-DU15RS	MICROPULSE SPOILER BRACKET	\$99.00	\$50.87
336320	Federal Signal	MPSM6-FPIU20RS1	2020 Ford Interceptor Utility spoiler bracket kit (2) MPS600 lights or (2) MPS600U lights	\$170.00	\$87.36
336320	Federal Signal	MPSM6-FPIU20RS2	2020 Ford Interceptor Utility spoiler bracket kit (6) MPS600 lights or (6) MPS600U lights	\$170.00	\$87.36
336320	Federal Signal	MPSM6-FPIU20RS3	Rear spoiler bracket kit, each bracket holds (2) MPS6/MPS6U light on each side of spoiler, Ford Police Interceptor Utility, 2020.	\$170.00	\$87.36

336320	Federal Signal	MPSM6-FPIUR2	Mounting kit	\$99.00	\$50.87
336320	Federal Signal	MPSM6-FPIURS	Mounting kit	\$111.00	\$57.04
336320	Federal Signal	MPSM6-FPIURS2	KIT, BRKT,MPS6/MPS6U,6HD SPOIL	\$162.00	\$83.24
336320	Federal Signal	MPSM6-FRD15RB	(6) Running board brackets, (1) MPS6/MPS6U light, Ford F150, 2015-2019	\$96.00	\$49.33
336320	Federal Signal	MPSM6-GRL1	Pair of grille brackets, each bracket holds (1) MPS3U/MPS6U light, fits vehicles with a mesh grille.	\$33.00	\$16.96
336320	Federal Signal	MPSM6-LPV1	Vertical mount license plate brackets, each bracket holds (2) MPS6U lights on each side.	\$96.00	\$49.33
336320	Federal Signal	MPSM6-LPV2	Vertical, low mount license plate brackets, each bracket holds (2) MPS6U lights on each side.	\$96.00	\$49.33
336320	Federal Signal	MPSM6-SB	Swivel Mount Bracket for (1) MPS600	\$26.00	\$13.36
336320	Federal Signal	MPSM6-SPACRKT	Mounting wedges (4) MPS600	\$25.00	\$12.85
336320	Federal Signal	MPSM6-TA15RS	MicroPulse 600 bracket for 2015 Chevy Tahoe spoiler	\$104.00	\$53.44
336320	Federal Signal	MPSM6-TA21RS	Rear spoiler bracket kit, each bracket holds (3) MPS6U lights on each side of spoiler, Chevrolet Tahoe, 2021	\$199.00	\$102.26
336320	Federal Signal	MPSM6U-SPACRKT	MicroPulse Ultra (4) 5 degree spacer wedges	\$25.00	\$12.85
336320	Federal Signal	MPSMC-SPACRKT	Wedge kit, 5 degree, C-Series	\$25.00	\$12.85
336320	Federal Signal	MPSMW0-POL1	Kit, tailgate brackets, Polaris MPS	\$62.00	\$31.86
336320	Federal Signal	MPSMW6-SPACRKT	Kit of four 5 degree rubber mounting wedges for use with MPSW6 lights	\$25.00	\$12.85
336320	Federal Signal	MPSMW9-CHGR11MIR	Pair of side mirror brackets, each bracket holds (1) MPSW9 light, Dodge Charger, 2011-2019	\$55.00	\$28.26
336320	Federal Signal	MPSMW9-DUR15MIR	Pair of side mirror brackets for 2018 Dodge, 2016-2018 Dodge Ram.	\$35.00	\$17.98
336320	Federal Signal	MPSMW9-FPIU13MIR	MicroPulse Wide Angle Mirror Bracket	\$31.00	\$15.93
336320	Federal Signal	MPSMW9-FPIU20MIR	Pair of side mirror brackets, each bracket holds (1) MPSW9 light, Ford Police Interceptor Utility 2020	\$31.00	\$15.93
336320	Federal Signal	MPSMW9-FRD15MIR	Pair of side mirror brackets, each bracket holds (1) MPSW9 light, Ford F150, 2015-2019	\$31.00	\$15.93
336320	Federal Signal	MPSMW9-SIL19MIR	Pair of side mirror brackets, each bracket holds (1) MPSW9 light, Chevrolet Silverado, 2019-2020	\$35.00	\$17.98
336320	Federal Signal	MPSMW9-SPACRKT	4 5 DEGREE RUBBER MOUNTING WEDGES FOR THE USE WITH MPSW9	\$25.00	\$12.85
336320	Federal Signal	MPSMW9-TAH15MIR	Pair of side mirror brackets for 2015 Tahoe	\$35.00	\$17.98
336320	Federal Signal	MPSMW9-TAH21MIR	Side mirror mount, MicroPulse Wide Angle 9, Chevrolet Tahoe, 2021	\$66.00	\$33.91
336320	Federal Signal	MPSSM23-A-30	23" MicroPulse SignalMaster, (4) Amber heads, 30 ft cable	\$750.00	\$385.39
336320	Federal Signal	MPSSM36-BRK-50	36 in., (6) Amber heads and (1) Red brake light (center), 50 ft cable	\$1,400.00	\$719.40
336320	Federal Signal	MPSSM42-A-30	42" MicroPulse SignalMaster, (6) Amber heads, 30 ft cable	\$1,400.00	\$719.40
336320	Federal Signal	MPSSM42-BRK-30	42" MicroPulse SignalMaster, (6) Amber heads and (1) Red brake light (center), 30 ft cable	\$1,550.00	\$796.47
336320	Federal Signal	MPSSM42-CAM-30	42" MicroPulse SignalMaster, (6) Amber heads and (1) Camera (center), 30 ft cable	\$1,699.00	\$873.04
336320	Federal Signal	MPSSM51-A-30	51" MicroPulse SignalMaster, (8) Amber heads, 30 ft cable	\$1,500.00	\$770.78
336320	Federal Signal	MPSSM51-BRK-30	51" MicroPulse SignalMaster, (8) Amber heads and (1) Red brake light (center), 30 ft cable	\$1,650.00	\$847.86
336320	Federal Signal	MPSUMA12-1	MicroPulse Angled Bezel, 40 degree angled bezel for (1) MPS12U light, Chrome	\$50.00	\$25.69
336320	Federal Signal	MPSUMA12-3	MicroPulse Angled Bezel, 40 degree angled bezel for (1) MPS12U light, Black	\$50.00	\$25.69
336320	Federal Signal	MPSUMO012-3	Black oval bezel for (1) MicroPulse Ultra 1200U	\$20.00	\$10.28
336320	Federal Signal	MPSUMO12-1	Chrome oval bezel for (1) MicroPulse Ultra 1200U	\$20.00	\$10.28
336320	Federal Signal	MPSU-PB45H	Pair of 45 degree slanted push bumper mounts with hardware, horizontal light orientation, each bracket holds (1) MPS3U/MPS6U/MPS12U light head, fits most push bumpers.	\$39.00	\$20.04
336320	Federal Signal	MPSU-PB45V	Pair of 45 degree slanted push bumper mounts with hardware, vertical light orientation, each bracket holds (1) MPS3U/MPS6U/MPS12U light head, fits most push bumpers.	\$39.00	\$20.04
336320	Federal Signal	MPSW6	MicroPulse Wide Angle, 6LED light head, single or split color, includes surface mount and side mirror mount.	\$191.00	\$98.15
336320	Federal Signal	MPSW6-A	MicroPulse Wide Angle, 6-LED surface mount warning light, with mirror mount - AMBER	\$191.00	\$98.15
336320	Federal Signal	MPSW6-AW	Split-color MicroPulse Wide Angle 6-LED surface mount warning light, with mirror mount - AMBER/WHITE (3-LEDs of each color)	\$191.00	\$98.15
336320	Federal Signal	MPSW6-B	MicroPulse Wide Angle, 6-LED surface mount warning light, with mirror mount - BLUE	\$191.00	\$98.15

336320	Federal Signal	MPSW6-BW	Split-color MicroPulse Wide Angle 6-LED surface mount warning light, with mirror mount - BLUE/WHITE (3-LEDs of each color)	\$191.00	\$98.15
336320	Federal Signal	MPSW6-R	MicroPulse Wide Angle, 6-LED surface mount warning light, with mirror mount - RED	\$191.00	\$98.15
336320	Federal Signal	MPSW6-RB	Split-color MicroPulse Wide Angle 6-LED surface mount warning light, with mirror mount - RED/BLUE (3-LEDs of each color)	\$191.00	\$98.15
336320	Federal Signal	MPSW6-RW	Split-color MicroPulse Wide Angle 6-LED surface mount warning light, with mirror mount - RED/WHITE (3-LEDs of each color)	\$191.00	\$98.15
336320	Federal Signal	MPSW6-W	MicroPulse Wide Angle, 6-LED surface mount warning light, with mirror mount - WHITE	\$191.00	\$98.15
336320	Federal Signal	MPSW9-A	MicroPulse Wide Angle -9 LED lighthouse, Amber	\$221.00	\$113.56
336320	Federal Signal	MPSW9-AG	MicroPulse Wide Angle 9, Dual color, clear lens, surface mount, 12-LED light head, (6) Amber, (6) Green.	\$231.00	\$118.70
336320	Federal Signal	MPSW9-AW	18-LED light head, Amber/White	\$231.00	\$118.70
336320	Federal Signal	MPSW9-B	MicroPulse Wide Angle -9 LED lighthouse, Blue	\$221.00	\$113.56
336320	Federal Signal	MPSW9-BA	18-LED light head, Blue/Amber	\$231.00	\$118.70
336320	Federal Signal	MPSW9-BW	18-LED light head, Blue/White	\$231.00	\$118.70
336320	Federal Signal	MPSW9-R	MicroPulse Wide Angle -9 LED lighthouse, Red	\$221.00	\$113.56
336320	Federal Signal	MPSW9-RA	18-LED light head, Red/Amber	\$231.00	\$118.70
336320	Federal Signal	MPSW9-RB	18-LED light head, Red/Blue	\$231.00	\$118.70
336320	Federal Signal	MPSW9-RW	18-LED light head, Red/White	\$231.00	\$118.70
336320	Federal Signal	MPSW9-W	MicroPulse Wide Angle -9 LED lighthouse, White	\$221.00	\$113.56
336320	Federal Signal	MPSW9X-BW	MicroPulse Wide Angle, Steady burn, Dual color, Surface mount, 12-LED light head, Blue/White	\$231.00	\$118.70
336320	Federal Signal	MPSW9X-RW	MicroPulse Wide Angle X, Red/White	\$231.00	\$118.70
336320	Federal Signal	MPSWPX-BW	MicroPulse Wide Angle X, Blue/White	\$231.00	\$118.70
336320	Federal Signal	MS4000	MS4000 Mini-Siren, 100W, Air Horn, Manual, Wail, Yelp, Priority intersection tone	\$402.50	\$206.83
336320	Federal Signal	MS4000U	MS4000 Undercover, 100W, Air Horn, Manual, Wail, Yelp, Priority intersection, remote	\$402.50	\$206.83
336320	Federal Signal	NE06	NS100W, 100W Driver, Six Pack	\$1,299.00	\$667.50
336320	Federal Signal	NVG10-3AF	Navigator Mini Light Bar, 10", flat mount, (3) Amber, built in flasher, clear dome.	\$907.00	\$466.07
336320	Federal Signal	NVG10-3AF-DOT	Navigator Mini Light Bar, 10", DOT System model, Requires DOT System Flasher (605010) ordered separately, (3) Amber modules, clear domes	\$907.00	\$466.07
336320	Federal Signal	NVG10-4ABF	Navigator Mini Light Bar, 10", flat mount, (4) Amber/Blue, built in flasher, clear dome.	\$1,247.00	\$640.78
336320	Federal Signal	NVG10-4AF	Navigator Mini Light Bar, 10", flat mount, (4) Amber, built in flasher, clear dome.	\$1,087.00	\$558.56
336320	Federal Signal	NVG10-4AF-DOT	Navigator Mini Light Bar, 10", DOT System model, Requires DOT System Flasher (605010) ordered separately, (4) Amber modules, clear domes	\$1,087.00	\$558.56
336320	Federal Signal	NVG10-4AGF	Navigator Mini Light Bar, 10", flat mount, (4) Amber/Green, built in flasher, clear dome.	\$1,367.00	\$702.44
336320	Federal Signal	NVG10-4AWF	Navigator Mini Light Bar, 10", flat mount, (4) Amber/White, built in flasher, clear dome.	\$1,247.00	\$640.78
336320	Federal Signal	NVG10-AAF	Navigator Mini Light Bar, 10" Rotator model, flat mount, (1) SLR Amber rotator, clear dome	\$667.00	\$342.74
336320	Federal Signal	NVG10-ABF	Navigator Mini Light Bar, 10" Rotator model, flat mount, (1) SLR Amber/Blue rotator, clear dome	\$742.00	\$381.28
336320	Federal Signal	NVG10-AGF	Navigator Mini Light Bar, 10" Rotator model, flat mount, (1) SLR Amber/Green rotator, clear dome	\$767.00	\$394.13
336320	Federal Signal	NVG10-AWF	Navigator Mini Light Bar, 10" Rotator model, flat mount, (1) SLR Amber/White rotator, clear dome	\$742.00	\$381.28
336320	Federal Signal	NVG10D-NFPA20	Navigator 10", Red LEDs, QuadraFlare Stationary Heads, Clear Dome	\$1,087.00	\$558.56
336320	Federal Signal	NVG10D-NFPA21-D	Navigator 10", Red LEDs, QuadraFlare Stationary Heads, Clear Dome	\$727.00	\$373.57
336320	Federal Signal	NVG10D-NFPA21-P	Navigator 10", Red LEDs, QuadraFlare Stationary Heads, Clear Dome	\$720.00	\$369.97
336320	Federal Signal	NVG10D-NFPA22-D	Navigator 10", Red LEDs, SLR Rotator, Clear Dome	\$717.00	\$368.43
336320	Federal Signal	NVG10D-NFPA22-P	Navigator 10", Red LEDs, SLR Rotator, Clear Dome	\$717.00	\$368.43
336320	Federal Signal	NVG18D-AMBR1FC	Navigator Mini Light Bar, 18", Stationary model - flat mount, (6) Amber, clear bulkheads, clear domes	\$1,651.00	\$848.37
336320	Federal Signal	NVG18D-AMBR1RFC	Navigator Mini Light Bar, 18", Rotator model, flat mount, (2) Amber rotators with mirror, clear bulkheads, clear domes.	\$1,171.00	\$601.72
336320	Federal Signal	NVG18D-MUN11RFC	Navigator Mini Light Bar, 18", Rotator model, flat mount, (2) Amber/white rotators with mirror, clear bulkheads, clear domes.	\$1,321.00	\$678.80

336320	Federal Signal	NVG18D-NFPA20-D	Navigator 18", Red/White LEDs, QuadraFlare Stationary Heads, Clear Dome	\$1,191.00	\$612.00
336320	Federal Signal	NVG18D-NFPA20-P	Navigator 18", Red/White LEDs, QuadraFlare Stationary Heads, Clear Dome	\$1,191.00	\$612.00
336320	Federal Signal	NVG25D-AMBR1FC	Navigator Mini Light Bar, 25", Stationary model - flat mount, (8) Amber, clear bulkheads, clear domes	\$2,062.00	\$1,059.57
336320	Federal Signal	NVG25D-AMBR1RFB	Navigator Mini Light Bar, 25", Rotator model, flat mount, (2) Amber, (2) SLR Amber rotators with mirror, black bulkheads, amber domes.	\$1,682.00	\$864.30
336320	Federal Signal	NVG25D-AMBR1RFC	Navigator Mini Light Bar, 25", Rotator model, flat mount, (2) Amber, (2) SLR Amber rotators with mirror, clear bulkheads, clear domes.	\$1,682.00	\$864.30
336320	Federal Signal	NVG25D-MUNI2RFC	Navigator Mini Light Bar, 25", Rotator model, flat mount, (1) Amber, (1) work light, (2) SLR Amber rotators with mirror, clear bulkheads, clear domes.	\$1,682.00	\$864.30
336320	Federal Signal	NVG25D-NFPA20-D	Navigator 25", Red/White LEDs, QuadraFlare Stationary Heads, Clear Dome	\$1,382.00	\$710.15
336320	Federal Signal	NVG25D-NFPA20-P	Navigator 25", Red/White LEDs, QuadraFlare Stationary Heads, Clear Dome	\$1,382.00	\$710.15
336320	Federal Signal	NVG25D-NFPA21	Navigator 25", Red LEDs, QuadraFlare Stationary Heads, Clear Dome	\$1,522.00	\$782.09
336320	Federal Signal	NVG45Z-MUNI1HC6	Navigator Serial Light Bar, 45", (8) Amber, (6) Amber/White, front flood feature, alley feature, SignalMaster, hook mount, clear bulkheads, clear domes, 6-button controller.	\$4,070.00	\$2,091.39
336320	Federal Signal	NVG45Z-NFPA20	Navigator 45" Light Bar, Red/White, Clear Dome, QuadraFlare Stationary Heads, White LED Flood	\$4,020.00	\$2,065.69
336320	Federal Signal	NVG45Z-NFPA21	Navigator 45" Light Bar, Red/White, Clear Dome, QuadraFlare Stationary Heads, SLR Rotator, White LED Flood	\$3,632.00	\$1,866.32
336320	Federal Signal	NVG53D-MUNI1HC	Navigator Discrete, 53" (9) Amber, (7) Amber/White, front flood feature, alley feature, SignalMaster, hook mount, clear bulkheads, clear domes.	\$4,231.00	\$2,174.12
336320	Federal Signal	NVG53D-MUNIRHC	Navigator Discrete, 53" (5) Amber, (5) Amber/White, (2) SLR Amber/White rotators with mirror, front flood feature, alley feature, SignalMaster, hook mount, clear bulkheads, clear domes.	\$3,921.00	\$2,014.82
336320	Federal Signal	NVG53Z-MUNI1RHC6	Navigator Serial Light Bar, 53", (5) Amber, (5) Amber/White, (2) SLR Amber/White rotators with mirror, front flood feature, alley feature, SignalMaster, hook mount, clear bulkheads, clear domes, 6-button controller.	\$4,219.00	\$2,167.95
336320	Federal Signal	NVG53Z-NFPA20	Navigator 53" Light Bar, Red/White, Clear Dome, QuadraFlare Stationary Heads, White LED Flood	\$4,511.00	\$2,317.99
336320	Federal Signal	NVG53Z-NFPA21	Navigator 53" Light Bar, Red/White, Clear Dome, QuadraFlare Stationary Heads, SLR Rotator, White LED Flood	\$4,123.00	\$2,118.62
336320	Federal Signal	NVG60D-NFPA20	60", Red/White, QuadraFlare Stationary Heads, SLR Rotator, clear dome, Discrete.	\$2,661.00	\$1,367.37
336320	Federal Signal	NVG60D-NFPA21	60", Red/White, QuadraFlare Stationary Heads, clear dome, Discrete.	\$3,133.00	\$1,609.90
336320	Federal Signal	NVG60D-NFPA22	Navigator 53" Light Bar, Red/White, Clear Dome, QuadraFlare Stationary Heads, White LED Flood	\$3,573.00	\$1,836.00
336320	Federal Signal	NVG60D-TOW1FC	Navigator Discrete, 60" (14) Amber, (2) work lights, (2) S/T/T , flat mount, clear bulkheads, clear domes.	\$4,413.00	\$2,267.64
336320	Federal Signal	NVG60D-TOW2FC	Navigator Discrete, 60" (8) Amber, (2) SLR Amber rotators with mirror, (2) work lights, (2) S/T/T lights, flat mount, clear bulkheads, clear domes.	\$4,033.00	\$2,072.37
336320	Federal Signal	NVG60Z-TOW2FC6	Navigator Serial Light Bar, 60", (8) Amber, (2) SLR Amber/White rotators with mirror, (2) work lights, (2) S/T/T lights, flat mount, clear bulkheads, clear domes, 6-button controller.	\$4,331.00	\$2,225.50
336320	Federal Signal	NVG73D-AMBR1FC	Navigator Discrete, 73" (20) Amber, flat mount, clear bulkheads, clear domes.	\$4,875.00	\$2,505.04
336320	Federal Signal	NVG73D-NFPA20	Navigator 73" Light Bar, Red/White, Clear Dome, QuadraFlare Stationary Heads, White LED Flood	\$2,795.00	\$1,436.22
336320	Federal Signal	NVG73D-NFPA21	Navigator 73" Light Bar, Red/White, Clear Dome, QuadraFlare Stationary Heads, SLR Rotator, White LED Flood	\$3,549.00	\$1,823.67
336320	Federal Signal	NVG73D-NFPA22	Navigator 73" Light Bar, Red/White, Clear Dome, SLR Rotator, White LED Flood	\$3,531.00	\$1,814.42
336320	Federal Signal	NVG73D-NFPA23	Navigator 73" Light Bar, Red/White, Clear Dome, QuadraFlare Stationary Heads, White LED Flood	\$3,435.00	\$1,765.09
336320	Federal Signal	NVG73D-NFPA24	Navigator 73" Light Bar, Red/White, Clear Dome, QuadraFlare Stationary Heads, White LED Flood	\$3,595.00	\$1,847.30
336320	Federal Signal	NVG73D-TOW5FC	Navigator Light Bar, 73", 9!8) Amber modules, (2) external power S/T/T lights, flat mount, clear bulkheads, clear dome.	\$4,875.00	\$2,505.04

336320	Federal Signal	NVG87D-AMBR3RFC	87 in., (16) Amber modules, (3) SLR Amber rotators with mirror, clear bulkheads, clear domes	\$5,057.00	\$2,598.56
336320	Federal Signal	NVG87D-NFPA20	Navigator Light Bar, 87", Red/White, QuadraFlare stationary heads, Flood, clear done, Discrete	\$3,337.00	\$1,714.73
336320	Federal Signal	NVG87D-NFPA22	Navigator Light Bar, 87", Red/White, SLR Rotator, Flood, clear done, Discrete	\$3,357.00	\$1,725.01
336320	Federal Signal	OBDCABLE25	25-foot OBD interface cable	\$199.00	\$102.26
336320	Federal Signal	OBDCABLE25-1	25 ft OBDII interface cable, for use on 2018 Chevrolet Tahoe, 2018 Ford Police Interceptor Utility, 2018 Ford F-150, and 2018 Ford Interceptor Sedan.	\$199.00	\$102.26
336320	Federal Signal	OBDCABLE25-2	25" OBDII interface cable, for use on 2020 Ford Interceptor Utility	\$199.00	\$102.26
336320	Federal Signal	OBDCABLE25-3	25ft OBDII interface cable for use on 2020+ Ford Expedition, Escape, and F-250.	\$399.00	\$205.03
336320	Federal Signal	OBDCABLE25-DGCAN	25 ft OBDII interfae cable, for use on 2018 Dodge Charger Pursuit and 2018 Dodge Durango	\$199.00	\$102.26
336320	Federal Signal	OBDCABLE5	5-foot OBD interface cable	\$199.00	\$102.26
336320	Federal Signal	OBDCABLE6-1	6 ft OBDII interface cable, for use on 2018 Chevrolet Tahoe, 2018 Ford Police Interceptor Utility, 2018 Ford F-150, and 2018 Ford Interceptor Sedan.	\$199.00	\$102.26
336320	Federal Signal	OBDCABLE6-2	6" OBDII interface cable, for use on 2020 Ford Interceptor Utility	\$199.00	\$102.26
336320	Federal Signal	OBDCABLE6-3	6ft OBDII interface cable for use on 2020+ Ford Expedition, Escape, and F-250.	\$199.00	\$102.26
336320	Federal Signal	OBDCABLE6-DGCAN	6 ft OBDII interface cable, for use on 2018 Dodge Charger Pursuit and 2018 Dodge Durango.	\$199.00	\$102.26
336320	Federal Signal	PA4000	PA4000 200W, flush mount control, remote amplifier	\$705.00	\$362.27
336320	Federal Signal	PF100	Pathfinder, 100W, Self Contained	\$1,099.00	\$564.73
336320	Federal Signal	PF100H	Pathfinder, 100W, Hand held	\$1,299.00	\$667.50
336320	Federal Signal	PF200	PathFinder 100/200 watt siren/light controller with self-contained controls, OBD integration capability, integrated Rumbler capability, and integrated dual-tone capability, with PA and noise-canceling microphone.	\$1,150.00	\$590.93
336320	Federal Signal	PF200AMP	Pathfinder Siren, 100/200W, Amp only	\$1,150.00	\$590.93
336320	Federal Signal	PF200H	Pathfinder Siren/Light Controller with handheld controller, 100/200 W, OBDII integration capability, integrated Rumbler capability, and integrated dual tone capability.	\$1,350.00	\$693.70
336320	Federal Signal	PF200R	Pathfinder Siren/Light Controller with remote surface mount controller, 100/200 W, OBDII integration capability, integrated Rumbler capability, and integrated dual tone capability.	\$1,350.00	\$693.70
336320	Federal Signal	PF200S17	Pathfinder Siren/Light Controller with 17 button controller, 100/200 W, OBDII Integration capability, integrated Rumbler capability, and integrated dual tone capability	\$1,899.00	\$975.81
336320	Federal Signal	PF200S17B	Pathfinder B Series Controller	\$1,899.00	\$975.81
336320	Federal Signal	PF200S4	Pathfinder, 100/200W, 4 Button	\$1,225.00	\$629.47
336320	Federal Signal	PF200S6	Pathfinder, 100/200W, 6 Button	\$1,275.00	\$655.16
336320	Federal Signal	PPPDM-1	Power Distribution Module, Pathfinder Siren.100 Amp Max Load.	\$499.00	\$256.41
336320	Federal Signal	PLPR1	Perimeter Light Programmer	\$75.00	\$38.54
336320	Federal Signal	Q2B-012NNSD	Q2B, mechanical siren, chrome, recess mount	\$2,348.00	\$1,206.53
336320	Federal Signal	Q2B-012PSD	Q2B, mechanical siren, chrome, pedestal mount	\$2,616.00	\$1,344.24
336320	Federal Signal	Q2FSK	Kit, Q2B, foot switch	\$52.00	\$26.72
336320	Federal Signal	QL43-AA	QuadraFlare 4X3, single color, Color lens, built in flasher, Amber LEDs, Amber lens.	\$196.00	\$100.72
336320	Federal Signal	QL43-BACKUP	QuadraFlare 4X3, Back-up light, White LEDs, Clear lens	\$175.00	\$89.92
336320	Federal Signal	QL43-BB	QuadraFlare 4X3, single color, Color lens, built in flasher, Flue LEDs, blue lens.	\$196.00	\$100.72
336320	Federal Signal	QL43-BTT	QuadraFlare 4X3, Brake/Tail/Turn, Red LEDs, Red lens	\$175.00	\$89.92
336320	Federal Signal	QL43C-AA	QuadraFlare 4X3, single color, Clear lens, built in flasher, Amber LEDs	\$196.00	\$100.72
336320	Federal Signal	QL43C-AW	QuadraFlare 4X3, Split color, Clear lens, built in flasher, Amber/White LEDs	\$196.00	\$100.72
336320	Federal Signal	QL43C-BA	QuadraFlare 4X3, Split color, Clear lens, built in flasher, Blue/Amber LEDs	\$196.00	\$100.72
336320	Federal Signal	QL43C-BB	QuadraFlare 4X3, single color, Clear lens, built in flasher, Blue LEDs	\$196.00	\$100.72
336320	Federal Signal	QL43C-BW	QuadraFlare 4X3, Split color, Clear lens, built in flasher, Blue/White LEDs	\$196.00	\$100.72
336320	Federal Signal	QL43C-GG	QuadraFlare 4X3, single color, Clear lens, built in flasher, Green LEDs	\$196.00	\$100.72
336320	Federal Signal	QL43C-RA	QuadraFlare 4X3, Split color, Clear lens, built in flasher, Red/Amber LEDs	\$196.00	\$100.72

336320	Federal Signal	QL43C-RB	QuadraFlare 4X3, Split color, Clear lens, built in flasher, Red/Blue LEDs	\$196.00	\$100.72
336320	Federal Signal	QL43C-RG	QuadraFlare, Flashing Red/Green, Split Color	\$196.00	\$100.72
336320	Federal Signal	QL43C-RR	QuadraFlare 4X3, single color, Clear lens, built in flasher, Red LEDs	\$196.00	\$100.72
336320	Federal Signal	QL43C-RW	QuadraFlare 4X3, Split color, Clear lens, built in flasher, Red/White LEDs	\$196.00	\$100.72
336320	Federal Signal	QL43C-WW	QuadraFlare 4X3, single color, Clear lens, built in flasher, White LEDs	\$196.00	\$100.72
336320	Federal Signal	QL43D-A	QuadraFlare 4X3 DOT, Single color, Color DOT lens, weather tight connector, Amber LEDs, Amber lens	\$175.00	\$89.92
336320	Federal Signal	QL43D-B	QuadraFlare 4X3 DOT, Single color, Color DOT lens, weather tight connector, Blue LEDs, Blue lens	\$175.00	\$89.92
336320	Federal Signal	QL43D-BACKUP	QuadraFlare 4X3, DOT, Back-up light, White LED, Clear lens	\$175.00	\$89.92
336320	Federal Signal	QL43D-BTT	QuadraFlare 4X3, DOT, Brake/Tail/Turn, Red LED, Red lens.	\$175.00	\$89.92
336320	Federal Signal	QL43DD-AB	QuadraFlare 4X3 DOT, Dual color, Clear DOT lens, weather tight connector, Amber/Blue	\$196.00	\$100.72
336320	Federal Signal	QL43DD-AG	QuadraFlare 4X3 DOT, Dual color, Clear DOT lens, weather tight connector, Amber/Green	\$196.00	\$100.72
336320	Federal Signal	QL43DD-AW	QuadraFlare 4X3 DOT, Dual color, Clear DOT lens, weather tight connector, Amber/White	\$196.00	\$100.72
336320	Federal Signal	QL43DD-RA	QuadraFlare 4X3 DOT, Dual color, Clear DOT lens, weather tight connector, Red/Amber	\$196.00	\$100.72
336320	Federal Signal	QL43D-G	QuadraFlare 4X3 DOT, Single color, Color DOT lens, weather tight connector, Green LEDs, Green lens	\$175.00	\$89.92
336320	Federal Signal	QL43D-R	QuadraFlare 4X3 DOT, Single color, Color DOT lens, weather tight connector, Red LEDs, Red lens	\$175.00	\$89.92
336320	Federal Signal	QL43D-W	QuadraFlare 4X3 DOT, Single color, Color DOT lens, weather tight connector, White LEDs, White lens	\$175.00	\$89.92
336320	Federal Signal	QL43-GG	QuadraFlare 4X3, single color, Color lens, built in flasher, Green LEDs, Green lens.	\$196.00	\$100.72
336320	Federal Signal	QL43MC	Trim Ring w/Gasket, 4X3, Lt	\$23.00	\$11.82
336320	Federal Signal	QL43-RR	QuadraFlare 4X3, single color, Color lens, built in flasher, Red LEDs, Red lens.	\$196.00	\$100.72
336320	Federal Signal	QL43-TURN	QuadraFlare 4X3, Turn light, Amber LEDs, Amber lens	\$175.00	\$89.92
336320	Federal Signal	QL43Z-AA	QuadraFlare 4X3 DOT, Single color, Color lens, weather tight connector, Amber LEDs, Amber lens	\$175.00	\$89.92
336320	Federal Signal	QL43Z-BB	QuadraFlare 4X3 DOT, Single color, Color lens, weather tight connector, Blue LEDs, Blue lens	\$175.00	\$89.92
336320	Federal Signal	QL43ZD-AB	QuadraFlare 4X3 DOT, Dual color, Color lens, weather tight connector, Amber/Blue	\$185.00	\$95.06
336320	Federal Signal	QL43ZD-AG	QuadraFlare 4X3 DOT, Dual color, Color lens, weather tight connector, Amber/Green	\$196.00	\$100.72
336320	Federal Signal	QL43ZD-AW	QuadraFlare 4X3 DOT, Dual color, Color lens, weather tight connector, Amber/White	\$196.00	\$100.72
336320	Federal Signal	QL43ZD-RA	QuadraFlare 4X3 DOT, Dual color, Color lens, weather tight connector, Red/Amber	\$196.00	\$100.72
336320	Federal Signal	QL43Z-GG	QuadraFlare 4X3 DOT, Single color, Color lens, weather tight connector, Green LEDs, Green lens	\$175.00	\$89.92
336320	Federal Signal	QL43Z-RR	QuadraFlare 4X3 DOT, Single color, Color lens, weather tight connector, Red LEDs, Red lens	\$175.00	\$89.92
336320	Federal Signal	QL43Z-WW	QuadraFlare 4X3 DOT, Single color, Color lens, weather tight connector, White LEDs, White lens	\$175.00	\$89.92
336320	Federal Signal	QL64-24-AA	QuadraFlare, LED-24V, Amber	\$208.00	\$106.88
336320	Federal Signal	QL64-24-BB	QuadraFlare, LED-24V, Blue	\$208.00	\$106.88
336320	Federal Signal	QL64-24-GG	QuadraFlare, LED-24V, Green	\$208.00	\$106.88
336320	Federal Signal	QL64-24-RR	QuadraFlare, LED-24V, Red	\$208.00	\$106.88
336320	Federal Signal	QL64-24-WW	QuadraFlare, LED-24V, White	\$208.00	\$106.88
336320	Federal Signal	QL643H	QuadraFlare 6X4, 3-Position Horizontal Casting, Casting with gasket	\$208.00	\$106.88
336320	Federal Signal	QL643H-LEDLEFT	QuadraFlare 6X4, 3-Position Horizontal Casting, Installed QL64-BTT, QL64 Turn, QL64-Backup	\$809.00	\$415.71
336320	Federal Signal	QL643H-LEDRIGHT	QuadraFlare 6X4, 3-Position Horizontal Casting, Installed QL64-BTT, QL64 Turn, QL64-Backup	\$809.00	\$415.71
336320	Federal Signal	QL643H-LEFT	QuadraFlare 6X4, 3-Position Horizontal Casting, Installed QL64-BTT, QL64 Arrow (left facing), QL64-Backup	\$735.00	\$377.68
336320	Federal Signal	QL643H-RIGHT	QuadraFlare 6X4, 3-Position Horizontal Casting, Installed QL64-BTT, QL64 Arrow (right facing), QL64-Backup	\$735.00	\$377.68
336320	Federal Signal	QL643V	QuadraFlare 6X4, 3-Position Vertical Casting, Casting with gasket	\$208.00	\$106.88
336320	Federal Signal	QL643V-LED	QuadraFlare 6X4, Installed QL64-BTT, QL64 Turn, QL64 Backup	\$809.00	\$415.71

336320	Federal Signal	QL643V-LEFT	QuadraFlare 6X4, Installed QL64-BTT, QL64 Arrow (left facing), QL64 Backup	\$735.00	\$377.68
336320	Federal Signal	QL643V-RIGHT	QuadraFlare 6X4, Installed QL64-BTT, QL64 Arrow (right facing), QL64 Backup	\$735.00	\$377.68
336320	Federal Signal	QL643V-RS912	QuadraFlare, LED, 3-up vertical, Blue/Red/Green, Hallibur	\$952.00	\$489.19
336320	Federal Signal	QL644V	QuadraFlare 6X4, 4-Position Vertical Casting, Casting with gasket	\$272.00	\$139.77
336320	Federal Signal	QL644V-LED	QuadraFlare 6X4, 4-Position Vertical Casting, Installed QL64-BTT, QL64-Turn, QL64-Backup, QL64-RR	\$1,077.00	\$553.42
336320	Federal Signal	QL644V-LEFT	QuadraFlare 6X4, 4-Position Vertical Casting, Installed QL64-BTT, QL64-ARROW, (left facing), QL64-Backup, QL64-RR	\$995.00	\$511.28
336320	Federal Signal	QL644V-RIGHT	QuadraFlare 6X4, 4-Position Vertical Casting, Installed QL64-BTT, QL64-ARROW, (right facing), QL64-Backup, QL64-RR	\$995.00	\$511.28
336320	Federal Signal	QL64-AA	QuadraFlare LED - Color Lens	\$196.00	\$100.72
336320	Federal Signal	QL64-ARROW	TURN ARROW, AMBER LED, AMBER LENS	\$185.00	\$95.06
336320	Federal Signal	QL64-BACKUP	BACK UP LIGHT, WHITE LED, CLEAR LENS	\$223.00	\$114.59
336320	Federal Signal	QL64-BB	QuadraFlare LED - Color Lens	\$196.00	\$100.72
336320	Federal Signal	QL64-BTT	BTT, RED LED, RED LENS	\$190.00	\$97.63
336320	Federal Signal	QL64C-AA	QuadraFlare LED - Clear Lens	\$196.00	\$100.72
336320	Federal Signal	QL64C-AG	QuadraFlare 6X4, Split color, Amber/Green LED, Clear Lens	\$196.00	\$100.72
336320	Federal Signal	QL64C-AW	QuadraFlare LED - Clear Lens	\$196.00	\$100.72
336320	Federal Signal	QL64C-BA	QuadraFlare LED - Clear Lens	\$196.00	\$100.72
336320	Federal Signal	QL64C-BB	QuadraFlare LED - Clear Lens	\$196.00	\$100.72
336320	Federal Signal	QL64C-BW	QuadraFlare LED - Clear Lens	\$196.00	\$100.72
336320	Federal Signal	QL64C-GG	QuadraFlare 6X4, Single color, Green LED, Clear Lens	\$196.00	\$100.72
336320	Federal Signal	QL64C-RA	QuadraFlare LED - Clear Lens	\$196.00	\$100.72
336320	Federal Signal	QL64C-RB	QuadraFlare LED - Clear Lens	\$196.00	\$100.72
336320	Federal Signal	QL64C-RG	QuadraFlare 6X4, Split color, Red/Green LED, Clear Lens	\$219.00	\$112.53
336320	Federal Signal	QL64C-RR	QuadraFlare LED - Clear Lens	\$196.00	\$100.72
336320	Federal Signal	QL64C-RW	QuadraFlare LED - Clear Lens	\$196.00	\$100.72
336320	Federal Signal	QL64C-WW	QuadraFlare LED - Clear Lens	\$196.00	\$100.72
336320	Federal Signal	QL64-GG	QuadraFlare 6X4, Single color, Green LED, Green Lens	\$196.00	\$100.72
336320	Federal Signal	QL64MHL	6x4 QuadraFlare Headlight mount kit	\$52.00	\$26.72
336320	Federal Signal	QL64-RR	FLASHING RED, RED LENS,	\$196.00	\$100.72
336320	Federal Signal	QL64-RRDEU	QL64, Red w/Deutch Conn.	\$196.00	\$100.72
336320	Federal Signal	QL64-TURN	TURN LIGHT, AMBER LED, AMBER LENS	\$190.00	\$97.63
336320	Federal Signal	QL73-AA	QuadraFlare 7X3 LED - Color lens and built-in flasher	\$196.00	\$100.72
336320	Federal Signal	QL73-ARROW	QuadraFlare, Arrow, Amber	\$185.00	\$95.06
336320	Federal Signal	QL73-BACKUP	QuadraFlare, Backup Light	\$223.00	\$114.59
336320	Federal Signal	QL73-BB	QuadraFlare 7X3 LED - Color lens and built-in flasher	\$196.00	\$100.72
336320	Federal Signal	QL73-BTT	QuadraFlare, Brake/Turn/Tail	\$190.00	\$97.63
336320	Federal Signal	QL73C-AA	QuadraFlare 7X3 LED - Clear lens and built-in flasher	\$196.00	\$100.72
336320	Federal Signal	QL73C-AW	QuadraFlare 7X3 LED - Split-Color with Clear lens and built-in flasher	\$274.00	\$140.80
336320	Federal Signal	QL73C-BA	QuadraFlare 7X3 LED - Split-Color with Clear lens and built-in flasher	\$242.00	\$124.35
336320	Federal Signal	QL73C-BB	QuadraFlare 7X3 LED - Clear lens and built-in flasher	\$196.00	\$100.72
336320	Federal Signal	QL73C-BTT	QuadraFlare, Brake/Turn/Tail	\$190.00	\$97.63
336320	Federal Signal	QL73C-BW	QuadraFlare 7X3 LED - Split-Color with Clear lens and built-in flasher	\$274.00	\$140.80
336320	Federal Signal	QL73C-GG	QuadraFlare 7X3 LED - Clear lens and built-in flasher	\$248.00	\$127.44
336320	Federal Signal	QL73C-RA	QuadraFlare 7X3 LED - Split-Color with Clear lens and built-in flasher	\$242.00	\$124.35
336320	Federal Signal	QL73C-RB	QuadraFlare 7X3 LED - Split-Color with Clear lens and built-in flasher	\$242.00	\$124.35
336320	Federal Signal	QL73C-RG	QuadraFlare 7X3 LED - Split-Color with Clear lens and built-in flasher	\$274.00	\$140.80
336320	Federal Signal	QL73C-RR	QuadraFlare 7X3 LED - Clear lens and built-in flasher	\$196.00	\$100.72
336320	Federal Signal	QL73C-RW	QuadraFlare 7X3 LED - Split-Color with Clear lens and built-in flasher	\$274.00	\$140.80
336320	Federal Signal	QL73C-WW	QuadraFlare 7X3 LED - Clear lens and built-in flasher	\$236.00	\$121.27
336320	Federal Signal	QL73D-A	QuadraFlare 7X3 DOT, Single color, Color DOT lens, weather tight connector, Amber LEDs, Amber lens.	\$175.00	\$89.92
336320	Federal Signal	QL73D-B	QuadraFlare 7X3 DOT, Single color, Color DOT lens, weather tight connector, Blue LEDs, Blue lens.	\$175.00	\$89.92
336320	Federal Signal	QL73D-BACKUP	QuadraFlare 7X3 DOT, Back-up light, White LEDs, Clear lens.	\$175.00	\$89.92
336320	Federal Signal	QL73D-BTT	QuadraFlare 7X3 DOT, Brake/Tail/Turn, Red LEDs, Red lens.	\$175.00	\$89.92
336320	Federal Signal	QL73DD-AB	QuadraFlare 7X3 DOT, Dual color, Clear DOT lens, weather tight connector, Amber/Blue	\$196.00	\$100.72



336320	Federal Signal	QL73DD-AG	QuadraFlare 7X3 DOT, Dual color, Clear DOT lens, weather tight connector, Amber/Green	\$196.00	\$100.72
336320	Federal Signal	QL73DD-AW	QuadraFlare 7X3 DOT, Dual color, Clear DOT lens, weather tight connector, Amber/White	\$196.00	\$100.72
336320	Federal Signal	QL73DD-RA	QuadraFlare 7X3 DOT, Dual color, Clear DOT lens, weather tight connector, Red/Amber.	\$196.00	\$100.72
336320	Federal Signal	QL73D-G	QuadraFlare 7X3 DOT, Single color, Color DOT lens, weather tight connector, Green LEDs, Green lens.	\$175.00	\$89.92
336320	Federal Signal	QL73D-R	QuadraFlare 7X3 DOT, Single color, Color DOT lens, weather tight connector, Red LEDs, Red lens.	\$175.00	\$89.92
336320	Federal Signal	QL73D-W	QuadraFlare 7X3 DOT, Single color, Color DOT lens, weather tight connector, White LEDs, White lens.	\$175.00	\$89.92
336320	Federal Signal	QL73-GG	QuadraFlare 7X3 LED - Color lens and built-in flasher	\$248.00	\$127.44
336320	Federal Signal	QL73-LB	BRACKET KIT, QL73-LB	\$196.00	\$100.72
336320	Federal Signal	QL73LEDSCENE	7X3 LED Scene Light	\$213.00	\$109.45
336320	Federal Signal	QL73-RR	QuadraFlare 7X3 LED - Color lens and built-in flasher	\$196.00	\$100.72
336320	Federal Signal	QL97-AA	QuadraFlare 9X7, Single color, Color lens, Built-in flasher, Amber LEDs, Amber lens	\$325.00	\$167.00
336320	Federal Signal	QL97-ARROW	QuadraFlare 9X7, Arrow, Amber LEDs, Amber lens	\$336.00	\$172.65
336320	Federal Signal	QL97-BACKUP	QuadraFlare 9X7, Back-up, White LEDs, Clear lens	\$336.00	\$172.65
336320	Federal Signal	QL97-BB	QuadraFlare 9X7, Single color, Color lens, Built-in flasher, Blue LEDs, Blue lens	\$325.00	\$167.00
336320	Federal Signal	QL97-BTT	QuadraFlare 9X7, Brake/Tail/Turn, Red LEDs, Red lens	\$336.00	\$172.65
336320	Federal Signal	QL97C-AA	QuadraFlare 9X7, Single color, Clear lens, Built-in flasher, Amber	\$325.00	\$167.00
336320	Federal Signal	QL97C-ARROW	QuadraFlare, Arrow, Smooth	\$336.00	\$172.65
336320	Federal Signal	QL97C-AW	QuadraFlare 9X7, Split color, Clear lens, Built-in flasher, Amber/White	\$374.00	\$192.18
336320	Federal Signal	QL97C-BA	QuadraFlare 9X7, Split color, Clear lens, Built-in flasher, Blue/Amber	\$325.00	\$167.00
336320	Federal Signal	QL97C-BB	QuadraFlare 9X7, Single color, Clear lens, Built-in flasher, Blue	\$325.00	\$167.00
336320	Federal Signal	QL97C-BTT	QuadraFlare, BTT, Clear, Filtered Lens	\$336.00	\$172.65
336320	Federal Signal	QL97C-BW	QuadraFlare 9X7, Split color, Clear lens, Built-in flasher, Blue/White	\$366.00	\$188.07
336320	Federal Signal	QL97C-GG	QuadraFlare 9X7, Single color, Clear lens, Built-in flasher, Green	\$374.00	\$192.18
336320	Federal Signal	QL97C-RA	QuadraFlare 9X7, Split color, Clear lens, Built-in flasher, Red/Amber	\$325.00	\$167.00
336320	Federal Signal	QL97C-RB	QuadraFlare 9X7, Split color, Clear lens, Built-in flasher, Red/Blue	\$325.00	\$167.00
336320	Federal Signal	QL97C-RG	QuadraFlare 9X7, Split color, Clear lens, Built-in flasher, Red/Green	\$374.00	\$192.18
336320	Federal Signal	QL97C-RR	QuadraFlare 9X7, Single color, Clear lens, Built-in flasher, Red	\$325.00	\$167.00
336320	Federal Signal	QL97C-RW	QuadraFlare 9X7, Split color, Clear lens, Built-in flasher, Red/White	\$374.00	\$192.18
336320	Federal Signal	QL97C-WW	QuadraFlare 9X7, Single color, Clear lens, Built-in flasher, White	\$374.00	\$192.18
336320	Federal Signal	QL97-GG	QuadraFlare 9X7, Single color, Color lens, Built-in flasher, Green LEDs, Green lens	\$325.00	\$167.00
336320	Federal Signal	QL97LEDSCENE	Scene light, 9x7, LED, surface mount	\$449.00	\$230.72
336320	Federal Signal	QL97LEDSCENE-D	LED SCENE,9X7,QUAD,W/DEU	\$459.00	\$235.86
336320	Federal Signal	QL97-RR	QuadraFlare 9X7, Single color, Color lens, Built-in flasher, Red LEDs, Red lens.	\$325.00	\$167.00
336320	Federal Signal	QL97SF-AA	QuadraFlare Amber/Amber - color lens	\$297.00	\$152.61
336320	Federal Signal	QL97SFC-AA	QuadraFlare Amber/Amber - clear lens	\$297.00	\$152.61
336320	Federal Signal	QL97SFC-AC	QuadraFlare Amber/White - clear lens	\$343.00	\$176.25
336320	Federal Signal	QL97SFC-BA	QUADRAFLARE SPLIT BLU/AMB	\$297.00	\$152.61
336320	Federal Signal	QL97SFC-BB	QuadraFlare Blue/Blue - clear lens	\$297.00	\$152.61
336320	Federal Signal	QL97SFC-BC	QuadraFlare Blue/Clear - clear lens	\$335.00	\$172.14
336320	Federal Signal	QL97SFC-CC	QuadraFlare White/White - clear lens	\$343.00	\$176.25
336320	Federal Signal	QL97SFC-RA	QuadraFlare Red/Amber - clear lens	\$297.00	\$152.61
336320	Federal Signal	QL97SFC-RB	QuadraFlare Red/Blue - clear lens	\$297.00	\$152.61
336320	Federal Signal	QL97SFC-RC	QuadraFlare Red/White - clear lens	\$343.00	\$176.25
336320	Federal Signal	QL97SFC-RR	QuadraFlare Red/Red - clear lens	\$297.00	\$152.61
336320	Federal Signal	QL97SF-GG	QuadraFlare Green/Green - color lens	\$382.00	\$196.29
336320	Federal Signal	QL97SF-RR	QuadraFlare Red/Red - color lens	\$297.00	\$152.61
336320	Federal Signal	QL97-TURN	QuadraFlare 9X7, Turn, Amber LEDs, Amber lens	\$336.00	\$172.65
336320	Federal Signal	QL97XF-A	QuadraFlare Amber - color lens	\$297.00	\$152.61
336320	Federal Signal	QL97XF-B	QuadraFlare Blue - color lens	\$297.00	\$152.61
336320	Federal Signal	QL97XFC-A	QuadraFlare Amber - clear lens	\$297.00	\$152.61
336320	Federal Signal	QL97XFC-B	QuadraFlare Blue - clear lens	\$297.00	\$152.61

336320	Federal Signal	QL97XFC-C	QuadraFlare White - clear lens	\$343.00	\$176.25
336320	Federal Signal	QL97XFC-R	QuadraFlare Red - clear lens	\$297.00	\$152.61
336320	Federal Signal	QL97XF-G	QuadraFlare Green - color lens	\$382.00	\$196.29
336320	Federal Signal	QL97XF-R	QuadraFlare Red - color lens	\$297.00	\$152.61
336320	Federal Signal	QL97Z-ARROW	9X7 ARROW	\$308.00	\$158.27
336320	Federal Signal	QL97Z-BACKUP	9X7 BACKUP	\$308.00	\$158.27
336320	Federal Signal	QL97Z-BTT	9X7 BRAKE/TAI/TURN	\$308.00	\$158.27
336320	Federal Signal	QL97Z-TURN	9X7 TURN	\$308.00	\$158.27
336320	Federal Signal	Q-MT	Kit, Q2B, bracket for recess mounting Q2B siren	\$196.00	\$100.72
336320	Federal Signal	RB-CAP11	Rumbler Kit, pair of mount brackets with hardware for 2011 Chevrolet Caprice	\$175.00	\$89.92
336320	Federal Signal	RB-CGR11	Rumbler Kit, pair of mount brackets with hardware for 2011 Dodge Charger police package vehicles	\$60.00	\$30.83
336320	Federal Signal	RB-CHG15	Bracket Kit, Rumbler Charger 15	\$54.80	\$28.16
336320	Federal Signal	RB-CHGR15	Kit, pair of mount brackets with hardware for Dodge Charger police package vehicles, 2015-2018.	\$50.00	\$25.69
336320	Federal Signal	RB-CVIC05	Rumbler Kit, pair of mount brackets with hardware for Ford Crown Victoria police package vehicles	\$60.00	\$30.83
336320	Federal Signal	RB-DG4500HD	Bracket Kit, Rumbler, Ram HD, 2010-2012	\$70.00	\$35.97
336320	Federal Signal	RB-DUR15	Bracket Kit, Rumbler, Durango 2015	\$65.75	\$33.79
336320	Federal Signal	RB-DUR19	Rumbler bracket, 2019-2020 Dodge Durango	\$54.80	\$28.16
336320	Federal Signal	RB-ES08	Rumbler Kit, pair of mount brackets with hardware for 2008 Ford E-Series Chassis	\$70.00	\$35.97
336320	Federal Signal	RB-EXP08	Rumbler Kit, pair of mount brackets with hardware for 2008 and newer Ford Expedition vehicles	\$60.00	\$30.83
336320	Federal Signal	RB-FHD08	Rumbler Kit, pair of mount brackets with hardware for 2008 and newer Ford F-250 Super Duty vehicles	\$70.00	\$35.97
336320	Federal Signal	RB-FHD11	Bracket Kit, Rumbler, 11F-Superduty	\$79.00	\$40.59
336320	Federal Signal	RB-FHD17	Rumbler-3 Siren Bracket Kit	\$70.00	\$35.97
336320	Federal Signal	RB-FPIU13	Rumbler Kit, pair of mount brackets with hardware for 2013 Ford Police Interceptor Utility	\$70.00	\$35.97
336320	Federal Signal	RB-FPIU16	Rumbler mount bracket kit	\$60.00	\$30.83
336320	Federal Signal	RB-FPIU20	Kit, pair of Rumbler mount brackets with hardware, Ford Police Interceptor Utility 2020	\$54.80	\$28.16
336320	Federal Signal	RB-FRD15	Kit, pair of rumbler mount brackets with hardware, Ford F150 2015-2019, not including Ecoboost.	\$54.80	\$28.16
336320	Federal Signal	RB-FRD15E	Kit, pair of rumbler mount brackets with hardware, Ford F150 2015-2019, including Ecoboost.	\$54.80	\$28.16
336320	Federal Signal	RB-GVAN11	Rumbler kit, GVAN 11	\$70.00	\$35.97
336320	Federal Signal	RB-IMP08	Rumbler Kit, pair of mount brackets, hardware 2008 newer Impala	\$70.00	\$35.97
336320	Federal Signal	RBKIT1	Single Rumbler Woofer, vehicle specific Rumbler brackets sold separately.	\$299.00	\$153.64
336320	Federal Signal	RBKIT2	Pair of Rumbler Woofers, vehicle specific Rumbler brackets sold separately.	\$499.00	\$256.41
336320	Federal Signal	RB-RAM16	Rumbler kit, 16 Ram	\$54.80	\$28.16
336320	Federal Signal	RB-SIL17	Rumbler bracket kit, pair with mount brackets with hardware for Chevrolet Silverado SSV 2015-2017.	\$60.00	\$30.83
336320	Federal Signal	RB-SILGD20	Bracket kit, Rumbler, 2020 Silverado HD, no-drill	\$60.00	\$30.83
336320	Federal Signal	RB-SPRNTR	Rumbler kit, Sprinter	\$65.75	\$33.79
336320	Federal Signal	RB-SW	Rumbler Actuation Switch Kit	\$55.00	\$28.26
336320	Federal Signal	RB-TAH15	Rumbler Mount Kit - 2015 Tahoe	\$54.80	\$28.16
336320	Federal Signal	RB-TAH008	Rumbler Kit, pair of mount brackets with hardware for 2008 and newer Chevrolet Tahoe/Suburban vehicles	\$70.00	\$35.97
336320	Federal Signal	RB-U	Rumbler Kit, Mount Brackets	\$54.80	\$28.16
336320	Federal Signal	RLNT48-F2LR	48 In., Red, White LED TD and Alley Lights, White Flood, Amber SignalMaster, Red Brake Light, Low Hook mount.	\$1,900.00	\$976.32
336320	Federal Signal	RLNT48-F3LR	48 In., Red, White LED TD and Alley Lights, White Flood, Amber SignalMaster, Red Brake Light, Low Hook mount.	\$1,900.00	\$976.32
336320	Federal Signal	RLNT48-P1LRB	48 in., Red/Blue, positions 2,9 White LED TD, White LED Alley, White LED Flood, Amber SignalMaster, Red LED Brake Lights, Low Hook mount	\$1,900.00	\$976.32
336320	Federal Signal	RLNT48-P2LB	48 in., Blue, positions 2,9 White LED TD, White LED Alley, White LED Flood, Amber SignalMaster, Red LED Brake Lights, Low Hook mount	\$1,900.00	\$976.32
336320	Federal Signal	RLNT48-P3LRB	48 in., Red/Blue, positions 5,6 White LED TD, White LED Alley, White LED Flood, Amber SignalMaster, Red LED Brake Lights, Low Hook mount	\$1,900.00	\$976.32
336320	Federal Signal	RLNT48-P4LB	48 in., Blue, positions 5,6 White LED TD, White LED Alley, White LED Flood, Amber SignalMaster, Red LED Brake Lights, Low Hook mount	\$1,900.00	\$976.32

336320	Federal Signal	RLNT48Z-AMBR1H4	48 in., Amber warning lights, White TD and Alley Lights, White Flood, Amber SignalMaster	\$1,880.00	\$966.05
336320	Federal Signal	RLNT48Z-AMBR1P4	48 in., Amber warning lights, White TD and Alley Lights, White Flood, Amber SignalMaster	\$1,880.00	\$966.05
336320	Federal Signal	RLNT48Z-AMBR2H4	48 in., Amber warning lights, White TD and Alley Lights, White Flood, Amber SignalMaster	\$1,930.00	\$991.74
336320	Federal Signal	RMK	PF200R - Remote extension kit for 1/4 inch microphone	\$115.00	\$59.09
336320	Federal Signal	RUMBLER-3	Siren amp, Rumbler, secondary warning system, 12V, low frequency tones, hardware kit, housing bands and cradles	\$815.00	\$418.79
336320	Federal Signal	RUMBLER-3-PF	Siren Amp, Rumbler, secondary warning system, 12VDC, low frequency tones, hardware kit, housing bands and cradles. Used with PF200 to utilize dual tone and Rumbler capabilities.	\$699.00	\$359.18
336320	Federal Signal	SIFMJH-CHCR17-P3	Center Focused Style, Rear hatch/Rear deck, Dodge Charger, 2017+	\$1,600.00	\$822.17
336320	Federal Signal	SIFMJH-CHGR17-PF1	Center Focused Style, OBD Integrated Rear hatch/Rear deck, Dodge Charger, 2017+	\$1,775.00	\$912.09
336320	Federal Signal	SIFMJH-CHGR17-PF2	Center Focused Style, Rear hatch/Rear deck, Dodge Charger, 2017+	\$1,800.00	\$924.94
336320	Federal Signal	SIFMJH-DUR18-P3	Center Focused Style, Rear hatch/Rear deck, Dodge Durango, 2018+	\$1,600.00	\$822.17
336320	Federal Signal	SIFMJH-DUR18-PF1	Center Focused Style, OBD Integrated Rear hatch/Rear deck, Dodge Durango, 2018+	\$1,775.00	\$912.09
336320	Federal Signal	SIFMJH-DUR18-PF2	Center Focused Style, Rear hatch/Rear deck, Dodge Durango, 2018+	\$1,800.00	\$924.94
336320	Federal Signal	SIFMJH-FPIU20-P3	Center Focused Style, Rear hatch/Rear deck, Ford Police Interceptor Utility, 2020+	\$1,600.00	\$822.17
336320	Federal Signal	SIFMJH-FPIU20-PF1	Center Focused Style, OBD Integrated, Rear hatch/Rear deck, Ford Police Interceptor Utility, 2020+	\$1,775.00	\$912.09
336320	Federal Signal	SIFMJH-FPIU20-PF2	Center Focused Style, Rear hatch/Rear deck, Ford Police Interceptor Utility, 2020+	\$1,800.00	\$924.94
336320	Federal Signal	SIFMJH-TAH21-P3	Center Focused Style, Rear hatch/Rear deck, Chevrolet Tahoe, 2021	\$1,600.00	\$822.17
336320	Federal Signal	SIFMJH-TAH21-PF1	Center Focused Style, OBD Integrated Rear hatch/Rear deck, Chevrolet Tahoe, 2021	\$1,775.00	\$912.09
336320	Federal Signal	SIFMJH-TAH21-PF2	Center Focused Style, Rear hatch/Rear deck, Chevrolet Tahoe, 2021	\$1,800.00	\$924.94
336320	Federal Signal	SIFMJS-CHGR16-P3	Center Focused Style, Split Front, Dodge Charger, 2016+	\$1,800.00	\$924.94
336320	Federal Signal	SIFMJS-DUR15-P3	Center Focused Style, Split Front, Dodge Durango, 2016+	\$1,800.00	\$924.94
336320	Federal Signal	SIFMJS-FD15-P3	Center Focused Style, Split Front, Ford F-150, 2015+	\$1,800.00	\$924.94
336320	Federal Signal	SIFMJS-FPIU20-P3	Center Focused Style, Split Front, Ford Police Interceptor Utility, 2020+	\$1,800.00	\$924.94
336320	Federal Signal	SIFMJS-TAH21-P3	Center Focused Style, Split Front, Chevrolet Tahoe, 2021	\$1,800.00	\$924.94
336320	Federal Signal	SIFMS-AMBR1CS	SpectraLux ILS Low Profile SIFMS Center-Focused, Split Front Headliner, Chevy Tahoe/Silverado 2015+, Amber, discrete cable.	\$1,310.00	\$673.15
336320	Federal Signal	SIFMS-AMBR1FF	SpectraLux ILS Low Profile SIFMS Center-Focused, Split Front Headliner, Ford F150/250/350 2017+, Amber, discrete cable.	\$1,310.00	\$673.15
336320	Federal Signal	SIFMS-AMBR1FF6	SpectraLux ILS Low Profile SIFMS Center-Focused, Split Front Headliner, Ford F150/250/350 2017+, Amber, 6 button controller.	\$1,608.00	\$826.28
336320	Federal Signal	SIFMS-AMBR1MV	SpectraLux ILS Low Profile SIFMS Center-Focused, Split Front Headliner, Universal Mount, Amber, discrete cable.	\$1,310.00	\$673.15
336320	Federal Signal	SIFMS-AMBR1MV6	SpectraLux ILS Low Profile SIFMS Center-Focused, Split Front Headliner, Universal Mount, Amber, 6 button controller.	\$1,608.00	\$826.28
336320	Federal Signal	SIFMS-AMBR1SS6	Center-focused, Split Front Headliner, Amber, 6-button controller	\$1,608.00	\$826.28
336320	Federal Signal	SIFMS-AMBR2CS	SpectraLux ILS Low Profile SIFMS Center-Focused, Split Front Headliner, Chevy Tahoe/Silverado 2015+, Amber/White, discrete cable.	\$1,670.00	\$858.14
336320	Federal Signal	SIFMS-AMBR2FF	SpectraLux ILS Low Profile SIFMS Center-Focused, Split Front Headliner, Ford F150/250/350 2017+, Amber/White, discrete cable.	\$1,670.00	\$858.14
336320	Federal Signal	SIFMS-AMBR2FF6	SpectraLux ILS Low Profile SIFMS Center-Focused, Split Front Headliner, Ford F150/250/350 2017+, Amber/White, 6 button controller.	\$1,968.00	\$1,011.26
336320	Federal Signal	SIFMS-AMBR2MV	SpectraLux ILS Low Profile SIFMS Center-Focused, Split Front Headliner, Universal Mount, Amber/White, discrete cable.	\$1,670.00	\$858.14
336320	Federal Signal	SIFMS-AMBR2MV6	SpectraLux ILS Low Profile SIFMS Center-Focused, Split Front Headliner, Universal Mount, Amber/White, 6 button controller.	\$1,968.00	\$1,011.26
336320	Federal Signal	SIFMS-AMBR2SS6	Center-focused, Split Front Headliner, Amber/White, 6-button controller	\$1,968.00	\$1,011.26
336320	Federal Signal	SIFZJS-CHCR16-P3	Off Axis Style, Dodge Charger, 2016+	\$1,800.00	\$924.94

336320	Federal Signal	SIFZJS-FD15-P3	Off Axis Style, Ford F-150, 2015+	\$1,800.00	\$924.94
336320	Federal Signal	SIFZJS-FPIU20-P3	Off-Axis Style, Ford Police Interceptor Utility, 2020+	\$1,800.00	\$924.94
336320	Federal Signal	SIFZJS-TAH21-P3	Off Axis Style, Chevrolet Tahoe, 2021+	\$1,800.00	\$924.94
336320	Federal Signal	SIFZS-AMBR1CC	SpectraLux ILS Low Profile SIFZS Advanced Off-Axis, Split Front Headliner, Amber, Chevy Colorado 2016+, Amber, discrete cable.	\$1,310.00	\$673.15
336320	Federal Signal	SIFZS-AMBR1CC6	SpectraLux ILS Low Profile SIFZS Advanced Off-Axis, Split Front Headliner, Amber, Chevy Colorado 2016+, Amber, 6 button controller.	\$1,608.00	\$826.28
336320	Federal Signal	SIFZS-AMBR1DR	SpectraLux ILS Low Profile SIFZS Advanced Off-Axis, Split Front Headliner, Amber, Dodge Ram 2016+, Amber, discrete cable.	\$1,310.00	\$673.15
336320	Federal Signal	SIFZS-AMBR1DR6	SpectraLux ILS Low Profile SIFZS Advanced Off-Axis, Split Front Headliner, Amber, Dodge Ram 2016+, Amber, 6 button controller.	\$1,608.00	\$826.28
336320	Federal Signal	SIFZS-AMBR1MV	SpectraLux ILS Low Profile SIFZS Advanced Off-Axis, Split Front Headliner, Amber, Universal Mount, Amber, discrete cable.	\$1,310.00	\$673.15
336320	Federal Signal	SIFZS-AMBR1MV6	SpectraLux ILS Low Profile SIFZS Advanced Off-Axis, Split Front Headliner, Amber, Universal Mount, Amber, 6 button controller.	\$1,608.00	\$826.28
336320	Federal Signal	SIFZS-AMBR2CC	SpectraLux ILS Low Profile SIFZS Advanced Off-Axis, Split Front Headliner, Amber, Chevy Colorado 2016+, Amber/White, discrete cable.	\$1,670.00	\$858.14
336320	Federal Signal	SIFZS-AMBR2CC6	SpectraLux ILS Low Profile SIFZS Advanced Off-Axis, Split Front Headliner, Amber, Chevy Colorado 2016+, Amber/White, 6 button controller.	\$1,968.00	\$1,011.26
336320	Federal Signal	SIFZS-AMBR2DR	SpectraLux ILS Low Profile SIFZS Advanced Off-Axis, Split Front Headliner, Amber, Dodge Ram 2016+, Amber/White, discrete cable.	\$1,670.00	\$858.14
336320	Federal Signal	SIFZS-AMBR2DR6	SpectraLux ILS Low Profile SIFZS Advanced Off-Axis, Split Front Headliner, Amber, Dodge Ram 2016+, Amber/White, 6 button controller.	\$1,968.00	\$1,011.26
336320	Federal Signal	SIFZS-AMBR2MV	SpectraLux ILS Low Profile SIFZS Advanced Off-Axis, Split Front Headliner, Amber, Universal Mount, Amber/White, discrete cable.	\$1,670.00	\$858.14
336320	Federal Signal	SIFZS-AMBR2MV6	SpectraLux ILS Low Profile SIFZS Advanced Off-Axis, Split Front Headliner, Amber, Universal Mount, Amber/White, 6 button controller.	\$1,968.00	\$1,011.26
336320	Federal Signal	SL4F-2B2W	Latitude LED flashing warning light, 4 Head, alternating BWBW	\$350.00	\$179.85
336320	Federal Signal	SL4F--2R2B	Latitude LED flashing warning light, 4 Head, alternating RBRB	\$350.00	\$179.85
336320	Federal Signal	SL4F-2R2W	Latitude LED flashing warning light, 4 Head, alternating RWRW	\$350.00	\$179.85
336320	Federal Signal	SL4F-A	Latitude LED flashing warning light, 4 Head, AAAA	\$350.00	\$179.85
336320	Federal Signal	SL4F-AAWW	Latitude Warning Light, 4-Head flashing model, (2) Amber LEDs, (2) White LEDs	\$350.00	\$179.85
336320	Federal Signal	SL4F-B	Latitude LED flashing warning light, 4 Head, BBBB	\$350.00	\$179.85
336320	Federal Signal	SL4F-R	Latitude LED flashing warning light, 4 Head, RRRR	\$350.00	\$179.85
336320	Federal Signal	SL4F-RB	Latitude LED flashing warning light, 4 Head, RRBB	\$350.00	\$179.85
336320	Federal Signal	SL4F-WWAA	Latitude Warning Light, 4-Head flashing model, (2) Amber LEDs, (2) White LEDs	\$350.00	\$179.85
336320	Federal Signal	SL4SS-MODOT	Latitude, Split, SignalMaster/Modot	\$636.00	\$326.81
336320	Federal Signal	SL6F-A	Latitude LED flashing warning light, , 6 Head, AAAAAA	\$503.00	\$258.47
336320	Federal Signal	SL6F-AW	Latitude LED flashing warning light, SignalMaster, 6 Head, AWAWAW	\$503.00	\$258.47
336320	Federal Signal	SL6F-B	Latitude LED flashing warning light, SignalMaster, 6 Head, BBBBBB	\$503.00	\$258.47
336320	Federal Signal	SL6F-BR	Latitude LED flashing warning light, SignalMaster, 6 Head, BBBRRR	\$503.00	\$258.47
336320	Federal Signal	SL6FF-RW	6HD FLASHING STCK LGHT WLC,	\$503.00	\$258.47
336320	Federal Signal	SL6F-R	Latitude LED flashing warning light, SignalMaster, 6 Head, RRRRRR	\$503.00	\$258.47
336320	Federal Signal	SL6F-RB	Latitude LED flashing warning light, SignalMaster, 6 Head, RRRBBB	\$503.00	\$258.47
336320	Federal Signal	SL6S-A	Latitude LED Amber flashing warning light, SignalMaster, 6 Head	\$545.00	\$280.05
336320	Federal Signal	SL8C-BAB	LATITUDE SIGNALMASTER, 1 BLUE, 6 AMBER, 1 BLUE - BAAAAAB	\$568.00	\$291.87
336320	Federal Signal	SL8C-BBB	LATITUDE SIGNALMASTER, 8 BLUE - BBBB BBBB	\$568.00	\$291.87
336320	Federal Signal	SL8C-RAB	LATITUDE SIGNALMASTER, 1 RED, 6 AMBER, 1 BLUE - RAAAAAB	\$568.00	\$291.87
336320	Federal Signal	SL8C-RAR	LATITUDE SIGNALMASTER, 1 RED, 6 AMBER, 1 RED - RAAAAAR	\$568.00	\$291.87

336320	Federal Signal	SL8F-4R4B	Latitude LED flashing warning light, SignalMaster, 8 Head, RBRBRBRB	\$568.00	\$291.87
336320	Federal Signal	SL8F-A	Latitude LED flashing warning light, 8 Head, AAAAAAAA	\$568.00	\$291.87
336320	Federal Signal	SL8F-AW	Latitude LED flashing warning light, SignalMaster, 8 Head, AWAWAWAW	\$568.00	\$291.87
336320	Federal Signal	SL8F-B	Latitude LED flashing warning light, SignalMaster, 8 Head, BBBB BBBB	\$568.00	\$291.87
336320	Federal Signal	SL8F-BA	Latitude LED flashing warning light, SignalMaster, 8 Head, BBABBABB	\$568.00	\$291.87
336320	Federal Signal	SL8F-BR	Latitude LED flashing warning light, SignalMaster, 8 Head, BBBBRRRR	\$568.00	\$291.87
336320	Federal Signal	SL8FF-RW	8HD FLASHING STCK LGHT WLC,	\$568.00	\$291.87
336320	Federal Signal	SL8F-R	Latitude LED flashing warning light, SignalMaster, 8 Head, RRRRRRRR	\$568.00	\$291.87
336320	Federal Signal	SL8F-RB	Latitude LED flashing warning light, SignalMaster, 8 Head, RRRRB BBB	\$568.00	\$291.87
336320	Federal Signal	SL8S-A	Latitude LED Amber flashing warning light, SignalMaster, 8 Head	\$611.00	\$313.96
336320	Federal Signal	SL8S-A48	48" LATITUDE SIGNALMASTER	\$693.00	\$356.10
336320	Federal Signal	SL8S-A48-1DEU	Latitude, 48" SignalMaster	\$680.00	\$349.42
336320	Federal Signal	SL8S-A48-50	Latitude SignalMaster, 8 Amber LED heads, SignalMaster economy controller, 50 ft cable.	\$737.00	\$378.71
336320	Federal Signal	SL8S-A-50	Latitude SignalMaster, 8 Amber LED heads, SignalMaster economy controller, 50 ft cable.	\$681.00	\$349.93
336320	Federal Signal	SL8S-RB	SIGNALMASTER,SOLARIS,8HD	\$598.00	\$307.28
336320	Federal Signal	SLB-001	KIT,BRKT, LONG,CNSM/LAT	\$29.00	\$14.90
336320	Federal Signal	SLB-002	Short L Bracket, CN SignalMaster or Latitude	\$34.00	\$17.47
336320	Federal Signal	SLB-4SHRD	KIT,4HD SHROUD,CNSM/LAT	\$34.00	\$17.47
336320	Federal Signal	SLB-6SHRD	KIT,6HD SHROUD,LAT	\$36.00	\$18.50
336320	Federal Signal	SLB-8SHRD	KIT,8HD SHROUD,CNSM/LAT	\$39.00	\$20.04
336320	Federal Signal	SLB-FRD15ND	Bracket Kit, DNSM/Latitude, 15 F-150	\$44.00	\$22.61
336320	Federal Signal	SMCABLE-15	Must order(1) with each 8200S SignalMaster, 15 ft cable, discrete	\$171.00	\$87.87
336320	Federal Signal	SMCABLE-30	Must order(1) with each 8200S SignalMaster, 30 ft cable, discrete	\$229.00	\$117.67
336320	Federal Signal	SMCONTROL	SignalMaster Controller, cable length 20 ft.	\$357.00	\$183.45
336320	Federal Signal	SSP2000B	SmartSiren Platinum 2000, 100W, Programmable siren/light controller	\$1,590.00	\$817.03
336320	Federal Signal	SSP2000B-200	SmartSiren Platinum 2000, 100/200W, Programmable siren/light controller	\$1,630.00	\$837.58
336320	Federal Signal	SSP2000B-3BOS200	SmartSiren Platinum, 3 Bos 200 Control	\$1,050.00	\$539.55
336320	Federal Signal	SSP3000B	SmartSiren Platinum 3000, 100/200W, Programmable siren/light controller	\$2,109.75	\$1,084.10
336320	Federal Signal	SSP3K-RMK	SSP 3001 Kit, Remote Microphone	\$126.00	\$64.75
336320	Federal Signal	SW200-012	Switch Control SW200 Series, (4) 20A fused switches	\$212.00	\$108.94
336320	Federal Signal	SW30	Switch Control SW30 Series, (3) 20A toggle switches on L bracket housing	\$49.00	\$25.18
336320	Federal Signal	SW300-012	Switch Control SW300 Series, (1) 40A and (5) 20A fused switches	\$237.00	\$121.78
336320	Federal Signal	SW-BK1	TRUNION MOUNT,SW200-012	\$28.00	\$14.39
336320	Federal Signal	SWM1	Interceptor Switch Module	\$489.00	\$251.27
336320	Federal Signal	SWM2	Interceptor Switch Module	\$489.00	\$251.27
336320	Federal Signal	SY12SSA	SENTRY,95FPM,12V,SURF MT	\$155.00	\$79.65
336320	Federal Signal	TS100-N	TS100-N Speaker, 100W, high-output, standard bracket	\$265.00	\$136.17
336320	Federal Signal	U300	Control Unit, LD300/CO301	\$270.00	\$138.74
336320	Federal Signal	ULM20-SSP	Common Mic Adapter for SmartSiren Platinum	\$425.00	\$218.39
336320	Federal Signal	UM3500K	Undercover Rotary Switch	\$363.00	\$186.53
336320	Federal Signal	UNHK	Mounting Bars, mounting kit permanent, hook mount feet.	\$79.00	\$40.59
336320	Federal Signal	UNPK	Mounting Bars, mounting kit permanent	\$79.00	\$40.59
336320	Federal Signal	UPKM-3	Park Siren Deactivator	\$68.00	\$34.94
336320	Federal Signal	UTMPA6	Touchmaster, PA, Air Horn, Siren	\$1,006.00	\$516.94
336320	Federal Signal	VAL44J-F1H	44 in., Red/White, White TD/Alley Lights, Amber SignalMaster, Hook mount	\$3,580.00	\$1,839.60
336320	Federal Signal	VAL44J-F1HM	44 in., Red/White, White TD/Alley Lights, Amber SignalMaster, Hook mount, Serial Interface Module	\$3,650.00	\$1,875.57
336320	Federal Signal	VAL44J-F2H	44 in., Red/White, White TD/Alley Lights, White Flood, Amber SignalMaster, Hook mount	\$4,030.00	\$2,070.83
336320	Federal Signal	VAL44J-F2HM	44 in., Red/White, White TD/Alley Lights, White Flood, Amber SignalMaster, Serial Interface Module, Hook mount	\$4,100.00	\$2,106.80

336320	Federal Signal	VALOR1-FHP-PACKAGE-MARK-CHGR	Package includes 44" Valor Lightbar, SSP-2000B-200 Siren, AS124 Speaker-Vertical Mount (2), Speaker mounting bracket (2)	\$5,635.00	\$2,895.57
336320	Federal Signal	VALR44J-P1H	44 in., Red/Blue, White LED TD/Alley Lights, White LED Flood, Amber SignalMaster, Hook mount	\$4,030.00	\$2,070.83
336320	Federal Signal	VALR44J-P1L	44 in., Red/Blue, White LED TD/Alley Lights, White LED Flood, Amber SignalMaster, Low Hook mount	\$4,030.00	\$2,070.83
336320	Federal Signal	VALR44J-P2L	44 in., Blue/Blue, White LED TD/Alley Lights, White LED Flood, Amber SignalMaster, Low Hook mount	\$4,030.00	\$2,070.83
336320	Federal Signal	VALR44S-AMBR2	44" MODELS, HOOK MOUNT AND 6 BUTTON CONTROLLER INCLUDED, 14 AMBER/WHITE MODULES, 10 AMBER MODULES, SIGNALMASTER, FRONT FLOOD FEATURE	\$4,392.00	\$2,256.85
336320	Federal Signal	VALR44S-AMBR3	44" MODELS, HOOK MOUNT AND 6 BUTTON CONTROLLER INCLUDED, 22 AMBER/WHITE MODULES, 2 AMBER MODULES, SIGNALMASTER, FULL FLOOD FEATURE	\$4,752.00	\$2,441.83
336320	Federal Signal	VALR51J-F1H	51 in., Red/White, White TD/Alley Lights, Amber SignalMaster, Hook mount	\$4,050.00	\$2,081.11
336320	Federal Signal	VALR51J-F1HM	51 in., Red/White, White TD/Alley Lights, Amber SignalMaster, Hook mount, Serial Interface Module	\$4,120.00	\$2,117.08
336320	Federal Signal	VALR51J-F2H	51 in., Red/White, White TD/Alley Lights, White Flood, Amber SignalMaster, Hook mount	\$4,590.00	\$2,358.59
336320	Federal Signal	VALR51J-F2HM	51 in., Red/White, White TD/Alley Lights, White Flood, Amber SignalMaster, Serial Interface Module, Hook mount	\$4,660.00	\$2,394.56
336320	Federal Signal	VALR51J-P1H	51 in., Red/Blue, White LED TD/Alley Lights, White LED Flood, Amber SignalMaster, Hook mount	\$4,590.00	\$2,358.59
336320	Federal Signal	VALR51J-P1L	51 in., Red/Blue, White LED TD/Alley Lights, White LED Flood, Amber SignalMaster, Low Hook mount	\$4,590.00	\$2,358.59
336320	Federal Signal	VALR51J-P2L	51 in., Blue/Blue, White LED TD/Alley Lights, White LED Flood, Amber SignalMaster, Low Hook mount	\$4,590.00	\$2,358.59
336320	Federal Signal	VALR51S-AMBR2	51" MODELS, HOOK MOUNT AND 6 BUTTON CONTROLLER INCLUDED, 12 AMBER MODULES, 16 AMBER/WHITE LED MODULES, SIGNALMASTER, FRONT FLOOD FEATURE	\$4,952.00	\$2,544.60
336320	Federal Signal	VALR51S-AMBR23	Valor Light Bar, 51", with hook mount and 6-button controller, (10) Amber, (16) Amber/white, (2) S/T/T lights, SignalMaster, front flood feature.	\$5,142.00	\$2,642.24
336320	Federal Signal	VALR51S-AMBR3	51 in., (24) Amber/White modules, (4) Amber modules, SignalMaster, front and rear flood	\$5,312.00	\$2,729.59
336320	Federal Signal	VB24S	VisiBeam, 24V, Surface Mount	\$603.00	\$309.85
336320	Federal Signal	V-FASTK	KIT,VECTOR,FAST ROT.	\$143.00	\$73.48
336320	Federal Signal	V-MEDK	KIT,MED.VECTOR,ROTATOR	\$143.00	\$73.48
336320	Federal Signal	V-OSCK	KIT,VECTOR,FRNT OSC. LIGH	\$143.00	\$73.48
336320	Federal Signal	VPX-SW	VPX8, rear side window mount brackets, (2) Viper EXT lights, late model CV Police Package vehicles	\$75.00	\$38.54
336320	Federal Signal	V-ROTK	KIT,VECTOR,ROTATOR	\$143.00	\$73.48
336320	Federal Signal	VSLR3S-NFPA1	3-Pod Vision SLR Red/Multi/Red, (2) all Red LED rotators, (1) multi-colored LED rotators, discreet wiring, Red and Clear domes, permanent mount	\$2,128.00	\$1,093.48
336320	Federal Signal	VSLR3S-NFPA3	3-Pod Vision SLR Red/Multi/Red, (2) all Red LED rotators, (1) multi-colored LED rotators, discreet wiring, Clear domes,	\$2,128.00	\$1,093.48
336320	Federal Signal	VSLR46-2664017	46" Vision SLR, V-Shape Light Bar with Red/White/Blue, Takedown lights, Alley lights, Amber SignalMaster, No Serial Interface Module and hook kit.	\$5,495.00	\$2,823.63
336320	Federal Signal	VSLR46-2664023	46" Vision SLR, V-Shape Light Bar with Red/White/Blue, Takedown lights, Alley lights, Amber SignalMaster, Serial Interface Module and hook kit.	\$5,565.00	\$2,859.60
336320	Federal Signal	VSLR46S-2664009	46" Vision SLR, V-Shape Light Bar with Red/Blue, Takedown lights, Alley lights, Flood Lights,Amber SignalMaster, No Serial Interface Module and hook kit.	\$5,900.00	\$3,031.74
336320	Federal Signal	VSLR46S-2664014	46" Vision SLR, V-Shape Light Bar with Red/Blue, Takedown lights, Alley lights, Flood Lights, Amber SignalMaster, Serial Interface Module and hook kit.	\$5,970.00	\$3,067.71
336320	Federal Signal	VSLR46S-NFPA1	46" Vision SLR-NFPA Red/Multi/Red, (5) all Red LED rotators, (2) multi-colored LED rotators, interface module, Red and Clear domes, no SignalMaster, Black hook-on mount	\$4,895.00	\$2,515.31
336320	Federal Signal	VSLR46S-NFPA2	46" Vision SLR-NFPA Red/Multi/Red, (4) all Red LED rotators, (3) multi-colored LED rotators, interface module, Red and Clear domes, no SignalMaster, Black hook-on mount	\$5,095.00	\$2,618.09
336320	Federal Signal	VSLR46S-NFPA3	46" Vision SLR-NFPA Red/Multi/Red, (5) all Red LED rotators, (2) multi-colored LED rotators, interface module, Clear domes, no SignalMaster, Black hook-on mount	\$4,895.00	\$2,515.31

336320	Federal Signal	VSLR46S-NFPA4	46" Vision SLR-NFPA Red/Multi/Red, (4) all Red LED rotators, (3) multi-colored LED rotators, interface module, Clear domes, no SignalMaster, Black hook-on mount	\$5,095.00	\$2,618.09
336320	Federal Signal	VSLR53S-NFPA1	53" Vision SLR-NFPA Red/Multi/Red, (5) all Red LED rotators, (2) multi-colored LED rotators, interface module, Red and Clear domes, no SignalMaster, Black hook-on mount	\$5,095.00	\$2,618.09
336320	Federal Signal	VSLR53S-NFPA2	53" Vision SLR-NFPA Red/Multi/Red, (4) all Red LED rotators, (3) multi-colored LED rotators, interface module, Red and Clear domes, no SignalMaster, Black hook-on mount	\$5,295.00	\$2,720.86
336320	Federal Signal	VSLR53S-NFPA3	53" Vision SLR-NFPA Red/Multi/Red, (5) all Red LED rotators, (2) multi-colored LED rotators, interface module, Clear domes, no SignalMaster, Black hook-on mount	\$5,095.00	\$2,618.09
336320	Federal Signal	VSLR53S-NFPA4	53" Vision SLR-NFPA Red/Multi/Red, (4) all Red LED rotators, (3) multi-colored LED rotators, interface module, Clear domes, no SignalMaster, Black hook-on mount	\$5,295.00	\$2,720.86
336320	Federal Signal	VSLR60S-NFPA1	60" Vision SLR-NFPA Red/Multi/Red, (5) all Red LED rotators, (2) multi-colored LED rotators, interface module, Red and Clear domes, no SignalMaster, Permanent Mount	\$5,195.00	\$2,669.47
336320	Federal Signal	VSLR60S-NFPA2	60" Vision SLR-NFPA Red/Multi/Red, (4) all Red LED rotators, (3) multi-colored LED rotators, interface module, Red and Clear domes, no SignalMaster, Black hook-on mount	\$5,395.00	\$2,772.24
336320	Federal Signal	VSLR60S-NFPA3	60" Vision SLR-NFPA Red/Multi/Red, (5) all Red LED rotators, (2) multi-colored LED rotators, interface module, Clear domes, no SignalMaster, Black hook-on mount	\$5,195.00	\$2,669.47
336320	Federal Signal	VSLR60S-NFPA4	60" Vision SLR NFPA Red/Multi/Red, (4) all Red LED rotators, (3) multi-colored LED rotators, interface module, Clear domes, no SignalMaster, Black hook-on mount	\$5,395.00	\$2,772.24
336320	Federal Signal	VSLR6S-NFPA1	6-Pod Split Vision SLR Red/Multi/Red, (4) all Red LED rotators, (2) multi-colored LED rotators, discreet wiring, Red and Clear domes, no SignalMaster, permanent mount	\$4,095.00	\$2,104.23
336320	Federal Signal	VSLR6S-NFPA3	6-Pod Split Vision SLR Red/Multi/Red, (4) all Red LED rotators, (2) multi-colored LED rotators, discreet wiring, Clear domes, no SignalMaster, permanent mount	\$4,095.00	\$2,104.23
336320	Federal Signal	VSLR8S-NFPA1	8-Pod Split Vision SLR Red/Multi/Red, (6) all Red LED rotators, (2) multi-colored LED rotators, discreet wiring, Red and Clear domes, permanent Mount	\$4,595.00	\$2,361.16
336320	Federal Signal	VSLR8S-NFPA2	8-Pod Split Vision SLR Red/Multi/Red, (4) all Red LED rotators, (4) multi-colored LED rotators, discreet wiring, Red and Clear domes, permanent mount	\$4,845.00	\$2,489.62
336320	Federal Signal	VSLR8S-NFPA3	8-Pod Split Vision SLR Red/Multi/Red, (6) all Red LED rotators, (2) multi-colored LED rotators, discreet wiring, Clear domes, permanent mount	\$4,595.00	\$2,361.16
336320	Federal Signal	VSLR8S-NFPA4	8-Pod Split Vision SLR Red/Multi/Red, (4) all Red LED rotators, (4) multi-colored LED rotators, discreet wiring, Clear domes, permanent mount	\$4,845.00	\$2,489.62
336320	Federal Signal	XSM1-BRA-US	Xstream, Single head with wire leads, SpectraLux multicolor LED technology, includes light head, two suction cups, bail and pivot bracket, mounting hardware and three different length snap-on flash guards, Blue/Red/Amber	\$219.00	\$112.53
336320	Federal Signal	XSM1-BRW-US	XStream single head model with wire leads, Blue/Red/White	\$219.00	\$112.53
336320	Federal Signal	XSM1-BWA-US	Xstream, Single head with wire leads, SpectraLux multicolor LED technology, includes light head, two suction cups, bail and pivot bracket, mounting hardware and three different length snap-on flash guards, White/White/Amber	\$219.00	\$112.53
336320	Federal Signal	XSM1C-BRW-US	XStream single head model with Cigarette Plug, Blue/Red/White	\$219.00	\$112.53
336320	Federal Signal	XSM1C-BWA-US	Xstream, Single head with cigarette plug, SpectraLux multicolor LED technology, includes light head, two suction cups, bail and pivot bracket, mounting hardware and three different length snap-on flash guards, Blue/White/Amber	\$219.00	\$112.53
336320	Federal Signal	XSM1C-RWA-US	Xstream, Single head with cigarette plug, SpectraLux multicolor LED technology, includes light head, two suction cups, bail and pivot bracket, mounting hardware and three different length snap-on flash guards, Red/White/Amber	\$219.00	\$112.53
336320	Federal Signal	XSM1C-WAG-US	Xstream, Single head with cigarette plug, SpectraLux multicolor LED technology, includes light head, two suction cups, bail and pivot bracket, mounting hardware and three different length snap-on flash guards, White/Amber/Green	\$219.00	\$112.53
336320	Federal Signal	XSM1-WAG-US	Xstream, Single head with wire leads, SpectraLux multicolor LED technology, includes light head, two suction cups, bail and pivot bracket, mounting hardware and three different length snap-on flash guards, White/Amber/Green	\$439.00	\$225.58

336320	Federal Signal	XSM2-BRA-US	Xstream, Dual head with wire leads, SpectraLux multicolor LED technology, includes light head, two suction cups, bail and pivot bracket, mounting hardware and three different length snap-on flash guards, Blue/Red/Amber-Red/Blue/Amber	\$439.00	\$225.58
336320	Federal Signal	XSM2-BRW-US	XStream Dual head model with wire leads, Blue/Red/White	\$439.00	\$225.58
336320	Federal Signal	XSM2-BWA-US	Xstream, Dual Head with wire leads, SpectraLux multicolor LED technology, includes light head, two suction cups, bail and pivot bracket, mounting hardware and three different length snap-on flash guards, Blue/White/Amber-Blue/White/Amber	\$439.00	\$225.58
336320	Federal Signal	XSM2C-BRW-US	XStream Dual head model with cigarette plug, Blue/Red/White	\$439.00	\$225.58
336320	Federal Signal	XSM2C-BWA-US	Xstream, Dual head with cigarette plug, SpectraLux multicolor LED technology, includes light head, two suction cups, bail and pivot bracket, mounting hardware and three different length snap-on flash guards, Blue/White/Amber-Blue/White/Amber	\$439.00	\$225.58
336320	Federal Signal	XSM2C-RWA-US	Xstream, Dual head with cigarette plug, SpectraLux multicolor LED technology, includes light head, two suction cups, bail and pivot bracket, mounting hardware and three different length snap-on flash guards, Red/White/Amber-Red/White/Amber	\$439.00	\$225.58
336320	Federal Signal	XSM2C-WAG-US	Xstream, Dual head with cigarette plug, SpectraLux multicolor LED technology, includes light head, two suction cups, bail and pivot bracket, mounting hardware and three different length snap-on flash guards, White/Amber/Green-White/Amber/Green	\$439.00	\$225.58
336320	Federal Signal	XSM2-WAG-US	Xstream, Dual head with wire leads, SpectraLux multicolor LED technology, includes light head, two suction cups, bail and pivot bracket, mounting hardware and three different length snap-on flash guards, White/Amber/Green-White/Amber/Green	\$439.00	\$225.58
336320	Federal Signal	XSMBKT01	XStream model bracket	\$29.00	\$14.90
336320	Federal Signal	XSMBKT02	XStream model bracket	\$45.00	\$23.12
336320	Federal Signal	XSMBKT03	XStream model bracket	\$21.00	\$10.79
336320	Federal Signal	XSMBKT07	Visor mount kit for use with (1) single or dual head Xstream and (2) cameras (forward rear facing), Dodge Charger 2011-2019	\$85.00	\$43.68
336320	Federal Signal	XSMBKT08	Visor mount kit for use with (1) single or dual head Xstream and (2) cameras (forward rear facing), Ford Police Interceptor Utility 2011-2019	\$85.00	\$43.68
336320	Federal Signal	XSMBKT09	Visor mount kit for use with (1) single or dual head Xstream and (2) cameras (forward rear facing), Chevy Tahoe 2015-2019	\$85.00	\$43.68
336320	Federal Signal	XSMBKT10	Visor Mount Kit for use with (1) single or dual head Xstream and (2) cameras (forward rear facing), Ford F-150, 2015-2019, and Ford F-250-350-450-550 Super Duty, 2017-2019	\$85.00	\$43.68
336320	Federal Signal	XSMBKT11	Visor mount kit for use with (1) XSM1/XSM2 and (2) cameras (forward and rear facing), Ford Police Interceptor Utility 2020	\$85.00	\$43.68
336320	Federal Signal	Z124161A	HighLighter LED kit base	\$46.00	\$23.64
336320	Federal Signal	Z1751531A	Relacement 6-button controller	\$451.00	\$231.75
336320	Federal Signal	Z258B577D-03	PF200R - RJ11 microphone	\$101.00	\$51.90
336320	Federal Signal	Z8280090A	100 Watt NEO Driver	\$227.00	\$116.64
336320	Federal Signal	Z8433039B	Remote Control	\$149.00	\$76.56
336320	Federal Signal	Z8433113A	Transmitter, Wireless	\$162.00	\$83.24
336320	Federal Signal	Z861302679A	Pair of PIT bar brackets for use on a PBX-PIT04 PIT bar for a 2015-2019 Dodge Charger Pursuit. Each bracket holds a single MPS600U or MPS620U light.	\$45.00	\$23.12
336320	Federal Signal	Z861302757A	Pair of B-Pillar brackets, each bracket mounts (1) MPS650 or MPS652 light on the pillar, Dodge Charger, 2011-2019, Ford Police Interceptor Utility, 2011-2019	\$40.00	\$20.55
336320	Federal Signal	Z861302781A	Pair of B-Pillar brackets, each bracket mounts (1) MPS650 or MPS652 light on the pillar, Chevy Tahoe, 2015-2019, Ford Police Interceptor Utility, 2020.	\$40.00	\$20.55
336320	Federal Signal	Z862302151A	PF200R - Replacement remote control head	\$400.00	\$205.54
336320	Federal Signal	Z8653101C-01	Replacement end dome for Allegiant and Legend light bars, black	\$55.00	\$28.26
336320	Federal Signal	Z8653103C-01	Replacement center dome for Allegiant and Legend light bars, black	\$43.00	\$22.10
336320	Jotto Patriot	410-1255	63" x 46" Floor Plank Kit (Transit Connect)	\$340.07	\$287.82
336320	Jotto Patriot	410-1256	44" x 46" Floor Plank Kit (Transit Connect)	\$331.89	\$280.89
336320	Jotto Patriot	410-1300	Jotto-Cargo Slide - Transit Connect '10-'13 (Full Length)	\$1,013.22	\$857.54
336320	Jotto Patriot	410-1301	Jotto-Cargo Slide - Transit Connect '10-'13 (Half Length)	\$1,013.22	\$857.54
336320	Jotto Patriot	410-9037	Jotto-Cargo Slide	\$1,504.05	\$1,272.95
336320	Jotto Patriot	410-9038	Jotto-Cargo Slide	\$1,135.93	\$961.39
336320	Jotto Patriot	410-9040	Jotto-Cargo Slide	\$1,013.22	\$857.54
336320	Jotto Patriot	410-9046	Jotto-Cargo Slide	\$1,135.93	\$961.39
336320	Jotto Patriot	410-9055	Jotto-Cargo Slide	\$1,381.35	\$1,169.10
336320	Jotto Patriot	410-9057	Jotto-Cargo Slide (Avalanche/Escalade)	\$1,013.22	\$857.54
336320	Jotto Patriot	410-9060	65" x 49" Floor Plank Kit	\$340.07	\$287.82



336320	Jotto Patriot	410-9061	76" x 49" Floor Plank Kit	\$386.82	\$327.38
336320	Jotto Patriot	410-9062	95" x 49" Floor Plank Kit	\$481.49	\$407.51
336320	Jotto Patriot	410-9064	63" x 49" Floor Plank Kit	\$340.07	\$287.82
336320	Jotto Patriot	410-9067	Jotto-Cargo Slide	\$1,381.35	\$1,169.10
336320	Jotto Patriot	410-9071	Jotto-Cargo Slide	\$1,994.88	\$1,688.36
336320	Jotto Patriot	410-9073	80" x 49" Floor Plank Kit	\$399.68	\$338.27
336320	Jotto Patriot	410-9075	74" x 49" Floor Plank Kit	\$386.82	\$327.38
336320	Jotto Patriot	410-9076	Jotto-Cargo Slide	\$1,994.88	\$1,688.36
336320	Jotto Patriot	410-9128	Jotto-Cargo Slide (Mid-Size)	\$1,135.93	\$961.39
336320	Jotto Patriot	410-9130	Jotto Cargo Slide (Mid-Size)	\$1,013.22	\$857.54
336320	Jotto Patriot	410-9534	Accessory, Rear Dual Basket	\$255.94	\$216.61
336320	Jotto Patriot	410-9592	Accessory, Side Basket	\$108.69	\$91.99
336320	Jotto Patriot	410-9798	72" x 40" Floor Plank Kit (Mid-Size)	\$380.98	\$322.44
336320	Jotto Patriot	410-9799	58" x 40" Floor Plank Kit (Mid-Size)	\$331.89	\$280.89
336320	Jotto Patriot	410-9800	Jotto-Cargo Slide w/flooring, 08-14 Suburban	\$1,013.22	\$857.54
336320	Jotto Patriot	410-9801	Jotto-Cargo Slide w/flooring, 08-14 Tahoe	\$1,013.22	\$857.54
336320	Jotto Patriot	410-9817	Jotto-Cargo Slide w/flooring, 15+ Tahoe (PPV ONLY - Will NOT Work in Civilian Version)	\$1,013.22	\$857.54
336320	Jotto Patriot	410-9887	Tie Downs (set of 4)	\$61.94	\$52.42
336320	Jotto Patriot	410-9888	Cargo Barrier Bracket w/Tie Downs (set of 2)	\$92.33	\$78.14
336320	Jotto Patriot	425-0009	Expedition 16-17 Floor Plate Legs (Front/Rear Legs)	\$119.21	\$94.89
336320	Jotto Patriot	425-0010	PI Utility 2020+ NHM Base OnlyNo Holes	\$153.09	\$121.86
336320	Jotto Patriot	425-0011	PI Utility 2020+ HD NHM Base OnlyNo Holes	\$280.48	\$223.25
336320	Jotto Patriot	425-0013	Explorer 2020+ NHM Base OnlyNo Holes	\$153.09	\$121.86
336320	Jotto Patriot	425-0014	Littlite UV Viewer (UVV)	\$136.45	\$108.61
336320	Jotto Patriot	425-0017	Hinged Armrest, Brother Printer Mount	\$435.75	\$346.84
336320	Jotto Patriot	425-0018	Escape 2020+	\$153.09	\$121.86
336320	Jotto Patriot	425-0032	HD F-150 15-17 (28" FLP - Front/Rear Legs)	\$184.64	\$146.97
336320	Jotto Patriot	425-0033	HD F-150 15-17 Floor Plate Legs (Front/Rear Legs)	\$102.84	\$81.86
336320	Jotto Patriot	425-0150/4138	Mamba Mount w/A-MOD (Tall Clamps)	\$709.70	\$564.90
336320	Jotto Patriot	425-0150/4139	Mamba Mount w/A-MOD XL (Short Clamps)	\$709.70	\$564.90
336320	Jotto Patriot	425-0150/4152	Mamba Mount w/A-MOD (Short Clamps)	\$709.70	\$564.90
336320	Jotto Patriot	425-0150/4154	Mamba Mount w/A-MOD XL (Tall Clamps)	\$709.70	\$564.90
336320	Jotto Patriot	425-1021	Universal - 3" x 6" w 7/8" StudUniversal Mounting	\$40.91	\$32.56
336320	Jotto Patriot	425-1188	Articulated - 1" x 13.75"	\$128.55	\$102.32
336320	Jotto Patriot	425-1201	Straight - 1 1/4" x 9"	\$91.75	\$73.03
336320	Jotto Patriot	425-1308	Cable - Dock - Smart Phone Holder (Mounts w/Side Saddle)	\$46.75	\$37.21
336320	Jotto Patriot	425-1317	Kensington - Lock Securing System	\$58.43	\$46.51
336320	Jotto Patriot	425-1478	Dual Cup Holder Rubber Cup Retainer Replacement (425-6033)	\$7.01	\$5.58
336320	Jotto Patriot	425-1485	Utility Box - Center Console (2.75" x 4" x8.5")	\$58.43	\$46.51
336320	Jotto Patriot	425-1486	Utility Box -2 Cup Insert, Explorer Style	\$28.05	\$22.33
336320	Jotto Patriot	425-1530	Utility Box - Standard Consoles ( 2.75" x 4" x 8.5")	\$58.43	\$46.51
336320	Jotto Patriot	425-1552	Hanging File Box - Armrest, Lid w/Lock (12" x 4.5" x 13.5")	\$186.98	\$148.83
336320	Jotto Patriot	425-1598	PI Utility 16-19 Max Depth CSM Stiffener Bracket (use w/425-2827)Console Side Mounted	\$29.22	\$23.26
336320	Jotto Patriot	425-1604	Floor Plate - Extruded, 28" Section Only	\$86.48	\$68.84
336320	Jotto Patriot	425-1719	3 " Face Plate Lift Bracket	\$56.09	\$44.65
336320	Jotto Patriot	425-1756	2" Face Plate Lift Bracket	\$56.09	\$44.65
336320	Jotto Patriot	425-1760	4" Face Plate Lift Bracket	\$56.09	\$44.65
336320	Jotto Patriot	425-1848	Rear Hinged Armrest, Max Depth, PI Utility 16-19	\$175.30	\$139.53
336320	Jotto Patriot	425-1849	Side Mount Arm Rest (Works with 425-6491 & 425-6500)	\$129.11	\$102.77
336320	Jotto Patriot	425-1892	Expedition 00-06 / Lincoln NavigatorNo Holes	\$153.09	\$121.86
336320	Jotto Patriot	425-1912	Mic Clip - Magnetic	\$15.19	\$12.09
336320	Jotto Patriot	425-2082	Accessory - 12" Desk USB Light (works with A-MOD Desktop)	\$58.43	\$46.51
336320	Jotto Patriot	425-2096	Escape 01-12 / Mazda Tribute 01-05No Holes	\$153.09	\$121.86
336320	Jotto Patriot	425-2131	Dakota 03-09No Holes	\$153.09	\$121.86
336320	Jotto Patriot	425-2158	Lock Replacement for Some Locking Faceplate (425-6345, 425-2691, 425-6088, 425-2929, 425-6417)	\$36.23	\$28.84
336320	Jotto Patriot	425-2215	Mic Clip -- Smooth Glide Only	\$28.05	\$22.33
336320	Jotto Patriot	425-2250	Side Sliding Armrest, PI Utility 2020+	\$78.75	\$62.68
336320	Jotto Patriot	425-2273	12V Lighter Replacement (Red Rubber Cap)	\$12.85	\$10.23
336320	Jotto Patriot	425-2490	Accessory - 12" Desk USB Light (works with ACD Desktop)	\$58.43	\$46.51
336320	Jotto Patriot	425-2496	Pad - Foam Replacements (set of 6)	\$5.85	\$4.66
336320	Jotto Patriot	425-2585	Tahoe 00-14 "Retrofit Floorplate MountNo Holes	\$127.39	\$101.40
336320	Jotto Patriot	425-2598	Accessory, 12" EMS Utility Divider, Universal	\$43.24	\$34.42
336320	Jotto Patriot	425-2691	Accessory, 6" EMS Lid w/ Lock	\$82.97	\$66.04

336320	Jotto Patriot	425-2692	EMS Utility Package#3 (12" Box w/2 dividers/ 6" Box w/Lid & Lock) , Universal	\$427.73	\$340.46
336320	Jotto Patriot	425-2693	Utility Box, 12" EMS, Universal	\$163.61	\$130.23
336320	Jotto Patriot	425-2694	Utility Box, 6" EMS, Universal	\$154.27	\$122.79
336320	Jotto Patriot	425-2695	Accessory, 6" EMS Faceplate Rail (Pair), Universal	\$66.78	\$53.15
336320	Jotto Patriot	425-2717	Ticket Book Holder - Fits To Back of Standard Consoles	\$52.59	\$41.86
336320	Jotto Patriot	425-2775	12" Console Mounted LED Light - Hardwired	\$61.94	\$49.30
336320	Jotto Patriot	425-2797	Expedition 95-02 (2pc.)No Holes	\$153.09	\$121.86
336320	Jotto Patriot	425-2827	Console Side Mount (Base Only - used on 425-5542, 425-5614, and 425-5599)Console Side Mounted	\$146.92	\$116.94
336320	Jotto Patriot	425-2865	Lock Replacement for Storage Box - Faceplate (425-6611, 425-6111, 425-1552, 425-6216, 425-6039, 425-6031)	\$17.54	\$13.96
336320	Jotto Patriot	425-2943	Cup Holder (set of 2 each) Plastic Cup Retainer - Charger Console & Explorer Console	\$24.54	\$19.53
336320	Jotto Patriot	425-2995	Blazer/Jimmy 97-05No Holes	\$153.09	\$121.86
336320	Jotto Patriot	425-2998	F-150 04-09 / Mark LT 06-09No Holes	\$153.09	\$121.86
336320	Jotto Patriot	425-3012	S10/Sonoma 97-05No Holes	\$153.09	\$121.86
336320	Jotto Patriot	425-3018	Malibu 2015No Holes	\$153.09	\$121.86
336320	Jotto Patriot	425-3028	Extension - 1" x 7" (WAS 425-5171)	\$100.17	\$79.73
336320	Jotto Patriot	425-3041	Cup Holder - Single (external mount) (3.5" x 4.75" x 4.75")(was 425-2139)	\$61.94	\$49.30
336320	Jotto Patriot	425-3045	Straight - 1" x 10.75" (was 425-1608)	\$94.05	\$74.86
336320	Jotto Patriot	425-3061	Mic Clip - Dual- Use with Crown Victoria only!!!!(was 425-2146)	\$54.93	\$43.72
336320	Jotto Patriot	425-3062	Straight - 1" x 6.75" (was 425-1854)	\$82.36	\$65.56
336320	Jotto Patriot	425-3071	Straight - 1" x 8.75" (was 425-1920)	\$84.70	\$67.42
336320	Jotto Patriot	425-3075	Bullet 07-09No Holes	\$153.09	\$121.86
336320	Jotto Patriot	425-3076	Camaro 97-02No Holes	\$153.09	\$121.86
336320	Jotto Patriot	425-3077	Malibu 04-14 / Pontiac G6 05-10 N/A For Malibu ClassicNo Holes	\$153.09	\$121.86
336320	Jotto Patriot	425-3078	Freestar 04-07 / Windstar 99-03No Holes	\$153.09	\$121.86
336320	Jotto Patriot	425-3084	Sprinter 04-06 VanNo Holes	\$153.09	\$121.86
336320	Jotto Patriot	425-3085	E-Series Van 99-14No Holes	\$153.09	\$121.86
336320	Jotto Patriot	425-3098	500 & Freestyle, Montego 05-07 / Taurus, and Sable 08-09No Holes	\$153.09	\$121.86
336320	Jotto Patriot	425-3099	Excursion 04-05No Holes	\$153.09	\$121.86
336320	Jotto Patriot	425-3101	Savana / Express 03+No Holes	\$153.09	\$121.86
336320	Jotto Patriot	425-3123	Fusion 07-12No Holes	\$153.09	\$121.86
336320	Jotto Patriot	425-3133	Expedition 07-17 / Navigator Base 07+No Holes	\$153.09	\$121.86
336320	Jotto Patriot	425-3134	Charger 08-10 - Base (Police Package Only -- Seat Bolt Mounted)No Holes	\$153.09	\$121.86
336320	Jotto Patriot	425-3167	Mustang 05-08No Holes	\$153.09	\$121.86
336320	Jotto Patriot	425-3169	Sprinter Van 07+No Holes	\$153.09	\$121.86
336320	Jotto Patriot	425-3187	Impala 06-17 (Police Package), Impala 06-13 (Consumer Model) Mounts to Passenger Seat RailsNo Holes	\$153.09	\$121.86
336320	Jotto Patriot	425-3194	Stratus 00-04No Holes	\$153.09	\$121.86
336320	Jotto Patriot	425-3238	AK12 P2 PLATE(CF28, CF29, CF30)	\$66.61	\$53.02
336320	Jotto Patriot	425-3243	Tahoe / Suburban / Silverado 2500-3500 / Sierra 2500-3500 00-14 / Silverado 1500 / Sierra 1500 00-13No Holes	\$153.09	\$121.86
336320	Jotto Patriot	425-3360	Tube - 1" x 10" Round Vertical Tube (was 425-1393)	\$31.55	\$25.11
336320	Jotto Patriot	425-3399	Hinged Armrest	\$239.58	\$190.70
336320	Jotto Patriot	425-3438	Ram SSV 09+ ***Will NOT Fit All New 2019 DT...WILL Fit 2019 DS (SSV)***No Holes	\$153.09	\$121.86
336320	Jotto Patriot	425-3460	Transit Connect 10-13No Holes	\$153.09	\$121.86
336320	Jotto Patriot	425-3526	Explorer 2011No Holes	\$153.09	\$121.86
336320	Jotto Patriot	425-3534	Silverado 1500 14-18 / Tahoe/Suburban 15+ / Silverado 2500 15-19No Holes	\$153.09	\$121.86
336320	Jotto Patriot	425-3551	F-150 10-14No Holes	\$153.09	\$121.86
336320	Jotto Patriot	425-3560	F-250-550 11-16No Holes	\$153.09	\$121.86
336320	Jotto Patriot	425-3576	Charger 11+ Base (Police Package Only -- Seat Bolt Mounted)No Holes	\$153.09	\$121.86
336320	Jotto Patriot	425-3581	Traverse 10-17No Holes	\$153.09	\$121.86
336320	Jotto Patriot	425-3655	Journey 13+No Holes	\$153.09	\$121.86
336320	Jotto Patriot	425-3657	Durango 11+No Holes	\$157.77	\$125.58
336320	Jotto Patriot	425-3685	Caprice 11-13No Holes	\$153.09	\$121.86
336320	Jotto Patriot	425-3692	Microphone Bracket	\$17.54	\$13.96
336320	Jotto Patriot	425-3704	4" Dual ABS Cup Holder (Internally Mounted)	\$60.77	\$48.37
336320	Jotto Patriot	425-3752	NV Van 2011+ (Will NOT Fit NV200 Van)No Holes	\$153.09	\$121.86
336320	Jotto Patriot	425-3753	PI Sedan 13+ NHM Base OnlyNo Holes	\$153.09	\$121.86
336320	Jotto Patriot	425-3754	PI Utility 13-19 NHM Base OnlyNo Holes	\$153.09	\$121.86

336320	Jotto Patriot	425-3756	Ram SSV 15+ HD BaseNo Holes	\$280.48	\$223.25
336320	Jotto Patriot	425-3759	Full Size Spare Relocation Kit - Charger 11+DODGE	\$56.09	\$47.47
336320	Jotto Patriot	425-3761	Console Side Mount (Base Only - used on 425-5597 - works on 425-6175 and 425-6644 CC/CD Console Only)Console Side Mounted	\$172.52	\$137.32
336320	Jotto Patriot	425-3763	F-250+ 15-16 HD BaseNo Holes	\$280.48	\$223.25
336320	Jotto Patriot	425-3765	Explorer 12-19No Holes	\$153.09	\$121.86
336320	Jotto Patriot	425-3767	Escape 13-19No Holes	\$153.09	\$121.86
336320	Jotto Patriot	425-3768	PI Utility 20+ CSM Stiffener Brackets (use w/425-2827)Console Side Mounted	\$42.00	\$33.43
336320	Jotto Patriot	425-3769	Dodge Ram DT 2021+	\$153.09	\$121.86
336320	Jotto Patriot	425-3772	PI Sedan 13+ CSM Stiffener Bracket (use w/425-2827)Console Side Mounted	\$29.22	\$23.26
336320	Jotto Patriot	425-3773	PI Utility 13-19 CSM Stiffener Bracket (use w/425-2827)Console Side Mounted	\$29.22	\$23.26
336320	Jotto Patriot	425-3800	Fusion 13-17No Holes	\$153.09	\$121.86
336320	Jotto Patriot	425-3814	Impala 18+ (Admin Package) 14+ (Consumer Only)No Holes	\$153.09	\$121.86
336320	Jotto Patriot	425-3816	Magnetic Microphone System, Single Pack	\$34.95	\$27.82
336320	Jotto Patriot	425-3817	Magnetic Microphone System, Five Pack	\$174.75	\$139.10
336320	Jotto Patriot	425-3818	Magnetic Microphone System, Twenty Five Pack	\$724.75	\$576.88
336320	Jotto Patriot	425-3819	Caprice 14+No Holes	\$153.09	\$121.86
336320	Jotto Patriot	425-3826	Ram ProMaster 14+ (Does NOT Fit ProMaster City or Work with P/S Double Seat)No Holes	\$153.09	\$121.86
336320	Jotto Patriot	425-3837	Transit 15+ (DO NOT CONFUSE FOR TRANSIT CONNECT)No Holes	\$153.09	\$121.86
336320	Jotto Patriot	425-3841	Side Hinged Armrest, IPBCC, PI Utility 13-19	\$204.52	\$162.79
336320	Jotto Patriot	425-3842	Magnetic Mic Mounting Bracket	\$17.54	\$13.96
336320	Jotto Patriot	425-3843	Side Hinged Armrest, IPBCC, Tahoe	\$178.80	\$142.32
336320	Jotto Patriot	425-3859	Armrest Replacement Kit, Large	\$73.50	\$58.50
336320	Jotto Patriot	425-3860	Armrest Replacement Kit, Small	\$47.25	\$37.61
336320	Jotto Patriot	425-4026	Face Plate - 4" Locking Utility Box (3.75" x 2.625" x 7.3125")	\$170.29	\$135.55
336320	Jotto Patriot	425-5005/4131	Journey 13+No Holes	\$543.43	\$432.55
336320	Jotto Patriot	425-5005/4143	Journey 13+No Holes	\$613.55	\$488.37
336320	Jotto Patriot	425-5005/4144	Journey 13+No Holes	\$613.55	\$488.37
336320	Jotto Patriot	425-5005/5182	Journey 13+No Holes	\$327.22	\$260.46
336320	Jotto Patriot	425-5005/5215	Journey 13+No Holes	\$397.34	\$316.27
336320	Jotto Patriot	425-5010/4131	PI Utility 2020+No Holes	\$543.43	\$432.55
336320	Jotto Patriot	425-5010/4143	PI Utility 2020+No Holes	\$613.55	\$488.37
336320	Jotto Patriot	425-5010/4144	PI Utility 2020+No Holes	\$613.55	\$488.37
336320	Jotto Patriot	425-5010/5182	PI Utility 2020+No Holes	\$327.22	\$260.46
336320	Jotto Patriot	425-5010/5215	PI Utility 2020+No Holes	\$397.34	\$316.27
336320	Jotto Patriot	425-5015/4131	Tahoe 00-14/ Silverado 2500+ / Suburban 00+ / Sierra 1500 / Silverado 1500 00-13 28"FLP/POST/ARM/10"8" Stand/ACDNo Holes	\$543.43	\$432.55
336320	Jotto Patriot	425-5015/4143	Tahoe 00-14/ Silverado 2500+ / Suburban 00+ / Sierra 1500 / Silverado 1500 00-13 28"FLP/POST/ARM/10"8" Stand/ACDNo Holes	\$613.55	\$488.37
336320	Jotto Patriot	425-5015/4144	Tahoe 00-14/ Silverado 2500+ / Suburban 00+ / Sierra 1500 / Silverado 1500 00-13 28"FLP/POST/ARM/10"8" Stand/ACDNo Holes	\$613.55	\$488.37
336320	Jotto Patriot	425-5015/5182	Tahoe 00-14/ Silverado 2500+ / Suburban 00+ / Sierra 1500 / Silverado 1500 00-13 28"FLP/POST/ARM/10"8" Stand/ACDNo Holes	\$327.22	\$260.46
336320	Jotto Patriot	425-5015/5215	Tahoe 00-14/ Silverado 2500+ / Suburban 00+ / Sierra 1500 / Silverado 1500 00-13 28"FLP/POST/ARM/10"8" Stand/ACDNo Holes	\$524.73	\$417.67
336320	Jotto Patriot	425-5019/4131	PI Sedan 13+No Holes	\$543.43	\$432.55
336320	Jotto Patriot	425-5019/4143	PI Sedan 13+No Holes	\$613.55	\$488.37
336320	Jotto Patriot	425-5019/4144	PI Sedan 13+No Holes	\$613.55	\$488.37
336320	Jotto Patriot	425-5019/5182	PI Sedan 13+No Holes	\$327.22	\$260.46
336320	Jotto Patriot	425-5019/5215	PI Sedan 13+No Holes	\$397.34	\$316.27
336320	Jotto Patriot	425-5020/4131	Escape 13-19No Holes	\$543.43	\$432.55
336320	Jotto Patriot	425-5020/4143	Escape 13-19No Holes	\$613.55	\$488.37
336320	Jotto Patriot	425-5020/4144	Escape 13-19No Holes	\$613.55	\$488.37
336320	Jotto Patriot	425-5020/5182	Escape 13-19No Holes	\$327.22	\$260.46
336320	Jotto Patriot	425-5020/5215	Escape 13-19No Holes	\$397.34	\$316.27
336320	Jotto Patriot	425-5023/4131	PI Utility 13-19No Holes	\$543.43	\$432.55
336320	Jotto Patriot	425-5023/4143	PI Utility 13-19No Holes	\$613.55	\$488.37
336320	Jotto Patriot	425-5023/4144	PI Utility 13-19No Holes	\$613.55	\$488.37

336320	Jotto Patriot	425-5023/5182	PI Utility 13-19No Holes	\$327.22	\$260.46
336320	Jotto Patriot	425-5023/5215	PI Utility 13-19No Holes	\$397.34	\$316.27
336320	Jotto Patriot	425-5026/4138	PI Sedan 13+ HD MountNo Holes	\$894.02	\$711.61
336320	Jotto Patriot	425-5026/4139	PI Sedan 13+ HD MountNo Holes	\$894.02	\$711.61
336320	Jotto Patriot	425-5028/4131	Fusion / Fusion Hybrid / Police Responder Hybrid 18+No Holes	\$543.43	\$432.55
336320	Jotto Patriot	425-5028/4143	Fusion / Fusion Hybrid / Police Responder Hybrid 18+No Holes	\$613.55	\$488.37
336320	Jotto Patriot	425-5028/4144	Fusion / Fusion Hybrid / Police Responder Hybrid 18+No Holes	\$613.55	\$488.37
336320	Jotto Patriot	425-5028/5182	Fusion / Fusion Hybrid / Police Responder Hybrid 18+No Holes	\$327.22	\$260.46
336320	Jotto Patriot	425-5028/5215	Fusion / Fusion Hybrid / Police Responder Hybrid 18+No Holes	\$397.34	\$316.27
336320	Jotto Patriot	425-5029	Fusion / Fusion Hybrid / Police Responder Hybrid 18+No Holes	\$153.09	\$121.86
336320	Jotto Patriot	425-5032/4138	PI Utility 2020+ HD MountNo Holes	\$894.02	\$711.61
336320	Jotto Patriot	425-5032/4139	PI Utility 2020+ HD MountNo Holes	\$894.02	\$711.61
336320	Jotto Patriot	425-5037/4131	Explorer 2020+No Holes	\$543.43	\$432.55
336320	Jotto Patriot	425-5037/4143	Explorer 2020+No Holes	\$613.55	\$488.37
336320	Jotto Patriot	425-5037/4144	Explorer 2020+No Holes	\$613.55	\$488.37
336320	Jotto Patriot	425-5037/5182	Explorer 2020+No Holes	\$327.22	\$260.46
336320	Jotto Patriot	425-5037/5215	Explorer 2020+No Holes	\$397.34	\$316.27
336320	Jotto Patriot	425-5046/4131	F-150 18+ (ALL CONFIGURATIONS) 15-17 (OEM CONSOLE)No Holes	\$543.43	\$432.55
336320	Jotto Patriot	425-5046/4143	F-150 18+ (ALL CONFIGURATIONS) 15-17 (OEM CONSOLE)No Holes	\$613.55	\$488.37
336320	Jotto Patriot	425-5046/4144	F-150 18+ (ALL CONFIGURATIONS) 15-17 (OEM CONSOLE)No Holes	\$613.55	\$488.37
336320	Jotto Patriot	425-5046/5182	F-150 18+ (ALL CONFIGURATIONS) 15-17 (OEM CONSOLE)No Holes	\$327.22	\$260.46
336320	Jotto Patriot	425-5046/5215	F-150 18+ (ALL CONFIGURATIONS) 15-17 (OEM CONSOLE)No Holes	\$397.34	\$316.27
336320	Jotto Patriot	425-5047/4131	Ram DT 2021+	\$543.43	\$432.55
336320	Jotto Patriot	425-5047/4143	Ram DT 2021+	\$613.55	\$488.37
336320	Jotto Patriot	425-5047/4144	Ram DT 2021+	\$613.55	\$488.37
336320	Jotto Patriot	425-5047/5182	Ram DT 2021+	\$327.22	\$260.46
336320	Jotto Patriot	425-5047/5215	Ram DT 2021+	\$397.34	\$316.27
336320	Jotto Patriot	425-5050/4131	Traverse 10-17No Holes	\$543.43	\$432.55
336320	Jotto Patriot	425-5050/4143	Traverse 10-17No Holes	\$613.55	\$488.37
336320	Jotto Patriot	425-5050/4144	Traverse 10-17No Holes	\$613.55	\$488.37
336320	Jotto Patriot	425-5050/5182	Traverse 10-17No Holes	\$327.22	\$260.46
336320	Jotto Patriot	425-5050/5215	Traverse 10-17No Holes	\$397.34	\$316.27
336320	Jotto Patriot	425-5065	Flat - 6" x 6" w 7/8" Stud (Heavy Duty Truck - was 425-1458)Universal Mounting	\$75.97	\$60.47
336320	Jotto Patriot	425-5071	Power Supply - 3 Outlet DC	\$23.37	\$18.60
336320	Jotto Patriot	425-5078/4131	Fusion 07-12No Holes	\$543.43	\$432.55
336320	Jotto Patriot	425-5078/4143	Fusion 07-12No Holes	\$613.55	\$488.37
336320	Jotto Patriot	425-5078/4144	Fusion 07-12No Holes	\$613.55	\$488.37
336320	Jotto Patriot	425-5078/5182	Fusion 07-12No Holes	\$327.22	\$260.46
336320	Jotto Patriot	425-5078/5215	Fusion 07-12No Holes	\$397.34	\$316.27
336320	Jotto Patriot	425-5086/4131	Malibu 2015No Holes	\$543.43	\$432.55
336320	Jotto Patriot	425-5086/4143	Malibu 2015No Holes	\$613.55	\$488.37
336320	Jotto Patriot	425-5086/4144	Malibu 2015No Holes	\$613.55	\$488.37
336320	Jotto Patriot	425-5086/5182	Malibu 2015No Holes	\$327.22	\$260.46
336320	Jotto Patriot	425-5086/5215	Malibu 2015No Holes	\$397.34	\$316.27
336320	Jotto Patriot	425-5104/4138	F-150 15+ HD MountNo Holes	\$894.02	\$711.61
336320	Jotto Patriot	425-5104/4139	F-150 15+ HD MountNo Holes	\$894.02	\$711.61
336320	Jotto Patriot	425-5107/4138	Ram SSV 15+ HD MountNo Holes	\$894.02	\$711.61
336320	Jotto Patriot	425-5107/4139	Ram SSV 15+ HD MountNo Holes	\$894.02	\$711.61
336320	Jotto Patriot	425-5117/4131	Tahoe / Suburban / Silverado 2500-3500 / Sierra 2500-3500 00-14 / Silverado 1500 / Sierra 1500 00-13No Holes	\$543.43	\$432.55
336320	Jotto Patriot	425-5117/4143	Tahoe / Suburban / Silverado 2500-3500 / Sierra 2500-3500 00-14 / Silverado 1500 / Sierra 1500 00-13No Holes	\$613.55	\$488.37
336320	Jotto Patriot	425-5117/4144	Tahoe / Suburban / Silverado 2500-3500 / Sierra 2500-3500 00-14 / Silverado 1500 / Sierra 1500 00-13No Holes	\$613.55	\$488.37
336320	Jotto Patriot	425-5117/5182	Tahoe / Suburban / Silverado 2500-3500 / Sierra 2500-3500 00-14 / Silverado 1500 / Sierra 1500 00-13No Holes	\$327.22	\$260.46
336320	Jotto Patriot	425-5117/5215	Tahoe / Suburban / Silverado 2500-3500 / Sierra 2500-3500 00-14 / Silverado 1500 / Sierra 1500 00-13No Holes	\$397.34	\$316.27
336320	Jotto Patriot	425-5121/4131	Fusion 13-17No Holes	\$543.43	\$432.55
336320	Jotto Patriot	425-5121/4143	Fusion 13-17No Holes	\$613.55	\$488.37
336320	Jotto Patriot	425-5121/4144	Fusion 13-17No Holes	\$613.55	\$488.37
336320	Jotto Patriot	425-5121/5182	Fusion 13-17No Holes	\$327.22	\$260.46

336320	Jotto Patriot	425-5121/5215	Fusion 13-17No Holes	\$397.34	\$316.27
336320	Jotto Patriot	425-5129/4131	Grand Caravan 08+ / Town & Country 08+No Holes	\$543.43	\$432.55
336320	Jotto Patriot	425-5129/4143	Grand Caravan 08+ / Town & Country 08+No Holes	\$613.55	\$488.37
336320	Jotto Patriot	425-5129/4144	Grand Caravan 08+ / Town & Country 08+No Holes	\$613.55	\$488.37
336320	Jotto Patriot	425-5129/5182	Grand Caravan 08+ / Town & Country 08+No Holes	\$327.22	\$260.46
336320	Jotto Patriot	425-5129/5215	Grand Caravan 08+ / Town & Country 08+No Holes	\$397.34	\$316.27
336320	Jotto Patriot	425-5133/4131	Universal - Standard Model w/12" RodFloor, Universal Mounting	\$420.71	\$334.87
336320	Jotto Patriot	425-5133/4143	Universal - Standard Model w/12" RodFloor, Universal Mounting	\$490.83	\$390.69
336320	Jotto Patriot	425-5133/4144	Universal - Standard Model w/12" RodFloor, Universal Mounting	\$490.83	\$390.69
336320	Jotto Patriot	425-5133/5182	Universal - Standard Model w/12" RodFloor, Universal Mounting	\$204.52	\$162.79
336320	Jotto Patriot	425-5133/5215	Universal - Standard Model w/12" RodFloor, Universal Mounting	\$274.64	\$218.61
336320	Jotto Patriot	425-5159	Cable - Dock - Cell Phone Holder (Mounts w/Side Saddle)	\$22.21	\$17.68
336320	Jotto Patriot	425-5182	Mounting Plate GK - Kodiak/Gamber/Havis/LedCo Docks-Desktops	\$64.28	\$51.16
336320	Jotto Patriot	425-5186	Writing - 12" x 13" (for use with Articulated Swing Arm)	\$65.45	\$52.10
336320	Jotto Patriot	425-5201	Auxiliary - 7" x 10" w/ Long Clip	\$59.60	\$47.44
336320	Jotto Patriot	425-5202	Auxiliary - 7" x 10" w/ Short Clip	\$59.60	\$47.44
336320	Jotto Patriot	425-5203	Mounting Plate - 6" x 6" w/ 5/8" stud	\$39.73	\$31.62
336320	Jotto Patriot	425-5210/4131	Console Side Mount - 733 Model w/Articulating ArmConsole Side Mounted	\$412.53	\$328.36
336320	Jotto Patriot	425-5210/4143	Console Side Mount - 733 Model w/Articulating ArmConsole Side Mounted	\$482.65	\$384.17
336320	Jotto Patriot	425-5210/4144	Console Side Mount - 733 Model w/Articulating ArmConsole Side Mounted	\$482.65	\$384.17
336320	Jotto Patriot	425-5210/5182	Console Side Mount - 733 Model w/Articulating ArmConsole Side Mounted	\$196.33	\$156.27
336320	Jotto Patriot	425-5210/5215	Console Side Mount - 733 Model w/Articulating ArmConsole Side Mounted	\$266.45	\$212.09
336320	Jotto Patriot	425-5212/4131	Universal - Standard Modell w/10" RodFloor, Universal Mounting	\$420.71	\$334.87
336320	Jotto Patriot	425-5212/4143	Universal - Standard Modell w/10" RodFloor, Universal Mounting	\$490.83	\$390.69
336320	Jotto Patriot	425-5212/4144	Universal - Standard Modell w/10" RodFloor, Universal Mounting	\$490.83	\$390.69
336320	Jotto Patriot	425-5212/5182	Universal - Standard Modell w/10" RodFloor, Universal Mounting	\$204.52	\$162.79
336320	Jotto Patriot	425-5212/5215	Universal - Standard Modell w/10" RodFloor, Universal Mounting	\$274.64	\$218.61
336320	Jotto Patriot	425-5213/4131	Universal Tripod w/Auxiliary DesktopFloor, Universal Mounting	\$586.67	\$466.97
336320	Jotto Patriot	425-5213/4143	Universal Tripod w/Auxiliary DesktopFloor, Universal Mounting	\$656.79	\$522.78
336320	Jotto Patriot	425-5213/4144	Universal Tripod w/Auxiliary DesktopFloor, Universal Mounting	\$656.79	\$522.78
336320	Jotto Patriot	425-5213/5182	Universal Tripod w/Auxiliary DesktopFloor, Universal Mounting	\$370.46	\$294.87
336320	Jotto Patriot	425-5213/5215	Universal Tripod w/Auxiliary DesktopFloor, Universal Mounting	\$440.58	\$350.69
336320	Jotto Patriot	425-5214/4131	Flat - RV ModelFloor, Universal Mounting	\$467.46	\$372.08
336320	Jotto Patriot	425-5214/4143	Flat - RV ModelFloor, Universal Mounting	\$537.58	\$427.90
336320	Jotto Patriot	425-5214/4144	Flat - RV ModelFloor, Universal Mounting	\$537.58	\$427.90
336320	Jotto Patriot	425-5214/5182	Flat - RV ModelFloor, Universal Mounting	\$251.27	\$200.00
336320	Jotto Patriot	425-5214/5215	Flat - RV ModelFloor, Universal Mounting	\$321.38	\$255.81
336320	Jotto Patriot	425-5215	Cable - Dock - 10" x 12" ABS Plastic (22" Cables)	\$134.40	\$106.98
336320	Jotto Patriot	425-5224	Cable - Dock - Stationary Side Saddle	\$15.19	\$12.09
336320	Jotto Patriot	425-5225	Cable - Dock - Pivoting Side Saddle	\$35.06	\$27.91
336320	Jotto Patriot	425-5237	Cable - Dock - Upgrade Kit	\$85.31	\$67.90
336320	Jotto Patriot	425-5238	Brace Kit	\$66.61	\$53.02
336320	Jotto Patriot	425-5261/4131	Malibu 04-14 / Pontiac G6 05-10 N/A for Malibu ClassicNo Holes	\$543.43	\$432.55
336320	Jotto Patriot	425-5261/4143	Malibu 04-14 / Pontiac G6 05-10 N/A for Malibu ClassicNo Holes	\$613.55	\$488.37
336320	Jotto Patriot	425-5261/4144	Malibu 04-14 / Pontiac G6 05-10 N/A for Malibu ClassicNo Holes	\$613.55	\$488.37
336320	Jotto Patriot	425-5261/5182	Malibu 04-14 / Pontiac G6 05-10 N/A for Malibu ClassicNo Holes	\$327.22	\$260.46
336320	Jotto Patriot	425-5261/5215	Malibu 04-14 / Pontiac G6 05-10 N/A for Malibu ClassicNo Holes	\$397.34	\$316.27
336320	Jotto Patriot	425-5264/4131	Sprinter Van 04-06No Holes	\$543.43	\$432.55
336320	Jotto Patriot	425-5264/4143	Sprinter Van 04-06No Holes	\$613.55	\$488.37
336320	Jotto Patriot	425-5264/4144	Sprinter Van 04-06No Holes	\$613.55	\$488.37
336320	Jotto Patriot	425-5264/5182	Sprinter Van 04-06No Holes	\$327.22	\$260.46
336320	Jotto Patriot	425-5264/5215	Sprinter Van 04-06No Holes	\$397.34	\$316.27
336320	Jotto Patriot	425-5265/4131	500, Freestyle, & Montego 05-07 / Taurus and Sable '08-'09No Holes	\$543.43	\$432.55
336320	Jotto Patriot	425-5265/4143	500, Freestyle, & Montego 05-07 / Taurus and Sable '08-'09No Holes	\$613.55	\$488.37
336320	Jotto Patriot	425-5265/4144	500, Freestyle, & Montego 05-07 / Taurus and Sable '08-'09No Holes	\$613.55	\$488.37

336320	Jotto Patriot	425-5265/5182	500, Freestyle, & Montego 05-07 / Taurus and Sable '08-'09No Holes	\$327.22	\$260.46
336320	Jotto Patriot	425-5265/5215	500, Freestyle, & Montego 05-07 / Taurus and Sable '08-'09No Holes	\$397.34	\$316.27
336320	Jotto Patriot	425-5272	Brace Kit (Tri-pod)	\$101.67	\$80.93
336320	Jotto Patriot	425-5273	Articulated (3pc.) - 1" x 20"	\$211.47	\$168.32
336320	Jotto Patriot	425-5274/4131	Universal TripodFloor, Universal Mounting	\$496.68	\$395.34
336320	Jotto Patriot	425-5274/4143	Universal TripodFloor, Universal Mounting	\$566.80	\$451.16
336320	Jotto Patriot	425-5274/4144	Universal TripodFloor, Universal Mounting	\$566.80	\$451.16
336320	Jotto Patriot	425-5274/5182	Universal TripodFloor, Universal Mounting	\$280.48	\$223.25
336320	Jotto Patriot	425-5274/5215	Universal TripodFloor, Universal Mounting	\$350.60	\$279.07
336320	Jotto Patriot	425-5276/4131	Excursion 04-05No Holes	\$543.43	\$432.55
336320	Jotto Patriot	425-5276/4143	Excursion 04-05No Holes	\$613.55	\$488.37
336320	Jotto Patriot	425-5276/4144	Excursion 04-05No Holes	\$613.55	\$488.37
336320	Jotto Patriot	425-5276/5182	Excursion 04-05No Holes	\$327.22	\$260.46
336320	Jotto Patriot	425-5276/5215	Excursion 04-05No Holes	\$397.34	\$316.27
336320	Jotto Patriot	425-5285/4131	Ram ProMaster 14+ (Does NOT Fit ProMaster City or Work with P/S Double Seat)No Holes	\$543.43	\$432.55
336320	Jotto Patriot	425-5285/4143	Ram ProMaster 14+ (Does NOT Fit ProMaster City or Work with P/S Double Seat)No Holes	\$613.55	\$488.37
336320	Jotto Patriot	425-5285/4144	Ram ProMaster 14+ (Does NOT Fit ProMaster City or Work with P/S Double Seat)No Holes	\$613.55	\$488.37
336320	Jotto Patriot	425-5285/5182	Ram ProMaster 14+ (Does NOT Fit ProMaster City or Work with P/S Double Seat)No Holes	\$327.22	\$260.46
336320	Jotto Patriot	425-5285/5215	Ram ProMaster 14+ (Does NOT Fit ProMaster City or Work with P/S Double Seat)No Holes	\$397.34	\$316.27
336320	Jotto Patriot	425-5299	Accessory - Pivoting Small Cell Phone Holder Combo	\$56.04	\$44.61
336320	Jotto Patriot	425-5315/4131	Standard 97-05 -(Fits many Vehicle Types, Please call for assistance)No Holes	\$543.43	\$432.55
336320	Jotto Patriot	425-5315/4143	Standard 97-05 -(Fits many Vehicle Types, Please call for assistance)No Holes	\$613.55	\$488.37
336320	Jotto Patriot	425-5315/4144	Standard 97-05 -(Fits many Vehicle Types, Please call for assistance)No Holes	\$613.55	\$488.37
336320	Jotto Patriot	425-5315/5182	Standard 97-05 -(Fits many Vehicle Types, Please call for assistance)No Holes	\$327.22	\$260.46
336320	Jotto Patriot	425-5315/5215	Standard 97-05 -(Fits many Vehicle Types, Please call for assistance)No Holes	\$397.34	\$316.27
336320	Jotto Patriot	425-5321/4131	Expedition 95-99No Holes	\$543.43	\$432.55
336320	Jotto Patriot	425-5321/4143	Expedition 95-99No Holes	\$613.55	\$488.37
336320	Jotto Patriot	425-5321/4144	Expedition 95-99No Holes	\$613.55	\$488.37
336320	Jotto Patriot	425-5321/5182	Expedition 95-99No Holes	\$327.22	\$260.46
336320	Jotto Patriot	425-5321/5215	Expedition 95-99No Holes	\$397.34	\$316.27
336320	Jotto Patriot	425-5329/4131	Impala 00-05No Holes	\$543.43	\$432.55
336320	Jotto Patriot	425-5329/4143	Impala 00-05No Holes	\$613.55	\$488.37
336320	Jotto Patriot	425-5329/4144	Impala 00-05No Holes	\$613.55	\$488.37
336320	Jotto Patriot	425-5329/5182	Impala 00-05No Holes	\$327.22	\$260.46
336320	Jotto Patriot	425-5329/5215	Impala 00-05No Holes	\$397.34	\$316.27
336320	Jotto Patriot	425-5330	Mounting Plate - Panasonic WEB DockPanasonic	\$72.46	\$57.68
336320	Jotto Patriot	425-5335	Standard w/Cross Brace (2pc.) - (Fits many Vehicle Types, Please call for assistance)No Holes	\$153.09	\$121.86
336320	Jotto Patriot	425-5340/4131	Crown Victoria 97-12 / Lincoln Town Car 97-11 / Mercury Grand Marquis 97-11No Holes	\$543.43	\$432.55
336320	Jotto Patriot	425-5340/4143	Crown Victoria 97-12 / Lincoln Town Car 97-11 / Mercury Grand Marquis 97-11No Holes	\$613.55	\$488.37
336320	Jotto Patriot	425-5340/4144	Crown Victoria 97-12 / Lincoln Town Car 97-11 / Mercury Grand Marquis 97-11No Holes	\$613.55	\$488.37
336320	Jotto Patriot	425-5340/5182	Crown Victoria 97-12 / Lincoln Town Car 97-11 / Mercury Grand Marquis 97-11No Holes	\$327.22	\$260.46
336320	Jotto Patriot	425-5340/5215	Crown Victoria 97-12 / Lincoln Town Car 97-11 / Mercury Grand Marquis 97-11No Holes	\$397.34	\$316.27
336320	Jotto Patriot	425-5341	Assembly - 10" Rod, 10" Tube	\$53.76	\$42.79
336320	Jotto Patriot	425-5342	Assembly - 12" Rod, 10" Tube	\$59.60	\$47.44
336320	Jotto Patriot	425-5349/4131	Ram 02-08No Holes	\$543.43	\$432.55
336320	Jotto Patriot	425-5349/4143	Ram 02-08No Holes	\$613.55	\$488.37
336320	Jotto Patriot	425-5349/4144	Ram 02-08No Holes	\$613.55	\$488.37
336320	Jotto Patriot	425-5349/5182	Ram 02-08No Holes	\$327.22	\$260.46
336320	Jotto Patriot	425-5349/5215	Ram 02-08No Holes	\$397.34	\$316.27
336320	Jotto Patriot	425-5352	Assembly - 8" Rod, 7" Tube	\$53.76	\$42.79
336320	Jotto Patriot	425-5377	Assembly - 8" Rod, 10" Tube	\$53.76	\$42.79
336320	Jotto Patriot	425-5396/4131	Blazer / Jimmy 97-05No Holes	\$543.43	\$432.55

336320	Jotto Patriot	425-5396/4143	Blazer / Jimmy 97-05No Holes	\$613.55	\$488.37
336320	Jotto Patriot	425-5396/4144	Blazer / Jimmy 97-05No Holes	\$613.55	\$488.37
336320	Jotto Patriot	425-5396/5182	Blazer / Jimmy 97-05No Holes	\$327.22	\$260.46
336320	Jotto Patriot	425-5396/5215	Blazer / Jimmy 97-05No Holes	\$397.34	\$316.27
336320	Jotto Patriot	425-5398/4131	Expedition 00-06/ Lincoln NavigatorNo Holes	\$543.43	\$432.55
336320	Jotto Patriot	425-5398/4143	Expedition 00-06/ Lincoln NavigatorNo Holes	\$613.55	\$488.37
336320	Jotto Patriot	425-5398/4144	Expedition 00-06/ Lincoln NavigatorNo Holes	\$613.55	\$488.37
336320	Jotto Patriot	425-5398/5182	Expedition 00-06/ Lincoln NavigatorNo Holes	\$327.22	\$260.46
336320	Jotto Patriot	425-5398/5215	Expedition 00-06/ Lincoln NavigatorNo Holes	\$397.34	\$316.27
336320	Jotto Patriot	425-5423/4131	Escape 03-12/MarinerNo Holes	\$543.43	\$432.55
336320	Jotto Patriot	425-5423/4143	Escape 03-12/MarinerNo Holes	\$613.55	\$488.37
336320	Jotto Patriot	425-5423/4144	Escape 03-12/MarinerNo Holes	\$613.55	\$488.37
336320	Jotto Patriot	425-5423/5182	Escape 03-12/MarinerNo Holes	\$327.22	\$260.46
336320	Jotto Patriot	425-5423/5215	Escape 03-12/MarinerNo Holes	\$397.34	\$316.27
336320	Jotto Patriot	425-5424/4131	Dakota 03-09No Holes	\$543.43	\$432.55
336320	Jotto Patriot	425-5424/4143	Dakota 03-09No Holes	\$613.55	\$488.37
336320	Jotto Patriot	425-5424/4144	Dakota 03-09No Holes	\$613.55	\$488.37
336320	Jotto Patriot	425-5424/5182	Dakota 03-09No Holes	\$327.22	\$260.46
336320	Jotto Patriot	425-5424/5215	Dakota 03-09No Holes	\$397.34	\$316.27
336320	Jotto Patriot	425-5426/4131	F-150 04-09 Super Crew Cab/ Extended Cab / Mark LT 06-09No Holes	\$543.43	\$432.55
336320	Jotto Patriot	425-5426/4143	F-150 04-09 Super Crew Cab/ Extended Cab / Mark LT 06-09No Holes	\$613.55	\$488.37
336320	Jotto Patriot	425-5426/4144	F-150 04-09 Super Crew Cab/ Extended Cab / Mark LT 06-09No Holes	\$613.55	\$488.37
336320	Jotto Patriot	425-5426/5182	F-150 04-09 Super Crew Cab/ Extended Cab / Mark LT 06-09No Holes	\$327.22	\$260.46
336320	Jotto Patriot	425-5426/5215	F-150 04-09 Super Crew Cab/ Extended Cab / Mark LT 06-09No Holes	\$397.34	\$316.27
336320	Jotto Patriot	425-5454/4131	Expedition 07-17 / Navigator 07+No Holes	\$543.43	\$432.55
336320	Jotto Patriot	425-5454/4143	Expedition 07-17 / Navigator 07+No Holes	\$613.55	\$488.37
336320	Jotto Patriot	425-5454/4144	Expedition 07-17 / Navigator 07+No Holes	\$613.55	\$488.37
336320	Jotto Patriot	425-5454/5182	Expedition 07-17 / Navigator 07+No Holes	\$327.22	\$260.46
336320	Jotto Patriot	425-5454/5215	Expedition 07-17 / Navigator 07+No Holes	\$397.34	\$316.27
336320	Jotto Patriot	425-5456/4131	Sprinter Van 07+No Holes	\$543.43	\$432.55
336320	Jotto Patriot	425-5456/4143	Sprinter Van 07+No Holes	\$613.55	\$488.37
336320	Jotto Patriot	425-5456/4144	Sprinter Van 07+No Holes	\$613.55	\$488.37
336320	Jotto Patriot	425-5456/5182	Sprinter Van 07+No Holes	\$327.22	\$260.46
336320	Jotto Patriot	425-5456/5215	Sprinter Van 07+No Holes	\$397.34	\$316.27
336320	Jotto Patriot	425-5461	Assembly - 12" Rod, 20" Tube	\$105.18	\$83.72
336320	Jotto Patriot	425-5466/4131	Savana / Express 03+No Holes	\$543.43	\$432.55
336320	Jotto Patriot	425-5466/4143	Savana / Express 03+No Holes	\$613.55	\$488.37
336320	Jotto Patriot	425-5466/4144	Savana / Express 03+No Holes	\$613.55	\$488.37
336320	Jotto Patriot	425-5466/5182	Savana / Express 03+No Holes	\$327.22	\$260.46
336320	Jotto Patriot	425-5466/5215	Savana / Express 03+No Holes	\$397.34	\$316.27
336320	Jotto Patriot	425-5508	Rockover Height Adjustable Keyboard Mount Bracket	\$66.61	\$53.02
336320	Jotto Patriot	425-5540/4131	Charger 08-10 (Police Package Only -- Seat Bolt Mounted)No Holes	\$543.43	\$432.55
336320	Jotto Patriot	425-5540/4143	Charger 08-10 (Police Package Only -- Seat Bolt Mounted)No Holes	\$613.55	\$488.37
336320	Jotto Patriot	425-5540/4144	Charger 08-10 (Police Package Only -- Seat Bolt Mounted)No Holes	\$613.55	\$488.37
336320	Jotto Patriot	425-5540/5182	Charger 08-10 (Police Package Only -- Seat Bolt Mounted)No Holes	\$327.22	\$260.46
336320	Jotto Patriot	425-5540/5215	Charger 08-10 (Police Package Only -- Seat Bolt Mounted)No Holes	\$397.34	\$316.27
336320	Jotto Patriot	425-5542/4131	Console Side Mount (Fits 425-6473, 425-6636, 425-6621, 425-6626, 425-6445, 425-6417, 425-6418, 425-6385, 425-6268, 425-6478, 425-6193)Console Side Mounted	\$501.35	\$399.06
336320	Jotto Patriot	425-5542/4143	Console Side Mount (Fits 425-6473, 425-6636, 425-6621, 425-6626, 425-6445, 425-6417, 425-6418, 425-6385, 425-6268, 425-6478, 425-6193)Console Side Mounted	\$571.47	\$454.87
336320	Jotto Patriot	425-5542/4144	Console Side Mount (Fits 425-6473, 425-6636, 425-6621, 425-6626, 425-6445, 425-6417, 425-6418, 425-6385, 425-6268, 425-6478, 425-6193)Console Side Mounted	\$571.47	\$454.87
336320	Jotto Patriot	425-5542/5182	Console Side Mount (Fits 425-6473, 425-6636, 425-6621, 425-6626, 425-6445, 425-6417, 425-6418, 425-6385, 425-6268, 425-6478, 425-6193)Console Side Mounted	\$285.15	\$226.97

336320	Jotto Patriot	425-5542/5215	Console Side Mount (Fits 425-6473, 425-6636, 425-6621, 425-6626, 425-6445, 425-6417, 425-6418, 425-6385, 425-6268, 425-6478, 425-6193)Console Side Mounted	\$355.27	\$282.78
336320	Jotto Patriot	425-5543/4131	Mustang 05-08No Holes	\$543.43	\$432.55
336320	Jotto Patriot	425-5543/4143	Mustang 05-08No Holes	\$613.55	\$488.37
336320	Jotto Patriot	425-5543/4144	Mustang 05-08No Holes	\$613.55	\$488.37
336320	Jotto Patriot	425-5543/5182	Mustang 05-08No Holes	\$327.22	\$260.46
336320	Jotto Patriot	425-5543/5215	Mustang 05-08No Holes	\$397.34	\$316.27
336320	Jotto Patriot	425-5549	Auxiliary - 7" x 10" w/ No Clip	\$59.60	\$47.44
336320	Jotto Patriot	425-5569	Mount Plate for CF18/CF19Panasonic	\$72.46	\$57.68
336320	Jotto Patriot	425-5575/4131	Ram SSV 09+ / 19+ Ram Classic ***Will NOT Fit All New 2019 DT...WILL Fit 2019 DS (SSV)***No Holes	\$543.43	\$432.55
336320	Jotto Patriot	425-5575/4143	Ram SSV 09+ / 19+ Ram Classic ***Will NOT Fit All New 2019 DT...WILL Fit 2019 DS (SSV)***No Holes	\$613.55	\$488.37
336320	Jotto Patriot	425-5575/4144	Ram SSV 09+ / 19+ Ram Classic ***Will NOT Fit All New 2019 DT...WILL Fit 2019 DS (SSV)***No Holes	\$613.55	\$488.37
336320	Jotto Patriot	425-5575/5182	Ram SSV 09+ / 19+ Ram Classic ***Will NOT Fit All New 2019 DT...WILL Fit 2019 DS (SSV)***No Holes	\$327.22	\$260.46
336320	Jotto Patriot	425-5575/5215	Ram SSV 09+ / 19+ Ram Classic ***Will NOT Fit All New 2019 DT...WILL Fit 2019 DS (SSV)***No Holes	\$397.34	\$316.27
336320	Jotto Patriot	425-5579/4131	Taurus 10+No Holes	\$543.43	\$432.55
336320	Jotto Patriot	425-5579/4143	Taurus 10+No Holes	\$613.55	\$488.37
336320	Jotto Patriot	425-5579/4144	Taurus 10+No Holes	\$613.55	\$488.37
336320	Jotto Patriot	425-5579/5182	Taurus 10+No Holes	\$327.22	\$260.46
336320	Jotto Patriot	425-5579/5215	Taurus 10+No Holes	\$397.34	\$316.27
336320	Jotto Patriot	425-5585/4131	F-150 10-14No Holes	\$543.43	\$432.55
336320	Jotto Patriot	425-5585/4143	F-150 10-14No Holes	\$613.55	\$488.37
336320	Jotto Patriot	425-5585/4144	F-150 10-14No Holes	\$613.55	\$488.37
336320	Jotto Patriot	425-5585/5182	F-150 10-14No Holes	\$327.22	\$260.46
336320	Jotto Patriot	425-5585/5215	F-150 10-14No Holes	\$397.34	\$316.27
336320	Jotto Patriot	425-5586/4131	F-250-550 11-16No Holes	\$543.43	\$432.55
336320	Jotto Patriot	425-5586/4143	F-250-550 11-16No Holes	\$613.55	\$488.37
336320	Jotto Patriot	425-5586/4144	F-250-550 11-16No Holes	\$613.55	\$488.37
336320	Jotto Patriot	425-5586/5182	F-250-550 11-16No Holes	\$327.22	\$260.46
336320	Jotto Patriot	425-5586/5215	F-250-550 11-16No Holes	\$397.34	\$316.27
336320	Jotto Patriot	425-5588/4131	Malibu NextGen 2016+No Holes	\$543.43	\$432.55
336320	Jotto Patriot	425-5588/4143	Malibu NextGen 2016+No Holes	\$613.55	\$488.37
336320	Jotto Patriot	425-5588/4144	Malibu NextGen 2016+No Holes	\$613.55	\$488.37
336320	Jotto Patriot	425-5588/5182	Malibu NextGen 2016+No Holes	\$327.22	\$260.46
336320	Jotto Patriot	425-5588/5215	Malibu NextGen 2016+No Holes	\$397.34	\$316.27
336320	Jotto Patriot	425-5589/4131	Explorer 2011No Holes	\$543.43	\$432.55
336320	Jotto Patriot	425-5589/4143	Explorer 2011No Holes	\$613.55	\$488.37
336320	Jotto Patriot	425-5589/4144	Explorer 2011No Holes	\$613.55	\$488.37
336320	Jotto Patriot	425-5589/5182	Explorer 2011No Holes	\$327.22	\$260.46
336320	Jotto Patriot	425-5589/5215	Explorer 2011No Holes	\$397.34	\$316.27
336320	Jotto Patriot	425-5591/4131	Caprice 11-13No Holes	\$543.43	\$432.55
336320	Jotto Patriot	425-5591/4143	Caprice 11-13No Holes	\$613.55	\$488.37
336320	Jotto Patriot	425-5591/4144	Caprice 11-13No Holes	\$613.55	\$488.37
336320	Jotto Patriot	425-5591/5182	Caprice 11-13No Holes	\$327.22	\$260.46
336320	Jotto Patriot	425-5591/5215	Caprice 11-13No Holes	\$397.34	\$316.27
336320	Jotto Patriot	425-5595/4131	NV Van 11+ (Will NOT Fit NV200 Van)No Holes	\$543.43	\$432.55
336320	Jotto Patriot	425-5595/4143	NV Van 11+ (Will NOT Fit NV200 Van)No Holes	\$613.55	\$488.37
336320	Jotto Patriot	425-5595/4144	NV Van 11+ (Will NOT Fit NV200 Van)No Holes	\$613.55	\$488.37
336320	Jotto Patriot	425-5595/5182	NV Van 11+ (Will NOT Fit NV200 Van)No Holes	\$327.22	\$260.46
336320	Jotto Patriot	425-5595/5215	NV Van 11+ (Will NOT Fit NV200 Van)No Holes	\$397.34	\$316.27
336320	Jotto Patriot	425-5596/4119	Silverado 1500 14-18 / Tahoe 15+ / Silverado 2500 15-19No Holes	\$543.43	\$432.55
336320	Jotto Patriot	425-5596/4131	Silverado 1500 14-18 / Tahoe 15+ / Silverado 2500 15-19No Holes	\$543.43	\$432.55
336320	Jotto Patriot	425-5596/4143	Silverado 1500 14-18 / Tahoe 15+ / Silverado 2500 15-19No Holes	\$613.55	\$488.37
336320	Jotto Patriot	425-5596/4144	Silverado 1500 14-18 / Tahoe 15+ / Silverado 2500 15-19No Holes	\$613.55	\$488.37
336320	Jotto Patriot	425-5596/5182	Silverado 1500 14-18 / Tahoe 15+ / Silverado 2500 15-19No Holes	\$327.22	\$260.46
336320	Jotto Patriot	425-5596/5215	Silverado 1500 14-18 / Tahoe 15+ / Silverado 2500 15-19No Holes	\$397.34	\$316.27
336320	Jotto Patriot	425-5597/4131	Console Side Mount - Charger 12+ CC/CD Charger (Fits 425-6175 and 425-6644)Console Side Mounted	\$508.37	\$404.65



336320	Jotto Patriot	425-5597/4143	Console Side Mount - Charger 12+ CC/CD Charger (Fits 425-6175 and 425-6644)Console Side Mounted	\$578.49	\$460.46
336320	Jotto Patriot	425-5597/4144	Console Side Mount - Charger 12+ CC/CD Charger (Fits 425-6175 and 425-6644)Console Side Mounted	\$578.49	\$460.46
336320	Jotto Patriot	425-5597/5182	Console Side Mount - Charger 12+ CC/CD Charger (Fits 425-6175 and 425-6644)Console Side Mounted	\$292.16	\$232.55
336320	Jotto Patriot	425-5597/5215	Console Side Mount - Charger 12+ CC/CD Charger (Fits 425-6175 and 425-6644)Console Side Mounted	\$362.28	\$288.36
336320	Jotto Patriot	425-5599/4131	Console Side Mount - PI Sedan 13+ (Fits 425-6174)Console Side Mounted	\$508.37	\$404.65
336320	Jotto Patriot	425-5599/4143	Console Side Mount - PI Sedan 13+ (Fits 425-6174)Console Side Mounted	\$578.49	\$460.46
336320	Jotto Patriot	425-5599/4144	Console Side Mount - PI Sedan 13+ (Fits 425-6174)Console Side Mounted	\$578.49	\$460.46
336320	Jotto Patriot	425-5599/5182	Console Side Mount - PI Sedan 13+ (Fits 425-6174)Console Side Mounted	\$292.16	\$232.55
336320	Jotto Patriot	425-5599/5215	Console Side Mount - PI Sedan 13+ (Fits 425-6174)Console Side Mounted	\$362.28	\$288.36
336320	Jotto Patriot	425-5600/4131	Durango 11+No Holes	\$543.43	\$432.55
336320	Jotto Patriot	425-5600/4143	Durango 11+No Holes	\$613.55	\$488.37
336320	Jotto Patriot	425-5600/4144	Durango 11+No Holes	\$613.55	\$488.37
336320	Jotto Patriot	425-5600/5182	Durango 11+No Holes	\$327.22	\$260.46
336320	Jotto Patriot	425-5600/5215	Durango 11+No Holes	\$397.34	\$316.27
336320	Jotto Patriot	425-5601/4131	Grand Cherokee 11+No Holes	\$543.43	\$432.55
336320	Jotto Patriot	425-5601/4143	Grand Cherokee 11+No Holes	\$613.55	\$488.37
336320	Jotto Patriot	425-5601/4144	Grand Cherokee 11+No Holes	\$613.55	\$488.37
336320	Jotto Patriot	425-5601/5182	Grand Cherokee 11+No Holes	\$327.22	\$260.46
336320	Jotto Patriot	425-5601/5215	Grand Cherokee 11+No Holes	\$397.34	\$316.27
336320	Jotto Patriot	425-5603/4131	Explorer 12-19No Holes	\$543.43	\$432.55
336320	Jotto Patriot	425-5603/4143	Explorer 12-19No Holes	\$613.55	\$488.37
336320	Jotto Patriot	425-5603/4144	Explorer 12-19No Holes	\$613.55	\$488.37
336320	Jotto Patriot	425-5603/5182	Explorer 12-19No Holes	\$327.22	\$260.46
336320	Jotto Patriot	425-5603/5215	Explorer 12-19No Holes	\$397.34	\$316.27
336320	Jotto Patriot	425-5611	15" HD Stand/Arm/Tilt Assembly	\$303.85	\$241.86
336320	Jotto Patriot	425-5612/4131	Caprice 14+No Holes	\$543.43	\$432.55
336320	Jotto Patriot	425-5612/4143	Caprice 14+No Holes	\$613.55	\$488.37
336320	Jotto Patriot	425-5612/4144	Caprice 14+No Holes	\$613.55	\$488.37
336320	Jotto Patriot	425-5612/5182	Caprice 14+No Holes	\$327.22	\$260.46
336320	Jotto Patriot	425-5612/5215	Caprice 14+No Holes	\$397.34	\$316.27
336320	Jotto Patriot	425-5613	13" HD Stand/Arm/Tilt Assembly	\$303.85	\$241.86
336320	Jotto Patriot	425-5614/4131	Console Side Mount - PI Utility 16-19 (Fits 425-6479)Console Side Mounted	\$508.37	\$404.65
336320	Jotto Patriot	425-5614/4143	Console Side Mount - PI Utility 16-19 (Fits 425-6479)Console Side Mounted	\$578.49	\$460.46
336320	Jotto Patriot	425-5614/4144	Console Side Mount - PI Utility 16-19 (Fits 425-6479)Console Side Mounted	\$578.49	\$460.46
336320	Jotto Patriot	425-5614/5182	Console Side Mount - PI Utility 16-19 (Fits 425-6479)Console Side Mounted	\$292.16	\$232.55
336320	Jotto Patriot	425-5614/5215	Console Side Mount - PI Utility 16-19 (Fits 425-6479)Console Side Mounted	\$362.28	\$288.36
336320	Jotto Patriot	425-5615	Assembly Desktop Netbook	\$134.40	\$106.98
336320	Jotto Patriot	425-5619	Accessory - Pivoting Smart Phone Holder Combo	\$81.81	\$65.12
336320	Jotto Patriot	425-5624/4131	Transit Connect 14+No Holes	\$543.43	\$432.55
336320	Jotto Patriot	425-5624/4143	Transit Connect 14+No Holes	\$613.55	\$488.37
336320	Jotto Patriot	425-5624/4144	Transit Connect 14+No Holes	\$613.55	\$488.37
336320	Jotto Patriot	425-5624/5182	Transit Connect 14+No Holes	\$327.22	\$260.46
336320	Jotto Patriot	425-5624/5215	Transit Connect 14+No Holes	\$397.34	\$316.27
336320	Jotto Patriot	425-5625	Transit Connect 14+No Holes	\$153.09	\$121.86
336320	Jotto Patriot	425-5626/4131	Transit 15+ (DO NOT CONFUSE FOR TRANSIT CONNECT)No Holes	\$543.43	\$432.55
336320	Jotto Patriot	425-5626/4143	Transit 15+ (DO NOT CONFUSE FOR TRANSIT CONNECT)No Holes	\$613.55	\$488.37
336320	Jotto Patriot	425-5626/4144	Transit 15+ (DO NOT CONFUSE FOR TRANSIT CONNECT)No Holes	\$613.55	\$488.37
336320	Jotto Patriot	425-5626/5182	Transit 15+ (DO NOT CONFUSE FOR TRANSIT CONNECT)No Holes	\$327.22	\$260.46
336320	Jotto Patriot	425-5626/5215	Transit 15+ (DO NOT CONFUSE FOR TRANSIT CONNECT)No Holes	\$397.34	\$316.27
336320	Jotto Patriot	425-5627/4131	Focus 14+No Holes	\$543.43	\$432.55
336320	Jotto Patriot	425-5627/4143	Focus 14+No Holes	\$613.55	\$488.37

336320	Jotto Patriot	425-5627/4144	Focus 14+No Holes	\$613.55	\$488.37
336320	Jotto Patriot	425-5627/5182	Focus 14+No Holes	\$327.22	\$260.46
336320	Jotto Patriot	425-5627/5215	Focus 14+No Holes	\$397.34	\$316.27
336320	Jotto Patriot	425-5628	Focus14+No Holes	\$153.09	\$121.86
336320	Jotto Patriot	425-5630/4138	Charger 15+ HD MountNo Holes	\$894.02	\$711.61
336320	Jotto Patriot	425-5630/4139	Charger 15+ HD MountNo Holes	\$894.02	\$711.61
336320	Jotto Patriot	425-5631/4138	PI Utility 13-19 HD MountNo Holes	\$894.02	\$711.61
336320	Jotto Patriot	425-5631/4139	PI Utility 13-19 HD MountNo Holes	\$894.02	\$711.61
336320	Jotto Patriot	425-5632/4131	F-150 15-17 (ONLY WORKS WITH 40/20/40 SEAT CONFIGURATION)No Holes	\$543.43	\$432.55
336320	Jotto Patriot	425-5632/4143	F-150 15-17 (ONLY WORKS WITH 40/20/40 SEAT CONFIGURATION)No Holes	\$613.55	\$488.37
336320	Jotto Patriot	425-5632/4144	F-150 15-17 (ONLY WORKS WITH 40/20/40 SEAT CONFIGURATION)No Holes	\$613.55	\$488.37
336320	Jotto Patriot	425-5632/5182	F-150 15-17 (ONLY WORKS WITH 40/20/40 SEAT CONFIGURATION)No Holes	\$327.22	\$260.46
336320	Jotto Patriot	425-5632/5215	F-150 15-17 (ONLY WORKS WITH 40/20/40 SEAT CONFIGURATION)No Holes	\$397.34	\$316.27
336320	Jotto Patriot	425-5634	Cable - Dock - 10" x 12" ABS Plastic (18" Cables)	\$134.40	\$106.98
336320	Jotto Patriot	425-5635	Cable - Dock - 10" x 12" ABS Plastic (20" Cables)	\$134.40	\$106.98
336320	Jotto Patriot	425-5636	Cable - Dock - 10" x 12" ABS Plastic (26.75" Cables)	\$134.40	\$106.98
336320	Jotto Patriot	425-5637	Colorado / Canyon 15+No Holes	\$153.09	\$121.86
336320	Jotto Patriot	425-5638/4131	Colorado / Canyon 15+No Holes	\$543.43	\$432.55
336320	Jotto Patriot	425-5638/4143	Colorado / Canyon 15+No Holes	\$613.55	\$488.37
336320	Jotto Patriot	425-5638/4144	Colorado / Canyon 15+No Holes	\$613.55	\$488.37
336320	Jotto Patriot	425-5638/5182	Colorado / Canyon 15+No Holes	\$327.22	\$260.46
336320	Jotto Patriot	425-5638/5215	Colorado / Canyon 15+No Holes	\$397.34	\$316.27
336320	Jotto Patriot	425-5639	F-150 15-17 (ONLY WORKS WITH 40/20/40 SEAT CONFIGURATION)No Holes	\$153.09	\$121.86
336320	Jotto Patriot	425-5640/4131	Charger 11+ (Police Package Only -- Seat Bolt Mounted)No Holes	\$543.43	\$432.55
336320	Jotto Patriot	425-5640/4143	Charger 11+ (Police Package Only -- Seat Bolt Mounted)No Holes	\$613.55	\$488.37
336320	Jotto Patriot	425-5640/4144	Charger 11+ (Police Package Only -- Seat Bolt Mounted)No Holes	\$613.55	\$488.37
336320	Jotto Patriot	425-5640/5182	Charger 11+ (Police Package Only -- Seat Bolt Mounted)No Holes	\$327.22	\$260.46
336320	Jotto Patriot	425-5640/5215	Charger 11+ (Police Package Only -- Seat Bolt Mounted)No Holes	\$397.34	\$316.27
336320	Jotto Patriot	425-5646/4138	Tahoe 15+ / Silverado 1500 15-18 HD Mount *WARNING! WILL NOT WORK ON VEHICLES WITH OEM CONSOLENo Holes	\$894.02	\$711.61
336320	Jotto Patriot	425-5646/4139	Tahoe 15+ / Silverado 1500 15-18 HD Mount *WARNING! WILL NOT WORK ON VEHICLES WITH OEM CONSOLENo Holes	\$894.02	\$711.61
336320	Jotto Patriot	425-5648/4131	Malibu Classic Limited 2016No Holes	\$543.43	\$432.55
336320	Jotto Patriot	425-5648/4143	Malibu Classic Limited 2016No Holes	\$613.55	\$488.37
336320	Jotto Patriot	425-5648/4144	Malibu Classic Limited 2016No Holes	\$613.55	\$488.37
336320	Jotto Patriot	425-5648/5182	Malibu Classic Limited 2016No Holes	\$327.22	\$260.46
336320	Jotto Patriot	425-5648/5215	Malibu Classic Limited 2016No Holes	\$397.34	\$316.27
336320	Jotto Patriot	425-5649/4138	F-250+ 15-16 HD MountNo Holes	\$894.02	\$711.61
336320	Jotto Patriot	425-5649/4139	F-250+ 15-16 HD MountNo Holes	\$894.02	\$711.61
336320	Jotto Patriot	425-5652/4131	Ram ProMaster City 15+ (Does NOT Fit ProMaster)No Holes	\$543.43	\$432.55
336320	Jotto Patriot	425-5652/4143	Ram ProMaster City 15+ (Does NOT Fit ProMaster)No Holes	\$613.55	\$488.37
336320	Jotto Patriot	425-5652/4144	Ram ProMaster City 15+ (Does NOT Fit ProMaster)No Holes	\$613.55	\$488.37
336320	Jotto Patriot	425-5652/5182	Ram ProMaster City 15+ (Does NOT Fit ProMaster)No Holes	\$327.22	\$260.46
336320	Jotto Patriot	425-5652/5215	Ram ProMaster City 15+ (Does NOT Fit ProMaster)No Holes	\$397.34	\$316.27
336320	Jotto Patriot	425-5653	Ram ProMaster City 15+ (Does NOT Fit ProMaster)No Holes	\$153.09	\$121.86
336320	Jotto Patriot	425-5656	PI Utility 13-19 HD BaseNo Holes	\$280.48	\$223.25
336320	Jotto Patriot	425-5658	Tahoe 15+ / Silverado 1500 15-18 HD Base *WARNING! WILL NOT WORK ON VEHICLES WITH OEM CONSOLENo Holes	\$280.48	\$223.25
336320	Jotto Patriot	425-5667/4131	F-250-550 17+No Holes	\$543.43	\$432.55
336320	Jotto Patriot	425-5667/4143	F-250-550 17+No Holes	\$613.55	\$488.37
336320	Jotto Patriot	425-5667/4144	F-250-550 17+No Holes	\$613.55	\$488.37
336320	Jotto Patriot	425-5667/5182	F-250-550 17+No Holes	\$327.22	\$260.46
336320	Jotto Patriot	425-5667/5215	F-250-550 17+No Holes	\$397.34	\$316.27
336320	Jotto Patriot	425-5668	F-250-550 17+No Holes	\$153.09	\$121.86
336320	Jotto Patriot	425-5669/4138	F-250-550 17+ HD MountNo Holes	\$894.02	\$711.61
336320	Jotto Patriot	425-5669/4139	F-250-550 17+ HD MountNo Holes	\$894.02	\$711.61
336320	Jotto Patriot	425-5670	F-250-550 17+ HD BaseNo Holes	\$280.48	\$223.25
336320	Jotto Patriot	425-5671	Mounting Plate - Panasonic CF20/VESA 75/100Panasonic	\$64.28	\$51.16

336320	Jotto Patriot	425-5676/4131	Flat - UtilityFloor, Universal Mounting	\$574.98	\$457.67
336320	Jotto Patriot	425-5676/4143	Flat - UtilityFloor, Universal Mounting	\$613.55	\$488.37
336320	Jotto Patriot	425-5676/4144	Flat - UtilityFloor, Universal Mounting	\$645.10	\$513.48
336320	Jotto Patriot	425-5676/5182	Flat - UtilityFloor, Universal Mounting	\$358.77	\$285.57
336320	Jotto Patriot	425-5676/5215	Flat - UtilityFloor, Universal Mounting	\$428.89	\$341.38
336320	Jotto Patriot	425-5680/4131	Equinox 17+No Holes	\$543.43	\$432.55
336320	Jotto Patriot	425-5680/4143	Equinox 17+No Holes	\$613.55	\$488.37
336320	Jotto Patriot	425-5680/4144	Equinox 17+No Holes	\$613.55	\$488.37
336320	Jotto Patriot	425-5680/5182	Equinox 17+No Holes	\$327.22	\$260.46
336320	Jotto Patriot	425-5680/5215	Equinox 17+No Holes	\$397.34	\$316.27
336320	Jotto Patriot	425-5682/4131	Expedition SSV 18+No Holes	\$543.43	\$432.55
336320	Jotto Patriot	425-5682/4143	Expedition SSV 18+No Holes	\$613.55	\$488.37
336320	Jotto Patriot	425-5682/4144	Expedition SSV 18+No Holes	\$613.55	\$488.37
336320	Jotto Patriot	425-5682/5182	Expedition SSV 18+No Holes	\$327.22	\$260.46
336320	Jotto Patriot	425-5682/5215	Expedition SSV 18+No Holes	\$397.34	\$316.27
336320	Jotto Patriot	425-5683	Expedition SSV 18+No Holes	\$153.09	\$121.86
336320	Jotto Patriot	425-5684/4131	Traverse 18+No Holes	\$543.43	\$432.55
336320	Jotto Patriot	425-5684/4143	Traverse 18+No Holes	\$613.55	\$488.37
336320	Jotto Patriot	425-5684/4144	Traverse 18+No Holes	\$613.55	\$488.37
336320	Jotto Patriot	425-5684/5182	Traverse 18+No Holes	\$327.22	\$260.46
336320	Jotto Patriot	425-5684/5215	Traverse 18+No Holes	\$397.34	\$316.27
336320	Jotto Patriot	425-5685	Traverse 18+No Holes	\$153.09	\$121.86
336320	Jotto Patriot	425-5687	F-150 15+ HD BaseNo Holes	\$280.48	\$223.25
336320	Jotto Patriot	425-5688	Charger 15+ HD BaseNo Holes	\$280.48	\$223.25
336320	Jotto Patriot	425-5689	PI Sedan 13+ HD BaseNo Holes	\$280.48	\$223.25
336320	Jotto Patriot	425-5691/4131	Silverado "T1" 1500 19+ / Silverado 2500 20+No Holes	\$543.43	\$432.55
336320	Jotto Patriot	425-5691/4143	Silverado "T1" 1500 19+ / Silverado 2500 20+No Holes	\$613.55	\$488.37
336320	Jotto Patriot	425-5691/4144	Silverado "T1" 1500 19+ / Silverado 2500 20+No Holes	\$613.55	\$488.37
336320	Jotto Patriot	425-5691/5182	Silverado "T1" 1500 19+ / Silverado 2500 20+No Holes	\$327.22	\$260.46
336320	Jotto Patriot	425-5691/5215	Silverado "T1" 1500 19+ / Silverado 2500 20+No Holes	\$397.34	\$316.27
336320	Jotto Patriot	425-5692	Silverado "T1" 1500 19+ / Silverado 2500 20+No Holes	\$153.09	\$121.86
336320	Jotto Patriot	425-5693/4138	Silverado "T1" 1500 19+ / Silverado 2500 20+ HD MountNo Holes	\$894.02	\$711.61
336320	Jotto Patriot	425-5693/4139	Silverado "T1" 1500 19+ / Silverado 2500 20+ HD MountNo Holes	\$894.02	\$711.61
336320	Jotto Patriot	425-5694	Silverado "T1" 1500 19+ / Silverado 2500 20+ HD BaseNo Holes	\$280.48	\$223.25
336320	Jotto Patriot	425-5698/4131	Ram DT 19-20 ***Will NOT Fit 2019+ DS (SSV)*** - IN HOUSE	\$543.43	\$432.55
336320	Jotto Patriot	425-5698/4143	Ram DT 19-20 ***Will NOT Fit 2019+ DS (SSV)*** - IN HOUSE	\$613.55	\$488.37
336320	Jotto Patriot	425-5698/4144	Ram DT 19-20 ***Will NOT Fit 2019+ DS (SSV)*** - IN HOUSE	\$613.55	\$488.37
336320	Jotto Patriot	425-5698/5182	Ram DT 19-20 ***Will NOT Fit 2019+ DS (SSV)*** - IN HOUSE	\$327.22	\$260.46
336320	Jotto Patriot	425-5698/5215	Ram DT 19-20 ***Will NOT Fit 2019+ DS (SSV)*** - IN HOUSE	\$397.34	\$316.27
336320	Jotto Patriot	425-5699/4131	Console Side Mount - PI Utility 2020+ (Fits 425-6505, 425-6508 and 425-6512)Console Side Mounted	\$508.37	\$404.65
336320	Jotto Patriot	425-5699/4143	Console Side Mount - PI Utility 2020+ (Fits 425-6505, 425-6508 and 425-6512)Console Side Mounted	\$578.49	\$460.46
336320	Jotto Patriot	425-5699/4144	Console Side Mount - PI Utility 2020+ (Fits 425-6505, 425-6508 and 425-6512)Console Side Mounted	\$578.49	\$460.46
336320	Jotto Patriot	425-5699/5182	Console Side Mount - PI Utility 2020+ (Fits 425-6505, 425-6508 and 425-6512)Console Side Mounted	\$292.16	\$232.55
336320	Jotto Patriot	425-5699/5215	Console Side Mount - PI Utility 2020+ (Fits 425-6505, 425-6508 and 425-6512)Console Side Mounted	\$362.28	\$288.36
336320	Jotto Patriot	425-5701/4131	Escape 2020+	\$543.43	\$432.55
336320	Jotto Patriot	425-5701/4143	Escape 2020+	\$613.55	\$488.37
336320	Jotto Patriot	425-5701/4144	Escape 2020+	\$613.55	\$488.37
336320	Jotto Patriot	425-5701/5182	Escape 2020+	\$327.22	\$260.46
336320	Jotto Patriot	425-5701/5215	Escape 2020+	\$397.34	\$316.27
336320	Jotto Patriot	425-5999	Accessory - Screen Holder - ONLY WORKS WITH ACD DESKTOP (425-5215)	\$51.42	\$40.93
336320	Jotto Patriot	425-6010	Short Stack (9" FP)	\$202.18	\$160.93
336320	Jotto Patriot	425-6011	Medium (12" FP)	\$233.73	\$186.04
336320	Jotto Patriot	425-6012	Large ( 15" FP)	\$252.43	\$200.93
336320	Jotto Patriot	425-6015	Short Stack (9" FP, 28" FLP) - Crown Victoria 97-12	\$310.86	\$247.44
336320	Jotto Patriot	425-6016	Medium (12" FP, 28" FLP) - Crown Victoria 97-12	\$342.42	\$272.56
336320	Jotto Patriot	425-6017	Large ( 15" FP, 28" FLP) - Crown Victoria 97-12	\$361.12	\$287.44
336320	Jotto Patriot	425-6020	Crown Victoria 97-12 (12" FLP - Front Legs)	\$102.84	\$81.86
336320	Jotto Patriot	425-6022	Silverado 1500 14-18 / Tahoe 15+ / Silverado 2500 15-19 (28" FLP - Front/Rear Legs)	\$184.64	\$146.97
336320	Jotto Patriot	425-6023	Crown Victoria 97-12 (28" FLP - Front Legs)	\$127.39	\$101.40

336320	Jotto Patriot	425-6025	Crown Victoria 97-12 Climate Control, (12" FP/28" FLP)	\$487.33	\$387.90
336320	Jotto Patriot	425-6026	Crown Victoria 97-12 Vertical, (12" FP/28" FLP)	\$437.07	\$347.89
336320	Jotto Patriot	425-6027	Crown Victoria 97-12 Climate Control, (12" FP)	\$361.12	\$287.44
336320	Jotto Patriot	425-6028	Crown Victoria 97-12 Vertical, (12" FP)	\$310.86	\$247.44
336320	Jotto Patriot	425-6029	Storage Compartment - Armrest, Lid ( 10" x 4.5" x 8.5")	\$154.27	\$122.79
336320	Jotto Patriot	425-6030	Storage Compartment (8" x 4.5" x 8.5")	\$129.72	\$103.25
336320	Jotto Patriot	425-6031	Storage Compartment - Lock (8.5" x 4.5" x 8.5")	\$154.27	\$122.79
336320	Jotto Patriot	425-6035	Mic Clip - w/ Plate	\$23.37	\$18.60
336320	Jotto Patriot	425-6036	Storage Compartment - Armrest, Adjustable (8" x 4.5" x 8.5")	\$184.64	\$146.97
336320	Jotto Patriot	425-6038	Cup Holder - Center Console ( 2.75" x 4" x 8.75")	\$82.97	\$66.04
336320	Jotto Patriot	425-6048	0.5" - Blank	\$16.36	\$13.02
336320	Jotto Patriot	425-6049	1" - Blank	\$16.36	\$13.02
336320	Jotto Patriot	425-6050	1.5" - Blank	\$16.36	\$13.02
336320	Jotto Patriot	425-6051	2" - Blank	\$16.36	\$13.02
336320	Jotto Patriot	425-6052	2.5" - Blank	\$16.36	\$13.02
336320	Jotto Patriot	425-6053	3" - Blank	\$16.36	\$13.02
336320	Jotto Patriot	425-6056	4.5" - Trim Piece for Ford Factory Radio	\$21.03	\$16.74
336320	Jotto Patriot	425-6057	2" - 7 knock - out toggle switches/ 1 power outlet knock -out for 12V	\$28.05	\$22.33
336320	Jotto Patriot	425-6058	3"-3 power knockouts w/5 Switch knock-outs	\$28.05	\$22.33
336320	Jotto Patriot	425-6059	Silverado 1500 14-19 / Tahoe 15+ / Silverado 2500 15-19 Floor Plate Legs (Front/Rear Legs)	\$102.84	\$81.86
336320	Jotto Patriot	425-6060	Spectra/AstroSpectra/XTL5000 A/W 9 w/1 DEK(Direct Entry Keypad)	\$54.93	\$43.72
336320	Jotto Patriot	425-6062	Dual Radio,	\$43.24	\$34.42
336320	Jotto Patriot	425-6063	MCS2000 Model 2/3 (DASH MOUNT)	\$43.24	\$34.42
336320	Jotto Patriot	425-6064	Pro 2067 Scanner (w/ 2 LG Plst. washers)	\$43.24	\$34.42
336320	Jotto Patriot	425-6065	Spectra/AstroSpectra/XTL5000 A/W 9 w/2 DEK(Direct Entry Keypad)	\$54.93	\$43.72
336320	Jotto Patriot	425-6066	Spectra/AstroSpectra/XTL5000 A9/W9 MaraTrac	\$43.24	\$34.42
336320	Jotto Patriot	425-6068	VX-2100/2200, 4500/4600 (for 2" version use 425-6302)	\$43.24	\$34.42
336320	Jotto Patriot	425-6069	VCON (Round Buttons)	\$43.24	\$34.42
336320	Jotto Patriot	425-6071	Soft-Touch (RLS/3999), RLS 3997, RLS 3998	\$43.24	\$34.42
336320	Jotto Patriot	425-6073	Arrowstik	\$43.24	\$34.42
336320	Jotto Patriot	425-6075	SMC Arrowstik Controller, SMC16, SMC56	\$43.24	\$34.42
336320	Jotto Patriot	425-6076	PA300	\$43.24	\$34.42
336320	Jotto Patriot	425-6077	SW300/400	\$43.24	\$34.42
336320	Jotto Patriot	425-6078	LCS 5, LCS 7	\$43.24	\$34.42
336320	Jotto Patriot	425-6079	SMC 1/5 (2" version of 425-6075)	\$43.24	\$34.42
336320	Jotto Patriot	425-6080	TK730,TK790,TK890,TK830(DASH MOUNT)	\$43.24	\$34.42
336320	Jotto Patriot	425-6081	KW (UNKNOWN)	\$43.24	\$34.42
336320	Jotto Patriot	425-6082	TK760, TK840, TK880	\$43.24	\$34.42
336320	Jotto Patriot	425-6083	TK6110	\$43.24	\$34.42
336320	Jotto Patriot	425-6085	TM Delta,UTM4, Omega 9000	\$43.24	\$34.42
336320	Jotto Patriot	425-6086	480 K Controller (Older Model)	\$43.24	\$34.42
336320	Jotto Patriot	425-6090	Syntec 1 (Remote Head)	\$43.24	\$34.42
336320	Jotto Patriot	425-6091	Titan	\$43.24	\$34.42
336320	Jotto Patriot	425-6093	Syntec 1 or 70-341B (old)	\$43.24	\$34.42
336320	Jotto Patriot	425-6094	70-1440	\$43.24	\$34.42
336320	Jotto Patriot	425-6095	VX-4200,VX4104, VX4204, VX-4107, VX-4207	\$43.24	\$34.42
336320	Jotto Patriot	425-6096	MPC01, 295HFS A5/6, 295SLSA6 Siren Control	\$43.24	\$34.42
336320	Jotto Patriot	425-6097	PCC-HD1 & PCC-HD2, 295SLSA1	\$43.24	\$34.42
336320	Jotto Patriot	425-6099	PCCS9R/N -TACTRL1A, TADCTL1, PCS9	\$43.24	\$34.42
336320	Jotto Patriot	425-6100	PCC-6R, PCC-10, 6P4, EPSL1 (Galls SE076)	\$43.24	\$34.42
336320	Jotto Patriot	425-6101	CenCom, MPC-03, 295SDA/SSA	\$43.24	\$34.42
336320	Jotto Patriot	425-6103	MasterCom (Square Buttons)	\$43.24	\$34.42
336320	Jotto Patriot	425-6104	Pro 2096 Scanner	\$43.24	\$34.42
336320	Jotto Patriot	425-6105	Pro 2066	\$43.24	\$34.42
336320	Jotto Patriot	425-6106	MVS	\$43.24	\$34.42
336320	Jotto Patriot	425-6107	MVS-Remote	\$43.24	\$34.42
336320	Jotto Patriot	425-6108	S825 Ranger- Old	\$43.24	\$34.42
336320	Jotto Patriot	425-6109	Orion (REMOTE)	\$43.24	\$34.42
336320	Jotto Patriot	425-6110	ICOM F121, F221	\$43.24	\$34.42
336320	Jotto Patriot	425-6113	F1721/1821/2721/2821	\$43.24	\$34.42
336320	Jotto Patriot	425-6114	2" - Four Vertical Square Holes (Carling Switches)	\$28.05	\$22.33
336320	Jotto Patriot	425-6115	#05-6000, #05-6040, #05-5540	\$43.24	\$34.42
336320	Jotto Patriot	425-6116	295SL100	\$43.24	\$34.42

336320	Jotto Patriot	425-6117	XTL 2500 (DASH MOUNT ONLY)	\$43.24	\$34.42
336320	Jotto Patriot	425-6118	SA450	\$43.24	\$34.42
336320	Jotto Patriot	425-6119	FACEPLATE MOTOROLA VRM500	\$43.24	\$34.42
336320	Jotto Patriot	425-6121	Pro 1000 DS/Eagle Series	\$43.24	\$34.42
336320	Jotto Patriot	425-6122	Golden Eagle/Silver Eagle	\$43.24	\$34.42
336320	Jotto Patriot	425-6124	Durango '07-'09 (15" FP)	\$473.31	\$376.74
336320	Jotto Patriot	425-6125	Dual SL Display Monitor	\$43.24	\$34.42
336320	Jotto Patriot	425-6126	Pro 510 XL Scanner	\$43.24	\$34.42
336320	Jotto Patriot	425-6127	320 Radio	\$43.24	\$34.42
336320	Jotto Patriot	425-6128	BC350A, BCT 7, BC350 C (If a 2" plate is needed 425-6125) BEST FIT	\$43.24	\$34.42
336320	Jotto Patriot	425-6129	Orion (DASH MOUNT) Loose fit for tilt	\$43.24	\$34.42
336320	Jotto Patriot	425-6130	PM1500 Radio	\$43.24	\$34.42
336320	Jotto Patriot	425-6131	Flash Back FB04-M	\$43.24	\$34.42
336320	Jotto Patriot	425-6132	SM4450, SM4150	\$43.24	\$34.42
336320	Jotto Patriot	425-6133	F-250+ 08-16 ( 28" FLP - Front/Rear legs)	\$223.21	\$177.67
336320	Jotto Patriot	425-6141	APX1500/APX4500/6500 (DASH MOUNT)	\$43.24	\$34.42
336320	Jotto Patriot	425-6146	7011, 1011, 2011	\$43.24	\$34.42
336320	Jotto Patriot	425-6147	3 Position Light Controller	\$43.24	\$34.42
336320	Jotto Patriot	425-6148	Plus Model 2	\$43.24	\$34.42
336320	Jotto Patriot	425-6149	LH650 / 960	\$43.24	\$34.42
336320	Jotto Patriot	425-6150	IntelliSwitch 990-993	\$43.24	\$34.42
336320	Jotto Patriot	425-6151	GS150 14 (SKO079) ST105 (SK122)	\$43.24	\$34.42
336320	Jotto Patriot	425-6152	ST-280 (SK126)	\$43.24	\$34.42
336320	Jotto Patriot	425-6159	AK-12 w/SmoothGlide (12" FP) w/ACD Desktop, Universal	\$875.61	\$696.96
336320	Jotto Patriot	425-6162	Caprice 14+ (14" FP)	\$303.85	\$241.86
336320	Jotto Patriot	425-6164	FP Assy, 2" Blank w/ 2.1A USB x2 & 12V Outlets x2	\$111.03	\$88.38
336320	Jotto Patriot	425-6166	TD 7700 Directional Stick (old style)	\$43.24	\$34.42
336320	Jotto Patriot	425-6167	SB 4020/4040	\$43.24	\$34.42
336320	Jotto Patriot	425-6168	SA-400	\$43.24	\$34.42
336320	Jotto Patriot	425-6169	LCS 800 with Flange	\$43.24	\$34.42
336320	Jotto Patriot	425-6170	SA400	\$43.24	\$34.42
336320	Jotto Patriot	425-6171	SS670	\$43.24	\$34.42
336320	Jotto Patriot	425-6175	Charger 11+ CC/CD Console (10" FP)	\$465.12	\$370.22
336320	Jotto Patriot	425-6177	Expedition 16-17 (28" FLP - Front/Rear Legs)	\$184.64	\$146.97
336320	Jotto Patriot	425-6178	ETSA380R/ETSA481R	\$43.24	\$34.42
336320	Jotto Patriot	425-6180	EPSL4/EPSL2S7	\$43.24	\$34.42
336320	Jotto Patriot	425-6181	GS-230 (SK106), GS-207 (SK082), GS-204(SK081)	\$43.24	\$34.42
336320	Jotto Patriot	425-6182	RDS-RK	\$43.24	\$34.42
336320	Jotto Patriot	425-6184	S-SA500-01	\$43.24	\$34.42
336320	Jotto Patriot	425-6185	SA 500-007/SS700	\$43.24	\$34.42
336320	Jotto Patriot	425-6190	Expedition 07-11 Console Insert (2 Piece 10" FP)	\$373.97	\$297.67
336320	Jotto Patriot	425-6193	PI Utility 13-15 (16" FP - 12" top 4" bottom)	\$490.83	\$390.69
336320	Jotto Patriot	425-6200	Durango 99-03 (28" FLP)	\$174.13	\$138.60
336320	Jotto Patriot	425-6203	Universal Floor/Drill Down (28" FLP)	\$174.13	\$138.60
336320	Jotto Patriot	425-6204	Tahoe / Suburban / Silverado 2500+ / 00-14 / Silverado 1500 / Sierra 1500 00-13 (28" FLP - Front/Rear Legs)	\$174.13	\$138.60
336320	Jotto Patriot	425-6205	Cup Holder, Dual External (4.045 x 5.088 x 9.6)	\$64.28	\$51.16
336320	Jotto Patriot	425-6206	Expedition 03-15 (28" FLP - Front/Rear Legs)	\$174.13	\$138.60
336320	Jotto Patriot	425-6210	TD 92 LED Directional Stick (new style)	\$43.24	\$34.42
336320	Jotto Patriot	425-6213	XPR 4350/4380/4550/4580/5350/5550 Radio (REMOTE HEAD ONLY) See 425-6291 for DASH MOUNT	\$43.24	\$34.42
336320	Jotto Patriot	425-6216	Storage Compartment - Armrest, Adjustable, Lock (8.5" x 4.5" 8.5")	\$215.03	\$171.16
336320	Jotto Patriot	425-6229	Expedition 03-15 Floor Plate Legs (Front/Rear Legs)	\$119.21	\$94.89
336320	Jotto Patriot	425-6230	Tahoe 00-14/Suburban/CK 03+ Floor Plate Legs (Front/Rear Legs)	\$119.21	\$94.89
336320	Jotto Patriot	425-6232	Lazy L (18" FP)	\$379.82	\$302.33
336320	Jotto Patriot	425-6234	Lazy L (18" FP, 28"FLP) - Crown Victoria 97-12	\$552.77	\$439.99
336320	Jotto Patriot	425-6236	VehiclePro 400	\$43.24	\$34.42
336320	Jotto Patriot	425-6242	Trailer Brake Plate -F-250 Console	\$43.24	\$34.42
336320	Jotto Patriot	425-6246	Crown Victoria 97-12 Floor Plate Leg - (Front Legs)	\$70.12	\$55.81
336320	Jotto Patriot	425-6248	EMS Console -Utility Package #1 (12" Console 12"Box w/2 dividers/ 6" Box), Universal	\$635.74	\$506.03
336320	Jotto Patriot	425-6249	EMS Console -Utility Package #2 (12" Console 12"Box w/2 dividers/ 6" Box w/ Lid & Lock), Universal	\$718.73	\$572.09
336320	Jotto Patriot	425-6251	Console, 12" EMS	\$315.54	\$251.16
336320	Jotto Patriot	425-6253	20/20 DVR	\$43.24	\$34.42

336320	Jotto Patriot	425-6256	GLB 3200	\$43.24	\$34.42
336320	Jotto Patriot	425-6257	Model 3995 Mini-RLS, NASCC	\$43.24	\$34.42
336320	Jotto Patriot	425-6258	Omega 8001 Remote	\$43.24	\$34.42
336320	Jotto Patriot	425-6260	Armrest - Upper Structure (7.75" x 8" x 8")	\$73.63	\$58.61
336320	Jotto Patriot	425-6266	AK-16 w/SmoothGlide (16" FP) - w/ACD Desktop	\$1,021.18	\$812.83
336320	Jotto Patriot	425-6268	Tahoe 15+ with Locking Lid (20" FP/28" FLP)	\$876.49	\$697.66
336320	Jotto Patriot	425-6271	F250-F550 2012+ - Dash Mount (10" FP)	\$444.09	\$353.48
336320	Jotto Patriot	425-6272	XG-25M (DASH MOUNT)	\$43.24	\$34.42
336320	Jotto Patriot	425-6280	PW6-HD	\$43.24	\$34.42
336320	Jotto Patriot	425-6281	ETSA48xRSR	\$43.24	\$34.42
336320	Jotto Patriot	425-6284	Typhoon Full Function Siren	\$43.24	\$34.42
336320	Jotto Patriot	425-6285	K9 Heat Alarm, CH-2520	\$43.24	\$34.42
336320	Jotto Patriot	425-6286	#30-2400	\$43.24	\$34.42
336320	Jotto Patriot	425-6287	Pathfinder	\$43.24	\$34.42
336320	Jotto Patriot	425-6291	XPR 4350/4380/4550/4580/5350/5550 Radio (DASH MOUNT ONLY) See 425-6213 for REMOTE HEAD	\$43.24	\$34.42
336320	Jotto Patriot	425-6293	Secure Digital (SD) DVR Controller (old style)	\$43.24	\$34.42
336320	Jotto Patriot	425-6294	SB 4020T	\$43.24	\$34.42
336320	Jotto Patriot	425-6295	XTL5000 O5 (REMOTE HEAD)/APX 7500 O5 HEAD/APX6500/4500 (REMOTE HEAD)	\$43.24	\$34.42
336320	Jotto Patriot	425-6296	APX 7500 O9 Control Head	\$54.93	\$43.72
336320	Jotto Patriot	425-6297	Pro 2055 Scanner, Pro 197 Scanner	\$43.24	\$34.42
336320	Jotto Patriot	425-6298	XTL 2500 (REMOTE HEAD ONLY)	\$43.24	\$34.42
336320	Jotto Patriot	425-6300	Fits (3) TK880's stacked on top of each other	\$43.24	\$34.42
336320	Jotto Patriot	425-6301	TK930	\$43.24	\$34.42
336320	Jotto Patriot	425-6302	VRM650	\$43.24	\$34.42
336320	Jotto Patriot	425-6303	CDM1250 CDM750, CDM1550 (DASH MOUNT ONLY) See 425-6441 for REMOTE HEAD	\$43.24	\$34.42
336320	Jotto Patriot	425-6304	TK7150/8150	\$43.24	\$34.42
336320	Jotto Patriot	425-6305	XTR REMOTE HEAD 70-1340B	\$43.24	\$34.42
336320	Jotto Patriot	425-6306	Syntor X Control Head	\$43.24	\$34.42
336320	Jotto Patriot	425-6307	VX3000-3200 (DASH MOUNT)	\$43.24	\$34.42
336320	Jotto Patriot	425-6308	Summit Remote, 5300	\$43.24	\$34.42
336320	Jotto Patriot	425-6309	ID Control 5000	\$43.24	\$34.42
336320	Jotto Patriot	425-6310	Single Entry Keypad (DEK box)	\$43.24	\$34.42
336320	Jotto Patriot	425-6311	Double Entry Keypad (2 DEK boxes)	\$43.24	\$34.42
336320	Jotto Patriot	425-6312	AS4500	\$43.24	\$34.42
336320	Jotto Patriot	425-6313	HT-1000 Portable Charger	\$43.24	\$34.42
336320	Jotto Patriot	425-6315	Mitrek	\$43.24	\$34.42
336320	Jotto Patriot	425-6316	#30-3104, LED Directional Stick Controller, Arrowstick Controller, Chameleon Signal Stick Controller	\$43.24	\$34.42
336320	Jotto Patriot	425-6317	#05-4040, #05-4000	\$43.24	\$34.42
336320	Jotto Patriot	425-6318	SVR - 200	\$43.24	\$34.42
336320	Jotto Patriot	425-6319	EMV4990A	\$43.24	\$34.42
336320	Jotto Patriot	425-6320	ConvertaCom	\$43.24	\$34.42
336320	Jotto Patriot	425-6321	MCS 2000 Model 2/3 (REMOTE HEAD)	\$43.24	\$34.42
336320	Jotto Patriot	425-6322	SMV4016	\$43.24	\$34.42
336320	Jotto Patriot	425-6325	TK730,TK790,TK890,TK830(REMOTE HEAD)	\$43.24	\$34.42
336320	Jotto Patriot	425-6326	Kustom Signal Eyewitness	\$43.24	\$34.42
336320	Jotto Patriot	425-6328	#KES -3 Speaker (New)	\$43.24	\$34.42
336320	Jotto Patriot	425-6329	VX-4000/VX5500/VX6000 (DASH MOUNT)	\$43.24	\$34.42
336320	Jotto Patriot	425-6330	VX-4000/VX5500/VX6000 (REMOTE HEAD)	\$43.24	\$34.42
336320	Jotto Patriot	425-6331	PCC6W & PCC10W Switch Box	\$43.24	\$34.42
336320	Jotto Patriot	425-6332	LCS 850	\$43.24	\$34.42
336320	Jotto Patriot	425-6333	Orion (DASH MOUNT)	\$43.24	\$34.42
336320	Jotto Patriot	425-6334	FMD, 16 Plus	\$43.24	\$34.42
336320	Jotto Patriot	425-6335	3" - 4 knock -out toggle switches (round)	\$30.39	\$24.19
336320	Jotto Patriot	425-6336	TK760, TK840, TK880, TK980 (2" version of 425-6082)	\$43.24	\$34.42
336320	Jotto Patriot	425-6340	3" - 5 sq. Switch, 2 Cig Lighter, 1 CV Trunk Button Knockouts	\$28.05	\$22.33
336320	Jotto Patriot	425-6341	Magnum F2 Control	\$43.24	\$34.42
336320	Jotto Patriot	425-6342	Spectra/AstroSpectra/XTL5000 A/W 4,5,7 (REMOTE HEAD)	\$43.24	\$34.42
336320	Jotto Patriot	425-6343	940/940R Siren (DASH/REMOTE)/948L-DCP	\$43.24	\$34.42
336320	Jotto Patriot	425-6345	Face Plate - 3" Locking Box (3" x 6.75" x 9.074")	\$160.10	\$127.43
336320	Jotto Patriot	425-6346	Plus Model 3	\$43.24	\$34.42
336320	Jotto Patriot	425-6347	500M, Ericson Scanner	\$43.24	\$34.42
336320	Jotto Patriot	425-6349	SA500 Siren	\$43.24	\$34.42
336320	Jotto Patriot	425-6350	2" - Three 7/8" Hole Power Mounting Plate for Chevy	\$21.03	\$16.74

336320	Jotto Patriot	425-6351	Digital Mobile Control Head CH-103, M-803 (REMOTE HEAD)	\$43.24	\$34.42
336320	Jotto Patriot	425-6353	TD77-2 Star Stik Controller	\$43.24	\$34.42
336320	Jotto Patriot	425-6354	Omega 5000	\$43.24	\$34.42
336320	Jotto Patriot	425-6355	Plus Model 1	\$43.24	\$34.42
336320	Jotto Patriot	425-6356	Spectra/AstroSpectra/XTL5000 A/W 4,5,7 w/1 DEK(Direct Entry Keyboard)	\$43.24	\$34.42
336320	Jotto Patriot	425-6357	FT-7100	\$43.24	\$34.42
336320	Jotto Patriot	425-6358	Face Plate - Armrest - 3"	\$45.58	\$36.28
336320	Jotto Patriot	425-6359	4" - Blank	\$16.36	\$13.02
336320	Jotto Patriot	425-6362	TK 7180 / 8180	\$43.24	\$34.42
336320	Jotto Patriot	425-6363	PA640	\$43.24	\$34.42
336320	Jotto Patriot	425-6364	Genesis II	\$43.24	\$34.42
336320	Jotto Patriot	425-6365	Arrowstik,SDPD	\$43.24	\$34.42
336320	Jotto Patriot	425-6366	Intimidator	\$43.24	\$34.42
336320	Jotto Patriot	425-6367	1 Switch, 3 Power Plate	\$28.05	\$22.33
336320	Jotto Patriot	425-6368	M7200/M7300, XG75 CH721 (REMOTE HEAD)	\$43.24	\$34.42
336320	Jotto Patriot	425-6370	Mobile Eye	\$43.24	\$34.42
336320	Jotto Patriot	425-6384	Charger 12+ CC/CD Accessory Adapter Plate (ONLY Fits 425-6175)	\$146.09	\$116.28
336320	Jotto Patriot	425-6385	Explorer 11+ (12" FP)	\$525.89	\$418.59
336320	Jotto Patriot	425-6387	SC-411 Siren	\$43.24	\$34.42
336320	Jotto Patriot	425-6389	Unity XG-100M	\$43.24	\$34.42
336320	Jotto Patriot	425-6391	MD782G	\$43.24	\$34.42
336320	Jotto Patriot	425-6392	4200 & 2200 Control Head	\$43.24	\$34.42
336320	Jotto Patriot	425-6393	Mobile Vision Monitor	\$43.24	\$34.42
336320	Jotto Patriot	425-6394	4RE DVR	\$43.24	\$34.42
336320	Jotto Patriot	425-6395	F-250 08-16 Floor Plate Legs (Front/Rear Legs)	\$147.25	\$117.21
336320	Jotto Patriot	425-6401	GMH5992X Radio	\$43.24	\$34.42
336320	Jotto Patriot	425-6402	MSAT G2	\$43.24	\$34.42
336320	Jotto Patriot	425-6403	ETSA300MF/ETSA100E/ETSA380MF/ETSA481C	\$43.24	\$34.42
336320	Jotto Patriot	425-6404	Signal Master Controller Model # 330104 & 331105	\$43.24	\$34.42
336320	Jotto Patriot	425-6405	2" 4 knock-out toggle switches (round)	\$28.05	\$22.33
336320	Jotto Patriot	425-6408	Z3 CONTROL HEAD	\$43.24	\$34.42
336320	Jotto Patriot	425-6410	SC-409, Commander	\$43.24	\$34.42
336320	Jotto Patriot	425-6411	Armrest - Adjustable (4.125" x 9" x 11")	\$135.57	\$107.91
336320	Jotto Patriot	425-6412	Smart Siren Platinum Series, PA300-CN	\$43.24	\$34.42
336320	Jotto Patriot	425-6416	AK-7 w/SmoothGlide (7" FP) PI Sedan 13+ - w/ACD Desktop	\$920.89	\$733.00
336320	Jotto Patriot	425-6421	#05-4004, #05-4044 4 Position Switch Box	\$43.24	\$34.42
336320	Jotto Patriot	425-6428	AK-7 w/SmoothGlide (7" FP) PI Utility 13+ - w/ACD Desktop	\$920.89	\$733.00
336320	Jotto Patriot	425-6437	PCC S9RW Switch Box	\$43.24	\$34.42
336320	Jotto Patriot	425-6438	KNG M150	\$43.24	\$34.42
336320	Jotto Patriot	425-6439	MT680	\$43.24	\$34.42
336320	Jotto Patriot	425-6440	TM628-H	\$43.24	\$34.42
336320	Jotto Patriot	425-6441	CDM1250 CDM750, CDM1550 (REMOTE HEAD ONLY) See 425-6303 for DASH MOUNT	\$43.24	\$34.42
336320	Jotto Patriot	425-6442	XCEL Siren	\$43.24	\$34.42
336320	Jotto Patriot	425-6443	IC-F5061/F6061	\$43.24	\$34.42
336320	Jotto Patriot	425-6445	Standard Wide Body with Locking Lid (20" FP)	\$730.41	\$581.38
336320	Jotto Patriot	425-6447	2" - 15+ Tahoe OEM USB & (2) 12V Openings (Red Rubber Cap)	\$30.39	\$24.19
336320	Jotto Patriot	425-6451	AK-12 w/SmoothGlide (12" FP) - w/GK-LedCo Plate	\$798.19	\$635.34
336320	Jotto Patriot	425-6451/4138	AK-12 w/SmoothGlide (12" FP) - w/A-MOD Desktop	\$1,185.30	\$943.46
336320	Jotto Patriot	425-6452	AK-16 w/SmoothGlide (16"FP) - w/GK-LedCo Plate	\$943.76	\$751.20
336320	Jotto Patriot	425-6452/4138	AK-16 w/SmoothGlide (16" FP) - w/A-MOD Desktop	\$1,330.88	\$1,059.34
336320	Jotto Patriot	425-6453	AK7 w/SmoothGlide (7" FP) - PI Sedan 13+ - w/GK-LedCo Plate	\$843.48	\$671.38
336320	Jotto Patriot	425-6453/4138	AK-7 w/SmoothGlide (7" FP) PI Sedan 13+ - w/A-MOD Desktop	\$1,230.59	\$979.51
336320	Jotto Patriot	425-6454	AK-7 w/SmoothGlide (7" FP) PI Utility 13+ -w/GK LedCo Plate	\$843.48	\$671.38
336320	Jotto Patriot	425-6454/4138	AK-7 w/SmoothGlide (7" FP) PI Utility 13+ - w/A-MOD Desktop	\$1,230.59	\$979.51
336320	Jotto Patriot	425-6456	AK-7 w/SmoothGlide (7"FP) Charger 11+ - w/GK LedCo Plate	\$843.48	\$671.38
336320	Jotto Patriot	425-6456/4138	AK-7 w/SmoothGlide (7" FP) Charger 11+ - w/A-MOD Desktop	\$1,230.59	\$979.51
336320	Jotto Patriot	425-6460	Caprice 14+ (15" FP - 3" top 12" bottom)	\$399.68	\$318.13
336320	Jotto Patriot	425-6467	NX-5000 KCH-20R Featured (Remote Head)	\$43.24	\$34.42
336320	Jotto Patriot	425-6469	Genesis II Select	\$43.24	\$34.42
336320	Jotto Patriot	425-6473	PI Utility 16+ IPBCC Console (14" FP)	\$671.98	\$534.88
336320	Jotto Patriot	425-6478	PI Utility 16+ (16" FP - 12" top 4" bottom)	\$490.83	\$390.69
336320	Jotto Patriot	425-6479	PI Utility 16+ Max Depth with Dual ABS Cup Holder (16" FP - 12" depth)	\$701.19	\$558.13

336320	Jotto Patriot	425-6480	Silverado 15+ Vertical Dash Mount, (9" FP)	\$233.73	\$186.04
336320	Jotto Patriot	425-6481	TM9400 (DASH MOUNT)	\$43.24	\$34.42
336320	Jotto Patriot	425-6483	Charger 16+ with 12.1 UConnect (16" FP)	\$635.74	\$506.03
336320	Jotto Patriot	425-6485	Charger 16+ IPBCC Console (15" FP)	\$555.11	\$441.85
336320	Jotto Patriot	425-6486	HD4SD MDVR	\$43.24	\$34.42
336320	Jotto Patriot	425-6489	TM9400 (REMOTE HEAD)	\$43.24	\$34.42
336320	Jotto Patriot	425-6490	2" - Charger OEM 12V Openings	\$30.39	\$24.19
336320	Jotto Patriot	425-6491	Wide Body AR/ZRT Console (20" FP), Universal	\$1,001.70	\$797.32
336320	Jotto Patriot	425-6497	3" - 13-19 PI Utility OEM USB & (2) 12V Openings (Red Rubber Cap)	\$30.39	\$24.19
336320	Jotto Patriot	425-6500	F-150 SSV/Police Responder 18-20 with Locking Lid (20" FP/ 28" FLP), Ford	\$918.23	\$730.88
336320	Jotto Patriot	425-6501	F-250 17+ (28" FLP - Front/Rear Legs)	\$223.21	\$177.67
336320	Jotto Patriot	425-6502	F-150 SSV/Police Responder 18+ Floor Plate Legs (Front/Rear Legs)	\$119.21	\$94.89
336320	Jotto Patriot	425-6505	PI Utility 2020+ Contour Console (20" FP - 6" top 14" bottom)	\$504.00	\$401.17
336320	Jotto Patriot	425-6508	PI Utility 2020+ IPBCC Console (14" FP)	\$698.25	\$555.79
336320	Jotto Patriot	425-6509	RM7535 / KCH-20RV (Remote Head)	\$43.24	\$34.42
336320	Jotto Patriot	425-6511	PI Utility 2020+ Contour Console (3" Dash Console)	\$252.00	\$200.58
336320	Jotto Patriot	425-6512	PI Utility 2020+ Max Depth (20" FP)	\$656.25	\$522.36
336320	Jotto Patriot	425-6522	F250-550 11+ w/ 4x4 Shifter Cutout (10" FP)	\$468.63	\$373.02
336320	Jotto Patriot	425-6533	Arbitrator Video Controller	\$43.24	\$34.42
336320	Jotto Patriot	425-6538	AK-7 w/SmoothGlide (7" FP) Charger 11+ - w/ACD Desktop	\$920.89	\$733.00
336320	Jotto Patriot	425-6541	Olympus Control Head	\$43.24	\$34.42
336320	Jotto Patriot	425-6542	Olympus 16X Monitor Display	\$56.09	\$44.65
336320	Jotto Patriot	425-6543	7" Faceplate for Zebra ZQ520 4" Printer	\$166.95	\$132.89
336320	Jotto Patriot	425-6544	7" Faceplate for Brother RJ4030 4" Printer	\$166.95	\$132.89
336320	Jotto Patriot	425-6547	Littlite UV Viewer (UVV) - Assembly, (2) 12V Outlets & UVV in 3" Faceplate (Plastic Cap)	\$208.95	\$166.32
336320	Jotto Patriot	425-6554	Wide Body (IPB) Console (14" FP)	\$829.50	\$660.26
336320	Jotto Patriot	425-6560	Defend IR Security Solution FP (2")	\$295.00	\$234.81
336320	Jotto Patriot	425-6614	PI Sedan 13+ (28" FLP - Front/Rear Legs)	\$174.13	\$138.60
336320	Jotto Patriot	425-6615	PI Utility 13-19 (28" FLP - Front/Rear Legs)	\$174.13	\$138.60
336320	Jotto Patriot	425-6616	Locking Lid Upgrade Kit - Tahoe 12-14 Contour Console (425-6418)	\$87.65	\$69.77
336320	Jotto Patriot	425-6619	XG-75M / M7300 / M5300 (Dash Mount)	\$43.24	\$34.42
336320	Jotto Patriot	425-6621	Tahoe 15+ IPBCC with Locking Lid (14" FP/28" FLP)	\$876.49	\$697.66
336320	Jotto Patriot	425-6625	NX-5000 KCH-19, NX-5800	\$43.24	\$34.42
336320	Jotto Patriot	425-6629	HD Ram 09+ (28" FLP - Front/Rear Legs)	\$174.13	\$138.60
336320	Jotto Patriot	425-6630	HD Ram 09+ Floor Plate Legs (Front/Rear Legs)	\$119.21	\$94.89
336320	Jotto Patriot	425-6636	Charger 11+ with Dual ABS Cup Holder (14" FP)	\$490.83	\$390.69
336320	Jotto Patriot	425-6639	NX-3720/3820HG	\$43.24	\$34.42
336320	Jotto Patriot	425-6644	Charger 16+ Max Depth IPBCC Console (16" FP)	\$612.15	\$487.25
336320	Jotto Patriot	425-6648	F-250-550 18+ Dash Mount (9" FP), Ford	\$389.55	\$310.07
336320	Jotto Patriot	425-6651	Assembly, 3 12V Outlets in 2" Faceplate (Plastic Cap)	\$57.27	\$45.59
336320	Jotto Patriot	425-6652	Assembly, 3 12V Outlets in 3" Faceplate (Plastic Cap)	\$57.27	\$45.59
336320	Jotto Patriot	425-6655	Durango PPV 19+ (12" FP + 3" Traction Control/Coin Tray FP - 7" top / 5" bottom)	\$612.15	\$487.25
336320	Jotto Patriot	425-6658	STL IntelliSiren	\$43.24	\$34.42
336320	Jotto Patriot	425-6659	Silverado "T1" 1500 19+ / Silverado 2500 20+ (28" FLP - Front/Rear Legs)	\$223.21	\$177.67
336320	Jotto Patriot	425-6660	Silverado 1500 19+ / Silverado 2500 20+ Floor Plate Legs (Front/Rear Legs)	\$102.84	\$81.86
336320	Jotto Patriot	425-6662	Silverado SSV 19+ Dash Mount (8" FP)	\$389.55	\$310.07
336320	Jotto Patriot	425-6664	HD Ram DT19+ (28" FLP - Front/Rear Legs) ***Will NOT Fit 2019 DS (SSV)*** - IN HOUSE, Dodge	\$174.13	\$138.60
336320	Jotto Patriot	425-6666	Pathfinder (Remote Head)	\$43.24	\$34.42
336320	Jotto Patriot	425-6668	F-150 18+ (ALL CONFIGURATIONS) 15-17 (OEM CONSOLE)No Holes	\$153.09	\$121.86
336320	Jotto Patriot	425-6669	Malibu Classic 2016No Holes	\$153.09	\$121.86
336320	Jotto Patriot	425-6671	Malibu NextGen 2016+No Holes	\$153.09	\$121.86
336320	Jotto Patriot	425-6672	Equinox 17+No Holes	\$153.09	\$121.86
336320	Jotto Patriot	425-6674	PI Utility 2020+ (24" FLP - Front/Rear Legs)	\$174.13	\$138.60
336320	Jotto Patriot	425-6675	Defend IR Security Solution FP (GJ/Havis - 2") - IN HOUSE	\$295.00	\$234.81
336320	Jotto Patriot	425-6692	Caprice 11-13 Cupholder w/12V outlets (2 ea) - (Mounts to 425-6691 Console)	\$92.33	\$73.49
336320	Jotto Patriot	425-6693	Caprice 11-13 9C1 MDC (12" FP with mounting brackets)	\$853.11	\$679.05
336320	Jotto Patriot	425-8001	Cargo Barrier Equipment Tray, PI Utility 20+FORD	\$294.00	\$248.83



336320	Jotto Patriot	425-8103	Trunk Tray Charger 11+DODGE	\$515.37	\$436.18
336320	Jotto Patriot	425-8105	Trunk Tray PI Sedan 13+FORD	\$515.37	\$436.18
336320	Jotto Patriot	425-8106	Side Mount Trunk Tray Charger 11+DODGE	\$231.86	\$196.23
336320	Jotto Patriot	450-0449	Accessory - A-MOD Screen Holder - ONLY WORKS WITH A-MOD DESKTOP	\$66.61	\$53.02
336320	Jotto Patriot	450-4008	ML900 Mounting Station - StandardMotorola	\$344.76	\$274.42
336320	Jotto Patriot	450-4009	ML910 Mounting Station - StandardMotorola	\$344.76	\$274.42
336320	Jotto Patriot	450-4018	Latitude D510 14" Mounting Station - StandardDell	\$344.76	\$274.42
336320	Jotto Patriot	450-4019	Latitude D510 15" Mounting Station - StandardDell	\$344.76	\$274.42
336320	Jotto Patriot	450-4020	Latitude D620 Mounting Station - StandardDell	\$344.76	\$274.42
336320	Jotto Patriot	450-4021	Latitude D630, ATG Mounting Station - StandardDell	\$344.76	\$274.42
336320	Jotto Patriot	450-4022	Latitude D820, D830 Mounting Station - StandardDell	\$344.76	\$274.42
336320	Jotto Patriot	450-4023	GB II & GB III Mounting Station - StandardGeneral Dynamics/Itronix	\$344.76	\$274.42
336320	Jotto Patriot	450-4035	CF28/29/30 Mounting Station - StandardPanasonic	\$344.76	\$274.42
336320	Jotto Patriot	450-4040	CF50 Mounting Station -- StandardPanasonic	\$344.76	\$274.42
336320	Jotto Patriot	450-4042	CF51 Mounting Station -- StandardPanasonic	\$344.76	\$274.42
336320	Jotto Patriot	450-4044	CF52 Mounting Station - StandardPanasonic	\$344.76	\$274.42
336320	Jotto Patriot	450-4046	CF73 Mounting Station - StandardPanasonic	\$344.76	\$274.42
336320	Jotto Patriot	450-4048	CF74 Mounting Station StandardPanasonic	\$344.76	\$274.42
336320	Jotto Patriot	450-4058	CF27, CF28, CF29, & CF 30 Docking Station LCD Support	\$116.75	\$92.93
336320	Jotto Patriot	450-4059	Mounting Station LCD Support	\$116.75	\$92.93
336320	Jotto Patriot	450-4060	Kodiak 15.3v DC-DC Adapter for Panasonic Toughbooks Compatible with: CF18, CF19, CF74, CF28, CF29, CF30 low (nit) power screen, CF31 low (nit) power screen (Will not work with High Power screens on CF31, CF30's models)	\$191.66	\$152.56
336320	Jotto Patriot	450-4082	Tecra M5 Mounting Station - StandardToshiba	\$344.75	\$274.41
336320	Jotto Patriot	450-4084	Mounting Station Dual LCD Support	\$186.87	\$148.74
336320	Jotto Patriot	450-4086	CF27, CF28, CF29, & CF30 Serial Port Relocation Kit (Dual)	\$97.00	\$77.21
336320	Jotto Patriot	450-4087	CF27, CF28, CF29, & CF30 Serial Port Relocation Adapter	\$77.36	\$61.58
336320	Jotto Patriot	450-4100	XFR E6400/E6410 Mounting StationDell	\$344.76	\$274.42
336320	Jotto Patriot	450-4101	CF31 Intelligent Docking Station - StandardPanasonic	\$945.00	\$752.19
336320	Jotto Patriot	450-4102	CF31 Intelligent Docking Station - w/Wireless Pass-ThroughPanasonic	\$1,102.50	\$877.56
336320	Jotto Patriot	450-4103	CF31 Intelligent Docking Station - w/Dual Wireless Pass-ThroughPanasonic	\$1,128.75	\$898.45
336320	Jotto Patriot	450-4109	CF53 Mounting Station - StandardPanasonic	\$344.76	\$274.42
336320	Jotto Patriot	450-4111	CF53 Intelligent Docking StationPanasonic	\$945.00	\$752.19
336320	Jotto Patriot	450-4119	Universal Tablet Mounting StationUNIVERSAL	\$280.48	\$223.25
336320	Jotto Patriot	450-4120	USB Strain Relief	\$29.22	\$23.26
336320	Jotto Patriot	450-4125	ATG E6410/E6420 Mounting StationDell	\$344.76	\$274.42
336320	Jotto Patriot	450-4128	Surface Pro Mounting StationMicrosoft	\$280.48	\$223.25
336320	Jotto Patriot	450-4130	Pentax/Brother Printer Mount	\$134.40	\$106.98
336320	Jotto Patriot	450-4131	iPad, iPad 2, iPad 3 & iPad Air Mounting StationApple	\$280.48	\$223.25
336320	Jotto Patriot	450-4134	ATG E6430 Mounting Station (Standard Battery)Dell	\$344.76	\$274.42
336320	Jotto Patriot	450-4136	Toughpad FZ-G1 Mounting StationPanasonic	\$280.48	\$223.25
336320	Jotto Patriot	450-4138	A-MOD Desktop (Tall Clamps) - IN HOUSE	\$309.70	\$246.51
336320	Jotto Patriot	450-4139	A-MOD Desktop XL (Short Clamps) - IN HOUSE	\$309.70	\$246.51
336320	Jotto Patriot	450-4143	A-MOD Desktop w/GK Plate (Tall Clamps)	\$350.60	\$279.07
336320	Jotto Patriot	450-4144	A-MOD Desktop XL w/GK Plate (Short Clamps)	\$350.60	\$279.07
336320	Jotto Patriot	450-4145	Elite X2 Mounting StationHewlett-Packard	\$280.48	\$223.25
336320	Jotto Patriot	450-4147	A-MOD CF33 Desktop w/GK Plate (Short Clamps)	\$350.60	\$279.07
336320	Jotto Patriot	450-4149	Toughpad FZ-G1 w/iKey Keyboard Mounting StationPanasonic	\$350.60	\$279.07
336320	Jotto Patriot	450-4152	A-MOD CF33 Desktop (Short Clamps) - IN HOUSE	\$309.70	\$246.51
336320	Jotto Patriot	450-4153	A-MOD XL Desktop w/GK Plate (Tall Clamps)	\$350.60	\$279.07
336320	Jotto Patriot	450-4154	A-MOD XL Desktop (Tall Clamps) - IN HOUSE	\$309.70	\$246.51
336320	Jotto Patriot	475-0001	Gun RackGR2-AR BLM Horizontal Mount to Partition Window	\$380.40	\$321.95
336320	Jotto Patriot	475-0016	Gun RackGR1-870-Horizontal Mount to Partition Window	\$322.73	\$273.14
336320	Jotto Patriot	475-0023	GR4-AR-UTM - Universal Trunk Mount - Adjustable	\$380.40	\$321.95
336320	Jotto Patriot	475-0054	GR2-AR-Handcuff Lock - Horizontal Mount to Partition Window	\$451.56	\$382.18
336320	Jotto Patriot	475-0058	Impala 06+Window Armor for use with ABS/OEM Door Panels	\$232.56	\$196.83
336320	Jotto Patriot	475-0063	PI Utility 2020+Space Creator - High Security/High Visibility Window (Includes Center HSEP ONLY)	\$1,051.79	\$890.18
336320	Jotto Patriot	475-0065	PI Utility 2020+Space Creator - Full Window w/Safety Wire (Includes Center HSEP ONLY)	\$1,110.22	\$939.63
336320	Jotto Patriot	475-0067	PI Utility 2020+Prisoner Cargo Barrier (CB4)	\$654.44	\$553.88
336320	Jotto Patriot	475-0068	Setina Partition Gun Rack Kit	\$65.04	\$55.05
336320	Jotto Patriot	475-0076	Impala 06+Bio Seat	\$514.21	\$435.20

336320	Jotto Patriot	475-0104	Gun RackGR2-AR-BLM Vertical Mount to Flat Partition Only	\$380.40	\$321.95
336320	Jotto Patriot	475-0157	Prisoner Cargo Barrier (CB1) - Expedition 06+	\$503.69	\$426.30
336320	Jotto Patriot	475-0184	Single Cell Package - Charger 11+	\$1,986.71	\$1,681.45
336320	Jotto Patriot	475-0185	Impala 06+Window Armor and ABS Door Panels	\$292.16	\$247.27
336320	Jotto Patriot	475-0191	Gun RackGR9-AR-BLM Vertical Mount to Flat/Recessed Partition	\$419.66	\$355.18
336320	Jotto Patriot	475-0192	Gun RackGR9-870 Vertical Mount to Flat/Recessed Housing	\$380.40	\$321.95
336320	Jotto Patriot	475-0201	GR4-870-UTM - Universal Trunk Mount Adjustable	\$380.40	\$321.95
336320	Jotto Patriot	475-0214	Impala 06+ABS Door Panels	\$134.40	\$113.75
336320	Jotto Patriot	475-0217	Gun RackGR2-AR-BLM-H Grip Out Horizontal Mount to Partition Window	\$380.40	\$321.95
336320	Jotto Patriot	475-0226	Gun RackGR5/9-870-AR-BLM Vertical Mount to Recessed Housing	\$489.60	\$414.37
336320	Jotto Patriot	475-0228	Window Armor (Bar Style) for use with OEM/ABS Door Panels - Charger 11+	\$244.25	\$206.72
336320	Jotto Patriot	475-0229	Window Armor (Bar Style) and ABS Door Panels - Charger 11+	\$488.49	\$413.43
336320	Jotto Patriot	475-0231	ABS Door Panels - Charger 11+	\$244.25	\$206.72
336320	Jotto Patriot	475-0232	Bio Seat/Floor Pan - Charger 11+	\$656.79	\$555.87
336320	Jotto Patriot	475-0254	Caprice 11+Window Armor (Bar Style) for use with OEM/ABS Door Panels	\$244.25	\$206.72
336320	Jotto Patriot	475-0255	Caprice 11+ABS Door Panels	\$184.64	\$156.27
336320	Jotto Patriot	475-0256	Caprice 11+Window Armor (Bar Style) and ABS Door Panels	\$428.89	\$362.99
336320	Jotto Patriot	475-0267	Floor Pan - Charger 11+	\$209.19	\$177.05
336320	Jotto Patriot	475-0298	Push Bumper - PI Sedan 13+	\$344.76	\$291.79
336320	Jotto Patriot	475-0299	PI Utility 13-19GR6-PI UTILITY-870-AR-BLM	\$580.77	\$491.53
336320	Jotto Patriot	475-0300	Window Armor (Bar Style) and ABS Door Panels - PI Utility 13+	\$583.16	\$493.56
336320	Jotto Patriot	475-0303	Space Creator - Full Window w/Safety Wire (includes Center HSEP ONLY) - PI Utility 13+	\$1,051.79	\$890.18
336320	Jotto Patriot	475-0304	Space Creator - High Security/High Visibility Window (Includes Center HSEP ONLY) - PI Utility 13+	\$1,051.79	\$890.18
336320	Jotto Patriot	475-0308	ABS Door Panels - PI Sedan 13+	\$257.10	\$217.60
336320	Jotto Patriot	475-0309	Window Armor (Bar Style) for use with OEM/ABS Door Panels - PI Utility 13+	\$399.68	\$338.27
336320	Jotto Patriot	475-0310	ABS Door Panels - PI Utility 13+	\$184.64	\$156.27
336320	Jotto Patriot	475-0316	Window Armor (Secure-Grid) for use with OEM/ABS Door Panels - PI Utility 13+	\$327.22	\$276.94
336320	Jotto Patriot	475-0317	Window Armor (Secure-Grid) and ABS Door Panels - PI Utility 13+	\$511.86	\$433.21
336320	Jotto Patriot	475-0322	Bio Seat w/Seat Belt Extenders - Charger 11+	\$680.16	\$575.65
336320	Jotto Patriot	475-0323	Bio Seat/Floor Pan/Seat Belt Extenders - Charger 11+	\$888.17	\$751.70
336320	Jotto Patriot	475-0324	Impala 06+Bio Seat w/Seat Belt Extenders	\$747.94	\$633.02
336320	Jotto Patriot	475-0326	Caprice 11-13Bio Seat w/Seat Belt Extenders	\$680.16	\$575.65
336320	Jotto Patriot	475-0327	Caprice 11-13Bio Seat/Floor Pan/Seat Belt Extenders	\$888.17	\$751.70
336320	Jotto Patriot	475-0328	Extended Seat Belt Kit - Charger 11+	\$292.16	\$247.27
336320	Jotto Patriot	475-0329	Caprice 11-13Extended Seat Belt Kit	\$292.16	\$247.27
336320	Jotto Patriot	475-0368	GR7-AR BLM - Vertical Single Cell Mounted	\$342.36	\$289.76
336320	Jotto Patriot	475-0369	GR7-870 - Vertical Single Cell Mounted	\$284.69	\$240.95
336320	Jotto Patriot	475-0370	GR7-870-AR BLM - Vertical Single Cell Mounted	\$413.52	\$349.98
336320	Jotto Patriot	475-0380	GR7-AR BLM-SUV - Vertical Single Cell Mounted	\$342.36	\$289.76
336320	Jotto Patriot	475-0381	GR7-870 -SUV Vertical Single Cell Mounted	\$284.69	\$240.95
336320	Jotto Patriot	475-0382	GR7-870-AR BLM-SUV - Vertical Single Cell Mounted	\$413.52	\$349.98
336320	Jotto Patriot	475-0393	Caprice 11+Window Armor (Secure-Grid) for use with OEM/ABS Door Panels	\$327.22	\$276.94
336320	Jotto Patriot	475-0394	Caprice 11+Window Armor (Secure-Grid) and ABS Door Panels	\$511.86	\$433.21
336320	Jotto Patriot	475-0411	Charger 11+Partition Transfer Kit - VPTK (only transfers existing VP9 to Charger)	\$276.97	\$234.41
336320	Jotto Patriot	475-0412	Charger 11+HSEP - 2P (VP9 Space Creator)	\$87.65	\$74.18
336320	Jotto Patriot	475-0413	Impala 06+Extended Seat Belt Kit	\$292.16	\$247.27
336320	Jotto Patriot	475-0418	AccessoryZRT Timer	\$53.42	\$45.21
336320	Jotto Patriot	475-0420	Window Armor (Secure-Grid) and ABS Door Panels - Charger 11+	\$477.98	\$404.54
336320	Jotto Patriot	475-0421	Window Armor (Secure-Grid) for use with OEM/ABS Door Panels - Charger 11+	\$233.73	\$197.82
336320	Jotto Patriot	475-0422	Tahoe 11-14HSEP - 2P (VP9 BDRH Only)	\$151.92	\$128.58
336320	Jotto Patriot	475-0423	Tahoe 11-14HSEP - 1P (VP9 Flat Only)	\$151.92	\$128.58
336320	Jotto Patriot	475-0424	ABS Seat Cover - PI Utility 13+	\$502.52	\$425.31
336320	Jotto Patriot	475-0466	Bio Seat/Floor Pan/Seat Belt Extenders -Caprice 14+	\$888.17	\$751.70
336320	Jotto Patriot	475-0468	AccessoryGun Mount Poly Butt Plate	\$40.07	\$33.91

336320	Jotto Patriot	475-0469	Bio Seat w/Seat Belt Extenders - Caprice 14+	\$680.16	\$575.65
336320	Jotto Patriot	475-0471	Floor Pan - Caprice 14+	\$209.19	\$177.05
336320	Jotto Patriot	475-0483	Caprice 11-13Bio Seat	\$448.76	\$379.81
336320	Jotto Patriot	475-0484	Caprice 11-13Floor Pan	\$209.19	\$177.05
336320	Jotto Patriot	475-0485	Caprice 11-13Bio Seat/Floor Pan	\$656.79	\$555.87
336320	Jotto Patriot	475-0534	GR6-TAHOE-870-AR-BLM Dual Gun Rack	\$580.77	\$491.53
336320	Jotto Patriot	475-0537	Impala 06+GR6-IMPALA-870-AR-BLM Dual Gun Rack	\$509.24	\$430.99
336320	Jotto Patriot	475-0538	SUVGR6-SUV-870-AR-BLM Dual Gun Rack	\$580.77	\$491.53
336320	Jotto Patriot	475-0566	Explorer 2011Window Armor for use with ABS Door Panels	\$399.68	\$338.27
336320	Jotto Patriot	475-0567	Explorer 2011ABS Door Panels	\$184.64	\$156.27
336320	Jotto Patriot	475-0568	Explorer 2011Window Armor and ABS Door Panels	\$583.16	\$493.56
336320	Jotto Patriot	475-0580	GR4-870-LG Lock-UTM-Universal Trunk Mount - Adjustable	\$419.66	\$355.18
336320	Jotto Patriot	475-0584	Gun RackGR9- Benelli Nova-AR-BLM Vertical to Flat/Recessed Housing	\$489.60	\$414.37
336320	Jotto Patriot	475-0585	Gun RackGR9-Remington 11-87-AR-BLM Vertical to Flat/Recessed Housing	\$489.60	\$414.37
336320	Jotto Patriot	475-0624	Caprice 11-13GR6-CAPRICE-870-AR-BLM Dual Gun Rack	\$580.77	\$491.53
336320	Jotto Patriot	475-0653	Gun RackGR6-ZRT-PI UTILITY-AR-BLM-870	\$723.45	\$612.29
336320	Jotto Patriot	475-0701	Gun RackGR9-870 - Center Mounted Vertical Mount - to Flat/Recessed Housing	\$419.66	\$355.18
336320	Jotto Patriot	475-0743	Expedition 11-17Window Armor for use with ABS Panels	\$399.68	\$338.27
336320	Jotto Patriot	475-0745	Expedition 11-17Window Armor and ABS Door Panels	\$555.11	\$469.82
336320	Jotto Patriot	475-0746	Expedition 11-17ABS Door Panels	\$175.30	\$148.36
336320	Jotto Patriot	475-0748	PI Utility 2020+GR6-PI UTILITY-870-AR-BLM	\$674.90	\$571.20
336320	Jotto Patriot	475-0749	Bio Seat - Charger 11+	\$448.76	\$379.81
336320	Jotto Patriot	475-0758	Caprice 14+GR6-CAPRICE-870-AR-BLM Dual Gun Rack	\$674.90	\$571.20
336320	Jotto Patriot	475-0767	PI Utility 2020+Single Cell Package	\$2,512.60	\$2,126.53
336320	Jotto Patriot	475-0780	GR4-870-PI SEDAN-Trunk Mount - PI Sedan 13+	\$429.48	\$363.49
336320	Jotto Patriot	475-0781	GR4-AR-BLM-PI SEDAN-Trunk Mount - PI Sedan 13+	\$429.48	\$363.49
336320	Jotto Patriot	475-0789	PI Utility 13-19HSEP - 2P (VP9 Space Creator)	\$151.92	\$128.58
336320	Jotto Patriot	475-0791	PI Utility 2020+Single Cell Lite Package	\$1,470.00	\$1,244.13
336320	Jotto Patriot	475-0802	Charger 11+Space Creator - High Security/High Visibility (includes Center HSEP ONLY)	\$934.92	\$791.27
336320	Jotto Patriot	475-0803	Space Creator - Full Window w/Safety Wire (includes Center HSEP ONLY) - Charger 11+	\$993.35	\$840.72
336320	Jotto Patriot	475-0817	Charger 11+Prisoner Package - VP9 SC - Full Window w/Safety Wire	\$2,220.44	\$1,879.26
336320	Jotto Patriot	475-0818	Charger 11+Prisoner Package - VP9 SC - High Security High Visibility	\$2,220.44	\$1,879.26
336320	Jotto Patriot	475-0821	PI Utility 13-15Rear Cargo Area Window Armor Pkg (Secure-Grid) - left/right/rear	\$701.19	\$593.45
336320	Jotto Patriot	475-0822	Durango 19+Prisoner Cargo Barrier (CB4)	\$654.44	\$553.88
336320	Jotto Patriot	475-0839	PI Utility 2020+UDRH - High Security/High Visibility (Includes Center HSEP ONLY)	\$1,051.79	\$890.18
336320	Jotto Patriot	475-0840	PI Utility 2020+UDRH - Full Window w/Safety Wire (includes Center HSEP ONLY)	\$1,110.22	\$939.63
336320	Jotto Patriot	475-0846	GR4-870-PI UTILITY-Hatch Mount (Multiple Configuration) - PI Utility 13+	\$429.48	\$363.49
336320	Jotto Patriot	475-0847	GR4-AR-BLM-PI UTILITY-Hatch Mount (Multiple Configuration) - PI Utility 13+	\$429.48	\$363.49
336320	Jotto Patriot	475-0848	PI Utility 2020+Window Armor (Bar Style) for use with OEM Door Panels	\$399.68	\$338.27
336320	Jotto Patriot	475-0849	GR3-AR-870-XTRD-GL3XL (2 GL3XL Locks) Vertical Mount to Flat/Recessed Housing	\$736.25	\$623.12
336320	Jotto Patriot	475-0850	GR3-AR-XTRD-GL3XL - Vertical Mount - to Flat/Recessed Housing	\$582.87	\$493.31
336320	Jotto Patriot	475-0851	GR3-870-XTRD-GL3XL - Vertical Mount - to Flat/Recessed Housing	\$543.60	\$460.07
336320	Jotto Patriot	475-0861	Window Armor (Bar Style) for use with OEM/ABS Door Panels - Tahoe 15+	\$350.60	\$296.73
336320	Jotto Patriot	475-0862	Window Armor (Secure-Grid) for use with OEM/ABS Door Panels - Tahoe 15+	\$327.22	\$276.94
336320	Jotto Patriot	475-0864	Single Cell Package - Tahoe 15+	\$2,512.60	\$2,126.53
336320	Jotto Patriot	475-0865	Space Creator - High Security/High Visibility (includes Center HSEP ONLY) - Tahoe 15+	\$1,051.79	\$890.18
336320	Jotto Patriot	475-0866	Space Creator - Full Window w/Safety Wire (includes Center HSEP ONLY) - Tahoe 15+	\$1,110.22	\$939.63
336320	Jotto Patriot	475-0874	Push Bumper - Tahoe 15+	\$618.22	\$523.23
336320	Jotto Patriot	475-0878	Tahoe 15+Partition Transfer Kit - VPTK (only transfers existing VP9 to Tahoe)	\$362.28	\$306.61

336320	Jotto Patriot	475-0888	Tahoe 15+HSEP - 2P (VP9 Space Creator)	\$151.92	\$128.58
336320	Jotto Patriot	475-0893	ABS Door Panels - Tahoe 15+	\$233.73	\$197.82
336320	Jotto Patriot	475-0898	Tahoe 15+GR6-TAHOE-870-AR-BLM Dual Gun Rack	\$580.77	\$491.53
336320	Jotto Patriot	475-0899	GR4-870-TAHOE-Hatch Mount (Multiple Configuration) - Tahoe 15+	\$490.83	\$415.41
336320	Jotto Patriot	475-0900	Rear Cargo Area Window Armor Pkg (Secure-Grid) - left/right/rear - Tahoe 15+	\$219.00	\$185.35
336320	Jotto Patriot	475-0902	PI Utility 2020+Window Armor (Secure-Grid) for use with OEM Door Panels	\$393.75	\$333.25
336320	Jotto Patriot	475-0903	GR4-AR-BLM-TAHOE-Hatch Mount (Multiple Configuration) - Tahoe 15+	\$490.83	\$415.41
336320	Jotto Patriot	475-0923	PI Utility 2020+Replacement Bio-Seat System	\$1,417.50	\$1,199.70
336320	Jotto Patriot	475-0936	Space Creator - High Security/High Visibility (includes Center HSEP ONLY) - Ram 14+	\$1,051.79	\$890.18
336320	Jotto Patriot	475-0937	Space Creator - Full Window w/Safety Wire (includes Center HSEP ONLY) - Ram 14+	\$1,110.22	\$939.63
336320	Jotto Patriot	475-0957	Ram SSV 14+HSEP - 2P (VP9 Space Creator)	\$151.92	\$128.58
336320	Jotto Patriot	475-0961	Window Armor (Bar Style) and ABS Door Panels - Tahoe 15+	\$583.16	\$493.56
336320	Jotto Patriot	475-0962	Window Armor (Secure-Grid) and ABS Door Panels - Tahoe 15+	\$511.86	\$433.21
336320	Jotto Patriot	475-0964	GR4-DCR-GL3 XL-Trunk Mount - Charger 11+	\$460.16	\$389.46
336320	Jotto Patriot	475-0965	Space Creator - High Security/High Visibility (includes Center HSEP ONLY) - Durango 14+	\$1,051.79	\$890.18
336320	Jotto Patriot	475-0966	Space Creator - Full Window w/Safety Wire (includes Center HSEP ONLY) - Durango 14+	\$1,110.22	\$939.63
336320	Jotto Patriot	475-0968	PI Utility 2020+HSEP - 2P (VP9 Space Creator)	\$151.92	\$128.58
336320	Jotto Patriot	475-0973	Replacement Bio Seat System - Tahoe 15+	\$1,379.01	\$1,167.12
336320	Jotto Patriot	475-0974	Replacement Bio Seat System - PI Utility 15+	\$1,379.01	\$1,167.12
336320	Jotto Patriot	475-0983	Single Cell Lite Package - Charger 15+	\$934.92	\$791.27
336320	Jotto Patriot	475-0985	Single Cell Lite Package - Tahoe 15+	\$1,402.38	\$1,186.90
336320	Jotto Patriot	475-0986	Single Cell Lite Package - Charger 15+	\$934.92	\$791.27
336320	Jotto Patriot	475-1004	Push Bumper - Charger 15+	\$344.76	\$291.79
336320	Jotto Patriot	475-1007	PI Utility 2020+HSEP - 2P (VP9 UDRH)	\$151.92	\$128.58
336320	Jotto Patriot	475-1040	Vehicle Partition, 13+ PI Utility UDRH Partition - Full/SW Window	\$1,051.79	\$890.18
336320	Jotto Patriot	475-1041	PI Utility 13-19HSEP - 2P (VP9 UDRH)	\$151.92	\$128.58
336320	Jotto Patriot	475-1042	Charger 11+GR6-DCR-870-AR-BLM Dual Gun Rack	\$580.77	\$491.53
336320	Jotto Patriot	475-1057	Space Creator - High Security/High Visibility Window (Includes Center HSEP ONLY) - F-150 SSV 15+	\$1,051.79	\$890.18
336320	Jotto Patriot	475-1066	Gun RackGR3-870-AR-GL3XL (1 GL3XL Lock) Vertical Mount to Flat/Recessed Housing	\$622.14	\$526.55
336320	Jotto Patriot	475-1092	F-150 SSV 15+Partition Transfer Kit - VPTK	\$362.28	\$306.61
336320	Jotto Patriot	475-1104	Space Creator - Full Window w/Safety Wire (includes Center HSEP ONLY) - F-150 SSV 15+	\$1,110.22	\$939.63
336320	Jotto Patriot	475-1107	F-150 SSV 15+HSEP - 2P (VP9 Space Creator)	\$151.92	\$128.58
336320	Jotto Patriot	475-1109	Prisoner Cargo Barrier (CB4) - PI Utility 16+	\$654.44	\$553.88
336320	Jotto Patriot	475-1110	Prisoner Cargo Barrier (CB4) - Upper Poly - IN HOUSE - PI Utility 16+	\$654.44	\$553.88
336320	Jotto Patriot	475-1111	Single Cell Package - PI Utility 16+	\$2,512.60	\$2,126.53
336320	Jotto Patriot	475-1112	Single Cell Lite Package - PI Utility 16+	\$1,402.38	\$1,186.90
336320	Jotto Patriot	475-1113	PI Utility 2020+Rear Cargo Area Window Armor Pkg (Secure-Grid) - left/right/rear	\$701.19	\$593.45
336320	Jotto Patriot	475-1130	Car/SUVGR7-AR Sideways - Vertical Single Cell Mounted	\$342.36	\$289.76
336320	Jotto Patriot	475-1146	Vehicle Partition, 13+ PI Utility UDRH Partition - HS/HV Window	\$1,051.79	\$890.18
336320	Jotto Patriot	475-1151	Silverado SSV 16-18Window Armor (Bar Style) for use with OEM Door Panels	\$409.03	\$346.18
336320	Jotto Patriot	475-1156	Silverado SSV 16-18Rear Window Armor	\$409.03	\$346.18
336320	Jotto Patriot	475-1167	F150 16+Window Armor (Bar Style) for use with OEM Door Panels	\$409.03	\$346.18
336320	Jotto Patriot	475-1168	F150 16+Rear Window Armor	\$409.03	\$346.18
336320	Jotto Patriot	475-1169	Silverado SSV 16-18Door & Rear Window Armor Package	\$701.19	\$593.45
336320	Jotto Patriot	475-1170	Ram SSV 15+Door & Rear Window Armor Package	\$701.19	\$593.45
336320	Jotto Patriot	475-1173	Durango 19+Prisoner Cargo Barrier (CB4) with Upper Poly Cover	\$714.00	\$604.29
336320	Jotto Patriot	475-1179	Silverado 16-18Single Cell Lite Package (SSV)	\$1,335.60	\$1,130.38
336320	Jotto Patriot	475-1182	PI Utility 16-19Prisoner Cargo Barrier for Storage System (CB6)	\$445.20	\$376.79
336320	Jotto Patriot	475-1183	PI Utility 16-19Single Cell Package for Storage System	\$2,170.35	\$1,836.87
336320	Jotto Patriot	475-1185	Storage/Tub Organizer with Lid - 3 Sections - Adjustable	\$222.60	\$177.18
336320	Jotto Patriot	475-1186	GR6-SILVERADO-870-AR-BLM Dual Gun Rack	\$674.90	\$571.20

336320	Jotto Patriot	475-1191	GR6-F150-870-AR-BLM Dual Gun Rack	\$674.90	\$571.20
336320	Jotto Patriot	475-1193	GR6-Ram-870-AR-BLM Dual Gun Rack	\$674.90	\$571.20
336320	Jotto Patriot	475-1208	PI Utility 2020+UDRH Transfer Kit - VPTK (only transfers VP9 UDRH to PI Utility)	\$299.25	\$253.27
336320	Jotto Patriot	475-1209	Single Cell Lite Package for Storage System	\$1,224.30	\$1,036.18
336320	Jotto Patriot	475-1221	LockZRT Lock Head with AR Insert (HCK)	\$222.60	\$188.40
336320	Jotto Patriot	475-1222	LockZRT Lock Head with AR Insert (STR)	\$222.60	\$188.40
336320	Jotto Patriot	475-1247	Tahoe 15+Prisoner Cargo Barrier for Storage System (CB6)	\$695.63	\$588.74
336320	Jotto Patriot	475-1250	Tahoe 15+Single Cell Package for Storage System	\$2,392.95	\$2,025.27
336320	Jotto Patriot	475-1251	PI Utility 2020+OEM Door Control Covers	\$52.50	\$44.43
336320	Jotto Patriot	475-1266	Tahoe 15+Single Cell Lite Package for Storage System	\$1,669.50	\$1,412.98
336320	Jotto Patriot	475-1267	Ram SSV 14+Single Cell Lite Package	\$1,558.20	\$1,318.78
336320	Jotto Patriot	475-1291	F-150 18+Single Cell Lite Package (SSV/Police Responder)	\$1,558.20	\$1,318.78
336320	Jotto Patriot	475-1301	PI Utility 16-19Prisoner Cargo Barrier (CB4-EZ)	\$654.44	\$553.88
336320	Jotto Patriot	475-1325	Tahoe 15+Prisoner Cargo Barrier (CB4)	\$654.44	\$553.88
336320	Jotto Patriot	475-1337	PI Utility 2020+Prisoner Cargo Barrier (CB4) with Upper Poly Cover	\$714.00	\$604.29
336320	Jotto Patriot	475-1355	Silverado SSV 19+Space Creator - High Security/High Visibility (includes Center HSEP ONLY)	\$1,051.79	\$890.18
336320	Jotto Patriot	475-1368	Silverado 19+Partition Transfer Kit - VPTK	\$362.28	\$306.61
336320	Jotto Patriot	475-1371	Silverado SSV 19+HSEP - 2P	\$151.92	\$128.58
336320	Jotto Patriot	475-1372	Silverado SSV 19+Window Armor (Bar Style) for use with OEM Door Panels	\$409.03	\$346.18
336320	Jotto Patriot	475-1376	Silverado SSV 19+Space Creator - Full Window w/Safety Wire (includes Center HSEP ONLY)	\$1,110.22	\$939.63
336320	Jotto Patriot	475-1380	Silverado 19+Single Cell Lite Package (SSV)	\$1,558.20	\$1,318.78
336320	Jotto Patriot	475-1401	PI Utility 2020+Window Armor (Bar Style) and Door Control Covers	\$441.00	\$373.24
336320	Jotto Patriot	475-1404	Silverado SSV 19+Door & Rear Window Armor Package	\$701.19	\$593.45
336320	Jotto Patriot	475-1407	Silverado SSV 19+Rear Window Armor	\$409.03	\$346.18
336320	Jotto Patriot	475-1417	Durango PPV 19+Window Armor (Bar Style) for use with OEM Door Panels	\$409.03	\$346.18
336320	Jotto Patriot	475-1475	PI Utility 2020+Space Creator Transfer Kit - VPTK (only transfers VP9 SC to PI Utility)	\$299.25	\$253.27
336320	Jotto Patriot	475-1486	PI Utility 2020+Window Armor (Secure-Grid) and Door Control Covers	\$435.75	\$368.80
336320	Jotto Patriot	475-1516	Durango PPV 18+Replacement Bio Seat System	\$1,417.50	\$1,199.70
336320	Jotto Patriot	475-1528	PI Utility 2020+GR4-ZRT-AR BLM-PI Utility 20+ Hatch Mount	\$528.68	\$447.45
336320	Jotto Patriot	475-1529	PI Utility 2020+GR4-ZRT-870-PI Utility 20+ Hatch Mount	\$528.68	\$447.45
336320	Jotto Patriot	475-1530	PI Utility 2020+GR4-AR BLM-PI Utility 20+ Hatch Mount	\$490.83	\$415.41
336320	Jotto Patriot	475-1531	PI Utility 2020+GR4-870-PI Utility 20+ Hatch Mount	\$490.83	\$415.41
336320	Jotto Patriot	475-1545	Durango SSV 18+UDRH Transfer Kit - VPTK (only transfers VP9 UDRH to Durango)	\$362.28	\$306.61
336320	Jotto Patriot	475-1555	Durango 18+UDRH - Full Window w/Safety Wire (includes Center HSEP ONLY)	\$1,110.22	\$939.63
336320	Jotto Patriot	475-1556	Durango 18+UDRH - High Security/High Visibility (includes Center HSEP ONLY)	\$1,051.79	\$890.18
336320	Jotto Patriot	475-1557	Durango 18+HSEP - 2P (VP9 UDRH)	\$116.87	\$98.91
336320	Jotto Patriot	475-1935	Ram SSV 14+Partition Transfer Kit - VPTK (only transfers existing VP9 to Ram)	\$362.28	\$306.61
336320	Jotto Patriot	475-1936	Durango SSV 14+Partition Transfer Kit - VPTK (only transfers existing VP9 to Durango)	\$362.28	\$306.61
336320	Jotto Patriot	475-2001	Gun RackGR3-AR BLM-870-XTRD VP3/8/9	\$451.56	\$382.18
336320	Jotto Patriot	475-2010	Gun RackGR9-ZRT-AR-BLM-870 - Vertical Mount to Flat/Recessed Housing	\$612.15	\$518.09
336320	Jotto Patriot	475-2011	Gun RackGR2-ZRT-AR-BLM-GRIP OUT - Horizontal Mount to Partition Window	\$445.20	\$376.79
336320	Jotto Patriot	475-2012	Gun RackGR1-ZRT-870 - Horizontal Mount to Partition Window	\$389.55	\$329.69
336320	Jotto Patriot	475-2013	Gun RackGR2-ZRT-AR-BLM-GRIP DOWN - Horizontal Mount to Partition Window	\$445.20	\$376.79
336320	Jotto Patriot	475-2014	Gun RackGR9-ZRT-870 - Vertical Mount - to Flat/Recessed Housing	\$445.20	\$376.79
336320	Jotto Patriot	475-2015	Gun RackGR9-ZRT-AR-BLM - Vertical Mount - to Flat/Recessed Housing	\$473.03	\$400.35
336320	Jotto Patriot	475-2016	GR6-ZRT-DCR-AR-BLM-870 - Dual Gun Rack	\$678.93	\$574.61
336320	Jotto Patriot	475-2018	GR6-ZRT-PI UTILITY-AR-BLM-870	\$667.80	\$565.19
336320	Jotto Patriot	475-2019	Gun RackGR6-ZRT-CAPRICE-AR-BLM-870 - Dual Gun Rack	\$723.45	\$612.29
336320	Jotto Patriot	475-2020	Gun RackGR6-ZRT-CAPRICE-AR-BLM-870 - Dual Gun Rack	\$723.45	\$612.29
336320	Jotto Patriot	475-2021	Gun RackGR6-ZRT-IMPALA-AR-BLM-870 - Dual Gun Rack	\$612.15	\$518.09
336320	Jotto Patriot	475-2022	GR6-ZRT-TAHOE-AR-BLM-870 - Dual Gun Rack	\$667.80	\$565.19

336320	Jotto Patriot	475-2023	GR6-ZRT-TAHOE-AR-BLM-870 - Dual Gun Rack	\$667.80	\$565.19
336320	Jotto Patriot	475-2024	GR6-ZRT-SUV-AR-BLM-870 - Dual Gun Rack	\$667.80	\$565.19
336320	Jotto Patriot	475-2025	GR6-ZRT-SILVERADO-AR-BLM-870 - Dual Gun Rack	\$723.45	\$612.29
336320	Jotto Patriot	475-2026	GR6-ZRT-F150-AR-BLM-870 - Dual Gun Rack	\$723.45	\$612.29
336320	Jotto Patriot	475-2027	GR4-ZRT-870-UTM - Universal Trunk Mount - Adjustable	\$417.38	\$353.25
336320	Jotto Patriot	475-2028	GR4-ZRT-AR-BLM-UTM - Universal Trunk Mount - Adjustable	\$417.38	\$353.25
336320	Jotto Patriot	475-2029	GR4-ZRT-AR-BLM-PI SEDAN - Trunk Mount	\$428.51	\$362.67
336320	Jotto Patriot	475-2030	GR4-ZRT-PI SEDAN-870 - Trunk Mount	\$428.51	\$362.67
336320	Jotto Patriot	475-2031	GR4-ZRT-AR-BLM-PI UTILITY- Hatch Mount	\$428.51	\$362.67
336320	Jotto Patriot	475-2032	GR4-ZRT-PI UTILITY-870 - Hatch Mount	\$428.51	\$362.67
336320	Jotto Patriot	475-2033	GR4-ZRT-AR-BLM-TAHOE - Hatch Mount	\$528.68	\$447.45
336320	Jotto Patriot	475-2034	GR4-ZRT-TAHOE-870 - Hatch Mount	\$528.68	\$447.45
336320	Jotto Patriot	475-2036	GR7-ZRT-870 - Vertical Single Cell Mounted	\$289.38	\$244.92
336320	Jotto Patriot	475-2038	GR7-ZRT-AR-BLM-870 - Vertical Single Cell Mounted	\$511.98	\$433.31
336320	Jotto Patriot	475-2042	GR9-ZRT-AR-BLM - Vertical Mount to Recessed Housing	\$651.11	\$551.07
336320	Jotto Patriot	475-2043	GR9-ZRT-AR-BLM-1187 - Vertical Mount to Recessed Housing	\$651.11	\$551.07
336320	Jotto Patriot	475-2044	GR5/9-ZRT-AR-BLM-870 - Vertical Mount to Recessed Housing	\$651.11	\$551.07
336320	Jotto Patriot	475-2045	GR6-ZRT-Ram-AR-BLM-870 - Dual Gun Rack	\$723.45	\$612.29
336320	Jotto Patriot	475-2046	GR7-ZRT-AR-BLM-Sideways - Vertical Single Cell Mounted	\$333.90	\$282.60
336320	Jotto Patriot	475-2047	GR7-ZRT-AR-BLM-870 - Vertical Single Cell Mounted	\$511.98	\$433.31
336320	Jotto Patriot	475-2048	GR7-ZRT-AR-BLM-Sideways - Vertical Single Cell Mounted	\$333.90	\$282.60
336320	Jotto Patriot	475-2049	GR7-ZRT-TAHOE-AR-BLM-870 - Vertical Single Cell Mounted	\$511.98	\$433.31
336320	Jotto Patriot	475-2050	GR7-ZRT-TAHOE-AR-BLM-Sideways - Vertical Single Cell Mounted	\$333.90	\$282.60
336320	Jotto Patriot	475-2052	Gun RackGR9-ZRT-AR SECURE-BLM-870 - Vertical Mount to Recessed Housing	\$923.79	\$781.85
336320	Jotto Patriot	475-2053	Gun RackGR9-ZRT-AR SECURE-BLM - Vertical Mount to Recessed Housing	\$694.51	\$587.80
336320	Jotto Patriot	475-2054	Gun RackGR9-ZRT-DUAL-AR-BLM - Vertical Mount to Recessed Housing	\$667.80	\$565.19
336320	Jotto Patriot	475-2055	Gun RackGR6-ZRT-SILVERADO-AR-BLM-870 - Dual Gun Rack	\$787.50	\$666.50
336320	Jotto Patriot	475-2056	Gun RackGR6-ZRT-DURANGO-AR-BLM-870 - Dual Gun Rack	\$787.50	\$666.50
336320	Jotto Patriot	475-2057	Silverado SSV 19+GR6-SILVERADO-AR-BLM-870 Dual Gun Rack	\$735.00	\$622.07
336320	Jotto Patriot	475-2058	Durango 19+GR6-DURANGO-AR-BLM-870 Dual Gun Rack	\$735.00	\$622.07
336320	Jotto Patriot	475-2063	Gun RackGR9, ZRT, AR-GL3-XL/870 Featuring SmartLok Technology	\$1,050.00	\$888.66
336320	Jotto Patriot	475-3000	Vehicle Partition, 13+ PI Sedan UDRH Partition - HS/HV Window	\$934.92	\$791.27
336320	Jotto Patriot	475-3001	Vehicle Partition, 11+ Charger UDRH Partition - HS/HV Window	\$934.92	\$791.27
336320	Jotto Patriot	475-3002	Vehicle Partition, 11+ Charger UDRH Partition - Full/SW Window	\$993.35	\$840.72
336320	Jotto Patriot	475-3003	Charger 11+HSEP - 2P (VP9 UDRH)	\$87.65	\$74.18
336320	Jotto Patriot	475-3004	Vehicle Partition, 15+ Tahoe UDRH Partition - HS/HV Window	\$1,051.79	\$890.18
336320	Jotto Patriot	475-3005	Vehicle Partition, 15+ Tahoe UDRH Partition - Full/SW Window	\$1,110.22	\$939.63
336320	Jotto Patriot	475-3006	Tahoe 15+HSEP - 2P (VP9 UDRH)	\$151.92	\$128.58
336320	Jotto Patriot	475-3007	Charger 11+UDRH Transfer Kit - VPTK (only transfers VP9 UDRH to Charger)	\$276.97	\$234.41
336320	Jotto Patriot	475-3010	Tahoe 15+UDRH Transfer Kit - VPTK (only transfers VP9 UDRH to Tahoe)	\$362.28	\$306.61
336320	Jotto Patriot	475-6970	PI Utility 16-19Rear Cargo Area Window Armor Pkg (Secure-Grid) - left/right/rear	\$701.19	\$593.45
336320	Jotto Patriot	475-7101	LockLarge Lock Head - GL2 (HCK)	\$166.89	\$141.25
336320	Jotto Patriot	475-7208	AccessoryMomentary Switch	\$15.95	\$13.50
336320	Jotto Patriot	475-7209	AccessoryGun Lock Timer (GL-T)	\$46.63	\$39.47
336320	Jotto Patriot	475-7462	LockGL3-XL Handcuff Lock (HCK)	\$257.69	\$218.10
336320	Jotto Patriot	475-8151	AccessoryGun Mount ABS Butt Plate	\$39.27	\$33.24
336320	Jotto Patriot	475-8342	PI Utility 13-19Space Creator Transfer Kit - VPTK (only transfers VP9 SC to PI Utility)	\$276.97	\$234.41
336320	Jotto Patriot	475-8410	GR9/VP9 Gun Rack Adaptor Bracket	\$12.88	\$10.90
336320	Jotto Patriot	475-8485	AR-15 Replacement Breakdown Pin	\$24.54	\$20.77
336320	Jotto Patriot	475-8819	LockGL3-XL Handcuff Lock (STR)	\$257.69	\$218.10
336320	Jotto Patriot	475-8848	Durango 14+HSEP - 2P (VP9 Space Creator)	\$116.87	\$98.91
336320	Jotto Patriot	475-8924	LockSmall Lock Head - GL1 (HCK)	\$127.62	\$108.01
336320	Jotto Patriot	475-8925	LockSmall Lock Head - GL1 (STR)	\$127.62	\$108.01
336320	Jotto Patriot	475-8926	LockSmall Lock Head - GL1 (BRL)	\$127.62	\$108.01
336320	Jotto Patriot	475-8927	LockLarge Lock Head - GL2 (STR)	\$166.89	\$141.25
336320	Jotto Patriot	475-8928	LockLarge Lock Head - GL2 (BRL)	\$166.89	\$141.25

336320	Jotto Patriot	475-8969	PI Utility 13-19UDRH Transfer Kit - VPTK (only transfers VP9 UDRH to PI Utility)	\$276.97	\$234.41
336320	Jotto Patriot	475-9181	F150 16+Door & Rear Window Armor Package	\$701.19	\$593.45
336320	Jotto Patriot	475-9196	Ram SSV 15+Rear Window Armor	\$409.03	\$346.18
336320	Jotto Patriot	475-9197	Ram SSV 15+Window Armor (Bar Style) for use with OEM Door Panels	\$409.03	\$346.18
336320	Jotto Patriot	475-9262	LockZRT Lock Head with Shotgun Insert (STR)	\$222.60	\$188.40
336320	Jotto Patriot	475-9263	LockZRT Lock Head with Shotgun Insert (HCK)	\$222.60	\$188.40
336320	Jotto Patriot	GGH	Build with 2 - GL3XL Locks (HCK Key)	\$262.61	\$222.26
336320	Jotto Patriot	GGS	Build with 2 - GL3XL Locks (STR Key)	\$262.61	\$222.26
336320	Jotto Patriot	GLH	Build GR7 Single Gun Rack with GL3XL Lock (HCK Key)	\$131.30	\$111.13
336320	Jotto Patriot	GLS	Build GR7 Single Gun Rack with GL3XL Lock (STR Key)	\$131.30	\$111.13
336320	Jotto Patriot	GSH	Build AR with GL3XL Lock and 870 with GL1 Lock (HCK Key)	\$131.30	\$111.13
336320	Jotto Patriot	GSS	Build AR with GL3XL Lock and 870 with GL1 Lock (STR Key)	\$131.30	\$111.13
336320	Jotto Patriot	SGH	Build AR with BLM GL1 Lock and 870 with GL3XL Lock (HCK Key)	\$131.30	\$111.13
336320	Jotto Patriot	SGS	Build AR with BLM GL1 Lock and 870 with GL3XL Lock (STR Key)	\$131.30	\$111.13
336320	Neology	75-0302-0514-2	P634 810NM 25/12	\$2,500.00	\$2,267.00
336320	Neology	75-0302-1654-5	GPS 16X- MOBILE	\$220.00	\$199.50
336320	Neology	75-0302-1708-9	P634 OUTRIGGER FOR ZCB (1/CAM)	\$75.00	\$68.01
334220	Neology	75-0302-1721-2	AUXILIARY MOUNT (SUPPORTS 1 ADDITIONAL CAM)	\$225.00	\$204.03
336320	Neology	75-0302-1764-2	Mobile ANPR Processor for permanent mount in a vehicle - Supports up to 4 dual lens Slate cameras.	\$7,250.00	\$6,574.31
336320	Neology	75-0302-1774-1	3 CAM LEGEND MOUNTING ASSEMBLY	\$900.00	\$816.12
336320	Neology	75-0302-1775-8	3 CAM WHELEN MOUNTING ASSEMBLY	\$800.00	\$725.44
336320	Neology	75-0302-1776-6	4 CAM LEGEND MOUNTING ASSEMBLY	\$1,000.00	\$906.80
336320	Neology	75-0302-1777-4	4 CAM WHELEN MOUNTING ASSEMBLY	\$900.00	\$816.12
336320	Neology	75-0302-1778-2	2 CAM LEGEND MOUNTING ASSEMBLY	\$800.00	\$725.44
336320	Neology	75-0302-1781-6	2 CAM WHELEN MOUNTING ASSEMBLY	\$700.00	\$634.76
336320	Neology	75-0302-1786-5	3 CAM ARJENT MOUNTING ASSEMBLY	\$900.00	\$816.12
336320	Neology	75-0302-1787-3	4 CAM ARJENT MOUNTING ASSEMBLY	\$1,050.00	\$952.14
336320	Neology	75-0302-1789-9	2 CAM ARJENT MOUNTING ASSEMBLY	\$750.00	\$680.10
336320	Neology	75-0302-1790-7	P634 ZERO CLEARANCE BRKT	\$175.00	\$158.69
336320	Neology	75-0302-1802-0	TRUNK MOUNT	\$475.00	\$430.73
336320	Neology	75-0302-1803-8	MAGNET MOUNT FOR SUV (1/CAM)	\$475.00	\$430.73
336320	Neology	75-0302-1805-3	Gutter Mount Assembly, Explorer	\$550.00	\$498.74
336320	Neology	75-0302-1807-9	2 CAM UNMARKED MOUNTING ASSEMBLY	\$750.00	\$680.10
336320	Neology	75-0302-1808-7	3 CAM UNMARKED MOUNTING ASSEMBLY	\$900.00	\$816.12
336320	Neology	75-0302-1809-5	4 CAM UNMARKED MOUNTING ASSEMBLY	\$1,050.00	\$952.14
336320	Neology	75-0302-1810-3	3 CAM TOMAR MOUNTING ASSEMBLY	\$1,200.00	\$1,088.16
336320	Neology	75-0302-1812-9	2 CAM CODE 3 FOR <13.25" LB ASSEMBLY	\$900.00	\$816.12
336320	Neology	75-0302-1813-7	3 CAM CODE 3 FOR <13.25" LB ASSEMBLY	\$1,100.00	\$997.48
336320	Neology	75-0302-1814-5	4 CAM CODE 3 FOR <13.25" LB ASSEMBLY	\$1,300.00	\$1,178.84
336320	Neology	75-0302-1820-2	2 CAM WHELEN/JUSTICE MOUNTING ASSEMBLY	\$1,550.00	\$1,405.54
336320	Neology	75-0302-1821-0	3 CAM WHELEN/JUSTICE MOUNTING ASSEMBLY	\$1,700.00	\$1,541.56
336320	Neology	75-0302-1822-8	4 CAM WHELEN/JUSTICE MOUNTING ASSEMBLY	\$1,850.00	\$1,677.58
336320	Neology	75-0302-1824-4	3 CAM VALOR MOUNTING ASSEMBLY	\$1,125.00	\$1,020.15
336320	Neology	75-0302-1827-7	2 CAM VALOR MOUNTING ASSEMBLY	\$1,000.00	\$906.80
334220	Neology	75-0302-1828-5	4 CAM VALOR MOUNTING ASSEMBLY	\$1,250.00	\$1,133.50
334220	Neology	75-0302-1924-2	Advance Mapping	\$795.00	\$720.91
334220	Neology	75-0302-1942-4	Annual maintenance for the 3M BOSS back office system software.	\$300.00	\$272.04
336320	Neology	75-0302-2162-8	SDK Software (USB Dongle)	\$2,500.00	\$2,267.00
334220	Neology	75-0302-2230-3	UNIVERSAL FIXED BRKTS (P392+/P492)	\$850.00	\$770.78
334220	Neology	75-0302-3112-2	1 Concurrent User License	\$400.00	\$362.72
334220	Neology	75-0302-3113-0	Basic license w/ two concurrent users	\$995.00	\$902.27
334220	Neology	75-0302-3114-8	5 Users Licenses	\$1,250.00	\$1,133.50
334220	Neology	75-0302-3115-5	Block of 100 Concurrent User Licenses	\$15,000.00	\$13,602.02
336320	Neology	75-0302-3116-3	10 Users Licenses	\$2,250.00	\$2,040.30
334220	Neology	75-0302-3117-1	Block of 25 Concurrent User Licenses	\$5,000.00	\$4,534.01
334220	Neology	75-0302-3118-9	Block of 50 Concurrent User Licenses	\$8,750.00	\$7,934.51
334220	Neology	75-0302-3183-3	PREWIRE KIT FOR 4-CAM MOBILE SYST GPS	\$1,550.00	\$1,405.54
334220	Neology	75-0302-3564-4	SUV REAR FACING LIGHTBAR MOUNT	\$225.00	\$204.03
334220	Neology	75-0302-3682-4	Annual maintenance for 3M FOUR camera mobile and portable vehicle systems including PAGIS in-car display software and OCR updates.	\$1,500.00	\$1,360.20

334220	Neology	75-0302-3683-2	Annual maintenance for 3M THREE camera mobile and portable vehicle systems including PAGIS in-car display software and OCR updates.	\$1,400.00	\$1,269.52
334220	Neology	75-0302-3684-0	Annual maintenance for 3M TWO camera mobile and portable vehicle systems including PAGIS in-car display software and OCR updates.	\$1,300.00	\$1,178.84
334220	Neology	75-0302-3685-7	Annual maintenance for 3M ONE camera mobile and portable vehicle systems including PAGIS in-car display software and OCR updates.	\$1,200.00	\$1,088.16
336320	Neology	75-0302-3741-8	2 CAM TOMAR MOUNTING ASSEMBLY	\$1,075.00	\$974.81
336320	Neology	75-0302-3742-6	4 CAM TOMAR MOUNTING ASSEMBLY	\$1,325.00	\$1,201.51
334220	Neology	75-0302-3785-5	Gutter Mount Assembly, Tahoe	\$550.00	\$498.74
336320	Neology	75-0302-3830-9	LPCS Yearly Maintenance Pkg Billing Only	\$785.00	\$711.84
334220	Neology	75-0302-5460-3	TBOX 1-48V 1 P492 w/o cable for P500 Series Camera	\$1,000.00	\$906.80
334220	Neology	75-0302-5461-1	TBOX 2-48V 2 P492 w/o cable for P500 Series Camera	\$1,450.00	\$1,314.86
336320	Neology	75-0302-5462-9	TBOX 3-48V 3 P492 w/o cable for P500 Series Camera	\$2,000.00	\$1,813.60
334220	Neology	75-0302-5595-6	SX4 ALPR PROCESSOR AND POWER CORD	\$5,800.00	\$5,259.45
334220	Neology	75-0304-5100-1	BOSS 4.0 License - New License	\$1,995.00	\$1,809.07
334220	Neology	75-0304-5110-0	BOSS 4.0 License – Renewal License	\$1,995.00	\$1,809.07
334220	Neology	75-0304-5200-9	Auto Vehicle Identification Software License - New License	\$800.00	\$725.44
334220	Neology	75-0304-5210-8	Auto Vehicle Identification Software License – Renewal License	\$800.00	\$725.44
336320	Neology	78-0060-2909-0	P492/P382 INTERNAL CHASSIS 48V	\$750.00	\$680.10
336320	Neology	78-0060-3821-6	P634 15 FT CAMERA CABLE	\$300.00	\$272.04
336320	Neology	78-0060-3828-1	PIPS Technology™ ALPR PROCESSOR POWER CORD	\$85.00	\$77.08
334220	Neology	78-0060-3831-5	P634 22 FT CAMERA CABLE	\$350.00	\$317.38
334220	Neology	78-8800-0478-9	UL Listed 48V Power Supply Camera Interface Module 48V	\$750.00	\$680.10
334220	Neology	78-8800-2162-7	SX4 Mobile ALPR Processor Only	\$5,800.00	\$5,259.45
334220	Neology	FA3100100000	Aluminum I bracket for pole mounting. Banding straps not included.	\$80.00	\$72.54
334220	Neology	FA432-0000-000	Interface Adapter Box (IAB)	\$381.18	\$345.65
334220	Neology	FA4401400000	Provides Ethernet and RS232 connections to P500 cameras in PIPS Gen-3 Interface Box, CIM to powerblock cable included. Power Supply sold separately	\$660.00	\$598.49
334220	Neology	FC5742050000	P500 2K sensor 740nm Ethernet Only	\$8,050.00	\$7,299.75
334220	Neology	FC5742050001	P500 2K sensor 740nm 4G Modem	\$8,450.00	\$7,662.47
334220	Neology	FC5742050010	P500 2K sensor 740nm Wifi & GPS	\$8,450.00	\$7,662.47
334220	Neology	FC5742050012	P500 2K sensor 740nm, GPS & 4G Modem	\$8,950.00	\$8,115.87
334220	Neology	FC5742550000	P500 2.5K sensor 740nm Ethernet Only	\$9,050.00	\$8,206.55
334220	Neology	FC5742550001	P500 2.5K sensor 740nm 4G Modem	\$9,495.00	\$8,610.08
334220	Neology	FC5742550010	P500 2.5K sensor 740nm Wifi & GPS	\$9,495.00	\$8,610.08
334220	Neology	FC5742550012	P500 2.5K sensor 740nm, GPS & 4G Modem	\$9,995.00	\$9,063.48
334220	Neology	FC5812050000	P500 2K sensor 810nm Ethernet Only	\$8,050.00	\$7,299.75
334220	Neology	FC5812050002	P500 2K sensor 810nm 4G Modem	\$8,450.00	\$7,662.47
334220	Neology	FC5812050010	P500 2K sensor 810nm, GPS & 4G Modem	\$8,950.00	\$8,115.87
334220	Neology	FC5812050012	P500 2K sensor 810nm Wifi & GPS	\$8,450.00	\$7,662.47
334220	Neology	FC5812550000	P500 2.5K sensor 810nm Ethernet Only	\$9,050.00	\$8,206.55
334220	Neology	FC5812550010	P500 2.5K sensor 810nm, GPS & 4G Modem	\$9,995.00	\$9,063.48
334220	Neology	FC5812550012	P500 2.5K sensor 810nm 4G Modem	\$9,495.00	\$8,610.08
334220	Neology	FC5812550110	P500 2.5K sensor 810nm Wifi & GPS	\$9,495.00	\$8,610.08
334220	Neology	FC5852050000	P500 2K sensor 850nm Ethernet Only	\$8,050.00	\$7,299.75
334220	Neology	FC5852050001	P500 2K sensor 850nm 4G Modem	\$8,450.00	\$7,662.47
334220	Neology	FC5852050010	P500 2K sensor 850nm Wifi & GPS	\$8,450.00	\$7,662.47
334220	Neology	FC5852550000	P500 2.5K sensor 850nm Ethernet Only	\$9,050.00	\$8,206.55
334220	Neology	FC5852550001	P500 2.5K sensor 850nm 4G Modem	\$9,495.00	\$8,610.08
334220	Neology	FC5852550010	P500 2.5K sensor 850nm Wifi & GPS	\$9,495.00	\$8,610.08
334220	Neology	FC5852550012	P500 2.5K sensor 850nm, GPS & 4G Modem	\$9,995.00	\$9,063.48
334220	Neology	FC5942050000	P500 2K sensor 940nm Ethernet Only	\$8,050.00	\$7,299.75
334220	Neology	FC5942050001	P500 2K sensor 940nm 4G Modem	\$8,450.00	\$7,662.47
334220	Neology	FC5942050010	P500 2K sensor 940nm Wifi & GPS	\$8,450.00	\$7,662.47
334220	Neology	FC5942050012	P500 2K sensor 940nm, GPS & 4G Modem	\$8,950.00	\$8,115.87
334220	Neology	FC5942550000	P500 2.5K sensor 940nm 4G Modem	\$9,495.00	\$8,610.08
334220	Neology	FC5942550001	P500 2.5K sensor 940nm Ethernet Only	\$9,050.00	\$8,206.55
334220	Neology	FC5942550010	P500 2.5K sensor 940nm Wifi & GPS	\$9,495.00	\$8,610.08
334220	Neology	FC5942550012	P500 2.5K sensor 940nm, GPS & 4G Modem	\$9,995.00	\$9,063.48
334220	Neology	FC8520050012	P500 2K sensor 850nm, GPS & 4G Modem	\$8,950.00	\$8,115.87
334220	Neology	HC350242L002	P500 Single Ethernet - 2.5m	\$193.72	\$175.67
334220	Neology	HC350242L010	P500 Single Ethernet - 10m	\$231.24	\$209.69
334220	Neology	HC350242L015	P500 Single Ethernet - 15m	\$264.51	\$239.86



334220	Neology	HC350242L020	P500 Single Ethernet - 20m	\$311.29	\$282.28
334220	Neology	HC350242L040	P500 Single Ethernet - 40m	\$571.06	\$517.84
334220	Neology	HC350242L050	P500 Single Ethernet - 50m	\$711.32	\$645.03
336320	Neology	HC350244L010	P52X Cables - 10m Ethernet cable & 10m Power and Serial Cable	\$413.70	\$375.14
336320	Neology	HC350244L015	P52X Cables - 15m Ethernet cable & 15m Power and Serial Cable	\$529.01	\$479.71
336320	Neology	HC350244L020	P52X Cables - 20m Ethernet cable & 20m Power and Serial Cable	\$622.57	\$564.55
336320	Neology	HC350244L025	P52X Cables - 25m Ethernet cable & 25m Power and Serial Cable	\$742.80	\$673.57
336320	Neology	HC350244L040	P52X Cables - 40m Ethernet cable & 40m Power and Serial Cable	\$1,142.11	\$1,035.67
336320	Neology	HC350244L050	P52X Cables - 50m Ethernet cable & 50m Power and Serial Cable	\$1,422.63	\$1,290.04
336320	Neology	HW52X0011	Pole Mounting Bracket with pole strap	\$403.00	\$365.44
334220	Neology	LM200-1100-103	2CAM mobile system w/ PIPS hosted Saas BOSS4 w/ Vehicle Classification. Annual cost for 3 year commitment. (hardware installation & mounting brackets not included) BO	\$2,988.00	\$2,709.52
334220	Neology	LM200-1100-105	2CAM mobile system w/ PIPS hosted Saas BOSS4 w/ Vehicle Classification. Annual cost for 5 year commitment. (hardware installation & mounting brackets not included) BO	\$2,496.00	\$2,263.38
334220	Neology	LM201-1100-101	2CAM mobile system maintenance & data hosting in PIPS Saas BOSS4 w/ Vehicle Classification. Annual cost after 5 year commitment. BO	\$1,500.00	\$1,360.20
334220	Neology	LM300-1100-103	3CAM mobile system w/ PIPS hosted Saas BOSS4 w/ Vehicle Classification. Annual cost for 3 year commitment. (hardware installation & mounting brackets not included) BO	\$4,062.00	\$3,683.43
334220	Neology	LM300-1100-105	3CAM mobile system w/ PIPS hosted Saas BOSS4 w/ Vehicle Classification. Annual cost for 5 year commitment. (hardware installation & mounting brackets not included) BO	\$3,493.00	\$3,167.46
334220	Neology	LM301-1100-101	3CAM mobile system maintenance & data hosting in PIPS Saas BOSS4 w/ Vehicle Classification. Annual cost after 5 year commitment. BO	\$2,250.00	\$2,040.30
334220	Neology	LM400-1100-103	4CAM mobile system w/ PIPS hosted Saas BOSS4 w/ Vehicle Classification. Annual cost for 3 year commitment. (hardware installation & mounting brackets not included) BO	\$4,522.00	\$4,100.55
334220	Neology	LM400-1100-105	4CAM mobile system w/ PIPS hosted Saas BOSS4 w/ Vehicle Classification. Annual cost for 5 year commitment. (hardware installation & mounting brackets not included) BO	\$3,997.00	\$3,624.48
334220	Neology	LM401-1100-101	4CAM mobile system maintenance & data hosting in PIPS Saas BOSS4 w/ Vehicle Classification. Annual cost after 5 year commitment. BO	\$2,750.00	\$2,493.70
334220	Neology	LS000-1000-101	PIPS hosted SaaS BOSS4 w/ Vehicle Classification for legacy PIPS cameras. Annual cost. BO	\$1,000.00	\$906.80
336320	Neology	MA1100000005	P720 5 meter (16 ft) Camera Cable	\$300.00	\$272.04
336320	Neology	MA110-0000-005	P720 5meter Camera Cable	\$300.00	\$272.04
336320	Neology	MA1100000007	P720 7 meter (23 ft) Camera Cable	\$350.00	\$317.38
334220	Neology	MA110-0000-007	P720 7meter Camera Cable	\$350.00	\$317.38
334220	Neology	MA1140000001	Lemo Connector - P634 to P720 cable	\$177.16	\$160.65
334220	Neology	MA3720003151	Gutter Mounting Assembly, Tahoe Yr. 2019+	\$550.00	\$498.74
334220	Neology	MA3720003201	Gutter Mounting Assembly, Explorer Yr. 2019+	\$550.00	\$498.74
334220	Neology	MA3720202002	2 Camera APEX Soundoff Nforce Mounting Assembly	\$505.00	\$457.93
334220	Neology	MA3720202003	3 Camera APEX Soundoff Nforce Mounting Assembly	\$758.00	\$687.36
334220	Neology	MA3720202004	4 Camera APEX Soundoff Nforce Mounting Assembly	\$1,010.00	\$915.87
334220	Neology	MC174-1000-000	P720 740nm Parking camera	\$2,800.00	\$2,539.04
334220	Neology	MC174-3000-000	P720 740nm Traffic camera	\$2,800.00	\$2,539.04
334220	Neology	MC1744000000	P720 740nm Long Traffic Camera (25/16)	\$2,800.00	\$2,539.04
334220	Neology	MC181-1000-000	P720 810nm Parking camera	\$2,800.00	\$2,539.04
334220	Neology	MC181-3000-000	P720 810nm Traffic camera	\$2,800.00	\$2,539.04
334220	Neology	MC1814000000	P720 810nm Long Traffic Camera (25/16)	\$2,800.00	\$2,539.04
334220	Neology	MC194-1000-000	P720 940nm Parking camera	\$2,800.00	\$2,539.04
334220	Neology	MC194-3000-000	P720 940nm Traffic camera	\$2,800.00	\$2,539.04
334220	Neology	MC1944000000	P720 940nm Long Traffic Camera (25/16)	\$2,800.00	\$2,539.04
334220	Neology	MP2000000000	SX4 Mobile Processor for P270 cameras, No-WiFi, VP	\$5,800.00	\$5,259.45
334220	Neology	MP2000000010	SX4 Mobile Processor for P270 cameras, No-WiFi, SA	\$5,800.00	\$5,259.45
334220	Neology	MP200-0000-100	SX4e WiFi-VP Mobile ALPR Processor Only	\$5,900.00	\$5,350.13
334220	Neology	MP200-0000-110	SX4e WiFi-SA Mobile ALPR Processor Only	\$5,900.00	\$5,350.13











334220	Neology	MS374-3110-017	PIPS Technology 3 Camera Mobile System, to include 3 P720 Cameras with 740nm illumination, SX4e Mobile Processor, Camera Cable/Connectors, GPS Module, and LPCS Software, 2 Traffic cameras, 1 Parking camera, NoWiFi, Stand Alone, 7m cable.	\$14,500.00	\$13,148.61
334220	Neology	MS374-3110-105	PIPS Technology 3 Camera Mobile System, to include 3 P720 Cameras with 740nm illumination, SX4e Mobile Processor, Camera Cable/Connectors, GPS Module, and LPCS Software, 2 Traffic cameras, 1 Parking camera, WiFi, VP Relay, 5m cable.	\$14,350.00	\$13,012.59
334220	Neology	MS374-3110-107	PIPS Technology 3 Camera Mobile System, to include 3 P720 Cameras with 740nm illumination, SX4e Mobile Processor, Camera Cable/Connectors, GPS Module, and LPCS Software, 2 Traffic cameras, 1 Parking camera, WiFi, VP Relay, 7m cable.	\$14,500.00	\$13,148.61
334220	Neology	MS374-3110-115	PIPS Technology 3 Camera Mobile System, to include 3 P720 Cameras with 740nm illumination, SX4e Mobile Processor, Camera Cable/Connectors, GPS Module, and LPCS Software, 2 Traffic cameras, 1 Parking camera, WiFi, Stand Alone, 5m cable.	\$14,350.00	\$13,012.59
334220	Neology	MS374-3110-117	PIPS Technology 3 Camera Mobile System, to include 3 P720 Cameras with 740nm illumination, SX4e Mobile Processor, Camera Cable/Connectors, GPS Module, and LPCS Software, 2 Traffic cameras, 1 Parking camera, WiFi, Stand Alone, 7m cable.	\$14,500.00	\$13,148.61
334220	Neology	MS374-3310-005	PIPS Technology 3 Camera Mobile System, to include 3 P720 Cameras with 740nm illumination, SX4e Mobile Processor, Camera Cable/Connectors, GPS Module, and LPCS Software, 1 Traffic camera, 2 Parking cameras, No WiFi, VP Relay, 5m cable.	\$14,350.00	\$13,012.59
334220	Neology	MS374-3310-007	PIPS Technology 3 Camera Mobile System, to include 3 P720 Cameras with 740nm illumination, SX4e Mobile Processor, Camera Cable/Connectors, GPS Module, and LPCS Software, 1 Traffic camera, 2 Parking cameras, No WiFi, VP Relay, 7m cable.	\$14,500.00	\$13,148.61
334220	Neology	MS374-3310-015	PIPS Technology 3 Camera Mobile System, to include 3 P720 Cameras with 740nm illumination, SX4e Mobile Processor, Camera Cable/Connectors, GPS Module, and LPCS Software, 1 Traffic camera, 2 Parking cameras, No WiFi, Stand Alone, 5m cable.	\$14,350.00	\$13,012.59
334220	Neology	MS374-3310-017	PIPS Technology 3 Camera Mobile System, to include 3 P720 Cameras with 740nm illumination, SX4e Mobile Processor, Camera Cable/Connectors, GPS Module, and LPCS Software, 1 Traffic camera, 2 Parking cameras, No WiFi, Stand Alone, 7m cable.	\$14,500.00	\$13,148.61
334220	Neology	MS374-3310-105	PIPS Technology 3 Camera Mobile System, to include 3 P720 Cameras with 740nm illumination, SX4e Mobile Processor, Camera Cable/Connectors, GPS Module, and LPCS Software, 1 Traffic camera, 2 Parking cameras, WiFi, VP Relay, 5m cable.	\$14,350.00	\$13,012.59
334220	Neology	MS374-3310-107	PIPS Technology 3 Camera Mobile System, to include 3 P720 Cameras with 740nm illumination, SX4e Mobile Processor, Camera Cable/Connectors, GPS Module, and LPCS Software, 1 Traffic camera, 2 Parking cameras, WiFi, VP Relay, 7m cable.	\$14,500.00	\$13,148.61
334220	Neology	MS374-3310-115	PIPS Technology 3 Camera Mobile System, to include 3 P720 Cameras with 740nm illumination, SX4e Mobile Processor, Camera Cable/Connectors, GPS Module, and LPCS Software, 1 Traffic camera, 2 Parking cameras, WiFi, Stand Alone, 5m cable.	\$14,350.00	\$13,012.59
334220	Neology	MS374-3310-117	PIPS Technology 3 Camera Mobile System, to include 3 P720 Cameras with 740nm illumination, SX4e Mobile Processor, Camera Cable/Connectors, GPS Module, and LPCS Software, 1 Traffic camera, 2 Parking cameras, WiFi, Stand Alone, 7m cable.	\$14,500.00	\$13,148.61
334220	Neology	MS374-3330-005	PIPS Technology 3 Camera Mobile System, to include 3 P720 Cameras with 740nm illumination, SX4e Mobile Processor, Camera Cable/Connectors, GPS Module, and LPCS Software, 3 Parking cameras, No WiFi, VP Relay, 5m cable.	\$14,350.00	\$13,012.59
334220	Neology	MS374-3330-007	PIPS Technology 3 Camera Mobile System, to include 3 P720 Cameras with 740nm illumination, SX4e Mobile Processor, Camera Cable/Connectors, GPS Module, and LPCS Software, 3 Parking cameras, No WiFi, VP Relay, 7m cable.	\$14,500.00	\$13,148.61





334220	Neology	MS381-3110-017	PIPS Technology 3 Camera Mobile System, to include 3 P720 Cameras with 810nm illumination, SX4e Mobile Processor, Camera Cable/Connectors, GPS Module, and LPCS Software, 2 Traffic cameras, 1 Parking camera, No WiFi, Stand Alone, 7m cable.	\$14,500.00	\$13,148.61
334220	Neology	MS381-3110-105	PIPS Technology 3 Camera Mobile System, to include 3 P720 Cameras with 810nm illumination, SX4e Mobile Processor, Camera Cable/Connectors, GPS Module, and LPCS Software, 2 Traffic cameras, 1 Parking camera, WiFi, VP Relay, 5m cable.	\$14,350.00	\$13,012.59
334220	Neology	MS381-3110-107	PIPS Technology 3 Camera Mobile System, to include 3 P720 Cameras with 810nm illumination, SX4e Mobile Processor, Camera Cable/Connectors, GPS Module, and LPCS Software, 2 Traffic cameras, 1 Parking camera, WiFi, VP Relay, 7m cable.	\$14,500.00	\$13,148.61
334220	Neology	MS381-3110-115	PIPS Technology 3 Camera Mobile System, to include 3 P720 Cameras with 810nm illumination, SX4e Mobile Processor, Camera Cable/Connectors, GPS Module, and LPCS Software, 2 Traffic cameras, 1 Parking camera, WiFi, Stand Alone, 5m cable.	\$14,350.00	\$13,012.59
334220	Neology	MS381-3110-117	PIPS Technology 3 Camera Mobile System, to include 3 P720 Cameras with 810nm illumination, SX4e Mobile Processor, Camera Cable/Connectors, GPS Module, and LPCS Software, 2 Traffic cameras, 1 Parking camera, WiFi, Stand Alone, 7m cable.	\$14,500.00	\$13,148.61
334220	Neology	MS381-3310-005	PIPS Technology 3 Camera Mobile System, to include 3 P720 Cameras with 810nm illumination, SX4e Mobile Processor, Camera Cable/Connectors, GPS Module, and LPCS Software, 1 Traffic camera, 2 Parking camera, No WiFi, VP Relay, 5m cable.	\$14,350.00	\$13,012.59
334220	Neology	MS381-3310-007	PIPS Technology 3 Camera Mobile System, to include 3 P720 Cameras with 810nm illumination, SX4e Mobile Processor, Camera Cable/Connectors, GPS Module, and LPCS Software, 1 Traffic camera, 2 Parking camera, No WiFi, VP Relay, 7m cable.	\$14,500.00	\$13,148.61
334220	Neology	MS381-3310-015	PIPS Technology 3 Camera Mobile System, to include 3 P720 Cameras with 810nm illumination, SX4e Mobile Processor, Camera Cable/Connectors, GPS Module, and LPCS Software, 1 Traffic camera, 2 Parking camera, No WiFi, Stand Alone, 5m cable.	\$14,350.00	\$13,012.59
334220	Neology	MS381-3310-017	PIPS Technology 3 Camera Mobile System, to include 3 P720 Cameras with 810nm illumination, SX4e Mobile Processor, Camera Cable/Connectors, GPS Module, and LPCS Software, 1 Traffic camera, 2 Parking camera, No WiFi, Stand Alone, 7m cable.	\$14,500.00	\$13,148.61
334220	Neology	MS381-3310-105	PIPS Technology 3 Camera Mobile System, to include 3 P720 Cameras with 810nm illumination, SX4e Mobile Processor, Camera Cable/Connectors, GPS Module, and LPCS Software, 1 Traffic camera, 2 Parking camera, WiFi, VP Relay, 5m cable.	\$14,350.00	\$13,012.59
334220	Neology	MS381-3310-107	PIPS Technology 3 Camera Mobile System, to include 3 P720 Cameras with 810nm illumination, SX4e Mobile Processor, Camera Cable/Connectors, GPS Module, and LPCS Software, 1 Traffic camera, 2 Parking camera, WiFi, VP Relay, 7m cable.	\$14,500.00	\$13,148.61
334220	Neology	MS381-3310-115	PIPS Technology 3 Camera Mobile System, to include 3 P720 Cameras with 810nm illumination, SX4e Mobile Processor, Camera Cable/Connectors, GPS Module, and LPCS Software, 1 Traffic camera, 2 Parking camera, WiFi, Stand Alone, 5m cable.	\$14,350.00	\$13,012.59
334220	Neology	MS381-3310-117	PIPS Technology 3 Camera Mobile System, to include 3 P720 Cameras with 810nm illumination, SX4e Mobile Processor, Camera Cable/Connectors, GPS Module, and LPCS Software, 1 Traffic camera, 2 Parking camera, WiFi, Stand Alone, 7m cable.	\$14,500.00	\$13,148.61
334220	Neology	MS381-3330-005	PIPS Technology 3 Camera Mobile System, to include 3 P720 Cameras with 810nm illumination, SX4e Mobile Processor, Camera Cable/Connectors, GPS Module, and LPCS Software, 3 Parking camera, No WiFi, VP Relay, 5m cable.	\$14,350.00	\$13,012.59
334220	Neology	MS381-3330-007	PIPS Technology 3 Camera Mobile System, to include 3 P720 Cameras with 810nm illumination, SX4e Mobile Processor, Camera Cable/Connectors, GPS Module, and LPCS Software, 3 Parking camera, No WiFi, VP Relay, 7m cable.	\$14,500.00	\$13,148.61





334220	Neology	MS394-3330-017	PIPS Technology 3 Camera Mobile System, to include 3 P720 Cameras with 940nm illumination, SX4e Mobile Processor, Camera Cable/Connectors, GPS Module, and LPCS Software, 3 Parking camera, No WiFi, Stand Alone, 7m cable.	\$14,500.00	\$13,148.61
334220	Neology	MS394-3330-105	PIPS Technology 3 Camera Mobile System, to include 3 P720 Cameras with 940nm illumination, SX4e Mobile Processor, Camera Cable/Connectors, GPS Module, and LPCS Software, 3 Parking camera, WiFi, VP Relay, 5m cable.	\$14,350.00	\$13,012.59
334220	Neology	MS394-3330-107	PIPS Technology 3 Camera Mobile System, to include 3 P720 Cameras with 940nm illumination, SX4e Mobile Processor, Camera Cable/Connectors, GPS Module, and LPCS Software, 3 Parking camera, WiFi, VP Relay, 7m cable.	\$14,500.00	\$13,148.61
334220	Neology	MS394-3330-115	PIPS Technology 3 Camera Mobile System, to include 3 P720 Cameras with 940nm illumination, SX4e Mobile Processor, Camera Cable/Connectors, GPS Module, and LPCS Software, 3 Parking camera, WiFi, Stand Alone, 5m cable.	\$14,350.00	\$13,012.59
334220	Neology	MS394-3330-117	PIPS Technology 3 Camera Mobile System, to include 3 P720 Cameras with 940nm illumination, SX4e Mobile Processor, Camera Cable/Connectors, GPS Module, and LPCS Software, 3 Parking camera, WiFi, Stand Alone, 7m cable.	\$14,500.00	\$13,148.61
334220	Neology	MS474-1111-005	PIPS Technology 4 Camera Mobile System, to include 4 P720 Cameras with 740nm illumination, SX4e Mobile Processor, Camera Cable/Connectors, GPS Module, and LPCS Software, 4 Traffic camera, No WiFi, VP Relay, 5m cable.	\$17,450.00	\$15,823.68
334220	Neology	MS474-1111-007	PIPS Technology 4 Camera Mobile System, to include 4 P720 Cameras with 740nm illumination, SX4e Mobile Processor, Camera Cable/Connectors, GPS Module, and LPCS Software, 4 Traffic camera, No WiFi, VP Relay, 7m cable.	\$17,650.00	\$16,005.04
334220	Neology	MS474-1111-015	PIPS Technology 4 Camera Mobile System, to include 4 P720 Cameras with 740nm illumination, SX4e Mobile Processor, Camera Cable/Connectors, GPS Module, and LPCS Software, 4 Traffic camera, No WiFi, Stand Alone, 5m cable.	\$17,450.00	\$15,823.68
334220	Neology	MS474-1111-017	PIPS Technology 4 Camera Mobile System, to include 4 P720 Cameras with 740nm illumination, SX4e Mobile Processor, Camera Cable/Connectors, GPS Module, and LPCS Software, 4 Traffic camera, No WiFi, Stand Alone, 7m cable.	\$17,650.00	\$16,005.04
334220	Neology	MS474-1111-105	PIPS Technology 4 Camera Mobile System, to include 4 P720 Cameras with 740nm illumination, SX4e Mobile Processor, Camera Cable/Connectors, GPS Module, and LPCS Software, 4 Traffic camera, WiFi, VP Relay, 5m cable.	\$17,450.00	\$15,823.68
334220	Neology	MS474-1111-107	PIPS Technology 4 Camera Mobile System, to include 4 P720 Cameras with 740nm illumination, SX4e Mobile Processor, Camera Cable/Connectors, GPS Module, and LPCS Software, 4 Traffic camera, WiFi, VP Relay, 7m cable.	\$17,650.00	\$16,005.04
334220	Neology	MS474-1111-115	PIPS Technology 4 Camera Mobile System, to include 4 P720 Cameras with 740nm illumination, SX4e Mobile Processor, Camera Cable/Connectors, GPS Module, and LPCS Software, 4 Traffic camera, WiFi, Stand Alone, 5m cable.	\$17,450.00	\$15,823.68
334220	Neology	MS474-1111-117	PIPS Technology 4 Camera Mobile System, to include 4 P720 Cameras with 740nm illumination, SX4e Mobile Processor, Camera Cable/Connectors, GPS Module, and LPCS Software, 4 Traffic camera, WiFi, Stand Alone, 7m cable.	\$17,650.00	\$16,005.04
334220	Neology	MS474-3111-005	PIPS Technology 4 Camera Mobile System, to include 4 P720 Cameras with 740nm illumination, SX4e Mobile Processor, Camera Cable/Connectors, GPS Module, and LPCS Software, 3 Traffic camera, 1 Parking camera, No WiFi, VP Relay, 5m cable.	\$17,450.00	\$15,823.68
334220	Neology	MS474-3111-007	PIPS Technology 4 Camera Mobile System, to include 4 P720 Cameras with 740nm illumination, SX4e Mobile Processor, Camera Cable/Connectors, GPS Module, and LPCS Software, 3 Traffic camera, 1 Parking camera, No WiFi, VP Relay, 7m cable.	\$17,650.00	\$16,005.04
334220	Neology	MS474-3111-015	PIPS Technology 4 Camera Mobile System, to include 4 P720 Cameras with 740nm illumination, SX4e Mobile Processor, Camera Cable/Connectors, GPS Module, and LPCS Software, 3 Traffic camera, 1 Parking camera, No WiFi, Stand Alone, 5m cable.	\$17,450.00	\$15,823.68
334220	Neology	MS474-3111-017	PIPS Technology 4 Camera Mobile System, to include 4 P720 Cameras with 740nm illumination, SX4e Mobile Processor, Camera Cable/Connectors, GPS Module, and LPCS Software, 3 Traffic camera, 1 Parking camera, No WiFi, Stand Alone, 7m cable.	\$17,650.00	\$16,005.04















334220	Neology	MS494-3331-017	PIPS Technology 4 Camera Mobile System, to include 4 P720 Cameras with 940nm illumination, SX4e Mobile Processor, Camera Cable/Connectors, GPS Module, and LPCS Software, 1 Traffic camera, 3 Parking camera, No WiFi, Stand Alone, 7m cable.	\$17,650.00	\$16,005.04
334220	Neology	MS494-3331-105	PIPS Technology 4 Camera Mobile System, to include 4 P720 Cameras with 940nm illumination, SX4e Mobile Processor, Camera Cable/Connectors, GPS Module, and LPCS Software, 1 Traffic camera, 3 Parking camera, WiFi, VP Relay, 5m cable.	\$17,450.00	\$15,823.68
334220	Neology	MS494-3331-107	PIPS Technology 4 Camera Mobile System, to include 4 P720 Cameras with 940nm illumination, SX4e Mobile Processor, Camera Cable/Connectors, GPS Module, and LPCS Software, 1 Traffic camera, 3 Parking camera, WiFi, VP Relay, 7m cable.	\$17,650.00	\$16,005.04
334220	Neology	MS494-3331-115	PIPS Technology 4 Camera Mobile System, to include 4 P720 Cameras with 940nm illumination, SX4e Mobile Processor, Camera Cable/Connectors, GPS Module, and LPCS Software, 1 Traffic camera, 3 Parking camera, WiFi, Stand Alone, 5m cable.	\$17,450.00	\$15,823.68
334220	Neology	MS494-3331-117	PIPS Technology 4 Camera Mobile System, to include 4 P720 Cameras with 940nm illumination, SX4e Mobile Processor, Camera Cable/Connectors, GPS Module, and LPCS Software, 1 Traffic camera, 3 Parking camera, WiFi, Stand Alone, 7m cable.	\$17,650.00	\$16,005.04
334220	Neology	MS494-3333-005	PIPS Technology 4 Camera Mobile System, to include 4 P720 Cameras with 940nm illumination, SX4e Mobile Processor, Camera Cable/Connectors, GPS Module, and LPCS Software, 4 Parking camera, No WiFi, VP Relay, 5m cable.	\$17,450.00	\$15,823.68
334220	Neology	MS494-3333-007	PIPS Technology 4 Camera Mobile System, to include 4 P720 Cameras with 940nm illumination, SX4e Mobile Processor, Camera Cable/Connectors, GPS Module, and LPCS Software, 4 Parking camera, No WiFi, VP Relay, 7m cable.	\$17,650.00	\$16,005.04
334220	Neology	MS494-3333-015	PIPS Technology 4 Camera Mobile System, to include 4 P720 Cameras with 940nm illumination, SX4e Mobile Processor, Camera Cable/Connectors, GPS Module, and LPCS Software, 4 Parking camera, No WiFi, Stand Alone, 5m cable.	\$17,450.00	\$15,823.68
334220	Neology	MS494-3333-017	PIPS Technology 4 Camera Mobile System, to include 4 P720 Cameras with 940nm illumination, SX4e Mobile Processor, Camera Cable/Connectors, GPS Module, and LPCS Software, 4 Parking camera, No WiFi, Stand Alone, 7m cable.	\$17,650.00	\$16,005.04
334220	Neology	MS494-3333-105	PIPS Technology 4 Camera Mobile System, to include 4 P720 Cameras with 940nm illumination, SX4e Mobile Processor, Camera Cable/Connectors, GPS Module, and LPCS Software, 4 Parking camera, WiFi, VP Relay, 5m cable.	\$17,450.00	\$15,823.68
334220	Neology	MS494-3333-107	PIPS Technology 4 Camera Mobile System, to include 4 P720 Cameras with 940nm illumination, SX4e Mobile Processor, Camera Cable/Connectors, GPS Module, and LPCS Software, 4 Parking camera, WiFi, VP Relay, 7m cable.	\$17,650.00	\$16,005.04
334220	Neology	MS494-3333-115	PIPS Technology 4 Camera Mobile System, to include 4 P720 Cameras with 940nm illumination, SX4e Mobile Processor, Camera Cable/Connectors, GPS Module, and LPCS Software, 4 Parking camera, WiFi, Stand Alone, 5m cable.	\$17,450.00	\$15,823.68
334220	Neology	MS494-3333-117	PIPS Technology 4 Camera Mobile System, to include 4 P720 Cameras with 940nm illumination, SX4e Mobile Processor, Camera Cable/Connectors, GPS Module, and LPCS Software, 4 Parking camera, WiFi, Stand Alone, 7m cable.	\$17,650.00	\$16,005.04
334220	Neology	SB1400001001	BOSS 4.0 Level1, 1 year license	\$1,695.00	\$1,537.03
334220	Neology	SB1400002001	BOSS 4.0 Level2, 1 year license	\$3,395.00	\$3,078.59
334220	Neology	SB1400003001	BOSS 4.0 Level3, 1 year license	\$5,095.00	\$4,620.15
334220	Neology	SB1400004001	BOSS 4.0 Level4, 1 year license	\$6,795.00	\$6,161.71
334220	Neology	SB1400005001	BOSS 4.0 Level5, 1 year license	\$9,495.00	\$8,610.08
334220	Neology	SB1400006001	BOSS 4.0 Level6, 1 year license	\$10,195.00	\$9,244.84
334220	Neology	SB1400301101	BOSS 4.0 AWS-USA Hosting Level 1, 1 Year License	\$4,995.00	\$4,529.47
334220	Neology	SB1400301201	BOSS 4.0 AWS-USA Hosting Level 2, 1 Year License	\$12,495.00	\$11,330.48
334220	Neology	SB1400301301	BOSS 4.0 AWS-USA Hosting Level 3, 1 Year License	\$27,995.00	\$25,385.89
334220	Neology	SB1400301401	BOSS 4.0 AWS-USA Hosting Level 4, 1 Year License	\$48,795.00	\$44,247.36
334220	Neology	SB1400301501	BOSS 4.0 AWS-USA Hosting Level 5, 1 Year License	\$69,500.00	\$63,022.67
334220	Neology	SB1410001002	BOSS Mantis Level 2, 1 Yr, <3.75M	\$5,000.00	\$4,534.01
334220	Neology	SB1410001003	BOSS Mantis Level 3, 1 Yr, <7.5M	\$10,000.00	\$9,068.01
334220	Neology	SB1410001004	BOSS Mantis Level 4, 1 Yr, <25M	\$25,000.00	\$22,670.03
334220	Neology	WF5001000112	Ext Warranty - Iris Seriew P500 BO 1 Year	\$1,950.00	\$1,768.26
334220	Neology	WM120-1000-112	P720 Ext. Warranty-Mob/Port 2Cam/Car 1 YR	\$1,300.00	\$1,178.84

334220	Neology	WM130-1000-112	P720 Ext. Warranty-Mob/Port 3Cam/Car 1 YR	\$1,400.00	\$1,269.52
334220	Neology	WM140-1000-112	P720 Ext. Warranty-Mob/Port 4Cam/Car 1 YR	\$1,500.00	\$1,360.20
334220	Neology	WM2020000112	Ext Warranty Sx4 Processor (per processor) BO 1 Year	\$826.00	\$749.02
334220	Neology	WM3010001112	Extended Warranty Sx4e Processsor, BO 1 year	\$826.00	\$749.02
336320	Neology	WM4010001112	Extended Warranty, P720 Camera, BO, 1 year	\$392.00	\$355.47
336320	TruckVault Inc.	C-AMHH1N3-94N-CR	H1 Field Ranger	\$3,945.00	\$3,378.59
336320	TruckVault Inc.	C-AMHH1N3-94R-BT-PW	H1 A/W Field Ranger	\$3,245.00	\$2,779.09
336320	TruckVault Inc.	C-BKENCN3-08I	Buick Enclave Investigator, dimensions: 0L x 0W	\$3,825.00	\$3,275.82
336320	TruckVault Inc.	C-BKRENN3-05D	Buick Rendezvous Special Op Ctr, dimensions: 0L x 0W	\$3,725.00	\$3,190.18
336320	TruckVault Inc.	C-BWX5NN2-14N-ZC8183	X5 Cust 2 Dwr	\$2,885.00	\$2,470.78
336320	TruckVault Inc.	C-CAESCN3-07D-PT	Cadillac Escalade Special Ops Ctr, dimensions: 30.125L x 48W	\$4,420.00	\$3,785.39
336320	TruckVault Inc.	C-CAESCN3-07I	Cadillac Escalade Investigator, dimensions: 30.125L x 48W	\$3,725.00	\$3,190.18
336320	TruckVault Inc.	C-CAESCN3-12D-PT	Cadillac Escalade Special Ops Ctr, dimensions: 30.125L x 48W	\$4,420.00	\$3,785.39
336320	TruckVault Inc.	C-CAESCN3-12I	Cadillac Escalade Investigator, dimensions: 30.125L x 48W	\$3,725.00	\$3,190.18
336320	TruckVault Inc.	C-CAESCN3-12R	Escalade Field Ranger	\$3,245.00	\$2,779.09
336320	TruckVault Inc.	C-CAESCN3-97I	Cadillac Escalade Investigator, dimensions: 43L x 48W	\$3,825.00	\$3,275.82
336320	TruckVault Inc.	C-CAESCN5-96C	Cadillac Escalade Chief LX CC, dimensions: 30.125L x 48W	\$4,545.00	\$3,892.44
336320	TruckVault Inc.	C-CAESCN6-00T	Cadillac Escalade Tac Ctr, dimensions: 30.125L x 48W	\$4,845.00	\$4,149.37
336320	TruckVault Inc.	C-CAESCN6-96C	Cadillac Escalade Chief LX CC, dimensions: 30.125L x 48W	\$4,845.00	\$4,149.37
336320	TruckVault Inc.	C-CAXT5N3-17I-PT	XT5 InvestigatorPullout Table	\$4,420.00	\$3,785.39
336320	TruckVault Inc.	C-CHAVALN3-02R	Chevrolet Avalanche SUT Field Ranger, dimensions: 61L x 53W	\$3,645.00	\$3,121.66
336320	TruckVault Inc.	C-CHCSEN3-02C	Chevrolet Avalanche Chief LX CC, dimensions: 30.125L x 48W	\$4,545.00	\$3,892.44
336320	TruckVault Inc.	C-CHAVALN6-02C	Chevrolet Avalanche Chief LX CC, dimensions: 30.125L x 48W	\$4,845.00	\$4,149.37
336320	TruckVault Inc.	C-CHBLAN3-95R	Chevrolet Blazer Full Size Field Ranger, dimensions: 35L x 36W	\$2,545.00	\$2,179.60
336320	TruckVault Inc.	C-CHCEXN6-15C	City Express Van Chief LX CC	\$4,845.00	\$4,149.37
336320	TruckVault Inc.	C-CHCOLMO-15S-VP	Colorado Pickup Surveyor	\$3,725.00	\$3,190.18
336320	TruckVault Inc.	C-CHCOLN3-15S-CR	Colorado Pickup Field Ranger	\$3,995.00	\$3,421.41
336320	TruckVault Inc.	C-CHCOLN3-15S-PC-CR-PW	Colorado Pickup Field Ranger5' Bed; Crew Cab; A/W	\$4,305.00	\$3,686.90
336320	TruckVault Inc.	C-CHCSEN3-88L-CR-PW	Silverado Pickup AW Field Ranger	\$5,495.00	\$4,706.05
336320	TruckVault Inc.	C-CHCSEN5-99C	Chevrolet Silverado Chief LX CC, dimensions: 30.125L x 48W	\$4,545.00	\$3,892.44
336320	TruckVault Inc.	C-CHCSEN6-99C	Chevrolet Silverado Chief LX CC, dimensions: 30.125L x 48W	\$4,845.00	\$4,149.37
336320	TruckVault Inc.	C-CHEQXN2-10D-HT	Equinox Special Ops HD TableTray/3rd Removed	\$3,920.00	\$3,357.18
336320	TruckVault Inc.	C-CHEQXN2-10I	Equinox Investigator	\$3,225.00	\$2,761.96
336320	TruckVault Inc.	C-CHEQXN2-10I-HT	Equinox Investigator 2 Dwr HD TableInvestigator, 1 Dwr Bot	\$3,920.00	\$3,357.18
336320	TruckVault Inc.	C-CHEQXN2-18I	Equinox Investigator	\$3,225.00	\$2,761.96
336320	TruckVault Inc.	C-CHEQXN3-05I	Chevrolet Equinox Investigator, dimensions: 29.5L x 34.75W	\$3,725.00	\$3,190.18
336320	TruckVault Inc.	C-CHEQXN3-05I-PT	Equinox Investigator	\$4,420.00	\$3,785.39
336320	TruckVault Inc.	C-CHEQXN3-10D-HT	Equinox Special Ops HD Table	\$4,420.00	\$3,785.39
336320	TruckVault Inc.	C-CHEQXN3-10I	Chevrolet Equinox Investigator, dimensions: 28L x 37W	\$3,725.00	\$3,190.18
336320	TruckVault Inc.	C-CHEQXN3-10I-PT	Chevrolet Equinox Investigator, dimensions: 27L x 37W	\$4,420.00	\$3,785.39
336320	TruckVault Inc.	C-CHEQXN3-10R	Chevrolet Equinox Field Ranger, dimensions: 0L x 0W	\$3,045.00	\$2,607.81
336320	TruckVault Inc.	C-CHEQXN3-18I-HT	Equinox InvestigatorHD Table Extension	\$4,420.00	\$3,785.39
336320	TruckVault Inc.	C-CHEQXN3-18I-PT	Equinox Investigator	\$4,420.00	\$3,785.39
336320	TruckVault Inc.	C-CHEXPM2-03N-PT-VP	Chevrolet Full Size Surveyor, Tbl Ext, dimensions: 60L x 48W	\$4,635.00	\$3,969.52
336320	TruckVault Inc.	C-CHEXPN3-16N-ZC8236	Chevy Express Van Cust 3 Dwr	\$5,095.00	\$4,363.48
336320	TruckVault Inc.	C-CHEXPN4-03N-PT-VP	Full Size Surveyor	\$6,315.00	\$5,408.31
336320	TruckVault Inc.	C-CHEXPN4-03N-VP	Chevrolet Full Size Surveyor, dimensions: 60L x 48W	\$4,935.00	\$4,226.45
336320	TruckVault Inc.	C-CHEXPN5-03P-HT	Full Size Van Captain LX CCHeavy Duty Table	\$4,790.00	\$4,102.27
336320	TruckVault Inc.	C-CHSBLN5-95C	Chevrolet S-10 Blazer Chief LX CC, dimensions: 25L x 38W	\$4,545.00	\$3,892.44
336320	TruckVault Inc.	C-CHSILM2-07L-VP	Chevrolet Silverado Pickup Surveyor, dimensions: 96L x 48W	\$4,325.00	\$3,704.03
336320	TruckVault Inc.	C-CHSILM2-07S-PC-VP	Chevrolet Silverado Pickup Surveyor, dimensions: 76L x 48W	\$3,905.00	\$3,344.33
336320	TruckVault Inc.	C-CHSILM2-07S-VP	Silverado Pickup Surveyor	\$4,115.00	\$3,524.18
336320	TruckVault Inc.	C-CHSILM2-07S-ZC8677	Silverado Pickup Mag 2 Dwr Stack	\$3,235.00	\$2,770.53
336320	TruckVault Inc.	C-CHSILM2-20L-P5-VP	Silverado Pickup Surveyor	\$4,125.00	\$3,532.75
336320	TruckVault Inc.	C-CHSILM2-20S-P5-VP	Silverado Pickup Surveyor	\$4,025.00	\$3,447.10
336320	TruckVault Inc.	C-CHSILN1-20S-P5-C4-ZC11334A	Silverado Pickup Custom	\$3,215.00	\$2,753.40
336320	TruckVault Inc.	C-CHSILN2-15S-PC-ZC10079	Silverado Cab CustomC10079	\$5,315.00	\$4,551.89
336320	TruckVault Inc.	C-CHSILN2-19S-HD-ZC10202	Silverado Pickup 2 Dwr 1/2 Width Stacked	\$3,080.00	\$2,637.78
336320	TruckVault Inc.	C-CHSILN2-19S-PC-HN-PW-ZC10019	Silverado Pickup Half WidthC10019	\$4,595.00	\$3,935.26
336320	TruckVault Inc.	C-CHSILN2-19S-PC-HN-PW-ZC10264	Silverado CustomC10264	\$3,695.00	\$3,164.48
336320	TruckVault Inc.	C-CHSILN2-19S-PC-HN-PW-ZC10712	Silverado Pickup Half WidthC10712	\$4,315.00	\$3,695.47
336320	TruckVault Inc.	C-CHSILN2-20L-P5-C2-ZC10679B	Silverado Pickup Custom8' 2500	\$4,265.00	\$3,652.64
336320	TruckVault Inc.	C-CHSILN2-20S-P5-PW-ZC10480	Silverado Pickup 2 Dwr 1/2 Width Stacked6' 6" Short Bed, A-Wthr (New) Shortened to 66"	\$3,685.00	\$3,155.92
336320	TruckVault Inc.	C-CHSILN3-07L-BH-PW	Silverado Pickup BowHunter	\$5,145.00	\$4,406.30
336320	TruckVault Inc.	C-CHSILN3-07L-CR	Chevrolet Silverado Pickup Field Ranger, dimensions: 95L x 48W	\$4,745.00	\$4,063.73

336320	TruckVault Inc.	C-CHSILN3-07L-CR-PW	Silverado Pickup Field Ranger	\$5,495.00	\$4,706.05
336320	TruckVault Inc.	C-CHSILN3-07S-BH	Chevrolet Silverado Pickup BowHunter, dimensions: 76L x 48W	\$4,195.00	\$3,592.70
336320	TruckVault Inc.	C-CHSILN3-07S-CR-PW	Silverado AW Field Ranger	\$5,195.00	\$4,449.12
336320	TruckVault Inc.	C-CHSILN3-07S-PC-BH	Chevrolet Silverado Pickup BowHunter, dimensions: 64.75L x 53W	\$3,995.00	\$3,421.41
336320	TruckVault Inc.	C-CHSILN3-07S-PC-BH-PW	Silverado Pickup BowHunter	\$4,545.00	\$3,892.44
336320	TruckVault Inc.	C-CHSILN3-07S-PC-CR	Silverado Pickup Field Ranger	\$4,345.00	\$3,721.16
336320	TruckVault Inc.	C-CHSILN3-07S-PC-CR-PW	Silverado Pickup Field Ranger	\$4,895.00	\$4,192.19
336320	TruckVault Inc.	C-CHSILN3-07S-PC-ZC11188	Silverado Pickup CustomC11188; In-Cab	\$2,505.00	\$2,145.34
336320	TruckVault Inc.	C-CHSILN3-19S-C3-ZC8917	Silverado Pickup Custom	\$4,975.00	\$4,260.71
336320	TruckVault Inc.	C-CHSILN3-19S-CR	Silverado Pickup Field Ranger	\$4,545.00	\$3,892.44
336320	TruckVault Inc.	C-CHSILN3-19S-CR-PL-PW	Silverado AW Field Ranger6' 6" Bed; Logo	\$5,195.00	\$4,449.12
336320	TruckVault Inc.	C-CHSILN3-19S-CR-PW	Silverado AW Field Ranger6' 6" Bed	\$5,195.00	\$4,449.12
336320	TruckVault Inc.	C-CHSILN3-19S-PC-CR	Silverado Pickup Field Ranger5' 6" Bed; Crew Cab	\$4,085.00	\$3,498.49
336320	TruckVault Inc.	C-CHSILN3-19S-PC-CR-PW	Silverado Pickup Field Ranger	\$4,895.00	\$4,192.19
336320	TruckVault Inc.	C-CHSILN3-20L-P5-CR	Silverado HD Pickup Field Ranger	\$4,045.00	\$3,464.23
336320	TruckVault Inc.	C-CHSILN3-20S-P5-CR	Silverado HD Pickup Field Ranger	\$4,025.00	\$3,447.10
336320	TruckVault Inc.	C-CHSILN4-07L-C4-ZC9161	Silverado Pickup Surveyor	\$5,605.00	\$4,800.25
336320	TruckVault Inc.	C-CHSILN4-07S-C4-ZC9161	Silverado Pickup Surveyor	\$5,605.00	\$4,800.25
336320	TruckVault Inc.	C-CHSILN4-19S-C9491	Silverado CustomC9491	\$4,449.00	\$3,810.23
336320	TruckVault Inc.	C-CHSILN5-07S-CC	Silverado Chief LX CC	\$4,545.00	\$3,892.44
336320	TruckVault Inc.	C-CHSILN5-07S-TT-ZC7981	Silverado Pickup Cust	\$6,305.00	\$5,399.75
336320	TruckVault Inc.	C-CHSILS2-20L-P5-VP	Silverado Pickup Surveyor	\$3,925.00	\$3,361.46
336320	TruckVault Inc.	C-CHSILU2-19S-VP	Silverado Pickup Surveyor	\$5,895.00	\$5,048.61
336320	TruckVault Inc.	C-CHSILU2-19S-VP-ZC9812	Silverado Pickup Surveyor	\$4,635.00	\$3,969.52
336320	TruckVault Inc.	C-CHSUBM2-15F-VF	Chevrolet Suburban Surveyor, dimensions: 60L x 48W	\$3,905.00	\$3,344.33
336320	TruckVault Inc.	C-CHSUBM2-15F-VF-PT	Suburban Surveyor	\$4,565.00	\$3,909.57
336320	TruckVault Inc.	C-CHSUBM2-15N-HT-PP-ZC10471	Suburban CUSTC10471	\$4,475.00	\$3,832.49
336320	TruckVault Inc.	C-CHSUBM2-15N-ZC10529	Suburban 2 Mag Dwr StackedC10529	\$3,305.00	\$2,830.48
336320	TruckVault Inc.	C-CHSUBN0-15N-C10-ZC8803	Suburban Custom	\$2,255.00	\$1,931.23
336320	TruckVault Inc.	C-CHSUBN1-07N-C1-ZC10932B	Suburban CustomC10932B	\$2,795.00	\$2,393.70
336320	TruckVault Inc.	C-CHSUBN1-15N-C2-ZC10912F	Suburban CustomC10912F	\$3,215.00	\$2,753.40
336320	TruckVault Inc.	C-CHSUBN1-15N-C2-ZC8702	Suburban Custom	\$2,185.00	\$1,871.28
336320	TruckVault Inc.	C-CHSUBN1-15N-C3-ZC8612	Suburban Custom	\$2,525.00	\$2,162.47
336320	TruckVault Inc.	C-CHSUBN2-15N-C1-ZC9330	Suburban Custom	\$3,885.00	\$3,327.20
336320	TruckVault Inc.	C-CHSUBN2-15N-C2-TT-ZC10066	Suburban	\$4,215.00	\$3,609.82
336320	TruckVault Inc.	C-CHSUBN2-15N-C2-ZC8497	Suburban CUST	\$2,705.00	\$2,316.62
336320	TruckVault Inc.	C-CHSUBN2-15N-C2-ZC8994	Suburban Custom	\$3,385.00	\$2,898.99
336320	TruckVault Inc.	C-CHSUBN2-15N-C4-ZC8109	Suburban Custom	\$5,025.00	\$4,303.53
336320	TruckVault Inc.	C-CHSUBN2-15N-C4-ZC8679	Suburban Custom	\$5,045.00	\$4,320.65
336320	TruckVault Inc.	C-CHSUBN2-15N-HT-TT-C2-C10620C	Suburban Custom Drone Command CenterC10620C	\$4,995.00	\$4,277.83
336320	TruckVault Inc.	C-CHSUBN2-15N-TT-ZC10795B	Suburban CustomC10795B	\$6,635.00	\$5,682.37
336320	TruckVault Inc.	C-CHSUBN3-00D	Chevrolet Suburban Special Op Ctr, dimensions: 45L x 48W	\$3,825.00	\$3,275.82
336320	TruckVault Inc.	C-CHSUBN3-00D-PT	Chevrolet Suburban Special Op Ctr, dimensions: 45L x 48W	\$4,520.00	\$3,871.03
336320	TruckVault Inc.	C-CHSUBN3-00I	Chevrolet Suburban Investigator, dimensions: 54L x 48W	\$3,925.00	\$3,361.46
336320	TruckVault Inc.	C-CHSUBN3-00I-PT	Chevrolet Suburban Investigator, dimensions: 54L x 48W	\$4,620.00	\$3,956.68
336320	TruckVault Inc.	C-CHSUBN3-00N-C1-ZC9711	Suburban CustomC9711	\$2,605.00	\$2,230.98
336320	TruckVault Inc.	C-CHSUBN3-00R	Chevrolet Suburban Field Ranger, dimensions: 42.5L x 48W	\$3,245.00	\$2,779.09
336320	TruckVault Inc.	C-CHSUBN3-00R-LN	Chevrolet Suburban Field Ranger, dimensions: 42.5L x 48W	\$3,245.00	\$2,779.09
336320	TruckVault Inc.	C-CHSUBN3-00R-PT	Chevrolet Suburban Field Ranger, dimensions: 42.5L x 48W	\$3,940.00	\$3,374.31
336320	TruckVault Inc.	C-CHSUBN3-07D	Chevrolet Suburban Special Op Ctr, dimensions: 45L x 48W	\$3,825.00	\$3,275.82
336320	TruckVault Inc.	C-CHSUBN3-07D-PT	Chevrolet Suburban Special Op Ctr, dimensions: 45L x 48W	\$4,520.00	\$3,871.03
336320	TruckVault Inc.	C-CHSUBN3-07I	Chevrolet Suburban Investigator, dimensions: 52L x 48W	\$3,925.00	\$3,361.46
336320	TruckVault Inc.	C-CHSUBN3-07I-PT	Chevrolet Suburban Investigator, dimensions: 52L x 48W	\$4,620.00	\$3,956.68
336320	TruckVault Inc.	C-CHSUBN3-07R	Chevrolet Suburban Field Ranger, dimensions: 58L x 48W	\$3,445.00	\$2,950.38
336320	TruckVault Inc.	C-CHSUBN3-07R-PT	Chevrolet Suburban Field Ranger, dimensions: 58L x 48W	\$4,140.00	\$3,545.59
336320	TruckVault Inc.	C-CHSUBN3-12D	Chevrolet Suburban Special Op Ctr, dimensions: 58L x 48W	\$3,925.00	\$3,361.46
336320	TruckVault Inc.	C-CHSUBN3-12D-PT	Chevrolet Suburban Special Op Ctr, dimensions: 58L x 48W	\$4,620.00	\$3,956.68
336320	TruckVault Inc.	C-CHSUBN3-12I	Chevrolet Suburban Investigator, dimensions: 52L x 48W	\$3,925.00	\$3,361.46
336320	TruckVault Inc.	C-CHSUBN3-12I-PT	Chevrolet Suburban Investigator, dimensions: 52L x 48W	\$4,620.00	\$3,956.68
336320	TruckVault Inc.	C-CHSUBN3-12R	Chevrolet Suburban Field Ranger, dimensions: 58L x 48W	\$3,445.00	\$2,950.38
336320	TruckVault Inc.	C-CHSUBN3-12R-PT	Chevrolet Suburban Field Ranger, dimensions: 58L x 48W	\$4,140.00	\$3,545.59
336320	TruckVault Inc.	C-CHSUBN3-15D	Chevrolet Suburban Special Op Ctr, dimensions: 45L x 48W	\$3,925.00	\$3,361.46
336320	TruckVault Inc.	C-CHSUBN3-15D-PT	Chevrolet Suburban Special Op Ctr, dimensions: 45L x 48W	\$4,620.00	\$3,956.68
336320	TruckVault Inc.	C-CHSUBN3-15I-FP	Suburban Investigator	\$4,025.00	\$3,447.10
336320	TruckVault Inc.	C-CHSUBN3-15I-PT	Chevrolet Suburban Investigator, dimensions: 52L x 48W	\$4,620.00	\$3,956.68
336320	TruckVault Inc.	C-CHSUBN3-15M-ZC7763	Suburban Custom	\$3,785.00	\$3,241.56

336320	TruckVault Inc.	C-CHSUBN3-15N-C1-HT-ZC10254	Suburban CustomC10254	\$3,195.00	\$2,736.27
336320	TruckVault Inc.	C-CHSUBN3-15N-C1-TT-ZC11013D	Suburban CustomC11013D	\$5,575.00	\$4,774.56
336320	TruckVault Inc.	C-CHSUBN3-15N-C4-ZC9526	Suburban Custom	\$4,485.00	\$3,841.06
336320	TruckVault Inc.	C-CHSUBN3-15N-ZC10883	Suburban CustomC10883	\$3,565.00	\$3,053.15
336320	TruckVault Inc.	C-CHSUBN3-15N-ZC10920	Suburban CustomC10920	\$3,535.00	\$3,027.46
336320	TruckVault Inc.	C-CHSUBN3-15N-ZC9591B	Suburban CustomC9591B	\$3,005.00	\$2,573.55
336320	TruckVault Inc.	C-CHSUBN3-15R	Chevrolet Suburban Field Ranger, dimensions: 58L x 48W	\$3,445.00	\$2,950.38
336320	TruckVault Inc.	C-CHSUBN3-15R-HT	Suburban Field Ranger	\$4,140.00	\$3,545.59
336320	TruckVault Inc.	C-CHSUBN3-15R-PT	Chevrolet Suburban Field Ranger, dimensions: 58L x 48W	\$4,140.00	\$3,545.59
336320	TruckVault Inc.	C-CHSUBN3-15S-ZC8133	Suburban Cust C8133	\$2,935.00	\$2,513.60
336320	TruckVault Inc.	C-CHSUBN3-15S-ZC8797	Suburban Cust C8797	\$3,605.00	\$3,087.41
336320	TruckVault Inc.	C-CHSUBN3-21I-TF-HT	Suburban InvestigatorHD Table	\$4,620.00	\$3,956.68
336320	TruckVault Inc.	C-CHSUBN3-21N-TR-ZC11579	Suburban Custom	\$2,295.00	\$1,965.49
336320	TruckVault Inc.	C-CHSUBN3-88D	Suburban Special Op Ctr	\$3,925.00	\$3,361.46
336320	TruckVault Inc.	C-CHSUBN3-88R	Chevrolet Suburban Field Ranger, dimensions: 62.5L x 46W	\$3,645.00	\$3,121.66
336320	TruckVault Inc.	C-CHSUBN4-00P	Chevrolet Suburban Captain CC, dimensions: 30.125L x 48W	\$3,795.00	\$3,250.13
336320	TruckVault Inc.	C-CHSUBN4-00P-PT	Chevrolet Suburban Captain CC, dimensions: 30.125L x 48W	\$4,490.00	\$3,845.34
336320	TruckVault Inc.	C-CHSUBN4-07N-C4-ZC11182	Suburban CustomC11182	\$5,505.00	\$4,714.61
336320	TruckVault Inc.	C-CHSUBN4-07N-ZC9241	Suburban Custom	\$5,025.00	\$4,303.53
336320	TruckVault Inc.	C-CHSUBN4-12P	Chevrolet Suburban Captain CC, dimensions: 30.125L x 48W	\$3,795.00	\$3,250.13
336320	TruckVault Inc.	C-CHSUBN4-15N-C2-TT-ZC8480	Suburban Custom	\$5,365.00	\$4,594.71
336320	TruckVault Inc.	C-CHSUBN4-15N-C2-TT-ZC8672	Suburban Custom	\$5,365.00	\$4,594.71
336320	TruckVault Inc.	C-CHSUBN4-15N-C3-ZC10242	Suburban CustomC10242	\$6,435.00	\$5,511.08
336320	TruckVault Inc.	C-CHSUBN4-15P	Chevrolet Suburban Captain CC, dimensions: 30.125L x 48W	\$3,795.00	\$3,250.13
336320	TruckVault Inc.	C-CHSUBN5-00P	Chevrolet Suburban Captain LX CC, dimensions: 30.125L x 48W	\$4,095.00	\$3,507.05
336320	TruckVault Inc.	C-CHSUBN5-07C	Chevrolet Suburban Chief LX CC, dimensions: 30.125L x 48W	\$4,545.00	\$3,892.44
336320	TruckVault Inc.	C-CHSUBN5-07C-PT	Chevrolet Suburban Chief LX CC, dimensions: 30.125L x 48W	\$5,240.00	\$4,487.66
336320	TruckVault Inc.	C-CHSUBN5-07P	Chevrolet Suburban Captain LX CC, dimensions: 30.125L x 48W	\$4,095.00	\$3,507.05
336320	TruckVault Inc.	C-CHSUBN5-12C	Chevrolet Suburban Chief LX CC, dimensions: 30.125L x 48W	\$4,545.00	\$3,892.44
336320	TruckVault Inc.	C-CHSUBN5-12P	Chevrolet Suburban Captain LX CC, dimensions: 30.125L x 48W	\$4,095.00	\$3,507.05
336320	TruckVault Inc.	C-CHSUBN5-15N-C1-TT-ZC10487A	Suburban CustomC10487A	\$6,395.00	\$5,476.83
336320	TruckVault Inc.	C-CHSUBN5-15N-C1-ZC10430	Suburban CUSTC10430	\$4,615.00	\$3,952.39
336320	TruckVault Inc.	C-CHSUBN5-15P	Chevrolet Suburban Captain LX CC, dimensions: 30.125L x 48W	\$4,095.00	\$3,507.05
336320	TruckVault Inc.	C-CHSUBN5-15T-PT	Chevrolet Suburban Tac Ctr, dimensions: 30.125L x 48W	\$5,085.00	\$4,354.91
336320	TruckVault Inc.	C-CHSUBN5-88C	Chevrolet Suburban Chief LX CC, dimensions: 30.125L x 48W	\$4,545.00	\$3,892.44
336320	TruckVault Inc.	C-CHSUBN6-07C	Chevrolet Suburban Chief LX CC, dimensions: 30.125L x 48W	\$4,845.00	\$4,149.37
336320	TruckVault Inc.	C-CHSUBN6-07C-PT	Chevrolet Suburban Chief LX CC, dimensions: 30.125L x 48W	\$5,540.00	\$4,744.58
336320	TruckVault Inc.	C-CHSUBN6-07T	Chevrolet Suburban Tac Ctr, dimensions: 30.125L x 48W	\$4,845.00	\$4,149.37
336320	TruckVault Inc.	C-CHSUBN6-12C	Chevrolet Suburban Chief LX CC, dimensions: 30.125L x 48W	\$4,845.00	\$4,149.37
336320	TruckVault Inc.	C-CHSUBN6-12T	Chevrolet Suburban Tac Ctr, dimensions: 30.125L x 48W	\$4,845.00	\$4,149.37
336320	TruckVault Inc.	C-CHSUBN6-15C	Chevrolet Suburban Chief LX CC, dimensions: 30.125L x 48W	\$4,845.00	\$4,149.37
336320	TruckVault Inc.	C-CHSUBN6-15C-HT	Suburban Chief LX CC	\$5,540.00	\$4,744.58
336320	TruckVault Inc.	C-CHSUBN6-15C-PT	Chevrolet Suburban Chief LX CC, dimensions: 30.125L x 46W	\$5,540.00	\$4,744.58
336320	TruckVault Inc.	C-CHSUBN6-15N-HT-ZC10578A	Suburban CustomC10578A	\$5,235.00	\$4,483.38
336320	TruckVault Inc.	C-CHSUBN6-15N-ZC10578A	Suburban CustomC10578A	\$5,235.00	\$4,483.38
336320	TruckVault Inc.	C-CHSUBN6-15T	Chevrolet Suburban Tac Ctr, dimensions: 30.125L x 48W	\$4,845.00	\$4,149.37
336320	TruckVault Inc.	C-CHSUBN6-15T-PT	Chevrolet Suburban Tac Ctr, dimensions: 30.125L x 48W	\$5,540.00	\$4,744.58
336320	TruckVault Inc.	C-CHSUBN6-21C-TF-ZC11755	Suburban Chief LX CC	\$5,400.00	\$4,624.69
336320	TruckVault Inc.	C-CHSUBN6-21C-TF-ZC11755B	Suburban Chief LX CC	\$5,400.00	\$4,624.69
336320	TruckVault Inc.	C-CHSUBN6-21T-TF-ZC11345A	Suburban Tac Ctr	\$5,845.00	\$5,005.79
336320	TruckVault Inc.	C-CHSUBN6-88C	Chevrolet Suburban Chief LX CC, dimensions: 30.125L x 48W	\$4,845.00	\$4,149.37
336320	TruckVault Inc.	C-CHSUBN6-88T	Chevrolet Suburban Tac Ctr, dimensions: 30.125L x 48W	\$4,845.00	\$4,149.37
336320	TruckVault Inc.	C-CHSUBN7-00O	Chevrolet Suburban CUST Office Ctr, dimensions: 0L x 0W	\$6,905.00	\$5,913.60
336320	TruckVault Inc.	C-CHSUBN7-07E	Chevrolet Suburban Op Ctr, dimensions: 58L x 48W	\$6,905.00	\$5,913.60
336320	TruckVault Inc.	C-CHSUBN7-12E	Chevrolet Suburban Op Ctr, dimensions: 58L x 48W	\$6,905.00	\$5,913.60
336320	TruckVault Inc.	C-CHSUBN7-88E	Chevrolet Suburban Full-Length Op Ctr, dimensions: 60L x 48W	\$6,905.00	\$5,913.60
336320	TruckVault Inc.	C-CHSUBN9-00O	Chevrolet Suburban Office Ctr, dimensions: 54L x 48W	\$8,285.00	\$7,095.47
336320	TruckVault Inc.	C-CHSUBN9-07O	Chevrolet Suburban Office Ctr, dimensions: 54L x 48W	\$8,285.00	\$7,095.47
336320	TruckVault Inc.	C-CHSUBN9-12O	Chevrolet Suburban Office Ctr, dimensions: 54L x 48W	\$8,285.00	\$7,095.47
336320	TruckVault Inc.	C-CHSUBS1-00F-C6-ZC8661	Suburban Cust Surveyor	\$3,505.00	\$3,001.76
336320	TruckVault Inc.	C-CHSUBS2-07F-PP-VF	Suburban Surveyor	\$2,605.00	\$2,230.98
336320	TruckVault Inc.	C-CHSUBS2-07F-VF	Suburban Surveyor	\$2,605.00	\$2,230.98
336320	TruckVault Inc.	C-CHTAHM1-15N-C4-ZC8364	Tahoe CUST	\$3,495.00	\$2,993.20

336320	TruckVault Inc.	C-CHTAHM1-15N-ZC9636	Tahoe Mag 1 Dwr w/Map Board Drawer	\$3,065.00	\$2,624.94
336320	TruckVault Inc.	C-CHTAHM2-15N-C1-ZC10979	Tahoe Mag 2 Dwr With CubbyTray/3rd Removed	\$3,235.00	\$2,770.53
336320	TruckVault Inc.	C-CHTAHM2-15N-C2-ZC8369	Tahoe Mag 2 Dwr	\$4,015.00	\$3,438.54
336320	TruckVault Inc.	C-CHTAHM2-15N-PP-ZC7696	Tahoe CUST Stack	\$3,615.00	\$3,095.97
336320	TruckVault Inc.	C-CHTAHM2-15N-ZC10418	Tahoe Stacked 2 DwrMagnum	\$2,885.00	\$2,470.78
336320	TruckVault Inc.	C-CHTAHM2-15N-ZC9640	Tahoe CUST CC	\$4,265.00	\$3,652.64
336320	TruckVault Inc.	C-CHTAHM3-15N-C1-ZC8534	Tahoe 3 Drawer	\$3,865.00	\$3,310.08
336320	TruckVault Inc.	C-CHTAHM3-15N-PP-ZC8271	Tahoe CUST	\$3,605.00	\$3,087.41
336320	TruckVault Inc.	C-CHTAHM3-15N-ZC7640	Tahoe CUST 3 Drawer	\$2,975.00	\$2,547.86
336320	TruckVault Inc.	C-CHTAHN0-12N-C7-ZC10490	Tahoe CustomC10490	\$1,295.00	\$1,109.07
336320	TruckVault Inc.	C-CHTAHN0-15N-C2-ZC10235	Tahoe Open Cubbies with Power TrayTray/3rd Removed	\$2,455.00	\$2,102.52
336320	TruckVault Inc.	C-CHTAHN0-15N-C10-ZC8803	Tahoe Custom	\$2,255.00	\$1,931.23
336320	TruckVault Inc.	C-CHTAHN0-15N-C2-HT-TT-ZC9212	Tahoe Custom	\$2,485.00	\$2,128.21
336320	TruckVault Inc.	C-CHTAHN0-15N-C2-ZC10723	Tahoe CustomC10723	\$1,325.00	\$1,134.76
336320	TruckVault Inc.	C-CHTAHN0-15N-C2-ZC7947	Tahoe CUST	\$1,345.00	\$1,151.89
336320	TruckVault Inc.	C-CHTAHN0-15N-C2-ZC8391	Tahoe Custom	\$1,895.00	\$1,622.92
336320	TruckVault Inc.	C-CHTAHN0-15N-C2-ZC8412	Tahoe Custom	\$1,015.00	\$869.27
336320	TruckVault Inc.	C-CHTAHN0-15N-C3-TT-ZC8603	Tahoe Custom	\$2,335.00	\$1,999.75
336320	TruckVault Inc.	C-CHTAHN0-15N-C3-TT-ZC8652	Tahoe Custom	\$2,335.00	\$1,999.75
336320	TruckVault Inc.	C-CHTAHN0-15N-C3-ZC8652	Tahoe Custom Cubby Unit	\$2,035.00	\$1,742.82
336320	TruckVault Inc.	C-CHTAHN0-15N-C4-ZC10894	Tahoe CustomC10894	\$1,765.00	\$1,511.59
336320	TruckVault Inc.	C-CHTAHN0-15N-C5-ZC10833	Tahoe CustomC10833	\$1,535.00	\$1,314.61
336320	TruckVault Inc.	C-CHTAHN1-15N-C12-ZC10502	Tahoe CustomC10502	\$5,525.00	\$4,731.74
336320	TruckVault Inc.	C-CHTAHN1-15N-C1-TT-ZC9314	Tahoe Custom	\$3,065.00	\$2,624.94
336320	TruckVault Inc.	C-CHTAHN1-15N-C1-ZC11382A	Tahoe Custom	\$3,475.00	\$2,976.07
336320	TruckVault Inc.	C-CHTAHN1-15N-C3-ZC8279	Tahoe CUST CC	\$2,125.00	\$1,819.90
336320	TruckVault Inc.	C-CHTAHN1-15N-C3-ZC8884	Tahoe Custom	\$3,155.00	\$2,702.02
336320	TruckVault Inc.	C-CHTAHN1-15N-C3-ZC9027	Tahoe Custom	\$2,045.00	\$1,751.39
336320	TruckVault Inc.	C-CHTAHN1-15N-C3-ZC9343	Map board-power box -cubbies	\$2,935.00	\$2,513.60
336320	TruckVault Inc.	C-CHTAHN1-15N-C3-ZC9432	Tahoe Custom	\$2,045.00	\$1,751.39
336320	TruckVault Inc.	C-CHTAHN1-15N-C3-ZC9918	Tahoe Custom	\$2,365.00	\$2,025.44
336320	TruckVault Inc.	C-CHTAHN1-15N-C4-ZC10016	Tahoe CustomC10016	\$2,925.00	\$2,505.04
336320	TruckVault Inc.	C-CHTAHN1-15N-C4-ZC10782D	Tahoe CustomD10782D	\$3,795.00	\$3,250.13
336320	TruckVault Inc.	C-CHTAHN1-15N-C4-ZC10782F	Tahoe CustomC10782F	\$4,505.00	\$3,858.19
336320	TruckVault Inc.	C-CHTAHN1-15N-C4-ZC10821A	Tahoe CustomC10821A	\$4,505.00	\$3,858.19
336320	TruckVault Inc.	C-CHTAHN1-15N-C4-ZC8595	Tahoe Custom	\$3,515.00	\$3,010.33
336320	TruckVault Inc.	C-CHTAHN1-15N-C5-HT-ZC10435	Tahoe CustomC10435	\$5,045.00	\$4,320.65
336320	TruckVault Inc.	C-CHTAHN1-15N-C6-ZC8977	Tahoe Custom	\$3,735.00	\$3,198.74
336320	TruckVault Inc.	C-CHTAHN1-15N-C8-ZC8385	Tahoe Custom Command Center	\$3,725.00	\$3,190.18
336320	TruckVault Inc.	C-CHTAHN1-15N-HT-C1-ZC10321	Tahoe Custom	\$4,515.00	\$3,866.75
336320	TruckVault Inc.	C-CHTAHN1-15N-HT-C2-ZC10230	Tahoe CustomC10230	\$3,095.00	\$2,650.63
336320	TruckVault Inc.	C-CHTAHN1-15N-HT-ZC10674A	Tahoe Custom 1 DwrTray/3rd Removed; HD Table	\$3,475.00	\$2,976.07
336320	TruckVault Inc.	C-CHTAHN1-15N-ZC9440	Tahoe Custom	\$2,665.00	\$2,282.37
336320	TruckVault Inc.	C-CHTAHN2-07I	Tahoe Investigator 2 Dwr	\$3,325.00	\$2,847.61
336320	TruckVault Inc.	C-CHTAHN2-07N-C1-ZC11230A	Tahoe CustomC11230A	\$4,005.00	\$3,429.97
336320	TruckVault Inc.	C-CHTAHN2-12I	Tahoe Investigator 2 Dwr	\$3,325.00	\$2,847.61
336320	TruckVault Inc.	C-CHTAHN2-12I-PP	Tahoe Investigator 2 Dwr	\$3,225.00	\$2,761.96
336320	TruckVault Inc.	C-CHTAHN2-12N-C1-TT-ZC8995	Tahoe Custom	\$3,405.00	\$2,916.12
336320	TruckVault Inc.	C-CHTAHN2-12N-Y1	Tahoe CUST	\$3,125.00	\$2,676.32
336320	TruckVault Inc.	C-CHTAHN2-12N-Y4	Tahoe CUSTC4827	\$3,595.00	\$3,078.84
336320	TruckVault Inc.	C-CHTAHN2-12N-Y5	Tahoe CUSTC5900	\$3,055.00	\$2,616.37
336320	TruckVault Inc.	C-CHTAHN2-15D	Tahoe Special Ops Ctr	\$3,325.00	\$2,847.61
336320	TruckVault Inc.	C-CHTAHN2-15I	Tahoe Investigator 2 Dwr	\$3,325.00	\$2,847.61
336320	TruckVault Inc.	C-CHTAHN2-15I-HT	Tahoe Investigator 2 Dwr	\$4,020.00	\$3,442.82
336320	TruckVault Inc.	C-CHTAHN2-15I-PP	Chevrolet Tahoe Investigator 2 Dwr, dimensions: 35L x 48W	\$3,225.00	\$2,761.96
336320	TruckVault Inc.	C-CHTAHN2-15N-C1-ZC10373	Tahoe CustomTray/3rd Removed	\$3,815.00	\$3,267.25
336320	TruckVault Inc.	C-CHTAHN2-15N-C1-ZC10432	Tahoe CustomC10432	\$2,275.00	\$1,948.36
336320	TruckVault Inc.	C-CHTAHN2-15N-C1-ZC10553	Tahoe CustomC10553	\$3,405.00	\$2,916.12
336320	TruckVault Inc.	C-CHTAHN2-15N-C1-ZC10748B	Tahoe CustomC10748B	\$3,425.00	\$2,933.25
336320	TruckVault Inc.	C-CHTAHN2-15N-C1-ZC9329	Tahoe Custom	\$3,885.00	\$3,327.20
336320	TruckVault Inc.	C-CHTAHN2-15N-C1-ZC9911	Tahoe CustomC9911	\$3,445.00	\$2,950.38
336320	TruckVault Inc.	C-CHTAHN2-15N-C2-ZC10148	Tahoe CustomC10148	\$3,565.00	\$3,053.15
336320	TruckVault Inc.	C-CHTAHN2-15N-C2-ZC10722	Tahoe CustomC10722	\$3,555.00	\$3,044.58
336320	TruckVault Inc.	C-CHTAHN2-15N-C2-ZC11045B	Tahoe CustomC11045B	\$3,115.00	\$2,667.76
336320	TruckVault Inc.	C-CHTAHN2-15N-C2-ZC8096	Tahoe CUST	\$2,635.00	\$2,256.68
336320	TruckVault Inc.	C-CHTAHN2-15N-C2-ZC8875	Tahoe Custom	\$4,415.00	\$3,781.11

336320	TruckVault Inc.	C-CHTAHN2-15N-C2-ZC8994	Tahoe Custom	\$3,385.00	\$2,898.99
336320	TruckVault Inc.	C-CHTAHN2-15N-C2-ZC9739	Tahoe CUSTC9739	\$3,115.00	\$2,667.76
336320	TruckVault Inc.	C-CHTAHN2-15N-C3-HT-ZC8399	Tahoe Custom	\$4,405.00	\$3,772.54
336320	TruckVault Inc.	C-CHTAHN2-15N-C3-TT-ZC9268	Tahoe 2 Dwr Stacked	\$4,055.00	\$3,472.80
336320	TruckVault Inc.	C-CHTAHN2-15N-C3-ZC10542	Tahoe CustomC10542	\$3,565.00	\$3,053.15
336320	TruckVault Inc.	C-CHTAHN2-15N-C3-ZC10629A	Tahoe CustomerC10629A	\$3,455.00	\$2,958.94
336320	TruckVault Inc.	C-CHTAHN2-15N-C3-ZC10820	Tahoe CUSTC10820	\$4,505.00	\$3,858.19
336320	TruckVault Inc.	C-CHTAHN2-15N-C3-ZC8472	Tahoe CUST	\$3,905.00	\$3,344.33
336320	TruckVault Inc.	C-CHTAHN2-15N-C3-ZC9517	Tahoe Customer	\$3,385.00	\$2,898.99
336320	TruckVault Inc.	C-CHTAHN2-15N-C4-ZC8397	Tahoe CUST	\$3,385.00	\$2,898.99
336320	TruckVault Inc.	C-CHTAHN2-15N-C4-ZC8486	Tahoe CUST	\$4,575.00	\$3,918.14
336320	TruckVault Inc.	C-CHTAHN2-15N-C5-ZC10812A	Tahoe CustomC10812A	\$5,145.00	\$4,406.30
336320	TruckVault Inc.	C-CHTAHN2-15N-C5-ZC8292	Tahoe CUST	\$3,725.00	\$3,190.18
336320	TruckVault Inc.	C-CHTAHN2-15N-C5-ZC8598	Tahoe CUST	\$3,485.00	\$2,984.63
336320	TruckVault Inc.	C-CHTAHN2-15N-C6-ZC11278A	TahoeTray/3rd Removed	\$4,825.00	\$4,132.24
336320	TruckVault Inc.	C-CHTAHN2-15N-C6-ZC9082	Tahoe Custom	\$4,645.00	\$3,978.09
336320	TruckVault Inc.	C-CHTAHN2-15N-C6-ZC9689	Tahoe CUST	\$5,585.00	\$4,783.12
336320	TruckVault Inc.	C-CHTAHN2-15N-C6-ZC9690	Tahoe Custom	\$5,585.00	\$4,783.12
336320	TruckVault Inc.	C-CHTAHN2-15N-C9-ZC8544	Tahoe CUST	\$6,615.00	\$5,665.24
336320	TruckVault Inc.	C-CHTAHN2-15N-HP-ZC11310	Tahoe Custom	\$3,055.00	\$2,616.37
336320	TruckVault Inc.	C-CHTAHN2-15N-HT-C1-ZC10239	Tahoe CustomC10239	\$4,895.00	\$4,192.19
336320	TruckVault Inc.	C-CHTAHN2-15N-HT-C1-ZC9008	Tahoe Custom	\$4,275.00	\$3,661.21
336320	TruckVault Inc.	C-CHTAHN2-15N-HT-C1-ZC9196	Tahoe Custom	\$3,955.00	\$3,387.15
336320	TruckVault Inc.	C-CHTAHN2-15N-HT-C1-ZC9392	Tahoe CustomC9392	\$4,365.00	\$3,738.29
336320	TruckVault Inc.	C-CHTAHN2-15N-HT-C2-ZC11316	Tahoe Custom	\$5,155.00	\$4,414.86
336320	TruckVault Inc.	C-CHTAHN2-15N-PP-C1-ZC10033	Tahoe Custom	\$3,615.00	\$3,095.97
336320	TruckVault Inc.	C-CHTAHN2-15N-PP-C3-ZC8252	Tahoe Custom	\$3,615.00	\$3,095.97
336320	TruckVault Inc.	C-CHTAHN2-15N-PP-C4-ZC8575	Tahoe Custom	\$3,655.00	\$3,130.23
336320	TruckVault Inc.	C-CHTAHN2-15N-PP-HT-ZC11032	Tahoe CustomC11032	\$4,115.00	\$3,524.18
336320	TruckVault Inc.	C-CHTAHN2-15N-PP-HT-ZC9470	Tahoe Custom	\$4,055.00	\$3,472.80
336320	TruckVault Inc.	C-CHTAHN2-15N-PP-ZC10032	Tahoe Custom	\$2,445.00	\$2,093.95
336320	TruckVault Inc.	C-CHTAHN2-15N-PP-ZC10185	Tahoe CustomC10185	\$4,205.00	\$3,601.26
336320	TruckVault Inc.	C-CHTAHN2-15N-PP-ZC11221	Tahoe 2 Dwr Cage Present1 Dwr Bot, 1/2 Drawer Top	\$3,225.00	\$2,761.96
336320	TruckVault Inc.	C-CHTAHN2-15N-PP-ZC6954	Tahoe Custom	\$2,445.00	\$2,093.95
336320	TruckVault Inc.	C-CHTAHN2-15N-PP-ZC8197	Tahoe Custom	\$2,995.00	\$2,564.99
336320	TruckVault Inc.	C-CHTAHN2-15N-PP-ZC9939	Tahoe Custom	\$3,335.00	\$2,856.17
336320	TruckVault Inc.	C-CHTAHN2-15N-ZC10372	Tahoe CustomC10372	\$3,565.00	\$3,053.15
336320	TruckVault Inc.	C-CHTAHN2-15N-ZC10750	Tahoe CustomC10750	\$3,575.00	\$3,061.71
336320	TruckVault Inc.	C-CHTAHN2-15N-ZC10924D	Tahoe CustomC10924D	\$3,335.00	\$2,856.17
336320	TruckVault Inc.	C-CHTAHN2-15N-ZC11589	Tahoe Custom	\$3,265.00	\$2,796.22
336320	TruckVault Inc.	C-CHTAHN2-15N-ZC8586	Tahoe Custom	\$3,265.00	\$2,796.22
336320	TruckVault Inc.	C-CHTAHN2-15N-ZC9436	Tahoe Custom	\$3,055.00	\$2,616.37
336320	TruckVault Inc.	C-CHTAHN2-15N-ZC9487	Tahoe Custom	\$3,045.00	\$2,607.81
336320	TruckVault Inc.	C-CHTAHN2-15N-ZC9514	Tahoe Custom	\$3,725.00	\$3,190.18
336320	TruckVault Inc.	C-CHTAHN2-15N-ZC9939	Tahoe 2 Dwr, Stacked	\$3,335.00	\$2,856.17
336320	TruckVault Inc.	C-CHTAHN2-15-ZC10854A	Tahoe 2 Dwr Stacked	\$3,275.00	\$2,804.79
336320	TruckVault Inc.	C-CHTAHN2-21I-TF	Tahoe Investigator 2 Dwr	\$3,325.00	\$2,847.61
336320	TruckVault Inc.	C-CHTAHN2-21I-TR-PP	Tahoe Investigator 2 Dwr	\$3,325.00	\$2,847.61
336320	TruckVault Inc.	C-CHTAHN2-21N-TF-C3-HT-C11250C	Tahoe CustomC11250C	\$3,820.00	\$3,271.54
336320	TruckVault Inc.	C-CHTAHN2-21N-TR-C2-ZC11254	Tahoe 2 Dwr Stacked	\$3,135.00	\$2,684.89
336320	TruckVault Inc.	C-CHTAHN2-21N-TR-PP-ZC11622	Tahoe Custom 3rd Seat Removed	\$2,445.00	\$2,093.95
336320	TruckVault Inc.	C-CHTAHN2-21N-TR-ZC11541	Tahoe Custom	\$3,215.00	\$2,753.40
336320	TruckVault Inc.	C-CHTAHN3-00D	Chevrolet Tahoe Special Ops Ctr, dimensions: 45L x 48W	\$3,825.00	\$3,275.82
336320	TruckVault Inc.	C-CHTAHN3-00D-PT	Chevrolet Tahoe Special Ops Ctr, dimensions: 45L x 48W	\$4,520.00	\$3,871.03
336320	TruckVault Inc.	C-CHTAHN3-00I	Chevrolet Tahoe Investigator, dimensions: 43L x 48W	\$3,825.00	\$3,275.82
336320	TruckVault Inc.	C-CHTAHN3-00N-HT-ZC11608B	Tahoe Custom	\$4,825.00	\$4,132.24
336320	TruckVault Inc.	C-CHTAHN3-00R	Chevrolet Tahoe Field Ranger, dimensions: 43L x 48W	\$3,245.00	\$2,779.09
336320	TruckVault Inc.	C-CHTAHN3-00R-HT	Tahoe Field Ranger	\$3,940.00	\$3,374.31
336320	TruckVault Inc.	C-CHTAHN3-00R-PP	Chevrolet Tahoe Field Ranger, dimensions: 40L x 48W	\$3,245.00	\$2,779.09
336320	TruckVault Inc.	C-CHTAHN3-07D	Chevrolet Tahoe Special Ops Ctr, dimensions: 39L x 48W	\$3,825.00	\$3,275.82
336320	TruckVault Inc.	C-CHTAHN3-07D-HT	Tahoe Special Ops Ctr	\$4,520.00	\$3,871.03
336320	TruckVault Inc.	C-CHTAHN3-07D-PP	Chevrolet Tahoe Special Ops Ctr, dimensions: 36L x 48W	\$3,825.00	\$3,275.82
336320	TruckVault Inc.	C-CHTAHN3-07D-PT	Chevrolet Tahoe Special Ops Ctr, dimensions: 37L x 48W	\$4,520.00	\$3,871.03
336320	TruckVault Inc.	C-CHTAHN3-07I	Chevrolet Tahoe Investigator, dimensions: 38L x 48W	\$3,825.00	\$3,275.82
336320	TruckVault Inc.	C-CHTAHN3-07I-PP	Chevrolet Tahoe Investigator, dimensions: 35L x 48W	\$3,725.00	\$3,190.18
336320	TruckVault Inc.	C-CHTAHN3-07I-PP-PT	Chevrolet Tahoe Investigator, dimensions: 35L x 48W	\$4,420.00	\$3,785.39



336320	TruckVault Inc.	C-CHTAHN3-07I-PT	Chevrolet Tahoe Investigator, dimensions: 38L x 48W	\$4,520.00	\$3,871.03
336320	TruckVault Inc.	C-CHTAHN3-07N-HT-C1-ZC9157	Tahoe Custom	\$6,275.00	\$5,374.06
336320	TruckVault Inc.	C-CHTAHN3-07N-HT-ZC8546	Tahoe CUST	\$3,605.00	\$3,087.41
336320	TruckVault Inc.	C-CHTAHN3-07N-ZC8384	Tahoe CUST	\$6,805.00	\$5,827.96
336320	TruckVault Inc.	C-CHTAHN3-07R	Chevrolet Tahoe Field Ranger, dimensions: 38L x 48W	\$3,245.00	\$2,779.09
336320	TruckVault Inc.	C-CHTAHN3-07R-PP	Chevrolet Tahoe Field Ranger, dimensions: 35L x 48W	\$3,045.00	\$2,607.81
336320	TruckVault Inc.	C-CHTAHN3-07R-PP-PT	Chevrolet Tahoe Field Ranger, dimensions: 37L x 49W	\$3,940.00	\$3,374.31
336320	TruckVault Inc.	C-CHTAHN3-07R-PT	Chevrolet Tahoe Field Ranger, dimensions: 37L x 48W	\$3,940.00	\$3,374.31
336320	TruckVault Inc.	C-CHTAHN3-12D	Chevrolet Tahoe Special Ops Ctr, dimensions: 39L x 48W	\$3,825.00	\$3,275.82
336320	TruckVault Inc.	C-CHTAHN3-12D-PP	Chevrolet Tahoe Special Ops Ctr, dimensions: 36L x 48W	\$3,825.00	\$3,275.82
336320	TruckVault Inc.	C-CHTAHN3-12D-PT	Chevrolet Tahoe Special Ops Ctr, dimensions: 37L x 48W	\$4,520.00	\$3,871.03
336320	TruckVault Inc.	C-CHTAHN3-12I	Chevrolet Tahoe Investigator, dimensions: 38L x 48W	\$3,825.00	\$3,275.82
336320	TruckVault Inc.	C-CHTAHN3-12I-PP	Chevrolet Tahoe Investigator, dimensions: 35L x 48W	\$3,725.00	\$3,190.18
336320	TruckVault Inc.	C-CHTAHN3-12I-PP-PT	Chevrolet Tahoe Investigator, dimensions: 35L x 48W	\$4,420.00	\$3,785.39
336320	TruckVault Inc.	C-CHTAHN3-12I-PT	Chevrolet Tahoe Investigator, dimensions: 38L x 48W	\$4,520.00	\$3,871.03
336320	TruckVault Inc.	C-CHTAHN3-12R	Chevrolet Tahoe Field Ranger, dimensions: 38L x 48W	\$3,245.00	\$2,779.09
336320	TruckVault Inc.	C-CHTAHN3-12R-PP	Chevrolet Tahoe Field Ranger, dimensions: 35L x 48W	\$3,045.00	\$2,607.81
336320	TruckVault Inc.	C-CHTAHN3-12R-PP-PT	Chevrolet Tahoe Field Ranger, dimensions: 37L x 49W	\$3,940.00	\$3,374.31
336320	TruckVault Inc.	C-CHTAHN3-15D	Chevrolet Tahoe Special Ops Ctr, dimensions: 39L x 48W	\$3,825.00	\$3,275.82
336320	TruckVault Inc.	C-CHTAHN3-15D-C1-ZC11210A	Tahoe Special Ops Ctr With Back CubbyTray/3rd Removed	\$3,375.00	\$2,890.43
336320	TruckVault Inc.	C-CHTAHN3-15D-HT	Chevrolet Tahoe Special Ops Ctr, dimensions: 38L x 48W	\$4,520.00	\$3,871.03
336320	TruckVault Inc.	C-CHTAHN3-15D-HT-BS	Tahoe Special Ops Ctr	\$4,520.00	\$3,871.03
336320	TruckVault Inc.	C-CHTAHN3-15D-PP	Chevrolet Tahoe Special Ops Ctr, dimensions: 36L x 48W	\$3,825.00	\$3,275.82
336320	TruckVault Inc.	C-CHTAHN3-15D-PP-HT	Tahoe Special Ops Ctr	\$4,420.00	\$3,785.39
336320	TruckVault Inc.	C-CHTAHN3-15D-PP-PT	Chevrolet Tahoe Special Ops Ctr, dimensions: 37L x 48W	\$4,520.00	\$3,871.03
336320	TruckVault Inc.	C-CHTAHN3-15D-PT	Chevrolet Tahoe Special Ops Ctr, dimensions: 37L x 48W	\$4,520.00	\$3,871.03
336320	TruckVault Inc.	C-CHTAHN3-15I	Chevrolet Tahoe Investigator, dimensions: 38L x 48W	\$3,825.00	\$3,275.82
336320	TruckVault Inc.	C-CHTAHN3-15I-HT	Chevrolet Tahoe Investigator, dimensions: 37L x 48W	\$4,520.00	\$3,871.03
336320	TruckVault Inc.	C-CHTAHN3-15I-PP	Chevrolet Tahoe Investigator, dimensions: 35L x 48W	\$3,725.00	\$3,190.18
336320	TruckVault Inc.	C-CHTAHN3-15I-PP-HT	Tahoe Investigator	\$4,420.00	\$3,785.39
336320	TruckVault Inc.	C-CHTAHN3-15I-PP-PT	Chevrolet Tahoe Investigator, dimensions: 35L x 0W	\$4,420.00	\$3,785.39
336320	TruckVault Inc.	C-CHTAHN3-15I-PT	Chevrolet Tahoe Investigator, dimensions: 38L x 48W	\$4,520.00	\$3,871.03
336320	TruckVault Inc.	C-CHTAHN3-15I-ZC10059	Tahoe CustomC10059	\$3,445.00	\$2,950.38
336320	TruckVault Inc.	C-CHTAHN3-15N-C1-15N-ZC9065	Tahoe Custom	\$3,765.00	\$3,224.43
336320	TruckVault Inc.	C-CHTAHN3-15N-C1-HT-ZC11058A	Tahoe CustomC11058A	\$5,945.00	\$5,091.44
336320	TruckVault Inc.	C-CHTAHN3-15N-C1-HT-ZC11058C	Tahoe CustomC11058C	\$5,945.00	\$5,091.44
336320	TruckVault Inc.	C-CHTAHN3-15N-C1-HT-ZC9083	3 drawer, open cubby w/tray & Map	\$5,005.00	\$4,286.40
336320	TruckVault Inc.	C-CHTAHN3-15N-C1-ZC7705	Tahoe Custom	\$4,465.00	\$3,823.93
336320	TruckVault Inc.	C-CHTAHN3-15N-C1-ZC8287	Tahoe Custom	\$3,335.00	\$2,856.17
336320	TruckVault Inc.	C-CHTAHN3-15N-C1-ZC8320	Tahoe Custom	\$3,045.00	\$2,607.81
336320	TruckVault Inc.	C-CHTAHN3-15N-C1-ZC9472	Tahoe With Radio Box &bpullout tray	\$3,545.00	\$3,036.02
336320	TruckVault Inc.	C-CHTAHN3-15N-C1-ZC9855	Tahoe Custom	\$2,905.00	\$2,487.91
336320	TruckVault Inc.	C-CHTAHN3-15N-C2-ZC10375	Tahoe CustomC10375	\$3,925.00	\$3,361.46
336320	TruckVault Inc.	C-CHTAHN3-15N-C2-ZC10835	Tahoe CustomC10835	\$3,995.00	\$3,421.41
336320	TruckVault Inc.	C-CHTAHN3-15N-C2-ZC10846	Tahoe CustomC10846	\$4,015.00	\$3,438.54
336320	TruckVault Inc.	C-CHTAHN3-15N-C2-ZC11267	Tahoe Custom	\$3,135.00	\$2,684.89
336320	TruckVault Inc.	C-CHTAHN3-15N-C2-ZC9947	Tahoe Custom Cubbies, File Drawers	\$2,795.00	\$2,393.70
336320	TruckVault Inc.	C-CHTAHN3-15N-C3-ZC10840	Tahoe CustomC10840	\$3,035.00	\$2,599.24
336320	TruckVault Inc.	C-CHTAHN3-15N-C3-ZC9197	Tahoe Custom	\$4,555.00	\$3,901.01
336320	TruckVault Inc.	C-CHTAHN3-15N-C4-ZC8003	Tahoe CUST	\$5,375.00	\$4,603.27
336320	TruckVault Inc.	C-CHTAHN3-15N-C4-ZC8396	Tahoe CUST	\$4,725.00	\$4,046.60
336320	TruckVault Inc.	C-CHTAHN3-15N-C4-ZC9087	Tahoe Custom	\$4,525.00	\$3,875.31
336320	TruckVault Inc.	C-CHTAHN3-15N-C4-ZC9526	Tahoe Custom	\$4,485.00	\$3,841.06
336320	TruckVault Inc.	C-CHTAHN3-15N-C7-ZC10342	Tahoe CustomC10342	\$4,525.00	\$3,875.31
336320	TruckVault Inc.	C-CHTAHN3-15N-HT-C1-ZC10665	Tahoe CustomC10665	\$4,555.00	\$3,901.01
336320	TruckVault Inc.	C-CHTAHN3-15N-HT-C1-ZC9566	Tahoe Custom	\$5,865.00	\$5,022.92
336320	TruckVault Inc.	C-CHTAHN3-15N-HT-C5-ZC10875B	Tahoe CustomC10875B	\$4,925.00	\$4,217.88
336320	TruckVault Inc.	C-CHTAHN3-15N-HT-ZC10377	Tahoe CustomC10377	\$5,655.00	\$4,843.07
336320	TruckVault Inc.	C-CHTAHN3-15N-HT-ZC9176	Tahoe Custom	\$4,575.00	\$3,918.14
336320	TruckVault Inc.	C-CHTAHN3-15N-HT-ZC9263	Tahoe Custom	\$4,125.00	\$3,532.75
336320	TruckVault Inc.	C-CHTAHN3-15N-HT-ZC9372	Tahoe Custom	\$4,575.00	\$3,918.14
336320	TruckVault Inc.	C-CHTAHN3-15N-HT-ZC9389	Tahoe Custom	\$4,975.00	\$4,260.71
336320	TruckVault Inc.	C-CHTAHN3-15N-HT-ZC9586	Tahoe Custom	\$4,015.00	\$3,438.54
336320	TruckVault Inc.	C-CHTAHN3-15N-PP-C1-ZC8988	Tahoe Custom	\$2,905.00	\$2,487.91
336320	TruckVault Inc.	C-CHTAHN3-15N-PP-C1-ZC9379	Tahoe Custom	\$3,395.00	\$2,907.56
336320	TruckVault Inc.	C-CHTAHN3-15N-PP-HT-ZC9638	Tahoe Custom	\$4,495.00	\$3,849.62

336320	TruckVault Inc.	C-CHTAHN3-15N-PP-PT-C1-ZC9864	Tahoe 3 Drawer	\$4,895.00	\$4,192.19
336320	TruckVault Inc.	C-CHTAHN3-15N-PP-ZC10458	Tahoe Custom CommandC10458	\$3,655.00	\$3,130.23
336320	TruckVault Inc.	C-CHTAHN3-15N-PP-ZC11006	Tahoe CustomP-Cage; C11006	\$3,795.00	\$3,250.13
336320	TruckVault Inc.	C-CHTAHN3-15N-PP-ZC8628	Tahoe CUST 3 Dwr	\$3,975.00	\$3,404.28
336320	TruckVault Inc.	C-CHTAHN3-15N-PP-ZC9333	Tahoe Custom	\$3,305.00	\$2,830.48
336320	TruckVault Inc.	C-CHTAHN3-15N-PP-ZC9378	Tahoe Stacked w/map board	\$4,445.00	\$3,806.80
336320	TruckVault Inc.	C-CHTAHN3-15N-PT-ZC8205	Tahoe CUST CC	\$6,635.00	\$5,682.37
336320	TruckVault Inc.	C-CHTAHN3-15N-PT-ZC8220	Tahoe CUST CC	\$4,225.00	\$3,618.39
336320	TruckVault Inc.	C-CHTAHN3-15N-TT-ZC8354	Tahoe 3 Drawer	\$4,395.00	\$3,763.98
336320	TruckVault Inc.	C-CHTAHN3-15N-ZC10236	Tahoe CustomC10236	\$3,275.00	\$2,804.79
336320	TruckVault Inc.	C-CHTAHN3-15N-ZC10268	Tahoe CustomC10268	\$3,895.00	\$3,335.77
336320	TruckVault Inc.	C-CHTAHN3-15N-ZC10277	Tahoe 3drawer stackC10277	\$3,525.00	\$3,018.89
336320	TruckVault Inc.	C-CHTAHN3-15N-ZC10395	Tahoe Customwith Map Board Drawer	\$4,405.00	\$3,772.54
336320	TruckVault Inc.	C-CHTAHN3-15N-ZC10648	Tahoe 3 drawer stackedC10648	\$3,985.00	\$3,412.85
336320	TruckVault Inc.	C-CHTAHN3-15N-ZC10862B	Tahoe CustomC10862B	\$4,115.00	\$3,524.18
336320	TruckVault Inc.	C-CHTAHN3-15N-ZC11342	Tahoe Custom	\$3,795.00	\$3,250.13
336320	TruckVault Inc.	C-CHTAHN3-15N-ZC11781	Tahoe Custom 3 Drawer	\$3,630.00	\$3,108.82
336320	TruckVault Inc.	C-CHTAHN3-15N-ZC8592	Tahoe CUST	\$3,275.00	\$2,804.79
336320	TruckVault Inc.	C-CHTAHN3-15N-ZC8662	Tahoe CUST	\$3,605.00	\$3,087.41
336320	TruckVault Inc.	C-CHTAHN3-15N-ZC9418	Tahoe Custom	\$3,885.00	\$3,327.20
336320	TruckVault Inc.	C-CHTAHN3-15N-ZC9451	Tahoe CUST	\$2,655.00	\$2,273.80
336320	TruckVault Inc.	C-CHTAHN3-15N-ZC9498	Tahoe Custom	\$2,125.00	\$1,819.90
336320	TruckVault Inc.	C-CHTAHN3-15N-ZC9612	Tahoe Custom	\$3,965.00	\$3,395.72
336320	TruckVault Inc.	C-CHTAHN3-15N-ZC9875	Tahoe Custom	\$4,335.00	\$3,712.59
336320	TruckVault Inc.	C-CHTAHN3-15R	Chevrolet Tahoe Field Ranger, dimensions: 38L x 48W	\$3,245.00	\$2,779.09
336320	TruckVault Inc.	C-CHTAHN3-15R-CR	Tahoe Field Ranger	\$3,395.00	\$2,907.56
336320	TruckVault Inc.	C-CHTAHN3-15R-HT	Tahoe Field Ranger	\$3,940.00	\$3,374.31
336320	TruckVault Inc.	C-CHTAHN3-15R-PP	Chevrolet Tahoe Field Ranger, dimensions: 35L x 48W	\$3,045.00	\$2,607.81
336320	TruckVault Inc.	C-CHTAHN3-15R-PP-HT	Tahoe Field Ranger	\$3,740.00	\$3,203.02
336320	TruckVault Inc.	C-CHTAHN3-15R-PT	Chevrolet Tahoe Field Ranger, dimensions: 37L x 48W	\$3,940.00	\$3,374.31
336320	TruckVault Inc.	C-CHTAHN3-15R-TT	Tahoe Field Ranger	\$4,240.00	\$3,631.23
336320	TruckVault Inc.	C-CHTAHN3-21D-TR	Tahoe Special Ops Ctr3rd Removed	\$3,825.00	\$3,275.82
336320	TruckVault Inc.	C-CHTAHN3-21D-TR-HT	Tahoe Special Ops Ctr	\$4,520.00	\$3,871.03
336320	TruckVault Inc.	C-CHTAHN3-21D-TR-PP	Tahoe Special Ops Ctr3rd Removed, Cage	\$3,825.00	\$3,275.82
336320	TruckVault Inc.	C-CHTAHN3-21I-TF	Tahoe Investigator	\$3,825.00	\$3,275.82
336320	TruckVault Inc.	C-CHTAHN3-21I-TR	Tahoe Investigator3rd Removed	\$3,825.00	\$3,275.82
336320	TruckVault Inc.	C-CHTAHN3-21I-TR-PP	Tahoe Investigator3rd Removed, Cage	\$3,825.00	\$3,275.82
336320	TruckVault Inc.	C-CHTAHN3-21N-TR-HT-C2-ZC11246	Tahoe CustomShow Vault; C11246D	\$6,295.00	\$5,391.18
336320	TruckVault Inc.	C-CHTAHN3-21N-TR-PT-ZC11237	Tahoe 3 drawer stacked	\$4,175.00	\$3,575.57
336320	TruckVault Inc.	C-CHTAHN3-21N-TR-ZC11216	Tahoe 3 Drawer Stacked1 Drawer Bottom, 2 Drawer Top	\$4,845.00	\$4,149.37
336320	TruckVault Inc.	C-CHTAHN3-21N-TR-ZC11436	Tahoe Custom	\$3,565.00	\$3,053.15
336320	TruckVault Inc.	C-CHTAHN3-21R-TR	Tahoe Field Ranger3rd Removed	\$3,245.00	\$2,779.09
336320	TruckVault Inc.	C-CHTAHN3-21R-TR-PP	Tahoe Field Ranger	\$3,125.00	\$2,676.32
336320	TruckVault Inc.	C-CHTAHN3-92I	Chevrolet Tahoe Investigator, dimensions: 43L x 48W	\$3,825.00	\$3,275.82
336320	TruckVault Inc.	C-CHTAHN3-92R	Chevrolet Tahoe Field Ranger, dimensions: 42.5L x 48W	\$3,245.00	\$2,779.09
336320	TruckVault Inc.	C-CHTAHN3-96D	Chevrolet Tahoe Special Ops Ctr, dimensions: 0L x 0W	\$3,825.00	\$3,275.82
336320	TruckVault Inc.	C-CHTAHN3-96I	Chevrolet Tahoe Investigator, dimensions: 43L x 48W	\$3,825.00	\$3,275.82
336320	TruckVault Inc.	C-CHTAHN3-96I-PP	Chevrolet Tahoe Investigator, dimensions: 39L x 48W	\$3,825.00	\$3,275.82
336320	TruckVault Inc.	C-CHTAHN3-96R	Chevrolet Tahoe Field Ranger, dimensions: 42.5L x 48W	\$3,245.00	\$2,779.09
336320	TruckVault Inc.	C-CHTAHN4-07P	Chevrolet Tahoe Captain CC, dimensions: 30.125L x 48W	\$3,795.00	\$3,250.13
336320	TruckVault Inc.	C-CHTAHN4-12P	Chevrolet Tahoe Captain CC, dimensions: 30.125L x 48W	\$3,795.00	\$3,250.13
336320	TruckVault Inc.	C-CHTAHN4-15N-C1-HT-ZC10588A	Tahoe CustomC10588A	\$5,665.00	\$4,851.64
336320	TruckVault Inc.	C-CHTAHN4-15N-C1-ZC10124	Tahoe CustomC10124	\$4,135.00	\$3,541.31
336320	TruckVault Inc.	C-CHTAHN4-15N-C1-ZC8494	Tahoe Custom	\$3,635.00	\$3,113.10
336320	TruckVault Inc.	C-CHTAHN4-15N-C1-ZC8507	Tahoe Custom	\$4,455.00	\$3,815.37
336320	TruckVault Inc.	C-CHTAHN4-15N-C1-ZC8910	Tahoe Custom	\$3,605.00	\$3,087.41
336320	TruckVault Inc.	C-CHTAHN4-15N-C2-ZC8907	Tahoe Custom	\$3,615.00	\$3,095.97
336320	TruckVault Inc.	C-CHTAHN4-15N-C2-ZC9086	Tahoe Custom	\$4,705.00	\$4,029.47
336320	TruckVault Inc.	C-CHTAHN4-15N-C2-ZC9810	Tahoe Custom	\$4,855.00	\$4,157.93
336320	TruckVault Inc.	C-CHTAHN4-15N-C2-ZC9978	Tahoe Custom	\$5,845.00	\$5,005.79
336320	TruckVault Inc.	C-CHTAHN4-15N-C4-ZC8807	Tahoe Custom	\$4,805.00	\$4,115.11
336320	TruckVault Inc.	C-CHTAHN4-15N-C6-ZC10539	Tahoe CustomC10539	\$6,975.00	\$5,973.55
336320	TruckVault Inc.	C-CHTAHN4-15N-HT-C1-ZC10573	Tahoe CustomC10573	\$4,975.00	\$4,260.71
336320	TruckVault Inc.	C-CHTAHN4-15N-HT-ZC8718	Tahoe Custom	\$4,655.00	\$3,986.65
336320	TruckVault Inc.	C-CHTAHN4-15N-PP-HT-ZC9495	Tahoe Custom	\$5,125.00	\$4,389.17
336320	TruckVault Inc.	C-CHTAHN4-15N-TT-ZC9048	Tahoe Custom	\$3,395.00	\$2,907.56

336320	TruckVault Inc.	C-CHTAHN4-15N-ZC10179	Tahoe CustomC10179	\$3,935.00	\$3,370.03
336320	TruckVault Inc.	C-CHTAHN4-15N-ZC10361	Tahoe Custom	\$4,685.00	\$4,012.34
336320	TruckVault Inc.	C-CHTAHN4-15N-ZC10369	Tahoe CustomC10369	\$4,935.00	\$4,226.45
336320	TruckVault Inc.	C-CHTAHN4-15N-ZC8925	Tahoe Custom	\$3,385.00	\$2,898.99
336320	TruckVault Inc.	C-CHTAHN4-15N-ZC9172	Tahoe Custom	\$4,065.00	\$3,481.36
336320	TruckVault Inc.	C-CHTAHN4-15P	Chevrolet Tahoe Captain CC, dimensions: 30.125L x 48W	\$3,795.00	\$3,250.13
336320	TruckVault Inc.	C-CHTAHN4-21N-TR-ZC11328	Tahoe	\$4,235.00	\$3,626.95
336320	TruckVault Inc.	C-CHTAHN4-96P	Chevrolet Tahoe Captain CC, dimensions: 30.125L x 48W	\$3,795.00	\$3,250.13
336320	TruckVault Inc.	C-CHTAHN4-C1-21N-TR-HT-ZC11226	Tahoe Custom Command	\$5,325.00	\$4,560.45
336320	TruckVault Inc.	C-CHTAHN5-00P-PT	Chevrolet Tahoe Captain LX CC, dimensions: 30.125L x 48W	\$4,790.00	\$4,102.27
336320	TruckVault Inc.	C-CHTAHN5-00T	Tahoe Tac Ctr	\$4,545.00	\$3,892.44
336320	TruckVault Inc.	C-CHTAHN5-07C	Tahoe Chief LX CC	\$4,545.00	\$3,892.44
336320	TruckVault Inc.	C-CHTAHN5-07C-PP	Tahoe Chief LX CC	\$4,545.00	\$3,892.44
336320	TruckVault Inc.	C-CHTAHN5-07C-PT	Tahoe Chief LX CC	\$5,085.00	\$4,354.91
336320	TruckVault Inc.	C-CHTAHN5-07P	Chevrolet Tahoe Captain LX CC, dimensions: 30.125L x 48W	\$4,095.00	\$3,507.05
336320	TruckVault Inc.	C-CHTAHN5-07P-PT	Chevrolet Tahoe Captain LX CC, dimensions: 30.125L x 48W	\$4,790.00	\$4,102.27
336320	TruckVault Inc.	C-CHTAHN5-12C-PP	Tahoe Chief LX CC	\$4,545.00	\$3,892.44
336320	TruckVault Inc.	C-CHTAHN5-12C-PT	Tahoe Chief LX CC	\$5,240.00	\$4,487.66
336320	TruckVault Inc.	C-CHTAHN5-12P	Chevrolet Tahoe Captain LX CC, dimensions: 30.125L x 48W	\$4,095.00	\$3,507.05
336320	TruckVault Inc.	C-CHTAHN5-12P-PT	Chevrolet Tahoe Captain LX CC, dimensions: 30.125L x 48W	\$4,790.00	\$4,102.27
336320	TruckVault Inc.	C-CHTAHN5-15N-C1-HT-ZC10625A	Tahoe CustomC10625A	\$5,025.00	\$4,303.53
336320	TruckVault Inc.	C-CHTAHN5-15N-C1-ZC10370	Tahoe CustomC10370	\$4,365.00	\$3,738.29
336320	TruckVault Inc.	C-CHTAHN5-15N-C1-ZC10797	Tahoe CustomC10797	\$5,945.00	\$5,091.44
336320	TruckVault Inc.	C-CHTAHN5-15N-C1-ZC9863	Tahoe Custom	\$4,155.00	\$3,558.44
336320	TruckVault Inc.	C-CHTAHN5-15N-C2-ZC10842	Tahoe CustomC10842	\$5,385.00	\$4,611.84
336320	TruckVault Inc.	C-CHTAHN5-15N-C3-ZC8204	Tahoe CUST	\$5,485.00	\$4,697.48
336320	TruckVault Inc.	C-CHTAHN5-15N-HT-ZC10786	Tahoe CustomC10786	\$4,975.00	\$4,260.71
336320	TruckVault Inc.	C-CHTAHN5-15P	Chevrolet Tahoe Captain LX CC, dimensions: 30.125L x 48W	\$4,095.00	\$3,507.05
336320	TruckVault Inc.	C-CHTAHN5-15P-HT	Tahoe Captain LX CC	\$4,790.00	\$4,102.27
336320	TruckVault Inc.	C-CHTAHN5-15P-PP	Chevrolet Tahoe Captain LX CC, dimensions: 30.125L x 48W	\$4,095.00	\$3,507.05
336320	TruckVault Inc.	C-CHTAHN5-15P-PT	Chevrolet Tahoe Captain LX CC, dimensions: 30.125L x 48W	\$4,790.00	\$4,102.27
336320	TruckVault Inc.	C-CHTAHN5-15P-ZC8540	Tahoe Cust Length Captain LX CC	\$4,285.00	\$3,669.77
336320	TruckVault Inc.	C-CHTAHN5-15T	Chevrolet Tahoe Tac Ctr, dimensions: 30.125L x 48W	\$4,545.00	\$3,892.44
336320	TruckVault Inc.	C-CHTAHN5-15T-PT	Tahoe 5 Dwr Tac Ctr	\$5,240.00	\$4,487.66
336320	TruckVault Inc.	C-CHTAHN5-15T-ZC10746	Tahoe Tac Ctr	\$4,965.00	\$4,252.14
336320	TruckVault Inc.	C-CHTAHN5-21C-TR-HT	Tahoe Chief LX CC	\$5,240.00	\$4,487.66
336320	TruckVault Inc.	C-CHTAHN5-21N-TF-ZC11762	Tahoe Custom	\$4,300.00	\$3,682.62
336320	TruckVault Inc.	C-CHTAHN5-21P-TR	Tahoe Captain LX CC3rd Removed	\$4,095.00	\$3,507.05
336320	TruckVault Inc.	C-CHTAHN5-21P-TR-HT	Tahoe Captain LX CC	\$4,694.00	\$4,020.05
336320	TruckVault Inc.	C-CHTAHN5-95C	Chevrolet Tahoe Chief LX CC, dimensions: 30.125L x 48W	\$4,545.00	\$3,892.44
336320	TruckVault Inc.	C-CHTAHN5-95C-PT	Chevrolet Tahoe Chief LX CC, dimensions: 30.125L x 48W	\$5,240.00	\$4,487.66
336320	TruckVault Inc.	C-CHTAHN5-96P	Chevrolet Tahoe Captain LX CC, dimensions: 30.125L x 48W	\$4,095.00	\$3,507.05
336320	TruckVault Inc.	C-CHTAHN6-00T	Chevrolet Tahoe Tac Ctr, dimensions: 30.125L x 48W	\$4,845.00	\$4,149.37
336320	TruckVault Inc.	C-CHTAHN6-07C	Tahoe Chief LX CC	\$4,845.00	\$4,149.37
336320	TruckVault Inc.	C-CHTAHN6-07C-PP	Tahoe Chief LX CC	\$4,845.00	\$4,149.37
336320	TruckVault Inc.	C-CHTAHN6-07C-PT	Tahoe Chief LX CC	\$5,540.00	\$4,744.58
336320	TruckVault Inc.	C-CHTAHN6-07T	Chevrolet Tahoe Tac Ctr, dimensions: 30.125L x 48W	\$4,845.00	\$4,149.37
336320	TruckVault Inc.	C-CHTAHN6-07T-PT	Chevrolet Tahoe Tac Ctr, dimensions: 30.125L x 48W	\$5,540.00	\$4,744.58
336320	TruckVault Inc.	C-CHTAHN6-12C	Tahoe Chief LX CC	\$4,845.00	\$4,149.37
336320	TruckVault Inc.	C-CHTAHN6-12C-PP	Tahoe Chief LX CC	\$4,845.00	\$4,149.37
336320	TruckVault Inc.	C-CHTAHN6-12C-PT	Tahoe Chief LX CC	\$5,540.00	\$4,744.58
336320	TruckVault Inc.	C-CHTAHN6-12C-TR-PT	Tahoe Chief LX CCTable Extention 3rd Seat Removed	\$5,540.00	\$4,744.58
336320	TruckVault Inc.	C-CHTAHN6-12T	Chevrolet Tahoe Tac Ctr, dimensions: 30.125L x 48W	\$4,845.00	\$4,149.37
336320	TruckVault Inc.	C-CHTAHN6-15C	Chevrolet Tahoe Chief LX CC, dimensions: 30.125L x 46W	\$4,845.00	\$4,149.37
336320	TruckVault Inc.	C-CHTAHN6-15C-HT	Tahoe Chief LX CC	\$5,540.00	\$4,744.58
336320	TruckVault Inc.	C-CHTAHN6-15C-PT	Tahoe Chief LX CC	\$5,540.00	\$4,744.58
336320	TruckVault Inc.	C-CHTAHN6-15C-ZC10376	Tahoe 6 drawer StackTray/3rd Removed; C10376	\$6,525.00	\$5,588.16
336320	TruckVault Inc.	C-CHTAHN6-15C-ZC8146	Tahoe CUST Chief CC	\$5,125.00	\$4,389.17
336320	TruckVault Inc.	C-CHTAHN6-15C-ZC8150	Tahoe Chief LX Cust CC	\$4,975.00	\$4,260.71
336320	TruckVault Inc.	C-CHTAHN6-15N-ZC8028	Tahoe Custom	\$4,595.00	\$3,935.26
336320	TruckVault Inc.	C-CHTAHN6-15N-ZC8261	Tahoe CUST CC	\$4,065.00	\$3,481.36
336320	TruckVault Inc.	C-CHTAHN6-15T	Chevrolet Tahoe Tac Ctr, dimensions: 30.125L x 48W	\$4,845.00	\$4,149.37
336320	TruckVault Inc.	C-CHTAHN6-21C-TF-HT	Tahoe Chief LX CC3rd Folded; Heavy Duty Table	\$5,540.00	\$4,744.58
336320	TruckVault Inc.	C-CHTAHN6-21C-TR	Tahoe Chief LX CC3rd Removed	\$4,845.00	\$4,149.37
336320	TruckVault Inc.	C-CHTAHN6-21C-TR-HT	Tahoe Chief LX CC3rd Removed; HD Table	\$5,540.00	\$4,744.58
336320	TruckVault Inc.	C-CHTAHN6-21T-TF	Tahoe Tac Ctr	\$4,845.00	\$4,149.37

336320	TruckVault Inc.	C-CHTAHN6-21T-TR	Tahoe Tac Ctr	\$4,449.00	\$3,810.23
336320	TruckVault Inc.	C-CHTAHN6-95C	Chevrolet Tahoe Chief LX CC, dimensions: 30.125L x 48W	\$4,845.00	\$4,149.37
336320	TruckVault Inc.	C-CHTAHN6-95C-PT	Chevrolet Tahoe Chief LX CC, dimensions: 30.125L x 48W	\$5,540.00	\$4,744.58
336320	TruckVault Inc.	C-CHTAHS1-15N-PP-L1-ZC8240	Tahoe CUST	\$2,705.00	\$2,316.62
336320	TruckVault Inc.	C-CHTAHS2-15N-C1-ZC8010	Tahoe CUST	\$3,745.00	\$3,207.30
336320	TruckVault Inc.	C-CHTAHS2-15N-C2-ZC8201	Tahoe CUST	\$3,275.00	\$2,804.79
336320	TruckVault Inc.	C-CHTAHS2-15N-PP-ZC8045	Tahoe Std 2 Dwr Stacked	\$2,705.00	\$2,316.62
336320	TruckVault Inc.	C-CHTAHS2-15N-PP-ZC8225	Tahoe Std 2 Dwr Stacked	\$3,255.00	\$2,787.66
336320	TruckVault Inc.	C-CHTAHS2-21N-TF-C3-HT-C11523	Tahoe Custom, 3rd Folded, HD Table, Cubbies	\$3,820.00	\$3,271.54
336320	TruckVault Inc.	C-CHTAHS3-15N-ZC7931	Tahoe Std 3 Dwr Stacked	\$3,365.00	\$2,881.86
336320	TruckVault Inc.	C-CHTAHS3-15N-ZC7967	Tahoe Std 3 Dwr Stacked	\$3,365.00	\$2,881.86
336320	TruckVault Inc.	C-CHTAHSO-21N-TF-C3-HT-ZC11523	Tahoe Custom, 3rd Folded, HD Table, Cubbies	\$2,875.00	\$2,462.22
336320	TruckVault Inc.	C-CHTAHU5-15N-C1-ZC8667	Tahoe Cust 5 Dwr	\$4,205.00	\$3,601.26
336320	TruckVault Inc.	C-CHTBXN3-02I	Chevrolet Trailblazer Ext Investigator, dimensions: 32.5L x 44.5W	\$3,725.00	\$3,190.18
336320	TruckVault Inc.	C-CHTLBN3-02D	Chevrolet Trailblazer Special Ops Center, dimensions: 34L x 44.5W	\$3,725.00	\$3,190.18
336320	TruckVault Inc.	C-CHTLBN3-02I	Chevrolet Trailblazer Investigator, dimensions: 32.5L x 44.5W	\$3,725.00	\$3,190.18
336320	TruckVault Inc.	C-CHTLBN3-02R	Chevrolet Trailblazer Field Ranger, dimensions: 32.5L x 44.5W	\$3,045.00	\$2,607.81
336320	TruckVault Inc.	C-CHTLBN3-02R-PT	Chevrolet Trailblazer Field Ranger, dimensions: 31.5L x 44.5W	\$3,740.00	\$3,203.02
336320	TruckVault Inc.	C-CHTLBN4-02P	Chevrolet Trailblazer Captain CC, dimensions: 29L x 44W	\$3,795.00	\$3,250.13
336320	TruckVault Inc.	C-CHTLBN5-02C	Chevrolet Trailblazer Chief LX CC, dimensions: 30.125L x 48W	\$4,545.00	\$3,892.44
336320	TruckVault Inc.	C-CHTRVN2-18I	Traverse Investigator 2 Dwr2 Drawer	\$3,325.00	\$2,847.61
336320	TruckVault Inc.	C-CHTRVN2-18N-ZC8687	Traverse CUST	\$3,605.00	\$3,087.41
336320	TruckVault Inc.	C-CHTRVN2-18S-ZC8624	Traverse Cust 2 Dwr	\$2,515.00	\$2,153.90
336320	TruckVault Inc.	C-CHTRVN3-09I	Chevrolet Traverse Investigator, dimensions: 41L x 41W	\$3,825.00	\$3,275.82
336320	TruckVault Inc.	C-CHTRVN3-09R	Traverse Field Ranger	\$3,245.00	\$2,779.09
336320	TruckVault Inc.	C-CHTRVN3-18I	Traverse Investigator	\$3,825.00	\$3,275.82
336320	TruckVault Inc.	C-CHTRVN3-18I-HT	Traverse InvestigatorHD Table	\$4,520.00	\$3,871.03
336320	TruckVault Inc.	C-CHTRVN3-18R	Traverse Field Ranger	\$3,245.00	\$2,779.09
336320	TruckVault Inc.	C-CHTRVN4-18N-ZC8465	Traverse CUST	\$3,275.00	\$2,804.79
336320	TruckVault Inc.	C-CHTRVN5-09C	Chevrolet Traverse Chief LX CC, dimensions: 30.125L x 48W	\$4,545.00	\$3,892.44
336320	TruckVault Inc.	C-CHTRVN5-09T	Chevrolet Traverse Tac Ctr, dimensions: 30.125L x 48W	\$4,545.00	\$3,892.44
336320	TruckVault Inc.	C-CHUPLN3-05I	Chevrolet Uplander Investigator, dimensions: 49.5L x 48W	\$3,925.00	\$3,361.46
336320	TruckVault Inc.	C-CHUPLN3-05I-PT	Chevrolet Uplander Investigator, dimensions: 49.5L x 48W	\$4,620.00	\$3,956.68
336320	TruckVault Inc.	C-CHUPLN3-05R-PT	Chevrolet Uplander Field Ranger, dimensions: 48L x 48W	\$4,140.00	\$3,545.59
336320	TruckVault Inc.	C-CHUPLN3-07D	Chevrolet Uplander Special Ops Ctr, dimensions: 0L x 0W	\$3,725.00	\$3,190.18
336320	TruckVault Inc.	C-CHUPLN5-05C	Chevrolet Uplander Chief LX CC, dimensions: 30.125L x 48W	\$4,545.00	\$3,892.44
336320	TruckVault Inc.	C-CHUPLN5-05P	Chevrolet Uplander Captain LX CC, dimensions: 30.125L x 48W	\$4,095.00	\$3,507.05
336320	TruckVault Inc.	C-CHUPLN6-05C	Chevrolet Uplander Chief LX CC, dimensions: 0L x 0W	\$4,845.00	\$4,149.37
336320	TruckVault Inc.	C-CRPACM1-17N-C1-ZC11519	Custom Magnum 1 Dwr	\$2,505.00	\$2,145.34
336320	TruckVault Inc.	C-CRPACN3-04D	Pacifica Special Ops Ctr	\$3,725.00	\$3,190.18
336320	TruckVault Inc.	C-CRPACN3-17I	Pacifica Investigator	\$3,925.00	\$3,361.46
336320	TruckVault Inc.	C-CRVOYN2-20N-ZC10498	VoyagerC10498	\$2,885.00	\$2,470.78
336320	TruckVault Inc.	C-CRVOYN3-20I	Voyager Investigator	\$3,925.00	\$3,361.46
336320	TruckVault Inc.	C-CRVOYN3-20N-ZC11776	Voyager Custom	\$4,112.00	\$3,521.61
336320	TruckVault Inc.	C-DGCVNN3-01I	Dodge Caravan Investigator, dimensions: 42L x 48W	\$3,825.00	\$3,275.82
336320	TruckVault Inc.	C-DGCVNN5-01P	Dodge Caravan Captain LX CC, dimensions: 0L x 0W	\$4,095.00	\$3,507.05
336320	TruckVault Inc.	C-DGCVNN5-01P-PT	Dodge Caravan Captain LX CC, dimensions: 0L x 0W	\$4,095.00	\$3,507.05
336320	TruckVault Inc.	C-DGCVNN5-08P	Dodge Caravan Captain LX CC, dimensions: 0L x 0W	\$4,095.00	\$3,507.05
336320	TruckVault Inc.	C-DGDURN2-11N-HD-ZC9180	Durango CUST CC	\$2,975.00	\$2,547.86
336320	TruckVault Inc.	C-DGDURN1-11N-TR-L1-HG-ZC8528	Durango Custom	\$3,615.00	\$3,095.97
336320	TruckVault Inc.	C-DGDURN2-11I	Durango Investigator 2 Dwr	\$3,325.00	\$2,847.61
336320	TruckVault Inc.	C-DGDURN2-11I-PP-TR	Durango 2 Dwr Investigator	\$3,325.00	\$2,847.61
336320	TruckVault Inc.	C-DGDURN2-11I-TR	Durango 2 Dwr Investigator	\$3,325.00	\$2,847.61
336320	TruckVault Inc.	C-DGDURN2-11N-C1-ZC8490	Durango CUST CC	\$3,615.00	\$3,095.97
336320	TruckVault Inc.	C-DGDURN2-11N-C1-ZC9441	Durango Custom 2 Dwr	\$3,155.00	\$2,702.02
336320	TruckVault Inc.	C-DGDURN2-11N-C1-ZC9941	Durango Custom 2 Dwr	\$3,155.00	\$2,702.02
336320	TruckVault Inc.	C-DGDURN2-11N-TR-C1-ZC10429	Durango CustomC10429	\$1,485.00	\$1,271.79
336320	TruckVault Inc.	C-DGDURN2-11N-TR-HT-C1-DR6	Durango Drone Responder 6	\$6,995.00	\$5,990.68
336320	TruckVault Inc.	C-DGDURN2-11N-TR-HT-C1-ZC9009	Durango Custom	\$4,275.00	\$3,661.21
336320	TruckVault Inc.	C-DGDURN2-11N-TR-ZC11152	Durango 2 Dwr CustomC11152	\$3,385.00	\$2,898.99
336320	TruckVault Inc.	C-DGDURN2-11N-TR-ZC8741	Durango 2 Dwr Cust Stack	\$3,605.00	\$3,087.41
336320	TruckVault Inc.	C-DGDURN2-11N-ZC11152	Durango CUST CC,Std- Mag 1 Dwr Stack	\$3,385.00	\$2,898.99
336320	TruckVault Inc.	C-DGDURN2-11N-ZC9017	Durango 2 Dwr Cust Stack	\$3,605.00	\$3,087.41
336320	TruckVault Inc.	C-DGDURN2-11N-ZC9180	Durango Custom	\$2,975.00	\$2,547.86
336320	TruckVault Inc.	C-DGDURN3-04D	Dodge Durango Special Ops CC, dimensions: 42L x 48W	\$3,825.00	\$3,275.82

336320	TruckVault Inc.	C-DGDURN3-04D-PT	Dodge Durango CC, dimensions: 42L x 48W	\$4,520.00	\$3,871.03
336320	TruckVault Inc.	C-DGDURN3-04I	Dodge Durango Investigator, dimensions: 42L x 46.5W	\$3,825.00	\$3,275.82
336320	TruckVault Inc.	C-DGDURN3-04R	Dodge Durango Field Ranger, dimensions: 42L x 46.5W	\$3,245.00	\$2,779.09
336320	TruckVault Inc.	C-DGDURN3-04R-PP	Dodge Durango Field Ranger, dimensions: 39L x 46.5W	\$3,245.00	\$2,779.09
336320	TruckVault Inc.	C-DGDURN3-07D	Dodge Durango Special Ops CC, dimensions: 42L x 45.5W	\$3,825.00	\$3,275.82
336320	TruckVault Inc.	C-DGDURN3-07D-PT	Dodge Durango CC, dimensions: 42L x 45.5W	\$4,520.00	\$3,871.03
336320	TruckVault Inc.	C-DGDURN3-07I	Dodge Durango Investigator, dimensions: 42L x 45.5W	\$3,825.00	\$3,275.82
336320	TruckVault Inc.	C-DGDURN3-07R	Dodge Durango Field Ranger, dimensions: 42L x 45.5W	\$3,245.00	\$2,779.09
336320	TruckVault Inc.	C-DGDURN3-07R-PP	Dodge Durango Field Ranger, dimensions: 39L x 45.5W	\$3,245.00	\$2,779.09
336320	TruckVault Inc.	C-DGDURN3-11D	Dodge Durango Special Ops CC, dimensions: 42L x 45.5W	\$3,825.00	\$3,275.82
336320	TruckVault Inc.	C-DGDURN3-11D-HT	Durango CCSpecial Ops, HD Table	\$4,520.00	\$3,871.03
336320	TruckVault Inc.	C-DGDURN3-11D-PP-HT	Durango CC Cage Present	\$4,260.00	\$3,648.36
336320	TruckVault Inc.	C-DGDURN3-11D-PT	Dodge Durango CC, dimensions: 42L x 45.5W	\$4,520.00	\$3,871.03
336320	TruckVault Inc.	C-DGDURN3-11D-TR	Dodge Durango Special Ops CC, dimensions: 44L x 40W	\$3,825.00	\$3,275.82
336320	TruckVault Inc.	C-DGDURN3-11D-ZC11353	Durango Special Ops CC	\$3,865.00	\$3,310.08
336320	TruckVault Inc.	C-DGDURN3-11I	Dodge Durango Investigator, dimensions: 41L x 40W	\$3,825.00	\$3,275.82
336320	TruckVault Inc.	C-DGDURN3-11I-PP	Dodge Durango Investigator, dimensions: 38L x 40W	\$3,825.00	\$3,275.82
336320	TruckVault Inc.	C-DGDURN3-11I-PP-TR	Durango Investigator	\$3,825.00	\$3,275.82
336320	TruckVault Inc.	C-DGDURN3-11I-TR	Dodge Durango Investigator, dimensions: 41L x 40W	\$3,825.00	\$3,275.82
336320	TruckVault Inc.	C-DGDURN3-11I-TR-HT	Durango Investigator	\$4,520.00	\$3,871.03
336320	TruckVault Inc.	C-DGDURN3-11N-C2-TR-ZC8200	Durango CUST	\$3,185.00	\$2,727.71
336320	TruckVault Inc.	C-DGDURN3-11N-HT-ZC11424	Durango Custom	\$4,465.00	\$3,823.93
336320	TruckVault Inc.	C-DGDURN3-11N-PP-TR-ZC8348	Durango CUST	\$3,275.00	\$2,804.79
336320	TruckVault Inc.	C-DGDURN3-11N-PP-ZC8527	Durango Custom	\$3,955.00	\$3,387.15
336320	TruckVault Inc.	C-DGDURN3-11N-TR-HT-ZC9984	Durango CustomC9984	\$4,245.00	\$3,635.52
336320	TruckVault Inc.	C-DGDURN3-11N-TR-PP-ZC9538	Durango Custom	\$3,885.00	\$3,327.20
336320	TruckVault Inc.	C-DGDURN3-11N-TR-PT-ZC7699	Durango Cust Drone Vault	\$6,995.00	\$5,990.68
336320	TruckVault Inc.	C-DGDURN3-11N-TR-ZC9529	Durango Custom	\$3,885.00	\$3,327.20
336320	TruckVault Inc.	C-DGDURN3-11N-ZC8760	Durango 3 Drawer Stacked	\$3,675.00	\$3,147.36
336320	TruckVault Inc.	C-DGDURN3-11N-ZC9902	Durango 3 Drawer Stacked	\$3,795.00	\$3,250.13
336320	TruckVault Inc.	C-DGDURN3-11R	Dodge Durango Field Ranger, dimensions: 41L x 40W	\$3,245.00	\$2,779.09
336320	TruckVault Inc.	C-DGDURN3-11R-PP	Dodge Durango Field Ranger, dimensions: 42L x 45.5W	\$3,245.00	\$2,779.09
336320	TruckVault Inc.	C-DGDURN3-11R-PT	Dodge Durango Field Ranger, dimensions: 39L x 40W	\$3,940.00	\$3,374.31
336320	TruckVault Inc.	C-DGDURN3-11R-TR	Durango Field Ranger	\$3,245.00	\$2,779.09
336320	TruckVault Inc.	C-DGDURN3-11R-TR-HT	Durango Field Ranger	\$3,940.00	\$3,374.31
336320	TruckVault Inc.	C-DGDURN3-98D	Dodge Durango Special Ops CC, dimensions: 42L x 48W	\$3,825.00	\$3,275.82
336320	TruckVault Inc.	C-DGDURN4-11N-TR-C1-ZC10866A	Durango CustomC10866A	\$5,215.00	\$4,466.25
336320	TruckVault Inc.	C-DGDURN4-11N-TR-ZC8633	Durango CUST	\$5,325.00	\$4,560.45
336320	TruckVault Inc.	C-DGDURN4-11N-ZC9818	Durango Custom	\$4,285.00	\$3,669.77
336320	TruckVault Inc.	C-DGDURN4-11P	Dodge Durango Captain CC, dimensions: 30.125L x 48W	\$3,795.00	\$3,250.13
336320	TruckVault Inc.	C-DGDURN5-04C	Dodge Durango Chief LX CC, dimensions: 30.125L x 48W	\$4,545.00	\$3,892.44
336320	TruckVault Inc.	C-DGDURN5-07C	Dodge Durango Chief LX CC, dimensions: 43L x 47W	\$4,545.00	\$3,892.44
336320	TruckVault Inc.	C-DGDURN5-07T	Dodge Durango Tac Center, dimensions: 30.125L x 40W	\$4,545.00	\$3,892.44
336320	TruckVault Inc.	C-DGDURN5-11C	Dodge Durango Chief LX CC, dimensions: 30.125L x 40W	\$4,545.00	\$3,892.44
336320	TruckVault Inc.	C-DGDURN5-11C-TR	Durango Chief LX CC	\$4,545.00	\$3,892.44
336320	TruckVault Inc.	C-DGDURN5-11N-TR-ZC8859	Durango Custom	\$4,755.00	\$4,072.29
336320	TruckVault Inc.	C-DGDURN5-11P-TR	Durango 5 Drawer Captain CC	\$4,095.00	\$3,507.05
336320	TruckVault Inc.	C-DGDURN5-11T	Dodge Durango Tac Center, dimensions: 30.125L x 40W	\$4,545.00	\$3,892.44
336320	TruckVault Inc.	C-DGDURN5-99C	Dodge Durango Chief LX CC, dimensions: 30.125L x 43W	\$4,545.00	\$3,892.44
336320	TruckVault Inc.	C-DGGCVN2-08N-ZC9468	Grand Caravan Custom	\$3,065.00	\$2,624.94
336320	TruckVault Inc.	C-DGGCVN3-08I	Dodge Grand Caravan, dimensions: 48L x 47W	\$3,925.00	\$3,361.46
336320	TruckVault Inc.	C-DGGCVN3-08R	Dodge Grand Caravan Field Ranger, dimensions: 0L x 0W	\$3,445.00	\$2,950.38
336320	TruckVault Inc.	C-DGGCVN5-08C-HT	Grand Caravan Chief LX CC	\$5,240.00	\$4,487.66
336320	TruckVault Inc.	C-DGGCVN5-08C-PT	Grand Caravan Chief LX CC	\$5,240.00	\$4,487.66
336320	TruckVault Inc.	C-DGGCVN5-08P	Dodge Grand Caravan Captain LX CC, dimensions: 30.125L x 47W	\$4,095.00	\$3,507.05
336320	TruckVault Inc.	C-DGJNYN2-09I	Journey Investigator2 Drawer	\$3,225.00	\$2,761.96
336320	TruckVault Inc.	C-DGJNYN3-09I	Journey Investigator	\$3,625.00	\$3,104.53
336320	TruckVault Inc.	C-DGPMVM2-15L-VP	ProMaster Surveyor	\$3,905.00	\$3,344.33
336320	TruckVault Inc.	C-DGPMVM4-10N-HT-C4-ZC10303	ProMaster Van CustomC10303	\$5,755.00	\$4,928.72
336320	TruckVault Inc.	C-DGRAMM2-09S-PC-VP	Ram Pickup Surveyor	\$3,905.00	\$3,344.33
336320	TruckVault Inc.	C-DGRAMN2-03S-P5-HP-ZC11475	Ram Pickup Custom	\$3,795.00	\$3,250.13
336320	TruckVault Inc.	C-DGRAMN2-03S-P5-ZC10769	Ram Pickup CustomC10769	\$3,055.00	\$2,616.37
336320	TruckVault Inc.	C-DGRAMN2-09S-P5-TB-PW-ZC10906	Dodge Ram PickupC10906; Ram Boxes	\$4,005.00	\$3,429.97
336320	TruckVault Inc.	C-DGRAMN2-09S-P5-TB-PW-ZC9872	Dodge Ram Pickup	\$5,065.00	\$4,337.78
336320	TruckVault Inc.	C-DGRAMN2-09S-PC-HN-PW-ZC10046	Ram Pickup CustomC10046	\$3,925.00	\$3,361.46
336320	TruckVault Inc.	C-DGRAMN2-19S-PC-ZC10769	Ram Pickup CustomC10769	\$3,055.00	\$2,616.37

336320	TruckVault Inc.	C-DGRAMN3-02I	Dodge Ram Pickup Investigator, dimensions: 54L x 48W	\$3,795.00	\$3,250.13
336320	TruckVault Inc.	C-DGRAMN3-02S-CR	Ram Field Ranger	\$4,545.00	\$3,892.44
336320	TruckVault Inc.	C-DGRAMN3-03L-P5-BH-PW	Ram Pickup BowHunter	\$5,145.00	\$4,406.30
336320	TruckVault Inc.	C-DGRAMN3-03S-P5-BH	Dodge Ram Pickup BowHunter, dimensions: 72L x 48W	\$4,195.00	\$3,592.70
336320	TruckVault Inc.	C-DGRAMN3-03S-P5-BH-PW	Ram Pickup BowHunter	\$4,845.00	\$4,149.37
336320	TruckVault Inc.	C-DGRAMN3-03S-P5-C3-BS-ZC10444	Ram Pickup CustomC10444	\$3,475.00	\$2,976.07
336320	TruckVault Inc.	C-DGRAMN3-03S-P5-C6-ZC10515	Ram CustomC10515	\$5,395.00	\$4,620.40
336320	TruckVault Inc.	C-DGRAMN3-03S-P5-CR-PW	Ram Pickup Field Ranger	\$5,195.00	\$4,449.12
336320	TruckVault Inc.	C-DGRAMN3-03S-P5-PW-ZC11831B	Ram Pickup Field Ranger Shortened on Driver's ISde	\$5,490.00	\$4,701.76
336320	TruckVault Inc.	C-DGRAMN3-03S-P5-PW-ZC9583	Std 2 dwr w/map board dwr AW	\$4,975.00	\$4,260.71
336320	TruckVault Inc.	C-DGRAMN3-09I-PC	Ram Pickup Investigator	\$3,825.00	\$3,275.82
336320	TruckVault Inc.	C-DGRAMN3-09S-P5-TB-CR	Dodge Ram Field Ranger, dimensions: 72L x 53W	\$4,025.00	\$3,447.10
336320	TruckVault Inc.	C-DGRAMN3-09S-P5-TB-PW-ZC10206	Dodge Ram PickupC10206	\$5,065.00	\$4,337.78
336320	TruckVault Inc.	C-DGRAMN3-09S-PC-CR	Ram Pickup Field Ranger	\$4,345.00	\$3,721.16
336320	TruckVault Inc.	C-DGRAMN3-09S-PC-CR-PW	Ram Pickup Field Ranger	\$4,895.00	\$4,192.19
336320	TruckVault Inc.	C-DGRAMN3-09S-PC-TB-BH-PW	Ram Pickup BowHunter	\$4,545.00	\$3,892.44
336320	TruckVault Inc.	C-DGRAMN3-19D-PC	Dodge Ram Special Ops Ctr	\$4,275.00	\$3,661.21
336320	TruckVault Inc.	C-DGRAMN3-19S-CR	Ram Field Ranger	\$4,545.00	\$3,892.44
336320	TruckVault Inc.	C-DGRAMN3-19S-PC-CR	Ram Pickup Field Ranger	\$3,725.00	\$3,190.18
336320	TruckVault Inc.	C-DGRAMN3-19S-PC-CR-PW	Ram Pickup Field Ranger5' 7" Bed; Crew Cab; A/W	\$4,895.00	\$4,192.19
336320	TruckVault Inc.	C-DGRAMN3-19S-PC-C4-ZC10767A	Ram Pickup Seat AreaC10767A	\$1,955.00	\$1,674.31
336320	TruckVault Inc.	C-DGRVCN5-12P-PT	Dodge Ram CV Captain LX CC, dimensions: 31.125L x 48W	\$4,790.00	\$4,102.27
336320	TruckVault Inc.	C-FDBCON5-88C	Ford Bronco Chief LX CC, dimensions: 30.125L x 48W	\$4,545.00	\$3,892.44
336320	TruckVault Inc.	C-FDBCON6-88C	Ford Bronco Chief LX CC, dimensions: 30.125L x 48W	\$4,845.00	\$4,149.37
336320	TruckVault Inc.	C-FDEDN3-07D	Ford Edge Special-Ops, dimensions: 31L x 38.5W	\$3,725.00	\$3,190.18
336320	TruckVault Inc.	C-FDEDN3-07I	Ford Edge Investigator, dimensions: 24L x 38.5W	\$3,725.00	\$3,190.18
336320	TruckVault Inc.	C-FDEDN3-07R	Ford Ford Edge Field Ranger, dimensions: 30L x 38.5W	\$3,045.00	\$2,607.81
336320	TruckVault Inc.	C-FDEDN3-15R-HT	Edge Field Ranger	\$3,740.00	\$3,203.02
336320	TruckVault Inc.	C-FDESCN2-14N-ZC8327	Escape Custom	\$2,985.00	\$2,556.42
336320	TruckVault Inc.	C-FDESCN3-05I	Ford Escape Investigator, dimensions: 0L x 0W	\$3,825.00	\$3,275.82
336320	TruckVault Inc.	C-FDESCN3-08D-PH	Ford Escape Special-Ops, dimensions: 0L x 0W	\$3,725.00	\$3,190.18
336320	TruckVault Inc.	C-FDESCN3-08I	Ford Escape Investigator, dimensions: 24L x 40W	\$3,725.00	\$3,190.18
336320	TruckVault Inc.	C-FDESCN3-08I-HT	Escape Investigator	\$4,420.00	\$3,785.39
336320	TruckVault Inc.	C-FDESCN3-14R	Ford Escape Field Ranger	\$3,045.00	\$2,607.81
336320	TruckVault Inc.	C-FDESCN5-01C	Ford Escape Chief LX CC, dimensions: 23.5L x 40W	\$4,545.00	\$3,892.44
336320	TruckVault Inc.	C-FDESCN5-08C	Ford Escape LX CC, dimensions: 23.5L x 39W	\$4,545.00	\$3,892.44
336320	TruckVault Inc.	C-FDESCN5-08C-PH-PT	Ford Escape LX CC, dimensions: 23L x 39W	\$5,240.00	\$4,487.66
336320	TruckVault Inc.	C-FDESCN5-08C-PT	Ford Escape LX CC, dimensions: 21.25L x 40W	\$5,240.00	\$4,487.66
336320	TruckVault Inc.	C-FDESCN6-01C	Ford Escape Chief LX CC, dimensions: 26.25L x 40W	\$4,845.00	\$4,149.37
336320	TruckVault Inc.	C-FDESCN6-14C	Escape Chief CC	\$4,845.00	\$4,149.37
336320	TruckVault Inc.	C-FDESEN3-92D-PT	Ford Full Size Van Special Ops Ctr, dimensions: 45L x 48W	\$4,520.00	\$3,871.03
336320	TruckVault Inc.	C-FDESEN3-92R	Ford Full Size Van Field Ranger, dimensions: 50L x 48W	\$3,445.00	\$2,950.38
336320	TruckVault Inc.	C-FDESEN5-98C	Ford Full Size Van Chief LX CC, dimensions: 30.125L x 48W	\$4,545.00	\$3,892.44
336320	TruckVault Inc.	C-FDESEN6-98C	Ford Full Size Van Chief LX CC, dimensions: 30.125L x 48W	\$4,845.00	\$4,149.37
336320	TruckVault Inc.	C-FDESEN7-06E	Ford Full Size Van Office Ctr, dimensions: 109L x 59W	\$6,285.00	\$7,095.47
336320	TruckVault Inc.	C-FDEXCN3-00D	Ford Excursion Special Ops Ctr, dimensions: 45L x 45W	\$3,825.00	\$3,275.82
336320	TruckVault Inc.	C-FDEXCN3-00I	Ford Excursion Investigator, dimensions: 57L x 45W	\$3,925.00	\$3,361.46
336320	TruckVault Inc.	C-FDEXCN3-00I-PT	Ford Excursion Investigator, dimensions: 54L x 45W	\$4,620.00	\$3,956.68
336320	TruckVault Inc.	C-FDEXCN3-00N-C1-ZC11773A	Excursion Custom	\$7,315.00	\$6,264.74
336320	TruckVault Inc.	C-FDEXCN3-00N-HT-ZC11356	Excursion Custom	\$5,045.00	\$4,320.65
336320	TruckVault Inc.	C-FDEXCN3-00R	Ford Excursion Field Ranger, dimensions: 54L x 45W	\$3,445.00	\$2,950.38
336320	TruckVault Inc.	C-FDEXCN4-96P	Ford Excursion Captain CC, dimensions: 30.125L x 48W	\$3,795.00	\$3,250.13
336320	TruckVault Inc.	C-FDEXCN4-96P-PT	Ford Excursion Captain CC, dimensions: 0L x 0W	\$4,095.00	\$3,507.05
336320	TruckVault Inc.	C-FDEXCN5-00C	Ford Excursion Chief LX CC, dimensions: 30.125L x 48W	\$4,545.00	\$3,892.44
336320	TruckVault Inc.	C-FDEXCN5-00P	Ford Excursion Captain LX CC, dimensions: 30.125L x 48W	\$4,095.00	\$3,507.05
336320	TruckVault Inc.	C-FDEXCN6-00C	Ford Excursion Chief LX CC, dimensions: 30.125L x 48W	\$4,845.00	\$4,149.37
336320	TruckVault Inc.	C-FDEXCN6-00T	Ford Excursion Tac Ctr, dimensions: 30.125L x 48W	\$4,845.00	\$4,149.37
336320	TruckVault Inc.	C-FDEXCN6-96T	Ford Excursion Tac Ctr, dimensions: 30.125L x 48W	\$4,845.00	\$4,149.37
336320	TruckVault Inc.	C-FDEXLM2-07F-VP	Expedition EL Surveyor	\$3,905.00	\$3,344.33
336320	TruckVault Inc.	C-FDEXLN2-07S-ZC11344	Expedition EL CustomC11344	\$3,065.00	\$2,624.94
336320	TruckVault Inc.	C-FDEXLN3-07D	Ford Expedition EL Special Ops Ctr, dimensions: 61L x 53W	\$4,025.00	\$3,447.10
336320	TruckVault Inc.	C-FDEXLN3-07D-HT	Expedition EL Special Ops Ctr	\$4,720.00	\$4,042.32
336320	TruckVault Inc.	C-FDEXLN3-07D-PS	Ford Expedition EL Special Ops Ctr, dimensions: 61L x 53W	\$4,025.00	\$3,447.10
336320	TruckVault Inc.	C-FDEXLN3-07D-PT	Ford Expedition EL Special Ops Ctr, dimensions: 60L x 53W	\$4,720.00	\$4,042.32
336320	TruckVault Inc.	C-FDEXLN3-07D-PT-BS	Ford Expedition EL Special Ops Ctr, dimensions: 60L x 53W	\$4,720.00	\$4,042.32
336320	TruckVault Inc.	C-FDEXLN3-07I	Ford Expedition EL Investigator, dimensions: 52L x 53W	\$3,925.00	\$3,361.46

336320	TruckVault Inc.	C-FDEXLN3-071-PS-PT	Ford Expedition EL Investigator, dimensions: 52L x 53W	\$4,620.00	\$3,956.68
336320	TruckVault Inc.	C-FDEXLN3-071-PT	Ford Expedition EL Investigator, dimensions: 52L x 53W	\$4,620.00	\$3,956.68
336320	TruckVault Inc.	C-FDEXLN3-07R-TR	Expedition EL Field Ranger3rd Row Removed	\$3,645.00	\$3,121.66
336320	TruckVault Inc.	C-FDEXLN4-07F-VP	Expedition EL Surveyor	\$5,585.00	\$4,783.12
336320	TruckVault Inc.	C-FDEXLN4-07P	Ford Expedition EL Captain CC, dimensions: 30.125L x 48W	\$3,795.00	\$3,250.13
336320	TruckVault Inc.	C-FDEXLN5-07C	Ford Expedition EL Chief LX CC, dimensions: 30.125L x 48W	\$4,545.00	\$3,892.44
336320	TruckVault Inc.	C-FDEXLN5-07C-PT	Expedition EL Chief LX CC	\$5,240.00	\$4,487.66
336320	TruckVault Inc.	C-FDEXLN5-07P	Ford Expedition EL Captain LX CC, dimensions: 30.125L x 48W	\$4,095.00	\$3,507.05
336320	TruckVault Inc.	C-FDEXLN5-07T	Ford Expedition EL Tac Ctr, dimensions: 30.125L x 48W	\$4,545.00	\$3,892.44
336320	TruckVault Inc.	C-FDEXPN0-18N-C2-ZC8981	Expedition Custom	\$1,345.00	\$1,151.89
336320	TruckVault Inc.	C-FDEXPN0-18N-C3-HT-ZC10632	Expedition CustomC10632	\$2,375.00	\$2,034.01
336320	TruckVault Inc.	C-FDEXPN0-18N-C3-TT-ZC9383	Expedition Open Cubbies	\$2,485.00	\$2,128.21
336320	TruckVault Inc.	C-FDEXPN0-18N-TR-C2-ZC8981	Expedition Custom erd Removed	\$1,345.00	\$1,151.89
336320	TruckVault Inc.	C-FDEXPN0-18N-TR-C3-HT-ZC10632	Expedition Custom, 3rd Seat Removed	\$2,375.00	\$2,034.01
336320	TruckVault Inc.	C-FDEXPN0-18N-TR-HT-C7-C10590A	Expedition CustomC10590A	\$6,995.00	\$5,990.68
336320	TruckVault Inc.	C-FDEXPN1-03N-HT-C1-ZC11126	Expedition CustomC11126	\$5,315.00	\$4,551.89
336320	TruckVault Inc.	C-FDEXPN1-03N-TR-C4-ZC10012	Expedition CustomC10012	\$4,445.00	\$3,806.80
336320	TruckVault Inc.	C-FDEXPN2-03I	Expedition 2 Dwr Investigator	\$3,325.00	\$2,847.61
336320	TruckVault Inc.	C-FDEXPN2-03N-C1-ZC10006	Expedition Custom	\$3,025.00	\$2,590.68
336320	TruckVault Inc.	C-FDEXPN2-03N-HT-C1-ZC9010	Expedition Custom	\$4,275.00	\$3,661.21
336320	TruckVault Inc.	C-FDEXPN2-03N-VC	Ford Expedition Surveyor, dimensions: 30.125L x 48W	\$3,095.00	\$2,650.63
336320	TruckVault Inc.	C-FDEXPN2-18I-TR	Expedition 2 Dwr Investigator3rd Row Removed or SSV	\$3,325.00	\$2,847.61
336320	TruckVault Inc.	C-FDEXPN2-18I-TR-PP	Expedition 2 Dwr Investigator	\$3,325.00	\$2,847.61
336320	TruckVault Inc.	C-FDEXPN2-18N-C1-ZC10031	Expedition Custom	\$3,025.00	\$2,590.68
336320	TruckVault Inc.	C-FDEXPN2-18N-C2-TT-ZC9091	Expedition Custom	\$5,115.00	\$4,380.60
336320	TruckVault Inc.	C-FDEXPN2-18N-C3-TR-ZC9619	Expedition Custom	\$4,065.00	\$3,481.36
336320	TruckVault Inc.	C-FDEXPN2-18N-C4-ZC8924	Expedition Custom	\$4,785.00	\$4,097.98
336320	TruckVault Inc.	C-FDEXPN2-18N-TR-C2-HT-ZC9284	Expedition Custom	\$5,185.00	\$4,440.55
336320	TruckVault Inc.	C-FDEXPN2-18N-TR-C2-TT-ZC9091	Expedition Custom, 3rd Seat Removed	\$5,115.00	\$4,380.60
336320	TruckVault Inc.	C-FDEXPN2-18N-TR-C2-ZC11262A	Expedition CustomC11262A	\$3,485.00	\$2,984.63
336320	TruckVault Inc.	C-FDEXPN2-18N-TR-C3-ZC9420	Expedition CustomC9420	\$3,145.00	\$2,693.45
336320	TruckVault Inc.	C-FDEXPN2-18N-TR-C4-ZC8924	Expedition Custom	\$4,785.00	\$4,097.98
336320	TruckVault Inc.	C-FDEXPN2-18N-TR-TT-C1-ZC10246	Expedition CustomC10246	\$5,735.00	\$4,911.59
336320	TruckVault Inc.	C-FDEXPN2-18N-TR-ZC10232	Expedition 2 Dwr stacked2 Drawer 3rd seat removed	\$3,395.00	\$2,907.56
336320	TruckVault Inc.	C-FDEXPN2-18N-TR-ZC11031	Expedition CustomC11031	\$2,465.00	\$2,111.08
336320	TruckVault Inc.	C-FDEXPN2-18N-TR-ZC11212	Expedition Custom	\$3,795.00	\$3,250.13
336320	TruckVault Inc.	C-FDEXPN2-18N-TR-ZC9006	Expedition Custom	\$4,045.00	\$3,464.23
336320	TruckVault Inc.	C-FDEXPN2-18N-TR-ZC9550	Expedition Custom	\$2,885.00	\$2,470.78
336320	TruckVault Inc.	C-FDEXPN2-18N-ZC10232	Expedition 2 Dwr stacked2 Drawer	\$3,395.00	\$2,907.56
336320	TruckVault Inc.	C-FDEXPN2-18N-ZC9006	Expedition Custom	\$3,535.00	\$3,027.46
336320	TruckVault Inc.	C-FDEXPN3-03D	Ford Expedition Special Ops Ctr, dimensions: 45L x 48W	\$3,825.00	\$3,275.82
336320	TruckVault Inc.	C-FDEXPN3-03D-HT	Ford Expedition Special Ops Ctr, dimensions: 43L x 48W	\$4,520.00	\$3,871.03
336320	TruckVault Inc.	C-FDEXPN3-03D-PP	Ford Expedition Special Ops Ctr, dimensions: 42L x 48W	\$3,825.00	\$3,275.82
336320	TruckVault Inc.	C-FDEXPN3-03D-PS	Ford Expedition Special Ops Ctr, dimensions: 45L x 48W	\$3,825.00	\$3,275.82
336320	TruckVault Inc.	C-FDEXPN3-03D-PT	Ford Expedition Special Ops Ctr, dimensions: 45L x 48W	\$4,520.00	\$3,871.03
336320	TruckVault Inc.	C-FDEXPN3-03I	Ford Expedition Investigator, dimensions: 45L x 48W	\$3,825.00	\$3,275.82
336320	TruckVault Inc.	C-FDEXPN3-03I-HT	Expedition Investigator	\$4,520.00	\$3,871.03
336320	TruckVault Inc.	C-FDEXPN3-03I-PP	Ford Expedition Investigator, dimensions: 42L x 48W	\$3,825.00	\$3,275.82
336320	TruckVault Inc.	C-FDEXPN3-03I-PS	Ford Expedition Investigator, dimensions: 45L x 48W	\$3,825.00	\$3,275.82
336320	TruckVault Inc.	C-FDEXPN3-03I-PS-PP	Ford Expedition Investigator, dimensions: 42L x 48W	\$3,825.00	\$3,275.82
336320	TruckVault Inc.	C-FDEXPN3-03I-PS-PT	Ford Expedition Investigator, dimensions: 44L x 48W	\$4,520.00	\$3,871.03
336320	TruckVault Inc.	C-FDEXPN3-03I-PT	Ford Expedition Investigator, dimensions: 44L x 48W	\$4,520.00	\$3,871.03
336320	TruckVault Inc.	C-FDEXPN3-03I-TR	Ford Expedition Investigator, dimensions: 45L x 48W	\$3,825.00	\$3,275.82
336320	TruckVault Inc.	C-FDEXPN3-03I-TR-HT	Ford Expedition Investigator, dimensions: 46L x 48W	\$4,520.00	\$3,871.03
336320	TruckVault Inc.	C-FDEXPN3-03N-C2-ZC10408	Expedition CustomC10408	\$3,925.00	\$3,361.46
336320	TruckVault Inc.	C-FDEXPN3-03N-PP-ZC8090	Expedition CUST CC	\$2,605.00	\$2,230.98
336320	TruckVault Inc.	C-FDEXPN3-03N-Y5	Expedition CUSTC4872	\$3,905.00	\$3,344.33
336320	TruckVault Inc.	C-FDEXPN3-03N-Y6	Expedition CUSTC6230	\$3,905.00	\$3,344.33
336320	TruckVault Inc.	C-FDEXPN3-03N-Y7	Expedition CUSTC6235	\$3,905.00	\$3,344.33
336320	TruckVault Inc.	C-FDEXPN3-03R	Ford Expedition Field Ranger, dimensions: 45L x 48W	\$3,245.00	\$2,779.09
336320	TruckVault Inc.	C-FDEXPN3-03R-HT	Ford Expedition Field Ranger, dimensions: 43L x 48W	\$3,940.00	\$3,374.31
336320	TruckVault Inc.	C-FDEXPN3-03R-PP	Ford Expedition Field Ranger, dimensions: 42L x 48W	\$3,245.00	\$2,779.09
336320	TruckVault Inc.	C-FDEXPN3-03R-PP-PT	Ford Expedition Field Ranger, dimensions: 41L x 48W	\$3,940.00	\$3,374.31
336320	TruckVault Inc.	C-FDEXPN3-03R-PS	Ford Expedition Field Ranger, dimensions: 45L x 48W	\$3,245.00	\$2,779.09
336320	TruckVault Inc.	C-FDEXPN3-03R-PT	Ford Expedition Field Ranger, dimensions: 44L x 48W	\$3,940.00	\$3,374.31
336320	TruckVault Inc.	C-FDEXPN3-03R-TR	Expedition Field Ranger	\$3,245.00	\$2,779.09

336320	TruckVault Inc.	C-FDEXPN3-03R-TR-PP	Expedition Field Ranger3rd Row Removed	\$3,245.00	\$2,779.09
336320	TruckVault Inc.	C-FDEXPN3-18D-TR	Expedition Special Ops Ctr	\$3,825.00	\$3,275.82
336320	TruckVault Inc.	C-FDEXPN3-18D-TR-PP	Expedition Special Ops Ctr	\$3,825.00	\$3,275.82
336320	TruckVault Inc.	C-FDEXPN3-18D-ZC11457	Expedition Special Ops Ctr	\$4,005.00	\$3,429.97
336320	TruckVault Inc.	C-FDEXPN3-18I	Expedition Investigator	\$3,825.00	\$3,275.82
336320	TruckVault Inc.	C-FDEXPN3-18I-PT	Expedition Investigator	\$4,520.00	\$3,871.03
336320	TruckVault Inc.	C-FDEXPN3-18I-TR	Expedition Investigator	\$3,825.00	\$3,275.82
336320	TruckVault Inc.	C-FDEXPN3-18I-TR-HT	Expedition Investigator	\$4,520.00	\$3,871.03
336320	TruckVault Inc.	C-FDEXPN3-18I-TR-PP	Expedition Investigator	\$3,825.00	\$3,275.82
336320	TruckVault Inc.	C-FDEXPN3-18I-TR-PP-ZC11833	Expedition Investigator Custom Length	\$4,520.00	\$3,871.03
336320	TruckVault Inc.	C-FDEXPN3-18N-C1-ZC10657	Expedition CustomC10657	\$2,925.00	\$2,505.04
336320	TruckVault Inc.	C-FDEXPN3-18N-C2-ZC8685	Expedition Custom	\$5,305.00	\$4,543.32
336320	TruckVault Inc.	C-FDEXPN3-18N-TF-HM-C2-ZC11224	Expedition Custom	\$4,745.00	\$4,063.73
336320	TruckVault Inc.	C-FDEXPN3-18N-TR-C1-ZC10657	Expedition CustomC10657; 3rd Row Removed	\$2,925.00	\$2,505.04
336320	TruckVault Inc.	C-FDEXPN3-18N-TR-C7-ZC8899	Expedition Custom Command	\$6,155.00	\$6,984.13
336320	TruckVault Inc.	C-FDEXPN3-18N-TR-PP-ZC11016A	Expedition CustomC11016A	\$3,125.00	\$2,676.32
336320	TruckVault Inc.	C-FDEXPN3-18N-TR-PT-ZC8525	Expedition CUST	\$4,305.00	\$3,686.90
336320	TruckVault Inc.	C-FDEXPN3-18N-TR-ZC11097A	Expedition CustomC11097	\$3,975.00	\$3,404.28
336320	TruckVault Inc.	C-FDEXPN3-18N-TR-ZC8087	Expedition Custom	\$3,975.00	\$3,404.28
336320	TruckVault Inc.	C-FDEXPN3-18N-TR-ZC8088	Expedition CustomC8087	\$3,975.00	\$3,404.28
336320	TruckVault Inc.	C-FDEXPN3-18R	Expedition Field Ranger	\$3,245.00	\$2,779.09
336320	TruckVault Inc.	C-FDEXPN3-18R-TR	Expedition Field Ranger	\$3,245.00	\$2,779.09
336320	TruckVault Inc.	C-FDEXPN3-18R-TR-HT	Expedition Field Ranger	\$3,940.00	\$3,374.31
336320	TruckVault Inc.	C-FDEXPN3-18R-TR-PP	Expedition Field Ranger3rd Row Seat Removed; Prisoner Cage	\$3,245.00	\$2,779.09
336320	TruckVault Inc.	C-FDEXPN3-96D	Ford Expedition Special Ops Ctr, dimensions: 44L x 48W	\$3,825.00	\$3,275.82
336320	TruckVault Inc.	C-FDEXPN3-96D-PS	Ford Expedition Special Ops Ctr, dimensions: 0L x 0W	\$3,725.00	\$3,190.18
336320	TruckVault Inc.	C-FDEXPN3-96I	Ford Expedition Investigator, dimensions: 42.5L x 48W	\$3,825.00	\$3,275.82
336320	TruckVault Inc.	C-FDEXPN4-03P	Ford Expedition Captain CC, dimensions: 30.125L x 48W	\$3,795.00	\$3,250.13
336320	TruckVault Inc.	C-FDEXPN4-03P-PS	Ford Expedition Captain CC, dimensions: 30.125L x 48W	\$3,795.00	\$3,250.13
336320	TruckVault Inc.	C-FDEXPN4-18N-C4-ZC8758	Expedition CUST	\$6,325.00	\$5,416.88
336320	TruckVault Inc.	C-FDEXPN4-18N-TR-C7-ZC8512	Expedition CUST	\$5,705.00	\$4,885.89
336320	TruckVault Inc.	C-FDEXPN4-18N-ZC11185C	Expedition CustomC11185C	\$4,025.00	\$3,447.10
336320	TruckVault Inc.	C-FDEXPN4-96P	Ford Expedition Captain CC, dimensions: 30.125L x 48W	\$3,795.00	\$3,250.13
336320	TruckVault Inc.	C-FDEXPN5-03C	Ford Expedition Chief LX CC, dimensions: 30.125L x 48W	\$4,545.00	\$3,892.44
336320	TruckVault Inc.	C-FDEXPN5-03C-PS	Ford Expedition Chief LX CC, dimensions: 30.125L x 48W	\$4,545.00	\$3,892.44
336320	TruckVault Inc.	C-FDEXPN5-03C-PS-PT	Ford Expedition Chief LX CC, dimensions: 30.125L x 48W	\$5,240.00	\$4,487.66
336320	TruckVault Inc.	C-FDEXPN5-03C-PT	Ford Expedition Chief LX CC, dimensions: 30.125L x 48W	\$5,240.00	\$4,487.66
336320	TruckVault Inc.	C-FDEXPN5-03C-TR	Ford Expedition Chief LX CC, dimensions: 30.125L x 48W	\$4,545.00	\$3,892.44
336320	TruckVault Inc.	C-FDEXPN5-03P	Ford Expedition Captain LX CC, dimensions: 30.125L x 48W	\$4,095.00	\$3,507.05
336320	TruckVault Inc.	C-FDEXPN5-03P-PS	Ford Expedition Captain LX CC, dimensions: 30.125L x 48W	\$4,095.00	\$3,507.05
336320	TruckVault Inc.	C-FDEXPN5-03P-PS-PT	Ford Expedition Captain LX CC, dimensions: 30.125L x 48W	\$4,790.00	\$4,102.27
336320	TruckVault Inc.	C-FDEXPN5-03P-PT	Ford Expedition Captain LX CC, dimensions: 30.125L x 48W	\$4,790.00	\$4,102.27
336320	TruckVault Inc.	C-FDEXPN5-03P-PT-T01	Expedition Captain CC	\$4,790.00	\$4,102.27
336320	TruckVault Inc.	C-FDEXPN5-03P-TR	Ford Expedition Captain LX CC, dimensions: 30.125L x 48W	\$4,095.00	\$3,507.05
336320	TruckVault Inc.	C-FDEXPN5-03T	Ford Expedition Tac Ctr, dimensions: 30.125L x 48W	\$4,545.00	\$3,892.44
336320	TruckVault Inc.	C-FDEXPN5-03T-PS	Ford Expedition Tac Ctr, dimensions: 30.125L x 48W	\$4,545.00	\$3,892.44
336320	TruckVault Inc.	C-FDEXPN5-03T-TR	Ford Expedition Tac Ctr, dimensions: 30.125L x 48W	\$4,545.00	\$3,892.44
336320	TruckVault Inc.	C-FDEXPN5-18N-TR-C4-ZC11778E	Expedition Custom	\$4,730.00	\$4,050.88
336320	TruckVault Inc.	C-FDEXPN5-18N-TR-HT-ZC9796	Expedition Custom	\$5,815.00	\$4,980.10
336320	TruckVault Inc.	C-FDEXPN5-18N-TR-ZC9997	Expedition, 3rd Seat Removed	\$3,345.00	\$2,864.74
336320	TruckVault Inc.	C-FDEXPN5-18N-ZC9997	Expedition	\$3,345.00	\$2,864.74
336320	TruckVault Inc.	C-FDEXPN5-18P	Expedition Captain LX CC	\$4,095.00	\$3,507.05
336320	TruckVault Inc.	C-FDEXPN5-18P-TR	Expedition Captain LX CC	\$4,095.00	\$3,507.05
336320	TruckVault Inc.	C-FDEXPN5-18T	Expedition Tac Ctr3rd Row Seats Folded	\$4,545.00	\$3,892.44
336320	TruckVault Inc.	C-FDEXPN5-18T-TR	Expedition Tac Ctr3rd Row Seats Removed	\$4,545.00	\$3,892.44
336320	TruckVault Inc.	C-FDEXPN5-95C	Ford Expedition Chief LX CC, dimensions: 30.125L x 48W	\$4,545.00	\$3,892.44
336320	TruckVault Inc.	C-FDEXPN5-96C	Ford Expedition Chief LX CC, dimensions: 30.125L x 48W	\$4,545.00	\$3,892.44
336320	TruckVault Inc.	C-FDEXPN5-96P	Ford Expedition Captain LX, dimensions: 30.125L x 48W	\$4,095.00	\$3,507.05
336320	TruckVault Inc.	C-FDEXPN6-03C	Ford Expedition Chief LX CC, dimensions: 30.125L x 48W	\$4,845.00	\$4,149.37
336320	TruckVault Inc.	C-FDEXPN6-03C-PS	Ford Expedition Chief LX CC, dimensions: 30.125L x 48W	\$4,845.00	\$4,149.37
336320	TruckVault Inc.	C-FDEXPN6-03C-PS-PT	Ford Expedition Chief LX CC, dimensions: 30.125L x 48W	\$5,540.00	\$4,744.58
336320	TruckVault Inc.	C-FDEXPN6-03C-PT	Ford Expedition Chief LX CC, dimensions: 30.125L x 48W	\$5,540.00	\$4,744.58
336320	TruckVault Inc.	C-FDEXPN6-03C-TR	Ford Expedition Chief LX CC, dimensions: 30.125L x 48W	\$4,845.00	\$4,149.37
336320	TruckVault Inc.	C-FDEXPN6-03E	Ford Expedition Op Ctr, dimensions: 30.125L x 48W	\$4,749.00	\$4,067.15
336320	TruckVault Inc.	C-FDEXPN6-18C	Expedition Chief LX CC	\$4,845.00	\$4,149.37
336320	TruckVault Inc.	C-FDEXPN6-18C-TR	Expedition Chief LX CC	\$4,845.00	\$4,149.37



336320	TruckVault Inc.	C-FDEXPN6-18C-TR-HT	Expedition Chief LX CC3rd Row Removed or SSV; Heavy Duty Table Extension	\$5,540.00	\$4,744.58
336320	TruckVault Inc.	C-FDEXPN6-18N-TT-ZC9126	Expedition Custom	\$5,945.00	\$5,091.44
336320	TruckVault Inc.	C-FDEXPN6-95C	Ford Expedition Chief LX CC, dimensions: 30.125L x 48W	\$4,845.00	\$4,149.37
336320	TruckVault Inc.	C-FDEXPN6-95T	Ford Expedition Tac Ctr, dimensions: 30.125L x 48W	\$4,845.00	\$4,149.37
336320	TruckVault Inc.	C-FDEXPN6-96C	Ford Expedition Chief LX CC, dimensions: 30.125L x 48W	\$4,845.00	\$4,149.37
336320	TruckVault Inc.	C-FDEXRM2-11N-PS-ZC7762	Explorer CUST CC	\$3,615.00	\$3,095.97
336320	TruckVault Inc.	C-FDEXRM2-20N-PS-ZC10618	Explorer CUST CCMag 2 Dwr Stack; C10618	\$3,725.00	\$3,190.18
336320	TruckVault Inc.	C-FDEXRM3-20N-PS-ZC10304	Explorer 3 Drawer StakedPolice Package No 3rd Row Seat	\$3,925.00	\$3,361.46
336320	TruckVault Inc.	C-FDEXRN0-11N-PS-C2-ZC10570	Explorer CustomC10570	\$3,405.00	\$2,916.12
336320	TruckVault Inc.	C-FDEXRN0-11N-PS-HT-C3-ZC10282	Explorer CustomC10282	\$3,935.00	\$3,370.03
336320	TruckVault Inc.	C-FDEXRN0-20N-C5-HT-ZC9848	Explorer Custom Cubbies	\$2,955.00	\$2,530.73
336320	TruckVault Inc.	C-FDEXRN0-20N-PS-C7-ZC11077	Explorer Custom CubbiesC11077	\$3,295.00	\$2,821.91
336320	TruckVault Inc.	C-FDEXRN1-11N-PS-C1-HT-C11057B	Explorer CustomC11057B; DR	\$3,445.00	\$2,950.38
336320	TruckVault Inc.	C-FDEXRN1-11N-PS-C2-ZC8989	Explorer Custom	\$2,205.00	\$1,888.41
336320	TruckVault Inc.	C-FDEXRN1-11N-PS-C3-ZC8061	Explorer CUST	\$2,665.00	\$2,282.37
336320	TruckVault Inc.	C-FDEXRN1-11N-PS-HT-C1-C11553B	Explorer Custom	\$4,900.00	\$4,196.47
336320	TruckVault Inc.	C-FDEXRN1-11N-TF-HT-C1-ZC1155	Explorer Custom	\$4,900.00	\$4,196.47
336320	TruckVault Inc.	C-FDEXRN1-20N-PS-C2-ZC9979	Explorer Map Board Cubbies, Power Plugs	\$2,505.00	\$2,145.34
336320	TruckVault Inc.	C-FDEXRN2-06I	Explorer Investigator 2 Dwr	\$3,325.00	\$2,847.61
336320	TruckVault Inc.	C-FDEXRN2-11D-PS-LT	2 Dwr Explorer Special Ops Ctr	\$3,920.00	\$3,357.18
336320	TruckVault Inc.	C-FDEXRN2-11I	Explorer Investigator 2 Dwr	\$3,325.00	\$2,847.61
336320	TruckVault Inc.	C-FDEXRN2-11I-PP	Explorer Investigator 2 Dwr	\$3,325.00	\$2,847.61
336320	TruckVault Inc.	C-FDEXRN2-11I-PP-LT	Explorer Investigator 2 Dwr	\$4,020.00	\$3,442.82
336320	TruckVault Inc.	C-FDEXRN2-11I-PS	Explorer Investigator 2 Dwr	\$3,325.00	\$2,847.61
336320	TruckVault Inc.	C-FDEXRN2-11I-PS-LT	Explorer Investigator 2 Dwr	\$3,920.00	\$3,357.18
336320	TruckVault Inc.	C-FDEXRN2-11I-PS-PP	Explorer Investigator 2 Dwr	\$3,325.00	\$2,847.61
336320	TruckVault Inc.	C-FDEXRN2-11I-PS-PP-LT	Ford Explorer Investigator 2 Dwr, dimensions: 36L x 40W	\$3,920.00	\$3,357.18
336320	TruckVault Inc.	C-FDEXRN2-11I-SA	Explorer Investigator 2 Dwr	\$3,225.00	\$2,761.96
336320	TruckVault Inc.	C-FDEXRN2-11N-C2-HT-ZC8769	Explorer Custom	\$3,825.00	\$3,275.82
336320	TruckVault Inc.	C-FDEXRN2-11N-PPZC11220B	2 Dwr Explorer Special Ops CtrPolice Package; Lift	\$3,725.00	\$3,190.18
336320	TruckVault Inc.	C-FDEXRN2-11N-PP-ZC11220B	2 Dwr Explorer Special Ops CtrPolice Package; Lift	\$3,225.00	\$2,761.96
336320	TruckVault Inc.	C-FDEXRN2-11N-PS-C1-ZC8342	Explorer Cust 2 Dwr	\$2,365.00	\$2,025.44
336320	TruckVault Inc.	C-FDEXRN2-11N-PS-C2-ZC10106	ExplorerInterceptor	\$3,185.00	\$2,727.71
336320	TruckVault Inc.	C-FDEXRN2-11N-PS-C2-ZC8062	Explorer CUST	\$3,345.00	\$2,864.74
336320	TruckVault Inc.	C-FDEXRN2-11N-PS-C2-ZC8626	Explorer CUST	\$4,515.00	\$3,866.75
336320	TruckVault Inc.	C-FDEXRN2-11N-PS-C3-ZC8361	Explorer CUST, C8361	\$2,215.00	\$1,896.98
336320	TruckVault Inc.	C-FDEXRN2-11N-PS-LT-ZC8184	Explorer Cust 2 Dwr	\$4,275.00	\$3,661.21
336320	TruckVault Inc.	C-FDEXRN2-11N-PS-LT-ZC9397	Explorer Custom 2 Drawer w/Lift	\$2,445.00	\$2,093.95
336320	TruckVault Inc.	C-FDEXRN2-11N-PS-PP-ZC8642	Explorer CUST	\$3,605.00	\$3,087.41
336320	TruckVault Inc.	C-FDEXRN2-11N-PS-SA-ZC8129	Explorer Std 2 Dwr	\$2,815.00	\$2,410.83
336320	TruckVault Inc.	C-FDEXRN2-11N-PS-ZC8267	Std 1 dwr bottom Map board dwr top	\$3,045.00	\$2,607.81
336320	TruckVault Inc.	C-FDEXRN2-11N-PS-ZC9437	Explorer Custom	\$3,055.00	\$2,616.37
336320	TruckVault Inc.	C-FDEXRN2-11N-PS-ZC9726	Explorer 2 Dwr Stacked	\$3,295.00	\$2,821.91
336320	TruckVault Inc.	C-FDEXRN2-11N-ZC8745	Explorer CUST	\$3,605.00	\$3,087.41
336320	TruckVault Inc.	C-FDEXRN2-20D-PS-LT	2 Dwr Explorer Special Ops Ctr	\$4,125.00	\$3,532.75
336320	TruckVault Inc.	C-FDEXRN2-20I	Explorer Investigator 2 Dwr	\$3,325.00	\$2,847.61
336320	TruckVault Inc.	C-FDEXRN2-20I-LT	Explorer Investigator 2 Dwr	\$4,125.00	\$3,532.75
336320	TruckVault Inc.	C-FDEXRN2-20I-PP-LT	Explorer Investigator 2 Dwr	\$4,125.00	\$3,532.75
336320	TruckVault Inc.	C-FDEXRN2-20I-PS	Explorer Investigator 2 Dwr	\$3,325.00	\$2,847.61
336320	TruckVault Inc.	C-FDEXRN2-20I-PS-K9	Explorer Investigator 2 Dwr	\$3,225.00	\$2,761.96
336320	TruckVault Inc.	C-FDEXRN2-20I-PS-LR	Explorer Investigator 2 Dwr	\$4,525.00	\$3,875.31
336320	TruckVault Inc.	C-FDEXRN2-20I-PS-LT	Explorer Investigator 2 Dwr	\$4,125.00	\$3,532.75
336320	TruckVault Inc.	C-FDEXRN2-20I-PS-PP	Explorer Investigator 2 DwrPolice Pkg; P-Cage; 2 Dwr	\$3,325.00	\$2,847.61
336320	TruckVault Inc.	C-FDEXRN2-20I-PS-PP-LT	Explorer Investigator 2 Dwr	\$4,125.00	\$3,532.75
336320	TruckVault Inc.	C-FDEXRN2-20N-PS-C1-LT-ZC9575	Explorer CustomC9575	\$3,575.00	\$3,061.71
336320	TruckVault Inc.	C-FDEXRN2-20N-PS-C1-ZC10733	Explorer 2 Dwr CustomC10733	\$2,165.00	\$1,854.16
336320	TruckVault Inc.	C-FDEXRN2-20N-PS-C1-ZC10909	Explorer 2 Dwr CustomC10909	\$2,245.00	\$1,922.67
336320	TruckVault Inc.	C-FDEXRN2-20N-PS-C1-ZC11481A	Explorer 2 Dwr Custom	\$3,655.00	\$3,130.23
336320	TruckVault Inc.	C-FDEXRN2-20N-PS-C1-ZC11650B	Explorer 2 Dwr Custom	\$2,315.00	\$1,982.62
336320	TruckVault Inc.	C-FDEXRN2-20N-PS-C2-ZC10285	Explorer 2 Dwr Custom	\$2,165.00	\$1,854.16
336320	TruckVault Inc.	C-FDEXRN2-20N-PS-C2-ZC10865	Explorer 2 Dwr CustomC10865	\$2,165.00	\$1,854.16
336320	TruckVault Inc.	C-FDEXRN2-20N-PS-C3-ZC11362	Explorer Custom	\$2,215.00	\$1,896.98
336320	TruckVault Inc.	C-FDEXRN2-20N-PS-HG-ZC11000	Explorer CustomC11000	\$2,695.00	\$2,308.06
336320	TruckVault Inc.	C-FDEXRN2-20N-PS-HT-TT-C11254B	Explorer Custom	\$4,500.00	\$3,853.90
336320	TruckVault Inc.	C-FDEXRN2-20N-PS-PP-C3-ZC10409	Explorer Custom CommandC10409	\$3,555.00	\$3,044.58
336320	TruckVault Inc.	C-FDEXRN2-20N-PS-PP-SA-ZC11469	Explorer 2 Drawer Custom	\$3,255.00	\$2,787.66

336320	TruckVault Inc.	C-FDEXRN2-20N-PS-PP-ZC10561	Explorer 2 Dwr Stacked	\$2,445.00	\$2,093.95
336320	TruckVault Inc.	C-FDEXRN2-20N-PS-ZC9726	Explorer 2 Dwr Stacked	\$3,295.00	\$2,821.91
336320	TruckVault Inc.	C-FDEXRN2-20N-TR-HT-C1-ZC10267	Explorer CustomC10267	\$5,365.00	\$4,594.71
336320	TruckVault Inc.	C-FDEXRN3-02D	Ford Explorer Special Ops Ctr, dimensions: 41.5L x 44.5W	\$3,825.00	\$3,275.82
336320	TruckVault Inc.	C-FDEXRN3-02I	Ford Explorer Investigator, dimensions: 40L x 44.5W	\$3,825.00	\$3,275.82
336320	TruckVault Inc.	C-FDEXRN3-02I-HT	Explorer Investigator	\$4,520.00	\$3,871.03
336320	TruckVault Inc.	C-FDEXRN3-02I-PP	Ford Explorer Investigator, dimensions: 37L x 44.5W	\$3,825.00	\$3,275.82
336320	TruckVault Inc.	C-FDEXRN3-02R	Ford Explorer Field Ranger, dimensions: 40L x 44.5W	\$3,245.00	\$2,779.09
336320	TruckVault Inc.	C-FDEXRN3-06D	Ford Explorer Special Ops Ctr, dimensions: 39L x 44.5W	\$3,825.00	\$3,275.82
336320	TruckVault Inc.	C-FDEXRN3-06D-PT	Ford Explorer Special Ops Ctr, dimensions: 39L x 44.5W	\$4,520.00	\$3,871.03
336320	TruckVault Inc.	C-FDEXRN3-06I	Ford Explorer Investigator, dimensions: 38.5L x 44.5W	\$3,825.00	\$3,275.82
336320	TruckVault Inc.	C-FDEXRN3-06I-PP	Ford Explorer Investigator, dimensions: 35.5L x 44.5W	\$3,725.00	\$3,190.18
336320	TruckVault Inc.	C-FDEXRN3-06I-PT	Ford Explorer Investigator, dimensions: 38.5L x 44.5W	\$4,520.00	\$3,871.03
336320	TruckVault Inc.	C-FDEXRN3-06R	Ford Explorer Field Ranger, dimensions: 40L x 44.5W	\$3,245.00	\$2,779.09
336320	TruckVault Inc.	C-FDEXRN3-06R-PP	Ford Explorer Field Ranger, dimensions: 35.5L x 44.5W	\$3,045.00	\$2,607.81
336320	TruckVault Inc.	C-FDEXRN3-06R-PT	Ford Explorer Field Ranger, dimensions: 37.5L x 44.5W	\$3,940.00	\$3,374.31
336320	TruckVault Inc.	C-FDEXRN3-11D	Ford Explorer Special Ops Ctr, dimensions: 0L x 0W	\$3,825.00	\$3,275.82
336320	TruckVault Inc.	C-FDEXRN3-11D-HT	Explorer Special Ops Ctr	\$4,520.00	\$3,871.03
336320	TruckVault Inc.	C-FDEXRN3-11D-PP-ZC9661	Explorer Special Ops Ctr 35"L	\$3,725.00	\$3,190.18
336320	TruckVault Inc.	C-FDEXRN3-11D-PS	Ford Explorer Special Ops Ctr, dimensions: 43L x 40W	\$3,825.00	\$3,275.82
336320	TruckVault Inc.	C-FDEXRN3-11D-PS-HT	Explorer Special Ops Ctr	\$4,520.00	\$3,871.03
336320	TruckVault Inc.	C-FDEXRN3-11D-PS-LT	Ford Explorer Special Ops Ctr, dimensions: 41L x 40W	\$4,420.00	\$3,785.39
336320	TruckVault Inc.	C-FDEXRN3-11D-PS-P7-PT	Ford Explorer Special Ops Ctr, dimensions: 35L x 40W	\$4,420.00	\$3,785.39
336320	TruckVault Inc.	C-FDEXRN3-11D-PS-PP	Ford Explorer Special Ops Ctr, dimensions: 40L x 40W	\$3,825.00	\$3,275.82
336320	TruckVault Inc.	C-FDEXRN3-11D-PS-PP-LT	Ford Explorer Special Ops Ctr, dimensions: 36L x 40W	\$4,420.00	\$3,785.39
336320	TruckVault Inc.	C-FDEXRN3-11D-PS-PP-PT	Ford Explorer Special Ops Ctr, dimensions: 39L x 40W	\$4,520.00	\$3,871.03
336320	TruckVault Inc.	C-FDEXRN3-11D-PS-PP-SA	Ford Explorer Special Ops Ctr, dimensions: 43L x 40W	\$3,725.00	\$3,190.18
336320	TruckVault Inc.	C-FDEXRN3-11D-PS-PT	Ford Explorer Special Ops Ctr, dimensions: 42L x 40W	\$4,520.00	\$3,871.03
336320	TruckVault Inc.	C-FDEXRN3-11D-PS-PT-SA	Ford Explorer Special Ops Ctr, dimensions: 43L x 40W	\$4,520.00	\$3,871.03
336320	TruckVault Inc.	C-FDEXRN3-11D-PS-SA	Ford Explorer Special Ops Ctr, dimensions: 43L x 40W	\$3,825.00	\$3,275.82
336320	TruckVault Inc.	C-FDEXRN3-11D-PT	Ford Explorer Special Ops Ctr, dimensions: 0L x 0W	\$4,520.00	\$3,871.03
336320	TruckVault Inc.	C-FDEXRN3-11D-TR	Ford Explorer Special Ops Ctr, dimensions: 0L x 0W	\$3,725.00	\$3,190.18
336320	TruckVault Inc.	C-FDEXRN3-11I	Ford Explorer Investigator, dimensions: 41L x 40W	\$3,825.00	\$3,275.82
336320	TruckVault Inc.	C-FDEXRN3-11I-HT-LT	Explorer Investigator	\$5,215.00	\$4,466.25
336320	TruckVault Inc.	C-FDEXRN3-11I-PP	Ford Explorer Investigator, dimensions: 38L x 40W	\$3,825.00	\$3,275.82
336320	TruckVault Inc.	C-FDEXRN3-11I-PS	Ford Explorer Investigator, dimensions: 41L x 40W	\$3,825.00	\$3,275.82
336320	TruckVault Inc.	C-FDEXRN3-11I-PS-HT-LT	Explorer Investigator	\$5,115.00	\$4,380.60
336320	TruckVault Inc.	C-FDEXRN3-11I-PS-LT	Ford Explorer Investigator, dimensions: 41L x 40W	\$4,420.00	\$3,785.39
336320	TruckVault Inc.	C-FDEXRN3-11I-PS-P7	Ford Explorer Investigator, dimensions: 34L x 40W	\$3,725.00	\$3,190.18
336320	TruckVault Inc.	C-FDEXRN3-11I-PS-PP	Ford Explorer Investigator, dimensions: 38L x 40W	\$3,825.00	\$3,275.82
336320	TruckVault Inc.	C-FDEXRN3-11I-PS-PP-HT-LT	Explorer Investigator	\$5,115.00	\$4,380.60
336320	TruckVault Inc.	C-FDEXRN3-11I-PS-PP-LT	Ford Explorer Investigator, dimensions: 36L x 40W	\$4,420.00	\$3,785.39
336320	TruckVault Inc.	C-FDEXRN3-11I-PS-PP-LT-ZC9601	Explorer Investigator 34"L	\$4,405.00	\$3,772.54
336320	TruckVault Inc.	C-FDEXRN3-11I-PS-PP-PT	Ford Explorer Investigator, dimensions: 40L x 40W	\$4,520.00	\$3,871.03
336320	TruckVault Inc.	C-FDEXRN3-11I-PS-PP-PT-LT	Explorer Investigator	\$5,115.00	\$4,380.60
336320	TruckVault Inc.	C-FDEXRN3-11I-PS-PP-SA	Ford Explorer Investigator, dimensions: 25L x 40W	\$3,725.00	\$3,190.18
336320	TruckVault Inc.	C-FDEXRN3-11I-PS-PT	Ford Explorer Investigator, dimensions: 40L x 40W	\$4,520.00	\$3,871.03
336320	TruckVault Inc.	C-FDEXRN3-11I-PS-PT-LT	Ford Explorer Investigator, dimensions: 41L x 40W	\$5,115.00	\$4,380.60
336320	TruckVault Inc.	C-FDEXRN3-11I-PS-SA	Ford Explorer Investigator, dimensions: 38L x 40W	\$3,825.00	\$3,275.82
336320	TruckVault Inc.	C-FDEXRN3-11I-PT	Ford Explorer Investigator, dimensions: 40L x 40W	\$4,520.00	\$3,871.03
336320	TruckVault Inc.	C-FDEXRN3-11I-PT-LT	Explorer Investigator	\$5,215.00	\$4,466.25
336320	TruckVault Inc.	C-FDEXRN3-11I-SA	Ford Explorer Investigator, dimensions: 38L x 40W	\$3,825.00	\$3,275.82
336320	TruckVault Inc.	C-FDEXRN3-11I-TR	Ford Explorer Investigator, dimensions: 32L x 40W	\$3,725.00	\$3,190.18
336320	TruckVault Inc.	C-FDEXRN3-11N-C1-ZC9084	Explorer Custom	\$3,405.00	\$2,916.12
336320	TruckVault Inc.	C-FDEXRN3-11N-PS-C3-ZC9847	Explorer CustomC9847	\$5,585.00	\$4,783.12
336320	TruckVault Inc.	C-FDEXRN3-11N-PS-LT-ZC9078	Explorer Custom	\$3,755.00	\$3,215.87
336320	TruckVault Inc.	C-FDEXRN3-11N-PS-PP-LT-ZC8692	Explorer CUST	\$4,405.00	\$3,772.54
336320	TruckVault Inc.	C-FDEXRN3-11N-PS-PT	Ford Explorer CUST Command Center, dimensions: 38L x 40W	\$4,320.00	\$3,699.75
336320	TruckVault Inc.	C-FDEXRN3-11N-PS-PT-ZC8483	Explorer PPV CUST CC	\$4,705.00	\$4,029.47
336320	TruckVault Inc.	C-FDEXRN3-11N-PS-ZC8941	Explorer Custom	\$4,055.00	\$3,472.80
336320	TruckVault Inc.	C-FDEXRN3-11N-TR-LT-ZC9865	Explorer Custom	\$4,175.00	\$3,575.57
336320	TruckVault Inc.	C-FDEXRN3-11N-TR-ZC8766	Explorer Custom	\$3,705.00	\$3,173.05
336320	TruckVault Inc.	C-FDEXRN3-11N-ZC10461	Explorer CustomC10461	\$3,985.00	\$3,412.85
336320	TruckVault Inc.	C-FDEXRN3-11N-ZC8338	Explorer CUST CC	\$4,065.00	\$3,481.36
336320	TruckVault Inc.	C-FDEXRN3-11R	Ford Explorer Field Ranger, dimensions: 41L x 40W	\$3,245.00	\$2,779.09
336320	TruckVault Inc.	C-FDEXRN3-11R-LT	Ford Explorer Field Ranger, dimensions: 41L x 40W	\$3,940.00	\$3,374.31

336320	TruckVault Inc.	C-FDEXRN3-11R-PP	Ford Explorer Field Ranger, dimensions: 38L x 40W	\$3,245.00	\$2,779.09
336320	TruckVault Inc.	C-FDEXRN3-11R-PS	Ford Explorer Field Ranger, dimensions: 41L x 40W	\$3,245.00	\$2,779.09
336320	TruckVault Inc.	C-FDEXRN3-11R-PS-HT	Ford Explorer Field Ranger, dimensions: 39L x 40W	\$3,940.00	\$3,374.31
336320	TruckVault Inc.	C-FDEXRN3-11R-PS-LT	Ford Explorer Field Ranger, dimensions: 41L x 40W	\$3,840.00	\$3,288.66
336320	TruckVault Inc.	C-FDEXRN3-11R-PS-PP	Ford Explorer Field Ranger, dimensions: 38L x 40W	\$3,245.00	\$2,779.09
336320	TruckVault Inc.	C-FDEXRN3-11R-PS-PP-LT	Ford Explorer Field Ranger, dimensions: 36L x 40W	\$3,840.00	\$3,288.66
336320	TruckVault Inc.	C-FDEXRN3-11R-PS-PT	Ford Explorer Field Ranger, dimensions: 40L x 40W	\$3,940.00	\$3,374.31
336320	TruckVault Inc.	C-FDEXRN3-11R-PT	Ford Explorer Field Ranger, dimensions: 37.5L x 44.5W	\$3,940.00	\$3,374.31
336320	TruckVault Inc.	C-FDEXRN3-20D-PS	Explorer Special Ops Ctr	\$3,825.00	\$3,275.82
336320	TruckVault Inc.	C-FDEXRN3-20D-PS-HT	Explorer Special Ops Ctr	\$4,520.00	\$3,871.03
336320	TruckVault Inc.	C-FDEXRN3-20D-PS-LR-ZC11264	Explorer Special Ops Ctr Radio Lift	\$4,165.00	\$3,567.00
336320	TruckVault Inc.	C-FDEXRN3-20D-PS-LT	Explorer Special Ops Ctr	\$4,625.00	\$3,960.96
336320	TruckVault Inc.	C-FDEXRN3-20D-PS-PP-LT	Explorer Special Ops CtrPrisoner Cage; Lift	\$4,625.00	\$3,960.96
336320	TruckVault Inc.	C-FDEXRN3-20D-PS-PT	Explorer Special Ops Ctr	\$4,520.00	\$3,871.03
336320	TruckVault Inc.	C-FDEXRN3-20D-PS-ZC11263	Explorer Special Ops CtrC11263	\$4,455.00	\$3,815.37
336320	TruckVault Inc.	C-FDEXRN3-20I	Explorer Investigator	\$3,825.00	\$3,275.82
336320	TruckVault Inc.	C-FDEXRN3-20I-HT-LT	Explorer InvestigatorCivilian Lift, HD Table	\$5,320.00	\$4,556.17
336320	TruckVault Inc.	C-FDEXRN3-20I-PP-LR	Explorer Investigator	\$3,825.00	\$3,275.82
336320	TruckVault Inc.	C-FDEXRN3-20I-PP-LT	Explorer Investigator	\$4,625.00	\$3,960.96
336320	TruckVault Inc.	C-FDEXRN3-20I-PS	Explorer Investigator	\$3,825.00	\$3,275.82
336320	TruckVault Inc.	C-FDEXRN3-20I-PS-HT	Explorer InvestigatorPolice Package No 3rd Row Seat; Heavy Duty Table	\$4,520.00	\$3,871.03
336320	TruckVault Inc.	C-FDEXRN3-20I-PS-HT-LT	Explorer Investigator	\$5,320.00	\$4,556.17
336320	TruckVault Inc.	C-FDEXRN3-20I-PS-K9	Explorer InvestigatorPolice Package; Prisoner Cage - 10" Short for K9	\$3,555.00	\$3,044.58
336320	TruckVault Inc.	C-FDEXRN3-20I-PS-LT	Explorer Investigator	\$4,625.00	\$3,960.96
336320	TruckVault Inc.	C-FDEXRN3-20I-PS-PP	Explorer InvestigatorPolice Package; Prisoner Cage; No 3rd Row Seat	\$3,825.00	\$3,275.82
336320	TruckVault Inc.	C-FDEXRN3-20I-PS-PP-HT-LT	Explorer Investigator	\$5,320.00	\$4,556.17
336320	TruckVault Inc.	C-FDEXRN3-20I-PS-PP-LT	Explorer Investigator	\$4,625.00	\$3,960.96
336320	TruckVault Inc.	C-FDEXRN3-20I-PS-PT-LT	Explorer Investigator	\$5,320.00	\$4,556.17
336320	TruckVault Inc.	C-FDEXRN3-20N-HT-ZC9957	Explorer 3 drawer Stacked	\$4,585.00	\$3,926.70
336320	TruckVault Inc.	C-FDEXRN3-20N-LT-ZC10698	Explorer Custom	\$4,115.00	\$3,524.18
336320	TruckVault Inc.	C-FDEXRN3-20N-PS-C1-LT-Z2	Explorer CUST	\$4,515.00	\$3,866.75
336320	TruckVault Inc.	C-FDEXRN3-20N-PS-C2-ZC10154	Explorer CustomC10154	\$3,455.00	\$2,958.94
336320	TruckVault Inc.	C-FDEXRN3-20N-PS-HT-ZC9957	Explorer 3 drawer Stacked	\$4,245.00	\$3,635.52
336320	TruckVault Inc.	C-FDEXRN3-20N-PS-LR-ZC11264	Explorer CustomC11264	\$3,535.00	\$3,027.46
336320	TruckVault Inc.	C-FDEXRN3-20N-PS-LT-ZC9867	Explorer Custom	\$3,755.00	\$3,215.87
336320	TruckVault Inc.	C-FDEXRN3-20N-PS-PP-HT-ZC10234	Explorer CustomC10234	\$6,375.00	\$5,459.70
336320	TruckVault Inc.	C-FDEXRN3-20N-PS-PP-ZC10112	Explorer CustomC10112	\$3,985.00	\$3,412.85
336320	TruckVault Inc.	C-FDEXRN3-20N-PS-PT-LT-Z2	Explorer CUST	\$4,635.00	\$3,969.52
336320	TruckVault Inc.	C-FDEXRN3-20N-TR-LT-ZC9865	Explorer Custom	\$4,175.00	\$3,575.57
336320	TruckVault Inc.	C-FDEXRN3-20N-ZC10020	Explorer Custom	\$4,135.00	\$3,541.31
336320	TruckVault Inc.	C-FDEXRN3-20N-ZC9859	Explorer Custom	\$4,465.00	\$3,823.93
336320	TruckVault Inc.	C-FDEXRN3-20R	Explorer Field Ranger	\$3,245.00	\$2,779.09
336320	TruckVault Inc.	C-FDEXRN3-20R-LT	Explorer Field Ranger	\$4,045.00	\$3,464.23
336320	TruckVault Inc.	C-FDEXRN3-20R-PS	Explorer Field Ranger	\$3,245.00	\$2,779.09
336320	TruckVault Inc.	C-FDEXRN3-20R-PS-LT	Explorer Field Ranger	\$4,045.00	\$3,464.23
336320	TruckVault Inc.	C-FDEXRN3-20R-PS-PP	Explorer Field Ranger	\$3,245.00	\$2,779.09
336320	TruckVault Inc.	C-FDEXRN3-20R-PS-PP-LT	Explorer Field Ranger	\$4,045.00	\$3,464.23
336320	TruckVault Inc.	C-FDEXRN4-11N-PS-ZC11311	Explorer Custom	\$2,965.00	\$2,539.29
336320	TruckVault Inc.	C-FDEXRN4-11N-PS-ZC6030	Explorer Cust 4 Dwr	\$2,965.00	\$2,539.29
336320	TruckVault Inc.	C-FDEXRN4-11N-PS-ZC8325	Explorer CUST	\$3,265.00	\$2,796.22
336320	TruckVault Inc.	C-FDEXRN4-11N-PS-ZC8640	Explorer CUST	\$4,005.00	\$3,429.97
336320	TruckVault Inc.	C-FDEXRN4-11N-ZC10434	Explorer CustomFor Civilian and Interceptor; C10443	\$3,375.00	\$2,890.43
336320	TruckVault Inc.	C-FDEXRN4-11N-ZC9316	Explorer Custom	\$5,295.00	\$4,534.76
336320	TruckVault Inc.	C-FDEXRN4-11N-ZC9354	Mag bottom, File dwr, 1/2 W map	\$4,525.00	\$3,875.31
336320	TruckVault Inc.	C-FDEXRN4-11P	Explorer Captain CC	\$3,795.00	\$3,250.13
336320	TruckVault Inc.	C-FDEXRN4-11P-PS	Ford Explorer Captain CC, dimensions: 30.125L x 40W	\$3,795.00	\$3,250.13
336320	TruckVault Inc.	C-FDEXRN4-11P-PS-HT	Explorer Captain CC	\$4,490.00	\$3,845.34
336320	TruckVault Inc.	C-FDEXRN4-11P-PS-PP	Ford Explorer Captain CC, dimensions: 30.125L x 40W	\$3,795.00	\$3,250.13
336320	TruckVault Inc.	C-FDEXRN4-11P-PS-PT	Explorer Captain CC	\$4,490.00	\$3,845.34
336320	TruckVault Inc.	C-FDEXRN4-11P-PT	Explorer Captain CC	\$4,694.00	\$4,020.05
336320	TruckVault Inc.	C-FDEXRN4-11P-TR	Ford Explorer Captain CC, dimensions: 30.125L x 40W	\$3,795.00	\$3,250.13
336320	TruckVault Inc.	C-FDEXRN4-20N-PS-HT-C2-ZC11208	Explorer Custom	\$3,705.00	\$3,173.05
336320	TruckVault Inc.	C-FDEXRN4-20N-PS-LT-ZC10516	Explorer CustomC10516	\$4,965.00	\$4,252.14
336320	TruckVault Inc.	C-FDEXRN4-20N-PS-PP-ZC10399	Explorer Custom	\$3,705.00	\$3,173.05

336320	TruckVault Inc.	C-FDEXRN4-20N-PS-PP-ZC10721	Explorer CustomC10721	\$4,165.00	\$3,567.00
336320	TruckVault Inc.	C-FDEXRN4-20N-PS-PT-ZC10915A	Explorer CustomC10915A	\$4,665.00	\$3,995.21
336320	TruckVault Inc.	C-FDEXRN4-20N-PS-ZC10322	ExplorerPolice Package No 3rd Row Seat	\$3,705.00	\$3,173.05
336320	TruckVault Inc.	C-FDEXRN4-20N-PS-ZC10399	Explorer CustomC10399	\$3,705.00	\$3,173.05
336320	TruckVault Inc.	C-FDEXRN4-20N-PS-ZC10721	Explorer CustomC10721	\$4,165.00	\$3,567.00
336320	TruckVault Inc.	C-FDEXRN4-20P-PS	Explorer Captain CC	\$3,795.00	\$3,250.13
336320	TruckVault Inc.	C-FDEXRN4-20P-PS-HT	Explorer Captain CC, HD TablePolice Package No 3rd Row Seat	\$4,490.00	\$3,845.34
336320	TruckVault Inc.	C-FDEXRN5-11C	Ford Explorer Chief LX CC, dimensions: 30.125L x 40W	\$4,545.00	\$3,892.44
336320	TruckVault Inc.	C-FDEXRN5-11C-PS	Ford Explorer Chief LX CC, dimensions: 30.125L x 40W	\$4,545.00	\$3,892.44
336320	TruckVault Inc.	C-FDEXRN5-11C-PS-PT	Ford Explorer Chief LX CC, dimensions: 30.125L x 40W	\$5,240.00	\$4,487.66
336320	TruckVault Inc.	C-FDEXRN5-11C-PT	Ford Explorer Chief LX CC, dimensions: 30.125L x 40W	\$5,240.00	\$4,487.66
336320	TruckVault Inc.	C-FDEXRN5-11C-TR	Ford Explorer Chief LX CC, dimensions: 30.125L x 40W	\$4,545.00	\$3,892.44
336320	TruckVault Inc.	C-FDEXRN5-11T	Ford Explorer TAC CC, dimensions: 30.125L x 40W	\$4,545.00	\$3,892.44
336320	TruckVault Inc.	C-FDEXRN5-11T-PS	Ford Explorer TAC CC, dimensions: 30.125L x 40W	\$4,545.00	\$3,892.44
336320	TruckVault Inc.	C-FDEXRN5-20C-PS	Explorer Chief LX CC	\$4,545.00	\$3,892.44
336320	TruckVault Inc.	C-FDEXRN5-20T	Explorer TAC CCCivilian	\$4,545.00	\$3,892.44
336320	TruckVault Inc.	C-FDEXRN5-20T-PS	Explorer TAC CC	\$4,545.00	\$3,892.44
336320	TruckVault Inc.	C-FDEXRN6-06C	Explorer Chief LX CC	\$4,845.00	\$4,149.37
336320	TruckVault Inc.	C-FDEXRN6-11C	Explorer Chief LX CC	\$4,845.00	\$4,149.37
336320	TruckVault Inc.	C-FDEXRSO-20N-PS-C1-LT-ZC9881	Explorer Custom	\$4,555.00	\$3,901.01
336320	TruckVault Inc.	C-FDEXRU1-11N-PS-C2-ZC9098	Explorer CustomC9098	\$2,035.00	\$1,742.82
336320	TruckVault Inc.	C-FDEXRU1-11N-PS-SA-C2-ZC9098	Explorer CustomC9098	\$2,035.00	\$1,742.82
336320	TruckVault Inc.	C-FDFLXN5-09C	Ford Flex Chief CC, dimensions: 31.125L x 40W	\$4,545.00	\$3,892.44
336320	TruckVault Inc.	C-FDFSEM2-04L-VP	F-150 Pickup Surveyor	\$4,325.00	\$3,704.03
336320	TruckVault Inc.	C-FDFSEM2-04S-PC-VP	F-150 Pickup Surveyor	\$3,905.00	\$3,344.33
336320	TruckVault Inc.	C-FDFSEM2-04S-VP	Ford F-Series Pickup Surveyor, dimensions: 73L x 48W	\$4,115.00	\$3,524.18
336320	TruckVault Inc.	C-FDFSEM2-12L-P5-VP	Ford F-Series Pickup Surveyor, dimensions: 96L x 48W	\$4,325.00	\$3,704.03
336320	TruckVault Inc.	C-FDFSEM2-15S-PC-VP	F-Series Pickup Surveyor	\$3,905.00	\$3,344.33
336320	TruckVault Inc.	C-FDFSEM2-15S-VP	F-Series Pickup Surveyor	\$4,115.00	\$3,524.18
336320	TruckVault Inc.	C-FDFSEM2-17L-P5-VP	F-Series Pickup Surveyor	\$4,325.00	\$3,704.03
336320	TruckVault Inc.	C-FDFSEM2-17S-P5-VP	F-Series Pickup Surveyor	\$4,115.00	\$3,524.18
336320	TruckVault Inc.	C-FDFSEM2-17S-P5-VP-PW	F-Series Pickup Surveyor All-WeatherF250 & 350, 2 Dwr	\$6,045.00	\$5,177.08
336320	TruckVault Inc.	C-FDFSEN1-17S-P5-C3-ZC10393	F-Series Pickup CustomC10393	\$1,145.00	\$980.60
336320	TruckVault Inc.	C-FDFSEN1-15S-PC-C2-HT-ZC10439	F-Series Pickup CustomC10439	\$3,475.00	\$2,976.07
336320	TruckVault Inc.	C-FDFSEN1-17S-P5-C1-ZC9210	F-Series Pickup Custom	\$1,975.00	\$1,691.44
336320	TruckVault Inc.	C-FDFSEN1-17S-P5-C2-ZC9800	F-Series Pickup Custom	\$2,255.00	\$1,931.23
336320	TruckVault Inc.	C-FDFSEN2-15S-PC-C1-PW-ZC8505	F-150 Cust AW	\$6,425.00	\$5,502.52
336320	TruckVault Inc.	C-FDFSEN2-15S-PC-C6-ZC9102	F-Series Pickup Custom	\$7,155.00	\$6,127.71
336320	TruckVault Inc.	C-FDFSEN2-15S-PC-HD-ZC10534	F-Series Pickup CustomC10534	\$3,475.00	\$2,976.07
336320	TruckVault Inc.	C-FDFSEN2-15S-PC-HN-PW-ZC11680	F-Series Pickup Custom	\$3,545.00	\$3,036.02
336320	TruckVault Inc.	C-FDFSEN2-15S-PC-HN-PW-ZC9883	F-Series Pickup Custom	\$5,425.00	\$4,646.10
336320	TruckVault Inc.	C-FDFSEN2-15S-PC-PW-ZC10083	F-Series Pickup CustomC10083	\$4,595.00	\$3,935.26
336320	TruckVault Inc.	C-FDFSEN2-15S-PC-PW-ZC11340A	F-Series Pickup CustomC11340A	\$3,585.00	\$3,070.28
336320	TruckVault Inc.	C-FDFSEN2-15S-ZC10129	F-Series CustomC10129	\$3,055.00	\$2,616.37
336320	TruckVault Inc.	C-FDFSEN2-17L-HT-C6-ZC9402	F-Series Pickup Custom	\$8,555.00	\$7,326.70
336320	TruckVault Inc.	C-FDFSEN2-17N-P5-C2-ZC8351	F-Series Pickup Custom	\$3,905.00	\$3,344.33
336320	TruckVault Inc.	C-FDFSEN2-17S-P5-C1-ZC10933A	F-Series Pickup CustomC10933A	\$3,485.00	\$2,984.63
336320	TruckVault Inc.	C-FDFSEN2-17S-P5-C1-ZC11072FG	F-Series Pickup Custom	\$3,050.00	\$2,612.09
336320	TruckVault Inc.	C-FDFSEN2-17S-P5-C4-ZC9593	F-Series Pickup Custom	\$4,635.00	\$3,969.52
336320	TruckVault Inc.	C-FDFSEN2-17S-P5-C5-ZC10162	F-Series CustomC10162	\$3,695.00	\$3,164.48
336320	TruckVault Inc.	C-FDFSEN2-17S-P5-HP-ZC11014A	F-Series CustomC11014A	\$3,815.00	\$3,267.25
336320	TruckVault Inc.	C-FDFSEN2-17S-P5-ZC10004	F-Series CustomC10004	\$2,755.00	\$2,359.45
336320	TruckVault Inc.	C-FDFSEN2-17S-P5-ZC8791	2 stacked 1/2 Width No wings	\$2,245.00	\$1,922.67
336320	TruckVault Inc.	C-FDFSEN2-17S-P5-ZC9458	F-Series Pickup CUST	\$2,885.00	\$2,470.78
336320	TruckVault Inc.	C-FDFSEN3-04R-PC	Ford F-Series Pickup Field Ranger, dimensions: 64L x 53W	\$3,995.00	\$3,421.41
336320	TruckVault Inc.	C-FDFSEN3-04S-BH	Ford F-Series Pickup BowHunter, dimensions: 75L x 48W	\$4,195.00	\$3,592.70
336320	TruckVault Inc.	C-FDFSEN3-04S-BH-PW	F-Series Pickup BowHunter	\$4,845.00	\$4,149.37
336320	TruckVault Inc.	C-FDFSEN3-04S-CR-PW	F-150 AW Field Ranger	\$5,195.00	\$4,449.12
336320	TruckVault Inc.	C-FDFSEN3-04S-PC-BH	Ford F-Series Pickup BowHunter, dimensions: 64L x 53W	\$3,995.00	\$3,421.41
336320	TruckVault Inc.	C-FDFSEN3-04S-PC-BH-PW	F-Series Pickup BowHunter	\$4,085.00	\$3,498.49
336320	TruckVault Inc.	C-FDFSEN3-04S-PC-CR-PW	F-150 Pickup Field Ranger	\$4,895.00	\$4,192.19
336320	TruckVault Inc.	C-FDFSEN3-04S-PC-VP	Ford F-Series Pickup Surveyor, dimensions: 0L x 0W	\$3,905.00	\$3,344.33
336320	TruckVault Inc.	C-FDFSEN3-09S-PC-PF-BH-PW	F-Series Pickup	\$4,545.00	\$3,892.44
336320	TruckVault Inc.	C-FDFSEN3-12L-P5-CR	Ford F-Series Pickup Field Ranger, dimensions: 94.5L x 48W	\$4,745.00	\$4,063.73
336320	TruckVault Inc.	C-FDFSEN3-12S-P5-BH-PW	Ford F-Series Pickup BowHunter, dimensions: 78L x 48W	\$4,845.00	\$4,149.37
336320	TruckVault Inc.	C-FDFSEN3-12S-P5-CR	Ford F-Series Pickup Field Ranger, dimensions: 78L x 48W	\$4,545.00	\$3,892.44

336320	TruckVault Inc.	C-FDFSEN3-12S-P5-CR-PW	F-250 AW Field RangerShort Bed F250 AW Field Ranger	\$2,325.00	\$1,991.18
336320	TruckVault Inc.	C-FDFSEN3-15L-BH	F-Series Pickup BowHunter8'Bed	\$4,395.00	\$3,763.98
336320	TruckVault Inc.	C-FDFSEN3-15L-CR-PW	F-150 AW Field RangerLong Bed F150 AW Field Ranger	\$5,495.00	\$4,706.05
336320	TruckVault Inc.	C-FDFSEN3-15S-BH-PW	F-150 Pickup BowHunter	\$4,845.00	\$4,149.37
336320	TruckVault Inc.	C-FDFSEN3-15S-CR	F-Series Pickup Field Ranger	\$4,545.00	\$3,892.44
336320	TruckVault Inc.	C-FDFSEN3-15S-CR-PW	F-150 AW Field Ranger	\$5,195.00	\$4,449.12
336320	TruckVault Inc.	C-FDFSEN3-15S-PC-BH	Ford F-Series Pickup BowHunter, dimensions: 63L x 48W	\$3,995.00	\$3,421.41
336320	TruckVault Inc.	C-FDFSEN3-15S-PC-BH-PW	Ford F-Series Pickup, dimensions: 63.5L x 53W	\$4,545.00	\$3,892.44
336320	TruckVault Inc.	C-FDFSEN3-15S-PC-CR	F-Series Pickup Field Ranger	\$4,345.00	\$3,721.16
336320	TruckVault Inc.	C-FDFSEN3-15S-PC-CR-HT-PW	F-150 Pickup Field Ranger	\$5,590.00	\$4,787.41
336320	TruckVault Inc.	C-FDFSEN3-15S-PC-CR-PW	F-150 Pickup Field Ranger	\$4,895.00	\$4,192.19
336320	TruckVault Inc.	C-FDFSEN3-15S-PC-CR-PW-ZC8376	F-150 Pickup Cust Field Ranger	\$4,975.00	\$4,260.71
336320	TruckVault Inc.	C-FDFSEN3-15S-PC-CR-ZC9261	F-Series Pickup CustomC9261; 5' 6" Bed	\$3,485.00	\$2,984.63
336320	TruckVault Inc.	C-FDFSEN3-15S-PC-PW-ZC11203	F-150 Pickup CustomC11203	\$4,895.00	\$4,192.19
336320	TruckVault Inc.	C-FDFSEN3-15S-PC-PW-ZC8504	F-150 Pickup Cust	\$4,855.00	\$4,157.93
336320	TruckVault Inc.	C-FDFSEN3-15S-PT-CR	F-Series Pickup Field Ranger	\$5,240.00	\$4,487.66
336320	TruckVault Inc.	C-FDFSEN3-15S-PW-ZC8547	F-Series Pickup Custom	\$5,705.00	\$4,885.89
336320	TruckVault Inc.	C-FDFSEN3-17L-P5-CR	F-Series Pickup Field Ranger	\$4,745.00	\$4,063.73
336320	TruckVault Inc.	C-FDFSEN3-17L-P5-CR-PW	F-Series Pickup AW Field Ranger	\$5,495.00	\$4,706.05
336320	TruckVault Inc.	C-FDFSEN3-17S-P5-BH-PW	F-Series Pickup BowHunter	\$4,845.00	\$4,149.37
336320	TruckVault Inc.	C-FDFSEN3-17S-P5-BH-PW-ZC9060	F-Series Pickup Custom	\$5,565.00	\$4,765.99
336320	TruckVault Inc.	C-FDFSEN3-17S-P5-C3-ZC9479	F-Series Pickup Custom	\$5,565.00	\$4,765.99
336320	TruckVault Inc.	C-FDFSEN3-17S-P5-C3-ZC9763	F-Series Pickup Custom	\$5,565.00	\$4,765.99
336320	TruckVault Inc.	C-FDFSEN3-17S-P5-C4-ZC10689A	F-Series Pickup CustomC10689A	\$5,005.00	\$4,286.40
336320	TruckVault Inc.	C-FDFSEN3-17S-P5-C4-ZC10689B	F-Series Pickup CustomC10689B	\$5,005.00	\$4,286.40
336320	TruckVault Inc.	C-FDFSEN3-17S-P5-CR	F-Series Pickup Field Ranger	\$4,545.00	\$3,892.44
336320	TruckVault Inc.	C-FDFSEN3-17S-P5-CR-PW	F-250 AW Field Ranger	\$5,195.00	\$4,449.12
336320	TruckVault Inc.	C-FDFSEN3-17S-P5-PW-ZC9305	F-Series Pickup Custom	\$5,995.00	\$5,134.26
336320	TruckVault Inc.	C-FDFSEN3-17S-P5-VP-ZC9163	F-Series Pickup Custom Surveyor	\$4,975.00	\$4,260.71
336320	TruckVault Inc.	C-FDFSEN3-17S-P5-ZC8353	F-Series Pickup CUST	\$4,725.00	\$4,046.60
336320	TruckVault Inc.	C-FDFSEN3-97L-P5-BH-PW	Ford F-Series Pickup BowHunter, dimensions: 94L x 49.5W	\$5,145.00	\$4,406.30
336320	TruckVault Inc.	C-FDFSEN3-97S-CR-PW	F-150 AW Field Ranger	\$5,195.00	\$4,449.12
336320	TruckVault Inc.	C-FDFSEN4-04S-PC-VP	F-150 Pickup Surveyor	\$5,585.00	\$4,783.12
336320	TruckVault Inc.	C-FDFSEN4-04S-VP	F-150 Pickup Surveyor	\$5,895.00	\$5,048.61
336320	TruckVault Inc.	C-FDFSEN4-15N-ZC8820	F-Series Pickup Cust 4 Dwr	\$3,415.00	\$2,924.69
336320	TruckVault Inc.	C-FDFSEN4-15S-PC-PW-ZC11804B	F-Series Pickup Custom	\$6,500.00	\$5,566.75
336320	TruckVault Inc.	C-FDFSEN4-17S-P5-C5-ZC9746	F-Series Pickup CustomC9746	\$6,535.00	\$5,596.73
336320	TruckVault Inc.	C-FDFSEN4-17S-P5-ZC8044	F-Series Pickup Custom	\$5,605.00	\$4,800.25
336320	TruckVault Inc.	C-FDFSEN4-17S-ZC9394	F-Series Pickup Custom	\$3,785.00	\$3,241.56
336320	TruckVault Inc.	C-FDFSEN5-04C	Ford F-Series Pickup Chief LX CC, dimensions: 30.125L x 48W	\$4,545.00	\$3,892.44
336320	TruckVault Inc.	C-FDFSEN5-04C-PT-BS	Ford F-Series Pickup Chief LX CC, dimensions: 30.125L x 47.5W	\$5,240.00	\$4,487.66
336320	TruckVault Inc.	C-FDFSEN5-15S-PC-TT-ZC7981	F-150 Pickup Cust	\$6,305.00	\$5,399.75
336320	TruckVault Inc.	C-FDFSEN5-15S-PC-ZC9533	F-Series Pickup Custom	\$6,365.00	\$5,451.13
336320	TruckVault Inc.	C-FDFSEN5-17N-P5-C1-Z8047	F-Series CustomC8047; Mounts on Slide	\$4,285.00	\$3,669.77
336320	TruckVault Inc.	C-FDFSEN5-97C-P5	Ford F-Series Pickup Chief LX CC, dimensions: 30.125L x 48W	\$4,545.00	\$3,892.44
336320	TruckVault Inc.	C-FDFSEN6-04C-BS	F-Series Pickup Chief LX CC	\$4,845.00	\$4,149.37
336320	TruckVault Inc.	C-FDFSEN6-04C-PT-BS	Ford F-Series Pickup Chief LX CC, dimensions: 30.125L x 47.5W	\$5,540.00	\$4,744.58
336320	TruckVault Inc.	C-FDFSEN6-97C-P5	Ford F-Series Pickup Chief LX CC, dimensions: 30.125L x 48W	\$4,845.00	\$4,149.37
336320	TruckVault Inc.	C-FDFSES2-97S-P5-VP	Ford F-Series Pickup Surveyor, dimensions: 78L x 48W	\$4,115.00	\$3,524.18
336320	TruckVault Inc.	C-FDFSEU2-15S-VP	F-Series Pickup Surveyor	\$4,005.00	\$3,429.97
336320	TruckVault Inc.	C-FDFSEU4-15S-ZC9702	F-150 Utility 4 Dwr stacked	\$5,695.00	\$4,877.33
336320	TruckVault Inc.	C-FDMAXN2-18N-TR-C3-HT-ZC9025	Expedition Max Custom	\$4,825.00	\$4,132.24
336320	TruckVault Inc.	C-FDMAXN2-18N-TR-TT-C11-ZC9022	Expedition Max Custom	\$6,775.00	\$5,802.27
336320	TruckVault Inc.	C-FDMAXN2-18N-ZC11322A	Expedition Max Custom	\$3,135.00	\$2,684.89
336320	TruckVault Inc.	C-FDMAXN3-18D-TR	Expedition Max Special Ops Ctr3rd Row Removed/SSV	\$3,925.00	\$3,361.46
336320	TruckVault Inc.	C-FDMAXN3-18I	Expedition Max Investigator	\$3,925.00	\$3,361.46
336320	TruckVault Inc.	C-FDMAXN3-18I-TR	Expedition Max Investigator	\$3,925.00	\$3,361.46
336320	TruckVault Inc.	C-FDMAXN3-18N-C1-ZC11103A	Expedition Max CustomC11103A	\$4,735.00	\$4,055.16
336320	TruckVault Inc.	C-FDMAXN3-18N-TF-C1-ZC11526B	Expedition Max Custom	\$3,560.00	\$3,048.87
336320	TruckVault Inc.	C-FDMAXN3-18N-TR-C1-ZC11697B	Expedition Max Custom	\$5,120.00	\$4,384.89
336320	TruckVault Inc.	C-FDMAXN3-18N-ZC9144	Expedition Max	\$4,055.00	\$3,472.80
336320	TruckVault Inc.	C-FDMAXN3-18N-ZC9547	Expedition Max 3 Drawer Stacked	\$3,975.00	\$3,404.28

336320	TruckVault Inc.	C-FDMAXN3-18R-PP-TR	Expedition Max Field Ranger3rd Row Removed or PPV Cage	\$3,445.00	\$2,950.38
336320	TruckVault Inc.	C-FDMAXN3-18R-TR	Expedition Max Field Ranger	\$3,445.00	\$2,950.38
336320	TruckVault Inc.	C-FDMAXN4-18N-TR-C2-ZC8043	Expedition Max Cust	\$4,755.00	\$4,072.29
336320	TruckVault Inc.	C-FDMAXN4-18N-TR-ZC9147	2 Mag on Bottom, 2 Utility on top	\$4,785.00	\$4,097.98
336320	TruckVault Inc.	C-FDMAXN5-18P	Expedition Max Captain LX CC	\$4,095.00	\$3,507.05
336320	TruckVault Inc.	C-FDMAXN6-18C	Expedition Max Chief LX CC	\$4,845.00	\$4,149.37
336320	TruckVault Inc.	C-FDMAXN6-18C-TR	Expedition Max Chief LX CC3rd Seat Removed	\$4,845.00	\$4,149.37
336320	TruckVault Inc.	C-FDRANN3-19S-PC-CR	Ranger Pickup Field Ranger	\$3,795.00	\$3,250.13
336320	TruckVault Inc.	C-FDTRLN5-14F-L7-ZC8606	Transit Connect Custom	\$13,925.00	\$11,925.69
336320	TruckVault Inc.	C-FDTRLN6-14C	Transit Connect Chief CC	\$4,845.00	\$4,149.37
336320	TruckVault Inc.	C-FDTCSN3-14N-Z1	Transit Connect Custom	\$3,695.00	\$3,164.48
336320	TruckVault Inc.	C-FDTRAM2-14N-VP	Transit Surveyor	\$4,115.00	\$3,524.18
336320	TruckVault Inc.	C-FDTRAN5-14N-L7-ZC8606	Transit Custom	\$13,925.00	\$11,925.69
336320	TruckVault Inc.	C-FDTRAN5-14P-HT	Ford Transit Captain LX CC	\$4,790.00	\$4,102.27
336320	TruckVault Inc.	C-FDTRAN6-14T-HT	Transit Tac Center	\$5,540.00	\$4,744.58
336320	TruckVault Inc.	C-FDTRLN1-14N-PP-C1-ZC8214	Transit Cust	\$2,975.00	\$2,547.86
336320	TruckVault Inc.	C-FDTRLN5-14P	Ford Transit Captain LX CC	\$4,095.00	\$3,507.05
336320	TruckVault Inc.	C-GMACAN3-07I	Acadia Investigator	\$3,825.00	\$3,275.82
336320	TruckVault Inc.	C-GMACAN3-07I-PT	Acadia Investigator	\$4,520.00	\$3,871.03
336320	TruckVault Inc.	C-GMACAN3-07R	Acadia Field Ranger	\$3,245.00	\$2,779.09
336320	TruckVault Inc.	C-GMACAN3-17I	Acadia Investigator	\$3,615.00	\$3,095.97
336320	TruckVault Inc.	C-GMACAN4-17N-Z1	Acadia Cust CC	\$3,075.00	\$2,633.50
336320	TruckVault Inc.	C-GMCANN3-15S-PC-BH-PW	Canyon Pickup	\$4,245.00	\$3,635.52
336320	TruckVault Inc.	C-GMCANN3-15S-PC-CR	Canyon Pickup Field Ranger	\$4,145.00	\$3,549.87
336320	TruckVault Inc.	C-GMENVN3-02I	Envoy Investigator	\$3,615.00	\$3,095.97
336320	TruckVault Inc.	C-GMHH2N3-02I	Hummer H2 Investigator	\$3,825.00	\$3,275.82
336320	TruckVault Inc.	C-GMHH2N3-02R	H2 Field Ranger	\$3,045.00	\$2,607.81
336320	TruckVault Inc.	C-GMHH2N5-06T	Hummer H2 Tac Center	\$4,545.00	\$3,892.44
336320	TruckVault Inc.	C-GMHH2N6-02C	Hummer H2 Chief LX CC	\$4,845.00	\$4,149.37
336320	TruckVault Inc.	C-GMHH3N3-06I-HT	HH3 InvestigatorHeavy Duty Tbl Ext	\$3,965.00	\$3,395.72
336320	TruckVault Inc.	C-GMKSEN3-04R	Sierra Pickup Field Ranger	\$3,645.00	\$3,121.66
336320	TruckVault Inc.	C-GMSAVN4-03N-VP	Full Size Surveyor	\$4,705.00	\$4,029.47
336320	TruckVault Inc.	C-GMSRAM2-20L-P5-VP	Sierra Pickup Surveyor	\$4,125.00	\$3,532.75
336320	TruckVault Inc.	C-GMSRAM2-20S-P5-VP	Sierra Pickup Surveyor	\$4,025.00	\$3,447.10
336320	TruckVault Inc.	C-GMSRAM2-20S-P5-VP-ZC11844	Sierra Surveyor Custom Cubbies	\$4,025.00	\$3,447.10
336320	TruckVault Inc.	C-GMSRAN0-07S-C2-Z1	Sierra Pickup Cab Custom	\$3,345.00	\$2,864.74
336320	TruckVault Inc.	C-GMSRAN2-07S-VP	Sierra Pickup Surveyor	\$4,115.00	\$3,524.18
336320	TruckVault Inc.	C-GMSRAN3-07L-BH	Sierra Pickup BowHunter	\$4,395.00	\$3,763.98
336320	TruckVault Inc.	C-GMSRAN3-07S-BH	Sierra Pickup BowHunter	\$4,195.00	\$3,592.70
336320	TruckVault Inc.	C-GMSRAN3-07S-CR	GMC Sierra Pickup Field Ranger	\$4,545.00	\$3,892.44
336320	TruckVault Inc.	C-GMSRAN3-07S-CR-PT	GMC Sierra Pickup Field Ranger	\$5,240.00	\$4,487.66
336320	TruckVault Inc.	C-GMSRAN3-07S-CR-PW	Sierra AW Field Ranger6' 6" Bed	\$5,195.00	\$4,449.12
336320	TruckVault Inc.	C-GMSRAN3-07S-PC-BH	Sierra Pickup BowHunter	\$3,995.00	\$3,421.41
336320	TruckVault Inc.	C-GMSRAN3-07S-PC-BH-PW	Sierra Pickup	\$4,545.00	\$3,892.44
336320	TruckVault Inc.	C-GMSRAN3-07S-ZC8728	Sierra Pickup Cust 3 Dwr	\$4,985.00	\$4,269.27
336320	TruckVault Inc.	C-GMSRAN3-19S-CR	Sierra Pickup Field Ranger	\$4,545.00	\$3,892.44
336320	TruckVault Inc.	C-GMSRAN3-19S-CR-PW	Sierra AW Field Ranger	\$5,195.00	\$4,449.12
336320	TruckVault Inc.	C-GMSRAN3-19S-CR-PW-ZC11327	Sierra AW Field Ranger	\$5,375.00	\$4,603.27
336320	TruckVault Inc.	C-GMSRAN3-19S-PC-CR	Sierra Pickup Field Ranger	\$4,215.00	\$3,609.82
336320	TruckVault Inc.	C-GMSRAN3-19S-PC-CR-PW	Sierra Pickup Field Ranger	\$4,715.00	\$4,038.04
336320	TruckVault Inc.	C-GMSRAN3-19S-PW-ZC10026	Sierra Pickup	\$6,335.00	\$5,425.44
336320	TruckVault Inc.	C-GMSRAN3-20L-P5-CR	Sierra HD Pickup Field Ranger	\$4,045.00	\$3,464.23
336320	TruckVault Inc.	C-GMSRAN3-20S-CR-PW	Sierra AW Field RangerShort Bed AW Field Ranger	\$5,195.00	\$4,449.12
336320	TruckVault Inc.	C-GMSRAN3-20S-P5-CR-PW-ZC11703	Sierra AW Field Ranger Offset	\$4,845.00	\$4,149.37
336320	TruckVault Inc.	C-GMSRAN5-07S-C6-Z1	Sierra Pickup Custom CC	\$6,065.00	\$5,194.21
336320	TruckVault Inc.	C-GMTERN2-10I	Terrain Investigator 2 drawer	\$3,175.00	\$2,719.14
336320	TruckVault Inc.	C-GMTERN2-18I	Terrain Investigator 2 drawer	\$3,175.00	\$2,719.14
336320	TruckVault Inc.	C-GMTERN3-10I	Terrain Investigator	\$3,725.00	\$3,190.18
336320	TruckVault Inc.	C-GMTERN3-10R	Terrain Field Ranger	\$3,045.00	\$2,607.81
336320	TruckVault Inc.	C-GMTERN3-18I	Terrain Investigator	\$3,615.00	\$3,095.97
336320	TruckVault Inc.	C-GMYDEM2-15N-Z1	Yukon Denali Mag Stacked 2 Dwr	\$2,285.00	\$1,956.93
336320	TruckVault Inc.	C-GMYDEN2-12N-PT-ZC10065	Yukon/Denali Custom	\$4,005.00	\$3,429.97
336320	TruckVault Inc.	C-GMYDEN2-15N-HT-ZC11363	Yukon Denali Custom	\$4,285.00	\$3,669.77
336320	TruckVault Inc.	C-GMYDEN3-00D	Yukon/Denali Special Ops Ctr	\$3,825.00	\$3,275.82
336320	TruckVault Inc.	C-GMYDEN3-07D	Yukon/Denali Special Ops Ctr	\$3,825.00	\$3,275.82
336320	TruckVault Inc.	C-GMYDEN3-07I	Yukon Denali	\$3,825.00	\$3,275.82
336320	TruckVault Inc.	C-GMYDEN3-07R	Yukon/Denali Field Ranger	\$3,245.00	\$2,779.09



336320	TruckVault Inc.	C-JPCMDN2-06I	Commander Investigator	\$3,225.00	\$2,761.96
336320	TruckVault Inc.	C-JPCMDN3-06I	Commander Investigator	\$3,725.00	\$3,190.18
336320	TruckVault Inc.	C-JPCMDN3-06R	Commander Field Ranger	\$3,045.00	\$2,607.81
336320	TruckVault Inc.	C-JPCMDN5-06C	Jeep Commander Chief LX CC, dimensions: 0L x 0W	\$4,545.00	\$3,892.44
336320	TruckVault Inc.	C-JPCMDN6-06C	Jeep Commander Chief LX CC, dimensions: 0L x 0W	\$4,845.00	\$4,149.37
336320	TruckVault Inc.	C-JPCPSN3-07R	Compass Field Ranger	\$3,045.00	\$2,607.81
336320	TruckVault Inc.	C-JPGCHN2-11I	Grand Cherokee Investigator 2 Dwr	\$3,225.00	\$2,761.96
336320	TruckVault Inc.	C-JPGCHN2-11N-HT-ZC10056	Grand Cherokee 2 DwrStacked HD Table	\$3,745.00	\$3,207.30
336320	TruckVault Inc.	C-JPGCHN2-11N-ZC11260	Grand CherokeeC11260	\$3,475.00	\$2,976.07
336320	TruckVault Inc.	C-JPGCHN3-05D	Jeep Grand Cherokee Special Ops Ctr, dimensions: 0L x 0W	\$3,725.00	\$3,190.18
336320	TruckVault Inc.	C-JPGCHN3-05I	Jeep Grand Cherokee Investigator, dimensions: 30.125L x 43.75W	\$3,725.00	\$3,190.18
336320	TruckVault Inc.	C-JPGCHN3-05I-PT	Jeep Grand Cherokee Investigator, dimensions: 30.125L x 43.75W	\$4,420.00	\$3,785.39
336320	TruckVault Inc.	C-JPGCHN3-11D	Jeep Grand Cherokee Special Ops Ctr, dimensions: 32L x 40W	\$3,725.00	\$3,190.18
336320	TruckVault Inc.	C-JPGCHN3-11I	Jeep Grand Cherokee Investigator, dimensions: 32L x 40W	\$3,725.00	\$3,190.18
336320	TruckVault Inc.	C-JPGCHN3-11R	Jeep Grand Cherokee Field Ranger, dimensions: 32L x 40W	\$3,045.00	\$2,607.81
336320	TruckVault Inc.	C-JPGCHN3-93R	Jeep Grand Cherokee Field Ranger, dimensions: 20.5L x 36W	\$2,845.00	\$2,436.52
336320	TruckVault Inc.	C-JPGCHN3-99D	Jeep Grand Cherokee Special Ops Ctr, dimensions: 0L x 0W	\$3,725.00	\$3,190.18
336320	TruckVault Inc.	C-JPGCHN3-99I	Jeep Grand Cherokee Investigator, dimensions: 30.5L x 37.5W	\$3,725.00	\$3,190.18
336320	TruckVault Inc.	C-JPGCHN4-11P	Jeep Grand Cherokee Captain LX, dimensions: 30.125L x 40W	\$3,795.00	\$3,250.13
336320	TruckVault Inc.	C-JPGCHN4-11P-HT	Grand Cherokee Captain	\$3,795.00	\$3,250.13
336320	TruckVault Inc.	C-JPGCHN5-11C-HT	Grand Cherokee Chief LX CC	\$5,240.00	\$4,487.66
336320	TruckVault Inc.	C-JPGCHN5-11C-PT	Jeep Grand Cherokee Chief LX CC, dimensions: 30.125L x 40W	\$5,240.00	\$4,487.66
336320	TruckVault Inc.	C-JPGDRN3-20S-CR-PW	Gladiator Pickup Field Ranger	\$4,025.00	\$3,447.10
336320	TruckVault Inc.	C-JPGDRN3-20S-PW-ZC9772	Gladiator Pickup Custom	\$5,425.00	\$4,646.10
336320	TruckVault Inc.	C-JPLIBN3-02I	Jeep Liberty Investigator, dimensions: 0L x 0W	\$3,825.00	\$3,275.82
336320	TruckVault Inc.	C-JPLIBN3-02R	Jeep Liberty Field Ranger, dimensions: 20.5L x 36W	\$2,845.00	\$2,436.52
336320	TruckVault Inc.	C-JPLIBN3-08I	Jeep Liberty Investigator, dimensions: 26.5L x 40.5W	\$3,725.00	\$3,190.18
336320	TruckVault Inc.	C-JPPATN3-07I	Patriot Investigator	\$3,725.00	\$3,190.18
336320	TruckVault Inc.	C-JPPATN3-07R	Jeep Patriot Field Ranger, dimensions: 0L x 0W	\$3,045.00	\$2,607.81
336320	TruckVault Inc.	C-JPW4DN3-18D-HT	Wrangler Special Ops Ctr HD Table	\$4,420.00	\$3,785.39
336320	TruckVault Inc.	C-JPW4DN3-18R	Wrangler 4 Door Field Ranger	\$3,045.00	\$2,607.81
336320	TruckVault Inc.	C-JPW4DN3-18R-HT	Wrangler 4 Door Field Ranger	\$3,740.00	\$3,203.02
336320	TruckVault Inc.	C-JPWGRN3-07R-TR	Jeep Wrangler Field Ranger, dimensions: 38L x 39W	\$3,245.00	\$2,779.09
336320	TruckVault Inc.	C-JPWGRN3-97N-CR-PW	2 Door Wrangler Field Ranger	\$3,145.00	\$2,693.45
336320	TruckVault Inc.	C-JPWULN2-07N-HT-TT-ZC10799	Wrangler Unlimited CustomC10799	\$3,675.00	\$3,147.36
336320	TruckVault Inc.	C-JPWULN3-07D	Jeep Wrangler UL Special Ops Ctr, dimensions: 30.5L x 39W	\$3,725.00	\$3,190.18
336320	TruckVault Inc.	C-JPWULN3-07I-PK	Jeep Wrangler Unlimited Investigator	\$3,725.00	\$3,190.18
336320	TruckVault Inc.	C-JPWULN3-07I-PT	Jeep Wrangler Unlimited Investigato, dimensions: 27.5L x 39W	\$4,420.00	\$3,785.39
336320	TruckVault Inc.	C-JPWULN3-07R	Jeep Wrangler Unlimited FieldRanger, dimensions: 28.5L x 39W	\$3,045.00	\$2,607.81
336320	TruckVault Inc.	C-JPWULN3-18R-PW	Wrangler Unlimited FieldRangerAll-weather	\$3,345.00	\$2,864.74
336320	TruckVault Inc.	C-JPWULN4-07N-PT-ZC9950	Wrangler Unlimited Custom	\$4,815.00	\$4,123.68
336320	TruckVault Inc.	C-JPWULN5-07C	Jeep Wrangler Unlimited Chief, dimensions: 25L x 39.5W	\$4,545.00	\$3,892.44
336320	TruckVault Inc.	C-JPWULN5-07C-PK	Wrangler Unlimited Chief	\$4,545.00	\$3,892.44
336320	TruckVault Inc.	C-KINIRU1-17N-HT-ZC10307	Niro CustomC10307	\$2,375.00	\$2,034.01
336320	TruckVault Inc.	C-KISPON3-15I	Sportage Investigator	\$3,725.00	\$3,190.18
336320	TruckVault Inc.	C-LNNAVN3-03D-PT	Lincoln Navigator Special Ops Ctr, dimensions: 45L x 48W	\$4,520.00	\$3,871.03
336320	TruckVault Inc.	C-LNNAVN3-03I	Lincoln Navigator Investigator, dimensions: 46L x 48W	\$3,825.00	\$3,275.82
336320	TruckVault Inc.	C-LRDEFN3-90R-PW	Defender 130 Pickup Field Ranger	\$4,545.00	\$3,892.44
336320	TruckVault Inc.	C-LRDS2N3-98R-PT	Land Rover Land Rover CUST, dimensions: 29L x 38.5W	\$3,740.00	\$3,203.02
336320	TruckVault Inc.	C-LRDSN3-14D-PT	Land Rover Sport Special Ops CtrPullout Table	\$4,420.00	\$3,785.39
336320	TruckVault Inc.	C-LRLR3N3-05R	Land Rover LR3 Field Ranger, dimensions: 36.5L x 40W	\$3,245.00	\$2,779.09
336320	TruckVault Inc.	C-LRLR4N5-11T	Land Rover LR4 TAC CC	\$4,545.00	\$3,892.44
336320	TruckVault Inc.	C-LRRRSN2-14N-HT-TT-ZC10597A	Range Rover Sport CustomC10597A	\$3,775.00	\$3,233.00
336320	TruckVault Inc.	C-LRRRSN3-06D	Range Rover Sport Special Ops Ctr	\$3,725.00	\$3,190.18
336320	TruckVault Inc.	C-LRRRSN3-14R-HT	Range Rover SportField RangerHD Table	\$3,740.00	\$3,203.02
336320	TruckVault Inc.	C-LXL470N3-99R	Lexus Field Ranger	\$3,245.00	\$2,779.09
336320	TruckVault Inc.	C-LXL57N3-08R	Lexus LX570 Field Ranger, dimensions: 40L x 39W	\$3,245.00	\$2,779.09
336320	TruckVault Inc.	C-MBOSP4-11N-ZC6723	Outlander Sport Custom	\$3,925.00	\$3,361.46
336320	TruckVault Inc.	C-MZCX5N3-13R	CX-5 Field Ranger	\$3,045.00	\$2,607.81
336320	TruckVault Inc.	C-NSARMN5-04C	Nissan Armada Chief LX CC, dimensions: 30.125L x 48W	\$4,545.00	\$3,892.44
336320	TruckVault Inc.	C-NSARMN6-04C	Nissan Armada Chief LX CC, dimensions: 0L x 0W	\$4,845.00	\$4,149.37
336320	TruckVault Inc.	C-NSMURN2-15I	Murano Investigator	\$3,325.00	\$2,847.61
336320	TruckVault Inc.	C-NSMURN3-15D	Murano Special Op Ctr	\$3,725.00	\$3,190.18
336320	TruckVault Inc.	C-NSMURN3-15I	Murano Investigator	\$3,825.00	\$3,275.82
336320	TruckVault Inc.	C-NSPTHN2-13I	Pathfinder Investigator3rd Row Folded	\$3,325.00	\$2,847.61
336320	TruckVault Inc.	C-NSPTHN3-05R	Nissan Field Ranger, dimensions: 36L x 43.5W	\$3,245.00	\$2,779.09
336320	TruckVault Inc.	C-NSPTHN3-13D	Nissan Pathfinder Special Ops Ctr, dimensions: 39L x 40W	\$3,825.00	\$3,275.82



336320	TruckVault Inc.	C-NSPTHN3-13D-HT	Pathfinder Special Ops Ctr HD Table	\$4,520.00	\$3,871.03
336320	TruckVault Inc.	C-NSPTHN3-13I	Pathfinder Investigator	\$3,825.00	\$3,275.82
336320	TruckVault Inc.	C-NSPTHN3-13R	Nissan Pathfinder Field Ranger, dimensions: 36L x 40W	\$3,245.00	\$2,779.09
336320	TruckVault Inc.	C-NSPTHN3-13-ZC10876	Pathfinder 3 Drawer Stacked3rd Row Folded	\$3,565.00	\$3,053.15
336320	TruckVault Inc.	C-NSPTHN5-13T	Nissan Pathfinder Tac Ctr, dimensions: 30.125L x 40W	\$4,545.00	\$3,892.44
336320	TruckVault Inc.	C-NSROGN3-21N-CR-PW	Rogue FieldRanger	\$3,525.00	\$3,018.89
336320	TruckVault Inc.	C-NSROGN5-14P-PT	Rogue Captain LX CC	\$4,790.00	\$4,102.27
336320	TruckVault Inc.	C-NSROGN5-21C	Rouge Chief Command,	\$4,545.00	\$3,892.44
336320	TruckVault Inc.	C-NSTITN3-04S-PC-C5-ZC9193	Titan Pickup Custom	\$4,185.00	\$3,584.13
336320	TruckVault Inc.	C-NSXTEN3-05I	Nissan Nissan X-Terra, dimensions: 29.5L x 39.5W	\$3,725.00	\$3,190.18
336320	TruckVault Inc.	C-SBFORN3-14I	Forester Investigator	\$3,725.00	\$3,190.18
336320	TruckVault Inc.	C-SBFORN3-14R	Forester Field Ranger	\$3,045.00	\$2,607.81
336320	TruckVault Inc.	C-SBOUTN3-09D-PT	Subaru Outback Special Ops Ctr, dimensions: 33L x 41W	\$4,420.00	\$3,785.39
336320	TruckVault Inc.	C-TY4RUM3-10N-T3-ZC8768	4-Runner Cust 3 Dwr	\$3,955.00	\$3,387.15
336320	TruckVault Inc.	C-TY4RUN1-10N-C1-HT-ZC10583B	4-Runner CustomC10583B	\$2,685.00	\$2,299.50
336320	TruckVault Inc.	C-TY4RUN1-10N-C1-HT-ZC10583D	4-Runner CustomC10583D	\$2,685.00	\$2,299.50
336320	TruckVault Inc.	C-TY4RUN2-10I	4-Runner Investigator 2 Dwr	\$3,225.00	\$2,761.96
336320	TruckVault Inc.	C-TY4RUN2-10I-PG	4-Runner Investigator 2 Dwr	\$3,225.00	\$2,761.96
336320	TruckVault Inc.	C-TY4RUN2-10N-ZC9688	4-Runner Investigator	\$3,645.00	\$3,121.66
336320	TruckVault Inc.	C-TY4RUN3-03I	Toyota 4-Runner Investigator, dimensions: 35L x 41W	\$3,725.00	\$3,190.18
336320	TruckVault Inc.	C-TY4RUN3-03I-PT	Toyota 4-Runner Investigator, dimensions: 0L x 0W	\$3,825.00	\$3,275.82
336320	TruckVault Inc.	C-TY4RUN3-03R	Toyota 4-Runner Field Ranger, dimensions: 35L x 41W	\$3,045.00	\$2,607.81
336320	TruckVault Inc.	C-TY4RUN3-10D	Toyota 4-Runner Special Ops Ctr, dimensions: 0L x 0W	\$3,725.00	\$3,190.18
336320	TruckVault Inc.	C-TY4RUN3-10D-HT	4-Runner Special Ops Ctr	\$4,420.00	\$3,785.39
336320	TruckVault Inc.	C-TY4RUN3-10D-PT	4-Runner Special Ops Ctr	\$4,420.00	\$3,785.39
336320	TruckVault Inc.	C-TY4RUN3-10I	Toyota 4-Runner Investigator, dimensions: 33.75L x 41.5W	\$3,725.00	\$3,190.18
336320	TruckVault Inc.	C-TY4RUN3-10I-T3	Toyota 4-Runner Investigator, dimensions: 32L x 43W	\$3,725.00	\$3,190.18
336320	TruckVault Inc.	C-TY4RUN3-10N-HT-ZC8764	4-Runner Custom	\$4,215.00	\$3,609.82
336320	TruckVault Inc.	C-TY4RUN3-10N-PT-ZC11802	4-Runner Custom	\$4,270.00	\$3,656.93
336320	TruckVault Inc.	C-TY4RUN3-10R	4-Runner Field Ranger	\$3,045.00	\$2,607.81
336320	TruckVault Inc.	C-TY4RUN3-10R-HT	4-Runner Field Ranger	\$3,740.00	\$3,203.02
336320	TruckVault Inc.	C-TY4RUN3-96N-ZC10989	4-Runner CustomC10989	\$3,395.00	\$2,907.56
336320	TruckVault Inc.	C-TY4RUN4-10C-ZC11741	4-Runner Chief LX CC	\$4,145.00	\$3,549.87
336320	TruckVault Inc.	C-TY4RUN4-10P-TF	4-Runner Captain CC	\$3,795.00	\$3,250.13
336320	TruckVault Inc.	C-TY4RUN5-10C	4-Runner Chief LX CC	\$4,545.00	\$3,892.44
336320	TruckVault Inc.	C-TYFJCN3-07D	Toyota FJ Special Ops Center, dimensions: 30L x 40W	\$3,725.00	\$3,190.18
336320	TruckVault Inc.	C-TYFJCN3-07R	Toyota FJ Field Ranger, dimensions: 27L x 40W	\$3,045.00	\$2,607.81
336320	TruckVault Inc.	C-TYHLNN2-04I	Highlander Investigator 2 Dwr	\$3,225.00	\$2,761.96
336320	TruckVault Inc.	C-TYHLNN2-14I	Highlander Investigator2 Dwr	\$3,225.00	\$2,761.96
336320	TruckVault Inc.	C-TYHLNN2-14N-ZC10546	Highlander CustomC10546	\$2,965.00	\$2,539.29
336320	TruckVault Inc.	C-TYHLNN3-08D	Toyota Highlander Special Ops Ctr, dimensions: 34L x 41W	\$3,725.00	\$3,190.18
336320	TruckVault Inc.	C-TYHLNN3-08I	Toyota Highlander Investigator, dimensions: 34L x 41W	\$3,725.00	\$3,190.18
336320	TruckVault Inc.	C-TYHLNN3-14I	Highlander Investigator	\$3,725.00	\$3,190.18
336320	TruckVault Inc.	C-TYHLNN5-20P	Highlander Captain LX CC	\$3,999.00	\$3,424.84
336320	TruckVault Inc.	C-TYHLNN6-20C	Highlander Chief LX CC	\$4,845.00	\$4,149.37
336320	TruckVault Inc.	C-TYLDCN3-08D-TR	Landcruiser Special Ops Center	\$3,825.00	\$3,275.82
336320	TruckVault Inc.	C-TYLDCN3-08D-TR-PT	Landcruiser Special Ops Center	\$4,520.00	\$3,871.03
336320	TruckVault Inc.	C-TYLDCN3-08R-TR	Toyota Landcruiser Field Ranger, dimensions: 0L x 0W	\$3,245.00	\$2,779.09
336320	TruckVault Inc.	C-TYLDCN5-08T-TR	Land Cruiser Tac Ctr	\$4,545.00	\$3,892.44
336320	TruckVault Inc.	C-TYRAVN3-18I-PH	Rav 4 Investigator	\$3,725.00	\$3,190.18
336320	TruckVault Inc.	C-TYRAVN3-18I-PH-ZC9318	Rav 4 Custom	\$3,155.00	\$2,702.02
336320	TruckVault Inc.	C-TYRAVN5-15P	Rav 4 Captain LX CC3rd Removed	\$4,095.00	\$3,507.05
336320	TruckVault Inc.	C-TYSEQN3-01I-TR	Toyota Sequoia 3 Dwr, dimensions: 49L x 48W	\$3,925.00	\$3,361.46
336320	TruckVault Inc.	C-TYSEQN3-08R-TF	Toyota Sequoia Field Ranger, dimensions: 44L x 48W	\$3,245.00	\$2,779.09
336320	TruckVault Inc.	C-TYSEQN3-08R-TR	Toyota Sequoia Field Ranger, dimensions: 0L x 0W	\$3,245.00	\$2,779.09
336320	TruckVault Inc.	C-TYSNAN3-11D-PT	Toyota Sienna Special Ops Ctr, dimensions: 42L x 48W	\$4,520.00	\$3,871.03
336320	TruckVault Inc.	C-TYTACN2-05S-VF	Toyota Tacoma Pickup Surveyor, dimensions: 70L x 42.5W	\$4,115.00	\$3,524.18
336320	TruckVault Inc.	C-TYTACN2-05S-VP-PW	Tacoma Pickup Surveyor6' All-Weatherr	\$4,745.00	\$4,063.73
336320	TruckVault Inc.	C-TYTACN3-05S-CR	Tacoma Pickup Field Ranger	\$4,345.00	\$3,721.16
336320	TruckVault Inc.	C-TYTACN3-05S-CR-PW	Tacoma Pickup Field Ranger	\$5,195.00	\$4,449.12
336320	TruckVault Inc.	C-TYTACN3-05S-PC-CR	Tacoma Pickup Field Ranger	\$4,145.00	\$3,549.87
336320	TruckVault Inc.	C-TYTACN3-05S-PC-CR-PW	Tacoma Pickup Field Ranger5' Bed; A/W	\$4,595.00	\$3,935.26
336320	TruckVault Inc.	C-TYTUNM2-07S-PX-VP	Toyota Tundra Pickup Surveyor, dimensions: 60.5L x 48W	\$3,905.00	\$3,344.33
336320	TruckVault Inc.	C-TYTUNM2-07S-VP	Tundra Pickup Surveyor	\$4,115.00	\$3,524.18
336320	TruckVault Inc.	C-TYTUNN3-00S-CR-PW	Tundra AW Field Ranger6' Bed AW Field Ranger	\$5,195.00	\$4,449.12
336320	TruckVault Inc.	C-TYTUNN3-07S-CR	Tundra Pickup Field Ranger	\$4,545.00	\$3,892.44
336320	TruckVault Inc.	C-TYTUNN3-07S-CR-PW	Tundra AW Field Ranger	\$5,195.00	\$4,449.12
336320	TruckVault Inc.	C-TYTUNN3-07S-PW-ZC11458	Tundra All Weather Custom	\$5,375.00	\$4,603.27

336320	TruckVault Inc.	C-TYTUNN3-07S-PX-BH	Toyota Tundra Pickup BowHunter, dimensions: 62.5L x 48W	\$3,995.00	\$3,421.41
336320	TruckVault Inc.	C-TYTUNN3-07S-PX-CR	Tundra Pickup Field Ranger	\$4,345.00	\$3,721.16
336320	TruckVault Inc.	C-TYTUNN3-07S-PX-CR-PW	Tundra Pickup Field Ranger	\$4,895.00	\$4,192.19
336320	TruckVault Inc.	C-TYTUNN6-07C-PT	Tundra Pickup Command CenterShort Bed;	\$5,540.00	\$4,744.58
336320	TruckVault Inc.	C-TYTUNU2-00S-VP	Tundra Pickup Surveyor	\$3,765.00	\$3,224.43
336320	TruckVault Inc.	C-VLXC9N2-14N-HT-ZC8278	XC 90 Cust	\$3,435.00	\$2,941.81
336320	TruckVault Inc.	C-VLXC9N3-03I	Volvo XC 90 Investigator, dimensions: 39L x 42W	\$3,825.00	\$3,275.82
336320	TruckVault Inc.	C-WNREVN4-19N-HT-TT-ZC10828C	Revel Custom Command CenterC10828C	\$5,585.00	\$4,783.12
336320	TruckVault Inc.	D-CHSUBM1-07N-C1-DR2	Suburban Drone Responder 2Tray/3rd Removed	\$2,749.00	\$2,354.31
336320	TruckVault Inc.	D-CHSUBM1-07S-C1-DR2	Suburban Drone Responder 2Behind 3rd Seat	\$2,605.00	\$2,230.98
336320	TruckVault Inc.	D-CHSUBM1-15M-C1-DR2	Suburban Drone Responder 2Tray/3rd Removed Mid-Size	\$2,749.00	\$2,354.31
336320	TruckVault Inc.	D-CHSUBM1-15S-C1-DR2	Suburban Drone Responder 2Behind 3rd Seat	\$2,605.00	\$2,230.98
336320	TruckVault Inc.	D-CHTAHM1-15N-C1-DR2	Tahoe Drone Responder 2Tray/3rd Removed	\$2,749.00	\$2,354.31
336320	TruckVault Inc.	D-CHTAHM2-15N-C1-DR1	Tahoe Drone Responder 1Tray/3rd Removed	\$3,395.00	\$2,907.56
336320	TruckVault Inc.	D-CHTAHM2-15N-C1-DR3	Tahoe Drone Responder 3Tray/3rd Removed	\$3,695.00	\$3,164.48
336320	TruckVault Inc.	D-CHTAHN2-15N-HT-C1-DR6	Tahoe Drone Responder 6Tray/3rd Removed	\$6,995.00	\$5,990.68
336320	TruckVault Inc.	D-CHTAHN2-15N-HT-C1-DR7	Tahoe Drone Responder 7Tray/3rd Removed	\$4,895.00	\$4,192.19
336320	TruckVault Inc.	D-CHTAHN3-15N-C1-DR5	Tahoe Drone Responder 5Tray/3rd Removed	\$6,995.00	\$5,990.68
336320	TruckVault Inc.	D-CHTAHN3-15N-HT-C1-DR4	Tahoe Drone Responder 4Tray/3rd Removed	\$7,995.00	\$6,847.10
336320	TruckVault Inc.	D-CHTAHN3-21N-HT-C1-DR4-TR	Tahoe Drone Responder 4	\$7,995.00	\$6,847.10
336320	TruckVault Inc.	D-CHTAHN3-21N-TF-C1-DR5	Tahoe Drone Responder 5	\$6,995.00	\$5,990.68
336320	TruckVault Inc.	D-CHTAHN3-21N-TF-HT-C1-DR4	Tahoe Drone Responder 4	\$7,995.00	\$6,847.10
336320	TruckVault Inc.	D-CHTAHN3-21N-TR-HT-C1-DR4	Tahoe Drone Responder 4	\$7,995.00	\$6,847.10
336320	TruckVault Inc.	D-DGDURM1-11N-TR-C1-DR2	Durango Drone Responder 2	\$2,749.00	\$2,354.31
336320	TruckVault Inc.	D-DGDURM2-11N-TR-C1-DR1	Durango Drone Responder 1	\$3,395.00	\$2,907.56
336320	TruckVault Inc.	D-DGDURN2-11N-TR-HT-C1-DR7	Durango Drone Responder 73rd Row Removed/SSV	\$4,895.00	\$4,192.19
336320	TruckVault Inc.	D-DGDURN3-11N-TR-HT-C1-DR4	Durango Drone Responder 43rd Row Removed/SSV	\$7,995.00	\$6,847.10
336320	TruckVault Inc.	D-FDEXPN2-18N-TR-HT-C1-DR7	Expedition Drone Responder 7	\$4,895.00	\$4,192.19
336320	TruckVault Inc.	D-FDEXPN3-18N-C1-DR5	EWxpedition Drone Responder 5	\$7,985.00	\$6,838.54
336320	TruckVault Inc.	D-FDEXRM1-20N-PS-C1-DR2	Explorer Drone Responder 2Interceptor	\$2,749.00	\$2,354.31
336320	TruckVault Inc.	D-FDEXRM2-11N-PS-C1-DR1	Explorer Drone Responder 1Interceptor	\$3,395.00	\$2,907.56
336320	TruckVault Inc.	D-FDEXRM2-11N-PS-C1-DR3	Explorer Drone Responder 3Interceptor	\$3,695.00	\$3,164.48
336320	TruckVault Inc.	D-FDEXRM2-11N-PS-PP-C1-DR1	Explorer Drone Responder 1Interceptor; Prisoner Cage	\$3,395.00	\$2,907.56
336320	TruckVault Inc.	D-FDEXRM2-20N-PS-C1-DR1	Explorer Drone Responder 1Interceptor	\$3,395.00	\$2,907.56
336320	TruckVault Inc.	D-FDEXRM2-20N-PS-C1-DR3	Explorer Drone Responder 3Interceptor	\$3,695.00	\$3,164.48
336320	TruckVault Inc.	D-FDEXRN2-11N-PS-HT-C1-DR6	Explorer Drone Responder 6Interceptor	\$6,995.00	\$5,990.68
336320	TruckVault Inc.	D-FDEXRN2-11N-PS-HT-C1-DR7	Explorer Drone Responder 7Interceptor	\$4,895.00	\$4,192.19
336320	TruckVault Inc.	D-FDEXRN2-20N-PS-HT-C1-DR6	Explorer Drone Responder 6Interceptor	\$6,995.00	\$5,990.68
336320	TruckVault Inc.	D-FDEXRN2-20N-PS-HT-C1-DR7	Explorer Drone Responder 7Interceptor	\$4,895.00	\$4,192.19
336320	TruckVault Inc.	D-FDEXRN3-11N-PS-C1-DR5	Explorer Drone Responder 5Interceptor	\$6,995.00	\$5,990.68
336320	TruckVault Inc.	D-FDEXRN3-20N-PS-C1-DR5	Explorer Drone Responder 5Interceptor	\$6,995.00	\$5,990.68
336320	TruckVault Inc.	D-FDEXRN3-20N-PS-HT-C1-DR4	Explorer Drone Responder 4Interceptor	\$7,995.00	\$6,847.10
336320	TruckVault Inc.	D-FDMAXN3-18N-C1-DR5	Expedition Max Drone Responder 5	\$6,995.00	\$5,990.68
336320	TruckVault Inc.	D-FDMAXN3-18N-HT-C1-DR4	Expedition Max Drone Responder 4	\$7,995.00	\$6,847.10
336320	TruckVault Inc.	D-JPGCHN3-11N-HT-C1-DR4	Grand Cherokee Drone Responder 4	\$7,995.00	\$6,847.10
336320	TruckVault Inc.	F-CHSUBN2-00N-C2-ER1	Suburban Emergency Response 1	\$2,449.00	\$2,097.38
336320	TruckVault Inc.	F-CHSUBN2-12N-C2-ER1	Chevrolet Suburban Emergency Response 1, dimensions: 30.125L x 48W	\$2,449.00	\$2,097.38
336320	TruckVault Inc.	F-CHSUBN2-12N-C2-ER8	Suburban Emergency Response 8	\$3,749.00	\$3,210.73
336320	TruckVault Inc.	F-CHSUBN2-12N-C4-ER5	Chevrolet Suburban Emergency Response 5, dimensions: 30.125L x 48W	\$3,599.00	\$3,082.27
336320	TruckVault Inc.	F-CHSUBN2-12N-ER7	Chevrolet Suburban Emergency Response 7, dimensions: 30.125L x 48W	\$3,349.00	\$2,868.16
336320	TruckVault Inc.	F-CHSUBN2-15N-C2-ER1	Chevrolet Suburban Emergency Response 1, dimensions: 30.125L x 48W	\$2,449.00	\$2,097.38
336320	TruckVault Inc.	F-CHSUBN2-15N-C2-ER8	Suburban Emergency Response 8	\$3,749.00	\$3,210.73
336320	TruckVault Inc.	F-CHSUBN2-15N-C2-ER8-HT	Suburban Emergency Response 8	\$3,749.00	\$3,210.73
336320	TruckVault Inc.	F-CHSUBN2-15N-C4-ER5	Chevrolet Suburban Emergency Response 5, dimensions: 30.125L x 48W	\$3,599.00	\$3,082.27
336320	TruckVault Inc.	F-CHSUBN2-15N-ER7	Chevrolet Suburban Emergency Response 7, dimensions: 30.125L x 48W	\$3,349.00	\$2,868.16
336320	TruckVault Inc.	F-CHSUBN2-21N-C2-ER1-TR	Suburban Emergency Response 1	\$2,449.00	\$2,097.38
336320	TruckVault Inc.	F-CHSUBN2-21N-C4-ER5-TR	Suburban Emergency Response 5	\$3,599.00	\$3,082.27
336320	TruckVault Inc.	F-CHSUBN2-21N-TF-C2-ER8	Suburban Emergency Response 8	\$3,749.00	\$3,210.73
336320	TruckVault Inc.	F-CHSUBN2-88N-ER7	Suburban Emergency Response 7	\$3,349.00	\$2,868.16
336320	TruckVault Inc.	F-CHSUBN3-12N-C1-ER2	Chevrolet Suburban Emergency Response 2, dimensions: 30.125L x 48W	\$2,749.00	\$2,354.31
336320	TruckVault Inc.	F-CHSUBN3-12N-C1-ER3	Chevrolet Suburban Emergency Response 3, dimensions: 30.125L x 48W	\$2,849.00	\$2,439.95

336320	TruckVault Inc.	F-CHSUBN3-15N-C1-ER2	Chevrolet Suburban Emergency Response 2, dimensions: 30.125L x 48W	\$2,749.00	\$2,354.31
336320	TruckVault Inc.	F-CHSUBN3-15N-C1-ER3	Chevrolet Suburban Emergency Response 3, dimensions: 30.125L x 48W	\$2,849.00	\$2,439.95
336320	TruckVault Inc.	F-CHSUBN4-12N-C1-ER4	Chevrolet Suburban Emergency Response 4, dimensions: 30.125L x 48W	\$3,149.00	\$2,696.88
336320	TruckVault Inc.	F-CHSUBN4-15N-C1-ER4	Chevrolet Suburban Emergency Response 4, dimensions: 30.125L x 48W	\$3,149.00	\$2,696.88
336320	TruckVault Inc.	F-CHSUBN5-12N-ER6	Chevrolet Suburban Emergency Response 6, dimensions: 30.125L x 48W	\$3,599.00	\$3,082.27
336320	TruckVault Inc.	F-CHSUBN5-15N-ER6	Chevrolet Suburban Emergency Response 6, dimensions: 30.125L x 48W	\$3,599.00	\$3,082.27
336320	TruckVault Inc.	F-CHTAHN2-12N-C2-ER1	Chevrolet Tahoe Emergency Response 1, dimensions: 30.125L x 48W	\$2,449.00	\$2,097.38
336320	TruckVault Inc.	F-CHTAHN2-12N-C2-ER8	Tahoe Emergency Response 8	\$3,749.00	\$3,210.73
336320	TruckVault Inc.	F-CHTAHN2-12N-C2-ER8-BS	Tahoe Emergency Response 8	\$3,749.00	\$3,210.73
336320	TruckVault Inc.	F-CHTAHN2-12N-C4-ER5	Chevrolet Tahoe Emergency Response 5, dimensions: 30.125L x 48W	\$3,599.00	\$3,082.27
336320	TruckVault Inc.	F-CHTAHN2-12N-ER7	Chevrolet Tahoe Emergency Response 7, dimensions: 30.125L x 48W	\$3,349.00	\$2,868.16
336320	TruckVault Inc.	F-CHTAHN2-15N-C2-ER1	Chevrolet Tahoe Emergency Response 1, dimensions: 30.125L x 48W	\$2,449.00	\$2,097.38
336320	TruckVault Inc.	F-CHTAHN2-15N-C2-ER1-ZC11799	Tahoe Emergency Response 1	\$2,399.00	\$2,054.56
336320	TruckVault Inc.	F-CHTAHN2-15N-C2-ER8	Tahoe Emergency Response 8	\$3,749.00	\$3,210.73
336320	TruckVault Inc.	F-CHTAHN2-15N-C2-ER8-ZC8115	Tahoe Custom Emergency Response 8	\$4,515.00	\$3,866.75
336320	TruckVault Inc.	F-CHTAHN2-15N-C4-ER5	Chevrolet Tahoe Emergency Response 5, dimensions: 30.125L x 46W	\$3,599.00	\$3,082.27
336320	TruckVault Inc.	F-CHTAHN2-15N-ER7	Chevrolet Tahoe Emergency Response 7, dimensions: 30.125L x 48W	\$3,349.00	\$2,868.16
336320	TruckVault Inc.	F-CHTAHN2-15N-ER7-ZC11018	Tahoe Emergency Response 7Tray/3rd Removed Narrowed for Cargo Glide	\$3,455.00	\$2,958.94
336320	TruckVault Inc.	F-CHTAHN2-21N-C2-ER1-TR	Tahoe Emergency Response 1	\$2,449.00	\$2,097.38
336320	TruckVault Inc.	F-CHTAHN2-21N-C2-ER1-TR-ZC1167	Tahoe Custom Emergency Response 1	\$3,595.00	\$3,078.84
336320	TruckVault Inc.	F-CHTAHN2-21N-C4-ER5-TR	Tahoe Emergency Response 5	\$3,599.00	\$3,082.27
336320	TruckVault Inc.	F-CHTAHN2-21N-ER7-TR	Tahoe Emergency Response 7Tray/3rd Removed	\$3,349.00	\$2,868.16
336320	TruckVault Inc.	F-CHTAHN3-00N-C1-ER3	Chevrolet Tahoe Emergency Response 3, dimensions: 30.125L x 48W	\$2,849.00	\$2,439.95
336320	TruckVault Inc.	F-CHTAHN3-12N-C1-ER2	Chevrolet Tahoe Emergency Response 2, dimensions: 30.125L x 48W	\$2,749.00	\$2,354.31
336320	TruckVault Inc.	F-CHTAHN3-12N-C1-ER3	Chevrolet Tahoe Emergency Response 3, dimensions: 30.125L x 48W	\$2,849.00	\$2,439.95
336320	TruckVault Inc.	F-CHTAHN3-12N-C1-ER3-TR	Tahoe Emergency Response 3	\$2,849.00	\$2,439.95
336320	TruckVault Inc.	F-CHTAHN3-12N-C1-ER3-ZC9254	Tahoe Emergency Response 3	\$2,995.00	\$2,564.99
336320	TruckVault Inc.	F-CHTAHN3-15N-C1-ER2	Chevrolet Tahoe Emergency Response 2, dimensions: 30.125L x 48W	\$2,749.00	\$2,354.31
336320	TruckVault Inc.	F-CHTAHN3-15N-C1-ER2-ZC11752	Tahoe Emergency Response 2 Custom	\$2,749.00	\$2,354.31
336320	TruckVault Inc.	F-CHTAHN3-15N-C1-ER3	Chevrolet Tahoe Emergency Response 3, dimensions: 30.125L x 48W	\$2,849.00	\$2,439.95
336320	TruckVault Inc.	F-CHTAHN3-15N-C1-ER3-ZC9223	Tahoe Emergency Response 3	\$3,275.00	\$2,804.79
336320	TruckVault Inc.	F-CHTAHN3-21N-TR-C1-ER2	Tahoe Emergency Response 23rd Seat Removed	\$2,749.00	\$2,354.31
336320	TruckVault Inc.	F-CHTAHN4-12N-C1-ER4	Chevrolet Tahoe Emergency Response 4, dimensions: 30.125L x 48W	\$3,149.00	\$2,696.88
336320	TruckVault Inc.	F-CHTAHN4-15N-C1-ER4	Chevrolet Tahoe Emergency Response 4, dimensions: 30.125L x 48W	\$3,149.00	\$2,696.88
336320	TruckVault Inc.	F-CHTAHN4-15N-HT-C1-ER4	Tahoe Emergency Response 4	\$3,844.00	\$3,292.09
336320	TruckVault Inc.	F-CHTAHN4-21N-TR-C1-ER4	Tahoe Emergency Response 43rd Removed	\$3,149.00	\$2,696.88
336320	TruckVault Inc.	F-CHTAHN4-21N-TR-HT-C1-ER4	Tahoe Emergency Response 43rd Removed; Heavy Duty Table	\$3,844.00	\$3,292.09
336320	TruckVault Inc.	F-CHTAHN5-00N-ER6	Tahoe Emergency Response 6	\$3,599.00	\$3,082.27
336320	TruckVault Inc.	F-CHTAHN5-12N-ER6	Chevrolet Tahoe Emergency Response 6, dimensions: 30.125L x 48W	\$3,599.00	\$3,082.27
336320	TruckVault Inc.	F-CHTAHN5-15N-C1-ER4-ZC9336	Tahoe Emergency Response 4	\$4,155.00	\$3,558.44
336320	TruckVault Inc.	F-CHTAHN5-15N-ER6	Chevrolet Tahoe Emergency Response 6, dimensions: 0L x 0W	\$3,599.00	\$3,082.27
336320	TruckVault Inc.	F-CHTAHN5-15N-ER6-HT	Tahoe Emergency Response 6	\$4,294.00	\$3,677.48
336320	TruckVault Inc.	F-CHTLBN2-02N-C2-ER1	Trailblazer Emergency Response 1	\$2,449.00	\$2,097.38
336320	TruckVault Inc.	F-DGDURN2-07N-C3-ER1	Dodge Durango Emergency Response 1, dimensions: 30.125L x 47W	\$2,449.00	\$2,097.38
336320	TruckVault Inc.	F-DGDURN2-11N-C2-ER8	Durango Emergency Response 8	\$3,749.00	\$3,210.73
336320	TruckVault Inc.	F-DGDURN2-11N-C3-ER1	Dodge Durango Emergency Response 1, dimensions: 30.125L x 40W	\$2,449.00	\$2,097.38
336320	TruckVault Inc.	F-DGDURN2-11N-ER7	Dodge Durango Emergency Resp 7, dimensions: 30.125L x 40W	\$3,349.00	\$2,868.16

336320	TruckVault Inc.	F-DGDURN2-11N-TR-C2-ER1	Durango Emergency Response 2	\$2,449.00	\$2,097.38
336320	TruckVault Inc.	F-DGDURN2-11N-TR-C2-ER8	Durango Emergency Response 8	\$3,749.00	\$3,210.73
336320	TruckVault Inc.	F-DGDURN2-11N-TR-C4-ER5	Durango Emergency Response 5	\$3,599.00	\$3,082.27
336320	TruckVault Inc.	F-DGDURN3-11N-C1-ER3	Dodge Durango Emergency Response3, dimensions: 30.125L x 40W	\$2,849.00	\$2,439.95
336320	TruckVault Inc.	F-DGDURN4-11N-C1-ER4	Durango Emergency Response 4	\$3,149.00	\$2,696.88
336320	TruckVault Inc.	F-DGDURN4-11N-TR-C1-ER4	Durango Emergency Response 4	\$3,149.00	\$2,696.88
336320	TruckVault Inc.	F-DGDURN5-11N-ER6	Durango Emergency Response 6	\$3,549.00	\$3,039.45
336320	TruckVault Inc.	F-DGDURN5-11N-TR-ER6	Durango Emergency Response 6	\$3,549.00	\$3,039.45
336320	TruckVault Inc.	F-DGGCVN5-08N-ER6	Grand Caravan Emergency Response6	\$3,599.00	\$3,082.27
336320	TruckVault Inc.	F-FDESCN3-20N-C1-ER2	Escape Emergency Response2	\$2,749.00	\$2,354.31
336320	TruckVault Inc.	F-FDEXCN2-00N-ER7	Ford Excursion Emergency Resp 7, dimensions: 30.125L x 48W	\$3,349.00	\$2,868.16
336320	TruckVault Inc.	F-FDEXCN4-00N-C1-ER4	Ford Excursion Emergency Resp 4, dimensions: 30.125L x 48W	\$3,149.00	\$2,696.88
336320	TruckVault Inc.	F-FDEXLN2-07N-C2-ER1	Ford Expedition EL Emergency Resp 1, dimensions: 30.125L x 48W	\$2,449.00	\$2,097.38
336320	TruckVault Inc.	F-FDEXLN2-07N-C2-ER8	Expedition EL Emergency Resp 8	\$3,749.00	\$3,210.73
336320	TruckVault Inc.	F-FDEXLN2-07N-C4-ER5	Ford Expedition EL Emergency Resp 5, dimensions: 30.125L x 48W	\$3,599.00	\$3,082.27
336320	TruckVault Inc.	F-FDEXLN2-07N-ER7	Ford Expedition EL Emergency Resp 7, dimensions: 30.125L x 48W	\$3,349.00	\$2,868.16
336320	TruckVault Inc.	F-FDEXLN3-07N-C1-ER2	Ford Expedition EL Emergency Resp 2, dimensions: 30.125L x 48W	\$2,749.00	\$2,354.31
336320	TruckVault Inc.	F-FDEXLN3-07N-C1-ER3	Ford Expedition EL Emergency Resp 3, dimensions: 30.125L x 48W	\$2,849.00	\$2,439.95
336320	TruckVault Inc.	F-FDEXLN4-07N-C1-ER4	Ford Expedition EL Emergency Resp 4, dimensions: 30.125L x 48W	\$3,149.00	\$2,696.88
336320	TruckVault Inc.	F-FDEXLN5-07N-ER6	Ford Expedition EL Emergency Resp 6, dimensions: 30.125L x 48W	\$3,599.00	\$3,082.27
336320	TruckVault Inc.	F-FDEXPN2-03C-01-C3	Ford Expedition Commander 1, dimensions: 30.125L x 48W	\$3,549.00	\$3,039.45
336320	TruckVault Inc.	F-FDEXPN2-03C-01-C3-PT	Ford Expedition Commander 1, dimensions: 30.125L x 48W	\$4,184.00	\$3,583.27
336320	TruckVault Inc.	F-FDEXPN2-03N-C2-ER1	Ford Expedition Emergency Response1, dimensions: 30.125L x 48W	\$2,449.00	\$2,097.38
336320	TruckVault Inc.	F-FDEXPN2-03N-C2-ER8	Expedition Emergency Response8	\$3,749.00	\$3,210.73
336320	TruckVault Inc.	F-FDEXPN2-03N-C2-PT-ER1	Ford Expedition Emergency Response1, dimensions: 30.125L x 48W	\$2,449.00	\$2,097.38
336320	TruckVault Inc.	F-FDEXPN2-03N-C4-ER5	Ford Expedition Emergency Response5, dimensions: 30.125L x 48W	\$3,599.00	\$3,082.27
336320	TruckVault Inc.	F-FDEXPN2-03N-ER7	Ford Expedition Emergency Response7, dimensions: 30.125L x 48W	\$3,349.00	\$2,868.16
336320	TruckVault Inc.	F-FDEXPN2-18N-C2-ER1	Expedition Emergency Response1	\$2,449.00	\$2,097.38
336320	TruckVault Inc.	F-FDEXPN2-18N-C2-ER8	Expedition Emergency Response8	\$3,749.00	\$3,210.73
336320	TruckVault Inc.	F-FDEXPN2-18N-TR-C2-ER1	Expedition Emergency Response1	\$2,449.00	\$2,097.38
336320	TruckVault Inc.	F-FDEXPN3-03N-C1-ER2	Ford Expedition Emergency Response2, dimensions: 30.125L x 48W	\$2,749.00	\$2,354.31
336320	TruckVault Inc.	F-FDEXPN3-03N-C1-ER3	Ford Expedition Emergency Response3, dimensions: 30.125L x 48W	\$2,849.00	\$2,439.95
336320	TruckVault Inc.	F-FDEXPN3-03N-TR-C1-ER2	Expedition Emergency Response23rd Row Removed	\$2,749.00	\$2,354.31
336320	TruckVault Inc.	F-FDEXPN3-18N-C1-ER2	Expedition Emergency Response2	\$2,749.00	\$2,354.31
336320	TruckVault Inc.	F-FDEXPN3-18N-C1-ER3	Expedition Emergency Response3	\$2,849.00	\$2,439.95
336320	TruckVault Inc.	F-FDEXPN3-18N-TR-C1-ER2	Expedition Emergency Response23rd Row Removed or Never Had 3rd Row	\$2,749.00	\$2,354.31
336320	TruckVault Inc.	F-FDEXPN4-03N-C1-ER4	Ford Expedition Emergency Response4, dimensions: 30.125L x 48W	\$3,149.00	\$2,696.88
336320	TruckVault Inc.	F-FDEXPN4-18N-C1-ER4	Expedition Emergency Response4	\$3,149.00	\$2,696.88
336320	TruckVault Inc.	F-FDEXPN4-18N-TR-C1-ER4	Expedition Emergency Response43rd Seat Removed	\$3,149.00	\$2,696.88
336320	TruckVault Inc.	F-FDEXPN5-03N-ER6	Ford Expedition Emergency Response6, dimensions: 30.125L x 48W	\$3,599.00	\$3,082.27
336320	TruckVault Inc.	F-FDEXPN5-18N-ER6	Expedition Emergency Response6	\$3,599.00	\$3,082.27
336320	TruckVault Inc.	F-FDEXPN5-18N-ER6-TR	Expedition Emergency Response 6	\$3,599.00	\$3,082.27
336320	TruckVault Inc.	F-FDEXRN2-06N-C2-ER1	Ford Explorer Emergency Response 1, dimensions: 30.125L x 44W	\$2,449.00	\$2,097.38
336320	TruckVault Inc.	F-FDEXRN2-06N-C2-ER8	Explorer Emergency Response 8	\$3,749.00	\$3,210.73
336320	TruckVault Inc.	F-FDEXRN2-11N-C2-ER1	Explorer Emergency Response 1	\$2,449.00	\$2,097.38
336320	TruckVault Inc.	F-FDEXRN2-11N-PS-C2-ER1	Explorer Emergency Response 1	\$2,185.00	\$1,871.28
336320	TruckVault Inc.	F-FDEXRN2-11N-PS-C2-ER8	Explorer Emergency Response 8	\$3,749.00	\$3,210.73
336320	TruckVault Inc.	F-FDEXRN2-11N-PS-C4-ER5	Ford Explorer Emergency Response 5, dimensions: 30.125L x 40W	\$3,599.00	\$3,082.27
336320	TruckVault Inc.	F-FDEXRN2-11N-PS-ER7	Ford Explorer Emergency Response 7, dimensions: 30.125L x 40W	\$3,349.00	\$2,868.16

336320	TruckVault Inc.	F-FDEXRN2-11N-PS-ER7-LT	Ford Explorer Emergency Response 7, dimensions: 30.125L x 40W	\$3,944.00	\$3,377.73
336320	TruckVault Inc.	F-FDEXRN2-20N-C2-ER1	Explorer Emergency Response 1	\$2,449.00	\$2,097.38
336320	TruckVault Inc.	F-FDEXRN2-20N-PS-C2-ER1	Explorer Emergency Response 1	\$2,449.00	\$2,097.38
336320	TruckVault Inc.	F-FDEXRN2-20N-PS-C2-ER8	Explorer Emergency Response 8	\$3,749.00	\$3,210.73
336320	TruckVault Inc.	F-FDEXRN2-20N-PS-C4-ER5	Explorer Emergency Response 5	\$3,599.00	\$3,082.27
336320	TruckVault Inc.	F-FDEXRN2-20N-PS-ER7-LT	Explorer Emergency Response 7	\$4,149.00	\$3,553.30
336320	TruckVault Inc.	F-FDEXRN3-06N-C1-ER2	Ford Explorer Emergency Response 2, dimensions: 30.125L x 44W	\$2,749.00	\$2,354.31
336320	TruckVault Inc.	F-FDEXRN3-06N-C1-ER3	Ford Explorer Emergency Response 3, dimensions: 30.125L x 44W	\$2,849.00	\$2,439.95
336320	TruckVault Inc.	F-FDEXRN3-11N-C1-ER3	Ford Explorer Emergency Response 3, dimensions: 30.125L x 40W	\$2,849.00	\$2,439.95
336320	TruckVault Inc.	F-FDEXRN3-11N-PS-C1-ER2	Ford Explorer Emergency Response 2, dimensions: 30.125L x 40W	\$2,749.00	\$2,354.31
336320	TruckVault Inc.	F-FDEXRN3-11N-PS-C1-ER3	Ford Explorer Emergency Response 3, dimensions: 30.125L x 40W	\$2,849.00	\$2,439.95
336320	TruckVault Inc.	F-FDEXRN3-11N-PS-C1-ER8-ZC9669	Explorer CUST Emerg Response 8	\$4,345.00	\$3,721.16
336320	TruckVault Inc.	F-FDEXRN3-11N-PS-C1-ER8-ZC9694	Explorer CUST Emerg Response 8	\$4,345.00	\$3,721.16
336320	TruckVault Inc.	F-FDEXRN3-11N-PS-C1-PT-ER3	Ford Explorer Emergency Response 3, dimensions: 30.125L x 40W	\$2,849.00	\$2,439.95
336320	TruckVault Inc.	F-FDEXRN3-20N-PS-C1-ER2	Explorer Emergency Response 2	\$2,749.00	\$2,354.31
336320	TruckVault Inc.	F-FDEXRN3-20N-PS-C1-ER3	Explorer Emergency Response 3	\$2,849.00	\$2,439.95
336320	TruckVault Inc.	F-FDEXRN4-11N-C1-ER4	Ford Explorer Emergency Response 4, dimensions: 30.125L x 40W	\$3,149.00	\$2,696.88
336320	TruckVault Inc.	F-FDEXRN4-11N-PS-C1-ER4	Ford Explorer Emergency Response 4, dimensions: 30.125L x 40W	\$3,149.00	\$2,696.88
336320	TruckVault Inc.	F-FDEXRN4-20N-PS-C1-ER4	Explorer Emergency Response 4	\$3,149.00	\$2,696.88
336320	TruckVault Inc.	F-FDEXRN5-11N-PS-ER6	Ford Explorer Emergency Response 6, dimensions: 30.125L x 40W	\$3,599.00	\$3,082.27
336320	TruckVault Inc.	F-FDEXRN5-20N-PS-ER6	Explorer Emergency Response 6	\$3,599.00	\$3,082.27
336320	TruckVault Inc.	F-FDMAXN2-18N-C2-ER1	Expedition Max Emergency Resp 1	\$2,449.00	\$2,097.38
336320	TruckVault Inc.	F-FDMAXN2-18N-C2-ER8	Expedition Max Emergency Resp 8	\$3,749.00	\$3,210.73
336320	TruckVault Inc.	F-FDMAXN2-18N-ER7	Expedition Max Emergency Resp 7	\$3,349.00	\$2,868.16
336320	TruckVault Inc.	F-FDMAXN2-18N-TR-C4-ER5	Expedition Max Emergency Resp 5	\$3,599.00	\$3,082.27
336320	TruckVault Inc.	F-FDMAXN2-18N-TR-ER7	Expedition Max Emergency Resp 7	\$3,349.00	\$2,868.16
336320	TruckVault Inc.	F-FDMAXN3-18N-C1-ER2	Expedition EL Emergency Response 2	\$2,749.00	\$2,354.31
336320	TruckVault Inc.	F-GMYDEN2-07C-02-C3	Yukon/Denali Commander 2	\$2,399.00	\$2,054.56
336320	TruckVault Inc.	F-GMYDEN3-12N-C1-ER2	Yukon/Denali Emergency Resp 2	\$2,749.00	\$2,354.31
336320	TruckVault Inc.	F-GMYDEN3-12N-C1-ER3	Yukon/Denali Emergency Resp 3	\$2,849.00	\$2,439.95
336320	TruckVault Inc.	F-GMYXLN2-00N-C2-ER8	Yukon XL Emergency Response 8	\$3,749.00	\$3,210.73
336320	TruckVault Inc.	F-JPCHSN3-97S-02-C1	Jeep Cherokee Safety 2, dimensions: 24L x 42W	\$2,799.00	\$2,397.13
336320	TruckVault Inc.	M-TVLIFT-2020	TruckVault Lift For PPV	\$695.00	\$595.21
336320	TruckVault Inc.	M-TVLIFT-2020-VAULT	TruckVault Lift For PPV	\$995.00	\$852.14
336320	TruckVault Inc.	N-ADA3XN1-13N-HG	Audi A3 Patrolman, dimensions: 18L x 36W	\$1,665.00	\$1,425.94
336320	TruckVault Inc.	N-ADA4XN1-08N	A4 Patrolman	\$1,695.00	\$1,451.64
336320	TruckVault Inc.	N-ADA4XN1-16N	A4 Patrolman	\$1,665.00	\$1,425.94
336320	TruckVault Inc.	N-ADA7XN1-10N	A7 Patrolman	\$1,695.00	\$1,451.64
336320	TruckVault Inc.	N-ADS3XN1-13N	S3 Patrolman	\$1,665.00	\$1,425.94
336320	TruckVault Inc.	N-ADS3XN1-13N-HG	S3 Patrolman	\$1,665.00	\$1,425.94
336320	TruckVault Inc.	N-ADS3XN1-13N-ZC8060	S3 Cust	\$1,515.00	\$1,297.48
336320	TruckVault Inc.	N-BKLACN1-10N-HG	Lacrosse Patrolman	\$1,665.00	\$1,425.94
336320	TruckVault Inc.	N-BKLACN1-10N-PH-HG	Lacrosse Hybrid Patrolman	\$1,665.00	\$1,425.94
336320	TruckVault Inc.	N-BKLUCN1-06N-HG	Lucern Patrolman	\$1,665.00	\$1,425.94
336320	TruckVault Inc.	N-BM528N1-11N	528I Patrolman	\$1,665.00	\$1,425.94
336320	TruckVault Inc.	N-BW2SEN1-14N-HG	BMW 235	\$1,665.00	\$1,425.94
336320	TruckVault Inc.	N-BW650M1-11N	Mag 1 drawerTrunkVault	\$1,695.00	\$1,451.64
336320	TruckVault Inc.	N-BW750M1-16N	750LI Patrolman	\$1,695.00	\$1,451.64
336320	TruckVault Inc.	N-CACTSN1-11N-HG	CTS-V Patrolman	\$1,665.00	\$1,425.94
336320	TruckVault Inc.	N-CACTSN1-14N-HG	CTS-V PatrolmanTrunkVault; Elevated	\$1,665.00	\$1,425.94
336320	TruckVault Inc.	N-CHCAPN1-11N-HG	Caprice Patrolman	\$1,665.00	\$1,425.94
336320	TruckVault Inc.	N-CHCRZN1-08N-HG	Cruze Patrolman	\$1,665.00	\$1,425.94
336320	TruckVault Inc.	N-CHCRZN1-15N-HG	Cruze Patrolman	\$1,665.00	\$1,425.94
336320	TruckVault Inc.	N-CHIMPN1-06N	Impala Patrolman	\$1,695.00	\$1,451.64
336320	TruckVault Inc.	N-CHIMPN1-06N-HG	Impala Patrolman	\$1,665.00	\$1,425.94
336320	TruckVault Inc.	N-CHIMPN1-14N-HG	Impala Civilian	\$1,665.00	\$1,425.94
336320	TruckVault Inc.	N-CHIMPN1-14N-PH-HG	Impala Hybrid Patrolman	\$1,665.00	\$1,425.94
336320	TruckVault Inc.	N-CHIMPN1-14N-ZC8536	Impala Custom	\$1,235.00	\$1,057.68
336320	TruckVault Inc.	N-CHMALN1-08N-HG	Malibu	\$1,665.00	\$1,425.94
336320	TruckVault Inc.	N-CHMALN1-13N-HG	Malibu	\$1,665.00	\$1,425.94
336320	TruckVault Inc.	N-CHMALN1-16N-HG	Malibu	\$1,665.00	\$1,425.94

336320	TruckVault Inc.	N-CHMALN1-16N-PH-HG	Malibu Hybrid	\$1,665.00	\$1,425.94
336320	TruckVault Inc.	N-CHMALN1-20N-HG	MalibuElevated TrunkVault	\$1,665.00	\$1,425.94
336320	TruckVault Inc.	N-CHSSPN1-14N-HG	Chevy SS	\$1,665.00	\$1,425.94
336320	TruckVault Inc.	N-CR200M1-15N	Chrysler 200 Patrolman, dimensions: 16L x 40W	\$1,695.00	\$1,451.64
336320	TruckVault Inc.	N-CR200N1-15N-HG	200 Patrolman	\$1,665.00	\$1,425.94
336320	TruckVault Inc.	N-DGCHLN1-08N-HG	Challenger Patrolman	\$1,665.00	\$1,425.94
336320	TruckVault Inc.	N-DGCHRN1-06N-HG	Dodge Charger Patrolman, dimensions: 20L x 37W	\$1,665.00	\$1,425.94
336320	TruckVault Inc.	N-DGCHRN2-06N-HG	Charger 2 Dwr Patrolman	\$2,095.00	\$1,794.21
336320	TruckVault Inc.	N-FDCNVL1-06N	Crown Victoria Lid Box	\$1,495.00	\$1,280.35
336320	TruckVault Inc.	N-FDCNVN1-00N-EP	Ford Crown Victoria Equip Patrolman, dimensions: 20.5L x 43.5W	\$1,635.00	\$1,400.25
336320	TruckVault Inc.	N-FDFOCN1-04N-HG	Focus Patrolman	\$1,665.00	\$1,425.94
336320	TruckVault Inc.	N-FDFOCN1-11N-HG	Focus Patrolman	\$1,665.00	\$1,425.94
336320	TruckVault Inc.	N-FDFOCN2-11N	Focus 2 Dwr TrunkVault	\$2,095.00	\$1,794.21
336320	TruckVault Inc.	N-FDFOCN2-11N-HG	Focus 2 Dwr TrunkVault	\$1,665.00	\$1,425.94
336320	TruckVault Inc.	N-FDFUSM1-13N	Fusion Mag 1 Dwr	\$1,695.00	\$1,451.64
336320	TruckVault Inc.	N-FDFUSN1-06N-HG	Fusion Trunk 1 Dwr	\$1,665.00	\$1,425.94
336320	TruckVault Inc.	N-FDFUSN1-13N-HG	Fusion Trunk 1 Dwr	\$1,665.00	\$1,425.94
336320	TruckVault Inc.	N-FDFUSN1-13N-PE-SA	Fusion Trunk 1 Dwr	\$1,305.00	\$1,117.63
336320	TruckVault Inc.	N-FDFUSS1-13N-PH-SA	Fusion Trunk Std 1 Dwr	\$1,525.00	\$1,306.05
336320	TruckVault Inc.	N-FDMGTN1-05N	Mustang GT	\$1,665.00	\$1,425.94
336320	TruckVault Inc.	N-FDMGTN1-15N-HG	Mustang GT	\$1,665.00	\$1,425.94
336320	TruckVault Inc.	N-FDTAUN1-10N-HG	Ford Taurus Patrolman, dimensions: 23L x 38W	\$1,665.00	\$1,425.94
336320	TruckVault Inc.	N-FDTAUN1-10N-PS-HG	Ford Taurus Patrolman, dimensions: 23L x 38W	\$1,665.00	\$1,425.94
336320	TruckVault Inc.	N-FDTAUN1-96N-HG	Taurus Patrolman	\$1,665.00	\$1,425.94
336320	TruckVault Inc.	N-FDTAUN2-10N	Taurus Radio Patrolman	\$2,095.00	\$1,794.21
336320	TruckVault Inc.	N-FDTAUN2-10N-ZC9277	Taurus Custom	\$2,785.00	\$2,385.14
336320	TruckVault Inc.	N-HDACDN1-08N-HG	Honda Accord	\$1,665.00	\$1,425.94
336320	TruckVault Inc.	N-HDACDN1-13N-HG	Honda Accord	\$1,665.00	\$1,425.94
336320	TruckVault Inc.	N-HDACDNO-13N-HG	Honda Accord 2 Dwr Offset	\$1,665.00	\$1,425.94
336320	TruckVault Inc.	N-HDCIVM1-16N	Honda Civic	\$1,695.00	\$1,451.64
336320	TruckVault Inc.	N-HDCIVN1-00N-HG	Honda Civic	\$1,665.00	\$1,425.94
336320	TruckVault Inc.	N-HDCIVN1-11N-HG	Civic Patrolman	\$1,665.00	\$1,425.94
336320	TruckVault Inc.	N-HDCIVN1-16N-HG	Civic Patrolman	\$1,665.00	\$1,425.94
336320	TruckVault Inc.	N-HDINSN1-19N-HG	Honda InsightElevated Vault	\$1,665.00	\$1,425.94
336320	TruckVault Inc.	N-HYACCS1-10N-HG	Accent Patrolman	\$1,665.00	\$1,425.94
336320	TruckVault Inc.	N-HYGENN1-14N-HG	Genesis PatrolmanTrunkVault Elevated	\$1,665.00	\$1,425.94
336320	TruckVault Inc.	N-HYSONN1-09N-HG	Hyundai Sonata Patrolman, dimensions: 18L x 34W	\$1,665.00	\$1,425.94
336320	TruckVault Inc.	N-HYSONN1-14N	Sonata Patrolman	\$1,665.00	\$1,425.94
336320	TruckVault Inc.	N-HYSONN1-14N-HG	Sonata Patrolman	\$1,665.00	\$1,425.94
336320	TruckVault Inc.	N-HYSONN1-20N-HG	Sonata PatrolmanHanging, TrunkVault	\$1,665.00	\$1,425.94
336320	TruckVault Inc.	N-INM35N1-06N-HG	M35	\$1,665.00	\$1,425.94
336320	TruckVault Inc.	N-INQ50N1-14N-HG	Q50 PatrolmanTrunkVault; Elevated	\$1,665.00	\$1,425.94
336320	TruckVault Inc.	N-JRXJLN1-09N	XJ/XJL Patrolman	\$1,665.00	\$1,425.94
336320	TruckVault Inc.	N-KIFORN1-10N-HG	Forte Patrolman	\$1,665.00	\$1,425.94
336320	TruckVault Inc.	N-KIK5N1-19N-HG	K5 PatrolmanElevated TrunkVault	\$1,665.00	\$1,425.94
336320	TruckVault Inc.	N-KIOPTN1-10N-HG	Optima Patrolman	\$1,665.00	\$1,425.94
336320	TruckVault Inc.	N-KIOPTN1-16N-HG	Optima Patrolman	\$1,665.00	\$1,425.94
336320	TruckVault Inc.	N-KIOPTN1-16N-PH-HG	Optima Hybrid Patrolman	\$1,665.00	\$1,425.94
336320	TruckVault Inc.	N-KIOPTN2-16N-HG	Optima 2 Dwr TrunkVault	\$2,095.00	\$1,794.21
336320	TruckVault Inc.	N-LXES3N1-15N-HG	ElevatedTrunkVault	\$1,665.00	\$1,425.94
336320	TruckVault Inc.	N-LXES3N1-18N-HG	ElevatedTrunkVault	\$1,665.00	\$1,425.94
336320	TruckVault Inc.	N-LXG20N1-15N	GS200T Patrolman	\$1,665.00	\$1,425.94
336320	TruckVault Inc.	N-LXRC3N1-15N-HG	Lexus RC350, 1 Dwr	\$1,695.00	\$1,451.64
336320	TruckVault Inc.	N-MDC30N1-15N	C300 TrunkVault	\$1,665.00	\$1,425.94
336320	TruckVault Inc.	N-MDE30N1-17N	E300 TrunkVault	\$1,665.00	\$1,425.94
336320	TruckVault Inc.	N-MDE35N1-10N	E350 TrunkVault	\$1,695.00	\$1,451.64
336320	TruckVault Inc.	N-MDE50N1-03N-HG	E350 TrunkVault	\$1,665.00	\$1,425.94
336320	TruckVault Inc.	N-MDS55N1-05N	S550 TrunkVault	\$1,665.00	\$1,425.94
336320	TruckVault Inc.	N-MYGRMN1-00N	Mercury Grand Marquis Patrolman	\$1,695.00	\$1,451.64
336320	TruckVault Inc.	N-NSALTN1-13N	Altima	\$1,695.00	\$1,451.64
336320	TruckVault Inc.	N-NSALTN1-13N-HG	Altima	\$1,665.00	\$1,425.94
336320	TruckVault Inc.	N-NSALTN1-19N-HG	Altima Patrolman	\$1,665.00	\$1,425.94
336320	TruckVault Inc.	N-NSALTN2-13N-HG	Altima 2 Drawer	\$2,095.00	\$1,794.21
336320	TruckVault Inc.	N-NSLEAS1-17N-HG	Nissan Leaf Standard 1 Drawer	\$1,665.00	\$1,425.94
336320	TruckVault Inc.	N-NSMAXN1-16N-HG	Maxima Patrolman	\$1,665.00	\$1,425.94
336320	TruckVault Inc.	N-NSSENM1-00N	Nissan Sentra	\$1,695.00	\$1,451.64
336320	TruckVault Inc.	N-NSSENN1-00N-HG	Nissan Sentra	\$1,665.00	\$1,425.94

336320	TruckVault Inc.	N-POG8XN1-08N	Pontiac G8 1 Dwr	\$1,695.00	\$1,451.64
336320	TruckVault Inc.	N-POG8XN1-08N-HG	Pontiac G8 1 Dwr	\$1,665.00	\$1,425.94
336320	TruckVault Inc.	N-PR911L1-12N	Porsche 911	\$1,345.00	\$1,151.89
336320	TruckVault Inc.	N-SBLEGN1-14N-HG	Legacy Patrolman	\$1,665.00	\$1,425.94
336320	TruckVault Inc.	N-SBWRXN1-16N-HG	WRX	\$1,665.00	\$1,425.94
336320	TruckVault Inc.	N-SCFRSN1-12N	FRS 1 Dwr TrunkVault	\$1,665.00	\$1,425.94
336320	TruckVault Inc.	N-TYAVAN1-18N-HG	Avalon Patrolman	\$1,665.00	\$1,425.94
336320	TruckVault Inc.	N-TYAVNN1-05N-HG	Avalon 1 Dwr	\$1,665.00	\$1,425.94
336320	TruckVault Inc.	N-TYCAMN1-02N	Toyota Camry	\$1,665.00	\$1,425.94
336320	TruckVault Inc.	N-TYCAMN1-07N-HG	Toyota Camry	\$1,665.00	\$1,425.94
336320	TruckVault Inc.	N-TYCAMN1-12N-HG	Toyota Camry	\$1,665.00	\$1,425.94
336320	TruckVault Inc.	N-TYCAMN1-18N-HG	Camry Patrolman	\$1,665.00	\$1,425.94
336320	TruckVault Inc.	N-TYCAMN2-07N-PH	Toyota Camry Hybrid 2 Dwr	\$2,095.00	\$1,794.21
336320	TruckVault Inc.	N-TYCAMN2-94N-ZC8849	Toyota Camry	\$2,365.00	\$2,025.44
336320	TruckVault Inc.	N-TYCORN1-00N	Toyota Corolla	\$1,665.00	\$1,425.94
336320	TruckVault Inc.	N-TYCORN1-00N-HG	Toyota Corolla	\$1,665.00	\$1,425.94
336320	TruckVault Inc.	N-TYCORN1-12N-HG	Toyota Toyota Corolla, dimensions: 18L x 39W	\$1,665.00	\$1,425.94
336320	TruckVault Inc.	N-VWJETN1-19N-HG	Jetta Elevated	\$1,665.00	\$1,425.94
336320	TruckVault Inc.	N-VWPAASN1-12N-HG	Passat Patrolman; Elevated Vault	\$1,665.00	\$1,425.94
336320	TruckVault Inc.	P-405	Parts Std Long Carpeted Dwr Divider, dimensions: 0L x 0W	\$55.00	\$47.10
336320	TruckVault Inc.	P-407	Utility Long Carpeted Dwr Divider	\$65.00	\$55.67
336320	TruckVault Inc.	P-408	Utility Short Carpeted Dwr Divider	\$55.00	\$47.10
336320	TruckVault Inc.	P-410	Parts Mag Short Carpeted Dwr Divider, dimensions: 0L x 0W	\$55.00	\$47.10
336320	TruckVault Inc.	P-415	Parts Std Short Carpeted Dwr Divider, dimensions: 0L x 0W	\$45.00	\$38.54
336320	TruckVault Inc.	P-480	Parts Std Comp. Div Holders - Set, dimensions: 0L x 0W	\$8.00	\$6.85
336320	TruckVault Inc.	P-504	Compression Lock Upgrade,	\$175.00	\$149.87
336320	TruckVault Inc.	P-505	Parts Remote Keyless Entry Lock, dimensions: 0L x 0W	\$375.00	\$321.16
336320	TruckVault Inc.	P-506	Parts Remote Keyless Entry Added Dwr, dimensions: 0L x 0W	\$165.00	\$141.31
336320	TruckVault Inc.	P-507	Parts Upg from PBL, Rem Key Entry, dimensions: 0L x 0W	\$255.00	\$218.39
336320	TruckVault Inc.	P-508	Parts Upg from PBL, Rem Key Entry +1, dimensions: 0L x 0W	\$115.00	\$98.49
336320	TruckVault Inc.	P-509	Remote Keyless Keypad option	\$85.00	\$72.80
336320	TruckVault Inc.	P-510	Remote Button Option	\$115.00	\$98.49
336320	TruckVault Inc.	P-511	Remote Button Option + 1 Drawer	\$85.00	\$72.80
336320	TruckVault Inc.	P-512	Black T-Handle Lock Upgrade	\$180.00	\$154.16
336320	TruckVault Inc.	P-560	Parts In Drawer TTP - 2x 120v, 2x 5v USB,1x 12v, dimensions: 0L x 0W	\$435.00	\$372.54
336320	TruckVault Inc.	P-561	Parts Flush Mount Top TTP - - 2x 120v, 2x 5v USB,1x, dimensions: 0L x 0W	\$255.00	\$218.39
336320	TruckVault Inc.	P-563	2ea 12v Flush Wing Mounted Outlets	\$275.00	\$235.52
336320	TruckVault Inc.	P-565	Parts Top Mount/Cubby TTP - 2x 120v, 2x 5v USB,1x 12v, dimensions: 0L x 0W	\$215.00	\$184.13
336320	TruckVault Inc.	P-566	Parts 12v In Drawer TTP, dimensions: 0L x 0W	\$345.00	\$295.47
336320	TruckVault Inc.	P-567	Parts Wing Mount TTP - 2x 120v, 2x 5v USB,1x 12v, dimensions: 0L x 0W	\$345.00	\$295.47
336320	TruckVault Inc.	P-568	12v Individual Plug	\$35.00	\$29.97
336320	TruckVault Inc.	P-570	Parts 12v - 3 Port Top Mt./Cubby TTP, dimensions: 0L x 0W	\$125.00	\$107.05
336320	TruckVault Inc.	P-571	Parts ProW. SW Xantrax 600 Inverter, dimensions: 0L x 0W	\$355.00	\$304.03
336320	TruckVault Inc.	P-575	Parts ProW. SW 1000 Xantrax Inverter, dimensions: 0L x 0W	\$685.00	\$586.65
336320	TruckVault Inc.	P-577	Xantrax Inverter Remote	\$75.00	\$64.23
336320	TruckVault Inc.	P-578	Kisae Pure Sine 2000w Inverter	\$785.00	\$672.29
336320	TruckVault Inc.	P-590	Parts 5v USB Flush Adapter TTP, dimensions: 0L x 0W	\$25.00	\$21.41
336320	TruckVault Inc.	P-603	Parts S-Size Metal Shroud, dimensions: 0L x 0W	\$395.00	\$338.29
336320	TruckVault Inc.	P-604	Parts M-Size Metal Shroud, dimensions: 0L x 0W	\$545.00	\$466.75
336320	TruckVault Inc.	P-605	Parts F-Size Metal Shroud, dimensions: 0L x 0W	\$645.00	\$552.39
336320	TruckVault Inc.	P-630	Parts Top Surface Coating - Short, dimensions: 0L x 0W	\$385.00	\$329.72
336320	TruckVault Inc.	P-632	Parts Top Surface Coating - Full, dimensions: 0L x 0W	\$665.00	\$569.52
336320	TruckVault Inc.	P-650	4 D-Ring Set	\$55.00	\$47.10
336320	TruckVault Inc.	P-651	Parts 2 D-Ring Set, dimensions: 0L x 0W	\$45.00	\$38.54
336320	TruckVault Inc.	P-672	Parts Tie-Down Rails, dimensions: 0L x 0W	\$155.00	\$132.75
336320	TruckVault Inc.	P-672-SINGLE	Tie-Down Rail	\$85.00	\$72.80
336320	TruckVault Inc.	P-673	Tie-Down Rails	\$195.00	\$167.00
336320	TruckVault Inc.	P-673-SINGLE	Tie-Down Rail	\$105.00	\$89.92
336320	TruckVault Inc.	P-674	Parts Tie-Down Rails, dimensions: 0L x 0W	\$245.00	\$209.82
336320	TruckVault Inc.	P-674-SINGLE	Tie-Down Rail	\$125.00	\$107.05
336320	TruckVault Inc.	P-675	Parts Tie-Down Rails, dimensions: 0L x 0W	\$285.00	\$244.08
336320	TruckVault Inc.	P-675-SINGLE	Tie-Down Rail	\$155.00	\$132.75
336320	TruckVault Inc.	P-676	Parts Tie-Down Rails, dimensions: 0L x 0W	\$325.00	\$278.34
336320	TruckVault Inc.	P-676-SINGLE	Tie-Down Rail	\$175.00	\$149.87
336320	TruckVault Inc.	P-677-SINGLE	Tie-Down Rail	\$215.00	\$184.13

336320	TruckVault Inc.	P-678	Parts Tie-Down Rails, dimensions: 0L x 0W	\$375.00	\$321.16
336320	TruckVault Inc.	P-679	Tie-Down Rail Cargo Rings	\$45.00	\$38.54
336320	TruckVault Inc.	P-680	Top Trim - HDPE Surrounds Top of TruckVault	\$95.00	\$81.36
336320	TruckVault Inc.	P-681	2020 Explorer Interceptor Cover Replacement	\$225.00	\$192.70
336320	TruckVault Inc.	P-690	Cargo Net Small	\$95.00	\$81.36
336320	TruckVault Inc.	P-691	Cargo Net Medium	\$115.00	\$98.49
336320	TruckVault Inc.	P-692	Cargo Net Large	\$155.00	\$132.75
336320	TruckVault Inc.	P-693	Cargo Net X-Large	\$195.00	\$167.00
336320	TruckVault Inc.	P-694	SCBA BRACKET	\$215.00	\$184.13
336320	TruckVault Inc.	P-695	Cargo Net 2" Small	\$145.00	\$124.18
336320	TruckVault Inc.	P-696	Cargo Net 2" Medium	\$195.00	\$167.00
336320	TruckVault Inc.	P-697	Cargo Net 2" Large	\$250.00	\$214.11
336320	TruckVault Inc.	P-698	Cargo Net 2" X-Large	\$295.00	\$252.64
336320	TruckVault Inc.	P-712	Heavy Duty Drawer Slide Upgrade	\$165.00	\$141.31
336320	TruckVault Inc.	P-713	Heavy Duty Drawer Slide Upgrade	\$275.00	\$235.52
336320	TruckVault Inc.	P-714	Heavy Duty Drawer Slide Upgrade	\$455.00	\$389.67
336320	TruckVault Inc.	P-715	Heavy Duty Drawer Slide Upgrade	\$645.00	\$552.39
336320	TruckVault Inc.	P-803	ATF - 2 Piece Padlock Security Brackets	\$35.00	\$29.97
336320	TruckVault Inc.	P-807	6" L-Bracket Lockdown	\$95.00	\$81.36
336320	TruckVault Inc.	P-809	ATF Spec Extra Security Bar	\$235.00	\$201.26
336320	TruckVault Inc.	P-811	A/W Compression Lock Added Security Plate	\$125.00	\$107.05
336320	TruckVault Inc.	P-812	L-Bracket Lockdown	\$95.00	\$81.36
336320	TruckVault Inc.	P-813	Elevated Brackets for Std height	\$300.00	\$256.93
336320	TruckVault Inc.	P-814	Elevated Brackets NCIS Models	\$200.00	\$171.28
336320	TruckVault Inc.	P-816	Vehicle Specific NCIS Lockdown	\$200.00	\$171.28
336320	TruckVault Inc.	P-817	Explorer Elevated Civilian Carpet Kit	\$50.00	\$42.82
336320	TruckVault Inc.	P-864	Table Extension - Magnetic Dry Erase	\$895.00	\$766.50
336320	TruckVault Inc.	P-865	Parts Table Extension, dimensions: 36L x 43W	\$685.00	\$586.65
336320	TruckVault Inc.	P-866	Parts Table Extension - Heavy Duty, dimensions: 26L x 48W	\$695.00	\$595.21
336320	TruckVault Inc.	P-867	Parts Heavy Duty Top Slide Out Tray, dimensions: 26L x 48W	\$695.00	\$595.21
336320	TruckVault Inc.	P-867-Z2	Heavy Duty Top Slide Out Tray	\$925.00	\$792.19
336320	TruckVault Inc.	P-867-ZC11669	Heavy Duty Top Slide Out Tray	\$1,365.00	\$1,169.02
336320	TruckVault Inc.	P-868	Table Extension - Heavy Duty	\$1,195.00	\$1,023.43
336320	TruckVault Inc.	P-869	Elevated Radio Electronics Tray	\$535.00	\$458.19
336320	TruckVault Inc.	P-872	Parts Lrg Magnetic Map Board Upgrade, dimensions: 0L x 0W	\$295.00	\$252.64
336320	TruckVault Inc.	P-873	Parts Sml Magnetic Map Board Upgrade, dimensions: 0L x 0W	\$175.00	\$149.87
336320	TruckVault Inc.	P-875	Table Ext. Plexi Glass Upgrade	\$85.00	\$72.80
336320	TruckVault Inc.	P-876	Map Board Plexi Glass Upgrade	\$95.00	\$81.36
336320	TruckVault Inc.	P-890	Parts Barrel Repl. Key TRU, dimensions: 0L x 0W	\$25.00	\$21.41
336320	TruckVault Inc.	P-891	Parts PBL Repl. PBL SL-#, dimensions: 0L x 0W	\$25.00	\$21.41
336320	TruckVault Inc.	P-894	Parts Black T-Handle Keys, dimensions: 0L x 0W	\$25.00	\$21.41
336320	TruckVault Inc.	P-941-ZC11149	Exterior CUST Map Board & Dwr	\$1,115.00	\$954.91
336320	TruckVault Inc.	P-941-ZC9053	Exterior Custom Map Board Attachment	\$265.00	\$226.95
336320	TruckVault Inc.	P-942	Parts In-Drawer Map Board, No Pencil Tray, dimensions: 0L x 0W	\$265.00	\$226.95
336320	TruckVault Inc.	P-943	Parts In-Drawer Map Board, With Pencil Tray, dimensions: 0L x 0W	\$345.00	\$295.47
336320	TruckVault Inc.	P-949-CAB-CG	CargoGlide Attachment	\$215.00	\$184.13
336320	TruckVault Inc.	P-949-MAGC-CG	CargoGlide Attachment 9 3/4 - 16	\$105.00	\$89.92
336320	TruckVault Inc.	P-949-MAGC-CGXL	CargoGlide Attachment 9 3/4 - 16	\$105.00	\$89.92
336320	TruckVault Inc.	P-949-MAG-CG	CargoGlide Attachment 9 3/4 - 16	\$215.00	\$184.13
336320	TruckVault Inc.	P-949-MAG-CGXL	CargoGlide Attachment 9 3/4 - 16	\$215.00	\$184.13
336320	TruckVault Inc.	P-949-OMGC-CG	CargoGlide Attachment - 14"-21" Tall (over Mag)	\$105.00	\$89.92
336320	TruckVault Inc.	P-949-OMG-CG	CargoGlide Attachment 14" - 21" Tall (Over Magnum)	\$215.00	\$184.13
336320	TruckVault Inc.	P-949-OMG-CGXL	CargoGlide Attachment 14" - 21" Tall (Over Magnum)	\$215.00	\$184.13
336320	TruckVault Inc.	P-949-STDC-CG	CargoGlide Attachment - 7 1/2-11 1/4	\$95.00	\$81.36
336320	TruckVault Inc.	P-949-STDC-CGXL	CargoGlide Attachment 7 1/2 - 11 1/4	\$95.00	\$81.36
336320	TruckVault Inc.	P-949-STD-CG	CargoGlide Attachment - 7 1/2-11 1/4	\$215.00	\$184.13
336320	TruckVault Inc.	P-949-STD-CGXL	CargoGlide Attachment 7 1/2 - 11 1/4	\$195.00	\$167.00
336320	TruckVault Inc.	P-955	Parts Foam for S-Size SUV/TrunkVault, dimensions: 0L x 0W	\$105.00	\$89.92
336320	TruckVault Inc.	P-964	Conversion Kit Floor Mounted Explorer	\$245.00	\$209.82
336320	TruckVault Inc.	P-966	Conversion Kit for TruckVault	\$75.00	\$64.23
336320	TruckVault Inc.	P-967	Conversion Kit for TruckVault	\$75.00	\$64.23
336320	TruckVault Inc.	P-968	Conversion Kit for TruckVault	\$75.00	\$64.23
336320	TruckVault Inc.	P-969	Conversion Kit for TruckVault	\$75.00	\$64.23
336320	TruckVault Inc.	P-969-TF	Conversion Kit for TruckVault 3rd Row Folded	\$75.00	\$64.23
336320	TruckVault Inc.	P-976	Parts Wing Conversion Kit, dimensions: 0L x 0W	\$535.00	\$458.19
336320	TruckVault Inc.	P-977	Parts Wing Conversion Kit, dimensions: 0L x 0W	\$545.00	\$466.75
336320	TruckVault Inc.	P-978	Parts Wing Conversion Kit, dimensions: 0L x 0W	\$555.00	\$475.31



336320	TruckVault Inc.	P-979	Parts Wing Conversion Kit AllWeather, dimensions: 0L x 0W	\$685.00	\$586.65
336320	TruckVault Inc.	P-980	Parts Wing Conversion Kit AllWeather, dimensions: 0L x 0W	\$705.00	\$603.78
336320	TruckVault Inc.	P-981	Parts Wing Conversion Kit AllWeather, dimensions: 0L x 0W	\$725.00	\$620.91
336320	TruckVault Inc.	P-985	Rubber Mat Interior Lining	\$95.00	\$81.36
336320	TruckVault Inc.	P-986	Parts Rubber Mat Interior Lining, dimensions: 0L x 0W	\$155.00	\$132.75
336320	TruckVault Inc.	P-987	Parts Rubber Mat Interior Lining, dimensions: 0L x 0W	\$215.00	\$184.13
336320	TruckVault Inc.	P-988	Rubber Mat Exterior Top Lining	\$95.00	\$81.36
336320	TruckVault Inc.	P-989	Parts Rubber Mat Exterior Top Lining, dimensions: 0L x 0W	\$155.00	\$132.75
336320	TruckVault Inc.	P-990	Parts Rubber Mat Exterior Top Lining, dimensions: 0L x 0W	\$215.00	\$184.13
336320	TruckVault Inc.	P-991	Parts Exterior Power/Radio Panel - Shipped Loose, dimensions: 0L x 0W	\$1,135.00	\$972.04
336320	TruckVault Inc.	P-992	Parts Exterior Power/Radio Panel - Shipped Loose, dimensions: 0L x 0W	\$1,135.00	\$972.04
336320	TruckVault Inc.	P-997	Exterior Radio Panel - Shipped Loose	\$300.00	\$256.93
336320	TruckVault Inc.	P-MB4030	Parts Exterior Map Board & Dwr 40" W x 30" L, dimensions: 30L x 40W	\$1,075.00	\$920.65
336320	TruckVault Inc.	P-MB4030-A	Parts Exterior Map Board & Dwr - 40W x 30L, dimensions: 30L x 40W	\$805.00	\$689.42
336320	TruckVault Inc.	P-MB4830	Parts Exterior Map Board & Dwr 48" Wx 30" L, dimensions: 30L x 48W	\$1,075.00	\$920.65
336320	TruckVault Inc.	P-MB4830-A	Parts Exterior Map Board & Dwr 48" W x 30" L, dimensions: 30L x 48W	\$805.00	\$689.42
336320	TruckVault Inc.	P-SC-24	All Weather Surface Coating - Exposed Areas	\$230.00	\$196.98
336320	TruckVault Inc.	P-SC-36	All Weather Surface Coating - Exposed Areas	\$280.00	\$239.80
336320	TruckVault Inc.	P-SC-48	All Weather Surface Coating - Exposed Areas	\$330.00	\$282.62
336320	TruckVault Inc.	P-SC-60	All Weather Surface Coating - Exposed Areas	\$380.00	\$325.44
336320	TruckVault Inc.	P-SC-72	All Weather Surface Coating - Exposed Areas	\$430.00	\$368.26
336320	TruckVault Inc.	P-SC-84	All Weather Surface Coating - Exposed Areas	\$490.00	\$419.65
336320	TruckVault Inc.	P-SC-96	All Weather Surface Coating - Exposed Areas	\$540.00	\$462.47
336320	TruckVault Inc.	P-SC-I-24	All Weather Coating - Drawer Interior	\$170.00	\$145.59
336320	TruckVault Inc.	P-SC-I-48	All Weather Coating - Drawer Interior	\$260.00	\$222.67
336320	TruckVault Inc.	P-SC-I-72	All Weather Coating - Drawer Interior	\$340.00	\$291.18
336320	TruckVault Inc.	P-SC-I-96	All Weather Coating - Drawer Interior	\$440.00	\$376.83
336320	TruckVault Inc.	P-SC-SF	All Weather Surface Coating - by SQ FT	\$12.00	\$10.28
336320	TruckVault Inc.	P-T-CHEQXXX-18N-PLATFORM	Custom Equinox Platform	\$395.00	\$338.29
336320	TruckVault Inc.	P-T-CHTAHXX-15N-PLATFORM	Custom Tahoe Platform	\$395.00	\$338.29
336320	TruckVault Inc.	P-T-CHTAHXX-21N-PLATFORM	Custom Tahoe Platform	\$395.00	\$338.29
336320	TruckVault Inc.	P-T-CHTRVXX-18N-PLATFORM	Chevrolet Traverse Platform	\$395.00	\$338.29
336320	TruckVault Inc.	P-T-DGDURXX-11N-PLATFORM	Custom Dodge Durango Platform	\$395.00	\$338.29
336320	TruckVault Inc.	P-T-DGJNYXX-09N-PLATFORM	Custom Dodge Journey Platform	\$395.00	\$338.29
336320	TruckVault Inc.	P-T-FDEXPXX-18N-PLATFORM	Custom Expedition Platform	\$395.00	\$338.29
336320	TruckVault Inc.	P-T-FDFLXXX-09N-PLATFORM	Custom Ford Flex Platform	\$395.00	\$338.29
336320	TruckVault Inc.	P-T-GMACAXXX-17N-PLATFORM	Custom Acadia Platform	\$395.00	\$338.29
336320	TruckVault Inc.	P-T-JPCHSXX-14N-PLATFORM	Custom Jeep Cherokee Platform	\$395.00	\$338.29
336320	TruckVault Inc.	P-T-JPGCHXX-11N-PLATFORM	Custom Jeep Grand Cherokee Platform	\$395.00	\$338.29
336320	TruckVault Inc.	S-CHCOLL1-04N-EC	Colorado Pickup SeatVault	\$1,195.00	\$1,023.43
336320	TruckVault Inc.	S-CHSILL1-00N-EC	Silverado Pickup SeatVault	\$1,195.00	\$1,023.43
336320	TruckVault Inc.	S-CHSILL1-07N	Silverado Pickup SeatVault	\$1,195.00	\$1,023.43
336320	TruckVault Inc.	S-CHSILL1-07N-ZC10075	Silverado Pickup SeatVaultWith end door	\$1,245.00	\$1,066.25
336320	TruckVault Inc.	S-CHSILL1-07N-ZC10116	Silverado Pickup SeatVaultWith end door	\$1,245.00	\$1,066.25
336320	TruckVault Inc.	S-CHSILL1-19N	Silverado Pickup SeatVault	\$1,195.00	\$1,023.43
336320	TruckVault Inc.	S-CHSILL1-19N-EC	Silverado Pickup SeatVault	\$1,195.00	\$1,023.43
336320	TruckVault Inc.	S-CHSILL1-19N-ZC11025	Silverado Pickup SeatVault60% Side	\$1,245.00	\$1,066.25
336320	TruckVault Inc.	S-CHSILL1-20N-P5-ZC10438	Silverado 2500 Crew Pickup SeatVault	\$1,105.00	\$946.35
336320	TruckVault Inc.	S-CHSILL2-07N	Silverado Pickup SeatVault	\$1,495.00	\$1,280.35
336320	TruckVault Inc.	S-CHSILL2-19N	Silverado Pickup SeatVault	\$1,495.00	\$1,280.35
336320	TruckVault Inc.	S-CHSILL2-19N-EC	Silverado Pickup SeatVault	\$1,495.00	\$1,280.35
336320	TruckVault Inc.	S-CHSILN2-07N-EC-ZC8616	Silverado Pickup Cust	\$3,025.00	\$2,590.68
336320	TruckVault Inc.	S-CHSILN2-07N-EC-ZC8792	Silverado Pickup Cust	\$2,575.00	\$2,205.29
336320	TruckVault Inc.	S-CHSILN2-07N-ZC8616	Silverado Pickup Cust	\$3,025.00	\$2,590.68
336320	TruckVault Inc.	S-CHSILU2-07N-PC-ZC8413	Silverado Pickup Cust	\$5,655.00	\$4,843.07
336320	TruckVault Inc.	S-DB01M-BK	Vendor Products Day Box - Magnum Height - Prepped for Bracket, dimensions: 16L x 0W	\$445.00	\$381.11
336320	TruckVault Inc.	S-DB01S-BK	Vendor Products Day Box - Standard Height - Prepped for Bracket, dimensions: 16L x 0W	\$395.00	\$338.29
336320	TruckVault Inc.	S-DBBRK-MAG	Vendor Products Daybox Mounting Bracket - Magnum, dimensions: 16L x 0W	\$110.00	\$94.21
336320	TruckVault Inc.	S-DBBRK-STD	Vendor Products Daybox Mounting Bracket - Standard, dimensions: 16L x 0W	\$110.00	\$94.21
336320	TruckVault Inc.	S-DGRAML1-19N	Ram Pickup SeatVault	\$1,195.00	\$1,023.43
336320	TruckVault Inc.	S-DGRAML1-19N-LD	Ram Pickup SeatVaultFactory Floor Lids	\$1,195.00	\$1,023.43
336320	TruckVault Inc.	S-DGRAML2-19N	Ram Pickup SeatVault	\$1,495.00	\$1,280.35

336320	TruckVault Inc.	S-DGRAML2-19S-PC-ZC10269	Ram Pickup Cab VaultC10269	\$1,275.00	\$1,091.94
336320	TruckVault Inc.	S-DGRAMN0-09N-P5-PC-C1-ZC8405	Ram 2500 Pickup Cab VaultC8405	\$895.00	\$766.50
336320	TruckVault Inc.	S-DGRAMN1-19S-PC-ZC10844	Ram Pickup Cab VaultC10844	\$1,555.00	\$1,331.74
336320	TruckVault Inc.	S-DGRAMN2-09S-ZC10669B	Ram Pickup Cab VaultC10669B	\$2,885.00	\$2,470.78
336320	TruckVault Inc.	S-FDFSEL1-04N	F-Series Pickup SeatVault	\$1,195.00	\$1,023.43
336320	TruckVault Inc.	S-FDFSEL1-12N	Ford F-Series Pickup SeatVault, dimensions: 13L x 56W	\$1,195.00	\$1,023.43
336320	TruckVault Inc.	S-FDFSEL1-12N-PK	F-Series Pickup SeatVault	\$1,195.00	\$1,023.43
336320	TruckVault Inc.	S-FDFSEL1-15N	Ford F-Series Pickup SeatVault, dimensions: 13L x 56W	\$1,195.00	\$1,023.43
336320	TruckVault Inc.	S-FDFSEL1-15N-C8834	F-Series Pickup SeatVault	\$1,195.00	\$1,023.43
336320	TruckVault Inc.	S-FDFSEL1-15N-EC	F-Series Pickup SeatVault	\$1,195.00	\$1,023.43
336320	TruckVault Inc.	S-FDFSEL1-15N-EC-ZC8237	F-Series Pickup SeatVault	\$1,235.00	\$1,057.68
336320	TruckVault Inc.	S-FDFSEL1-15N-PK	F-Series Pickup SeatVault	\$1,195.00	\$1,023.43
336320	TruckVault Inc.	S-FDFSEL1-15N-Z2	F-Series Pickup SeatVault	\$1,195.00	\$1,023.43
336320	TruckVault Inc.	S-FDFSEL1-15N-ZC8834	F-Series Pickup SeatVault	\$1,365.00	\$1,169.02
336320	TruckVault Inc.	S-FDFSEL1-17N-P5	F-Series Pickup SeatVault	\$1,195.00	\$1,023.43
336320	TruckVault Inc.	S-FDFSEL1-17N-P5-EC	F-Series Pickup SeatVault	\$1,195.00	\$1,023.43
336320	TruckVault Inc.	S-FDFSEL1-17N-P5-ZC10781A	F-Series Pickup SeatVault	\$1,245.00	\$1,066.25
336320	TruckVault Inc.	S-FDFSEL1-17N-P5-ZC8513	F-Series Pickup SeatVault	\$1,235.00	\$1,057.68
336320	TruckVault Inc.	S-FDFSEL1-17N-P5-ZC9255	F-Series Pickup SeatVault	\$1,365.00	\$1,169.02
336320	TruckVault Inc.	S-FDFSEL1-17S-P5-ZC10569	F-Series Pickup SeatVaultC10569	\$1,245.00	\$1,066.25
336320	TruckVault Inc.	S-FDFSEL1-17S-P5-ZC11145A	F-Series Pickup SeatVaultC11145A	\$1,245.00	\$1,066.25
336320	TruckVault Inc.	S-FDFSEL1-97N-EC	F-Series Pickup SeatVault	\$1,195.00	\$1,023.43
336320	TruckVault Inc.	S-FDFSEL1-97N-P5	F-Series Pickup SeatVault	\$1,195.00	\$1,023.43
336320	TruckVault Inc.	S-FDFSEL1-97N-P5-EC	F-Series Pickup SeatVaultExtended Cab	\$1,195.00	\$1,023.43
336320	TruckVault Inc.	S-FDFSEL2-12N	Ford F-Series Pickup SeatVault, dimensions: 13L x 56W	\$1,495.00	\$1,280.35
336320	TruckVault Inc.	S-FDFSEL2-15N	Ford F-Series Pickup SeatVault, dimensions: 13L x 56W	\$1,495.00	\$1,280.35
336320	TruckVault Inc.	S-FDFSEL2-15N-EC	F-Series Pickup SeatVault	\$1,495.00	\$1,280.35
336320	TruckVault Inc.	S-FDFSEL2-15N-ZC10472	F-Series Pickup SeatVaultC10472	\$1,555.00	\$1,331.74
336320	TruckVault Inc.	S-FDFSEL2-15N-ZC9706	F-Series Pickup SeatVault	\$1,915.00	\$1,640.05
336320	TruckVault Inc.	S-FDFSEL2-17N-P5	F-Series Pickup SeatVault	\$1,495.00	\$1,280.35
336320	TruckVault Inc.	S-FDFSEL2-17N-P5-EC	F-Series Pickup SeatVault	\$1,495.00	\$1,280.35
336320	TruckVault Inc.	S-FDFSEL2-97N-P5-EC	F-Series Pickup SeatVault	\$1,495.00	\$1,280.35
336320	TruckVault Inc.	S-FDFSEN0-15S-PC-ZC11442E	F-Series Pickup Custom	\$1,405.00	\$1,203.27
336320	TruckVault Inc.	S-FDFSEN0-17S-P5-ZC10412	F-Series Pickup CustomRadio Cover C10412	\$305.00	\$261.21
336320	TruckVault Inc.	S-FDFSEN1-15N-ZC8567	F-Series Pickup SeatVault	\$1,655.00	\$1,417.38
336320	TruckVault Inc.	S-FDFSEN4-17N-P5-ZC8870	F-Series Pickup Cust In-Cab Vault	\$4,185.00	\$3,584.13
336320	TruckVault Inc.	S-FDFSES6-17N-P5-ZC8842	F-Series Pickup Cust In-Cab Vault	\$4,855.00	\$4,157.93
336320	TruckVault Inc.	S-FDRANL1-01N-EC	Ranger Pickup SeatVault	\$1,195.00	\$1,023.43
336320	TruckVault Inc.	S-GMSRAL1-07N	Sierra Pickup SeatVault	\$1,195.00	\$1,023.43
336320	TruckVault Inc.	S-GMSRAL1-15N	Sierra Pickup SeatVault	\$1,195.00	\$1,023.43
336320	TruckVault Inc.	S-GMSRAL1-15N-Z1	Sierra Pickup 2/3 SeatVault	\$1,095.00	\$937.78
336320	TruckVault Inc.	S-GMSRAL1-19N	Sierra Pickup SeatVault	\$1,195.00	\$1,023.43
336320	TruckVault Inc.	S-GMSRAL1-19N-ZC9388	Sierra Pickup SeatVault	\$855.00	\$732.24
336320	TruckVault Inc.	S-GMSRAL2-07N	Sierra Pickup SeatVault	\$1,495.00	\$1,280.35
336320	TruckVault Inc.	S-GMSRAL2-15N	Sierra Pickup SeatVault	\$1,495.00	\$1,280.35
336320	TruckVault Inc.	S-GMSRAL2-19N	Sierra Pickup SeatVault	\$1,495.00	\$1,280.35
336320	TruckVault Inc.	S-GMSRAN1-19N-ZC10740	Sierra Pickup SeatVaultC10740	\$1,805.00	\$1,545.84
336320	TruckVault Inc.	S-GMSRAS1-15N-L1-Z1	Sierra Pickup In-Cab Vault	\$2,375.00	\$2,034.01
336320	TruckVault Inc.	S-GMSRAS2-15N-Z1	Sierra Pickup In-Cab Vault	\$2,465.00	\$2,111.08
336320	TruckVault Inc.	S-HDRIDL1-06N	Ridgeline Pickup SeatVault	\$1,195.00	\$1,023.43
336320	TruckVault Inc.	S-HDRIDL1-17N	Ridgeline Pickup SeatVault	\$1,195.00	\$1,023.43
336320	TruckVault Inc.	S-HDRIDL1-17N-ZC9912	Ridgeline Pickup SeatVault	\$1,235.00	\$1,057.68
336320	TruckVault Inc.	S-HDRIDL2-17N	Ridgeline Pickup SeatVault2 lids	\$1,495.00	\$1,280.35
336320	TruckVault Inc.	S-JPGDRL1-20N	Gladiator Pickup SeatVault	\$1,195.00	\$1,023.43
336320	TruckVault Inc.	S-NSTITL1-04N	Titan Pickup SeatVault	\$1,195.00	\$1,023.43
336320	TruckVault Inc.	S-NSTITL1-16N	Titan Pickup SeatVault	\$1,195.00	\$1,023.43
336320	TruckVault Inc.	S-NSTITL2-04N	Titan Pickup SeatVault	\$1,495.00	\$1,280.35
336320	TruckVault Inc.	S-NSTITL2-16N	Titan Pickup SeatVault	\$1,495.00	\$1,280.35
336320	TruckVault Inc.	S-TYTUNL1-07N-PD	Tundra Pickup SeatVault -Double CabOnly for Double Cab	\$1,195.00	\$1,023.43
336320	TruckVault Inc.	T-ACMDXM1-01N	Acura MDX Mag 1 Dwr, dimensions: 36.5L x 46W	\$2,295.00	\$1,965.49
336320	TruckVault Inc.	T-ACMDXM1-07N	Acura MDX Mag 1 Dwr, dimensions: 37L x 47W	\$2,295.00	\$1,965.49
336320	TruckVault Inc.	T-ACMDXM2-01N	Acura MDX Mag 2 Dwr, dimensions: 36.5L x 46W	\$2,845.00	\$2,436.52
336320	TruckVault Inc.	T-ACMDXMO-01N	Acura MDX Mag Offset Dwr, dimensions: 36.5L x 46W	\$2,845.00	\$2,436.52
336320	TruckVault Inc.	T-ACMDXS1-01N	Acura MDX Std 1 Dwr, dimensions: 38L x 46W	\$2,095.00	\$1,794.21
336320	TruckVault Inc.	T-ACMDXS1-01N-HT	MDX Std 1 DwrHeavy Duty Table	\$2,790.00	\$2,389.42
336320	TruckVault Inc.	T-ACMDXS1-07N	Acura MDX Std 1 Dwr, dimensions: 39L x 47W	\$2,095.00	\$1,794.21
336320	TruckVault Inc.	T-ACMDXS1-14N	Acura MDX Std 1 Dwr, dimensions: 36L x 43W	\$2,095.00	\$1,794.21

336320	TruckVault Inc.	T-ACMDXS2-01N	Acura MDX Std 2 Dwr, dimensions: 38L x 46W	\$2,645.00	\$2,265.24
336320	TruckVault Inc.	T-ACMDXS2-07N	Acura MDX Std 2 Dwr, dimensions: 39L x 47W	\$2,645.00	\$2,265.24
336320	TruckVault Inc.	T-ACMDXS2-14N	Acura MDX Std 2 Dwr, dimensions: 36L x 43W	\$2,645.00	\$2,265.24
336320	TruckVault Inc.	T-ACRDXS1-07N	Acura RDX Std 1 Dwr, dimensions: 27L x 38W	\$1,895.00	\$1,622.92
336320	TruckVault Inc.	T-ACRDXS1-13N	RDX Std 1 Dwr	\$1,895.00	\$1,622.92
336320	TruckVault Inc.	T-ACRDXS1-19N	RDX Std 1 Dwr	\$1,895.00	\$1,622.92
336320	TruckVault Inc.	T-ACTLXM1-18N	TLX Mag 1 Dwr	\$1,695.00	\$1,451.64
336320	TruckVault Inc.	T-ADA4RS1-15N	Audi A4 All Road Std 1 Dwr	\$1,895.00	\$1,622.92
336320	TruckVault Inc.	T-ADQ5XM1-05N	Audi Q5 Mag 1 Dwr	\$2,095.00	\$1,794.21
336320	TruckVault Inc.	T-ADQ5XS1-05N	Audi Q5 Std 1 Dwr	\$1,895.00	\$1,622.92
336320	TruckVault Inc.	T-ADQ5XS2-18N	Audi Q5 Std 2 Dwr	\$2,445.00	\$2,093.95
336320	TruckVault Inc.	T-ADQ5XU1-18N	Audi Q5 Utility 1 Dwr	\$1,995.00	\$1,708.56
336320	TruckVault Inc.	T-ADQ5XUO-05N-PT	Audi Q5 Utility 2 Dwr OffsetNo 3rd Row Seat Table	\$3,240.00	\$2,774.81
336320	TruckVault Inc.	T-ADQ7XM1-06N	Audi Audi Q7 Mag 1 Dwr, dimensions: 34L x 46W	\$2,095.00	\$1,794.21
336320	TruckVault Inc.	T-ADQ7XM1-16N	Audi Q7 Mag 1 Dwr	\$2,095.00	\$1,794.21
336320	TruckVault Inc.	T-ADQ7XM1-16S	Audi Q7 Mag 1 Dwr	\$1,895.00	\$1,622.92
336320	TruckVault Inc.	T-ADQ7XM2-06N	Audi Audi Q7 Mag 2 Dwr, dimensions: 34L x 41W	\$2,645.00	\$2,265.24
336320	TruckVault Inc.	T-ADQ7XS1-06N	Audi Audi Q7 Std 1 Dwr, dimensions: 35L x 46W	\$1,895.00	\$1,622.92
336320	TruckVault Inc.	T-ADQ7XS1-06N-PT	Audi Audi Q7 Std 1 Dwr, dimensions: 35L x 46W	\$2,590.00	\$2,218.14
336320	TruckVault Inc.	T-ADQ7XS1-16N	Audi Q7 Std 1 Dwr36" Long	\$2,095.00	\$1,794.21
336320	TruckVault Inc.	T-ADQ7XS1-16S	Audi Q7 Standard 1 Dwr	\$1,695.00	\$1,451.64
336320	TruckVault Inc.	T-ADQ7XS2-06N	Audi Audi Q7 Std 2 Dwr, dimensions: 34L x 40W	\$2,445.00	\$2,093.95
336320	TruckVault Inc.	T-ADQ7XS2-16N	Audi Q7 Std 2 Dwr	\$2,645.00	\$2,265.24
336320	TruckVault Inc.	T-ADQ7XSO-06N	Audi Audi Q7 Std 2 Dwr Offset, dimensions: 34L x 40W	\$2,445.00	\$2,093.95
336320	TruckVault Inc.	T-ADQ7XU1-06N	Audi Q7 Utility 1 Dwr35" Long	\$1,995.00	\$1,708.56
336320	TruckVault Inc.	T-ADQ7XU1-06S	Audi Q7 Utility 1 Dwr	\$1,795.00	\$1,537.28
336320	TruckVault Inc.	T-ADQ7XU1-16N	Audi Q7 Utility 1 Dwr35" Long	\$1,995.00	\$1,708.56
336320	TruckVault Inc.	T-ADQ8XS1-20N	Audi Q8 Std 1 Dwr	\$1,895.00	\$1,622.92
336320	TruckVault Inc.	T-AMHH1M1-94N	Hummer H1 Mag 1 Dwr, dimensions: 47L x 46W	\$2,295.00	\$1,965.49
336320	TruckVault Inc.	T-AMHH1M1-94N-BT	Hummer H1 Mag 1 Dwr, dimensions: 42L x 50W	\$2,295.00	\$1,965.49
336320	TruckVault Inc.	T-AMHH1M1-94N-BT-PW	Hummer H1 Mag 1 Dwr, dimensions: 42L x 50W	\$2,655.00	\$2,273.80
336320	TruckVault Inc.	T-AMHH1M1-94N-PR	Hummer H1 Mag 1 Dwr, dimensions: 41L x 46W	\$2,295.00	\$1,965.49
336320	TruckVault Inc.	T-AMHH1M1-94N-PT	Hummer H1 Mag 1 Dwr, dimensions: 47L x 46W	\$2,990.00	\$2,560.71
336320	TruckVault Inc.	T-AMHH1M2-94N-BT-PW	Hummer H1 Mag 2 Dwr, dimensions: 42L x 49.75W	\$3,095.00	\$2,650.63
336320	TruckVault Inc.	T-AMHH1M2-94N-BT-PW-ZC9439	H1 Mag 2 Dwr	\$3,615.00	\$3,095.97
336320	TruckVault Inc.	T-AMHH1M2-94N-PR	Hummer H1 Mag 2 Dwr, dimensions: 41L x 46W	\$2,845.00	\$2,436.52
336320	TruckVault Inc.	T-AMHH1MO-94N	Hummer H1 Mag OS Dwr, dimensions: 46L x 47W	\$2,845.00	\$2,436.52
336320	TruckVault Inc.	T-AMHH1MO-94N-BT-PW	Hummer H1 Mag 2 Offset, dimensions: 42L x 49.75W	\$3,095.00	\$2,650.63
336320	TruckVault Inc.	T-AMHH1MO-94N-PR	Hummer H1 Mag OS Dwr, dimensions: 41L x 46W	\$2,845.00	\$2,436.52
336320	TruckVault Inc.	T-AMHH1S1-94N	Hummer H1 Std 1 Dwr, dimensions: 47L x 46W	\$2,095.00	\$1,794.21
336320	TruckVault Inc.	T-AMHH1S1-94N-BT	Hummer H1 Std 1 Dwr, dimensions: 42L x 50W	\$2,095.00	\$1,794.21
336320	TruckVault Inc.	T-AMHH1S1-94N-BT-HN-PW	H1 Std 1 Dwr Half WidthTailgate, Any Side, PU Style Bed, A-Wthr	\$2,275.00	\$1,948.36
336320	TruckVault Inc.	T-AMHH1S1-94N-BT-PW	Hummer H1 Std 1 Dwr, dimensions: 42L x 49.75W	\$2,435.00	\$2,085.39
336320	TruckVault Inc.	T-AMHH1S1-94N-HT	H1 Std 1 Dwr HD Table	\$2,720.00	\$2,329.47
336320	TruckVault Inc.	T-AMHH1S1-94N-PR	Hummer H1 Std 1 Dwr, dimensions: 41L x 46W	\$2,095.00	\$1,794.21
336320	TruckVault Inc.	T-AMHH1S2-94N-BT	Hummer H1 Std 2 Dwr, dimensions: 42L x 50W	\$2,645.00	\$2,265.24
336320	TruckVault Inc.	T-AMHH1S2-94N-BT-PT	Hummer H1 Std 2 Dwr, dimensions: 42L x 50W	\$3,340.00	\$2,860.45
336320	TruckVault Inc.	T-AMHH1S2-94N-BT-PW	Hummer H1 Std 2 Dwr, dimensions: 42L x 49.75W	\$2,875.00	\$2,462.22
336320	TruckVault Inc.	T-AMHH1S2-94N-HT	H1 Std 2 Dwr	\$3,120.00	\$2,672.04
336320	TruckVault Inc.	T-AMHH1S2-94N-PR	Hummer H1 Std 2 Dwr, dimensions: 41L x 46W	\$2,645.00	\$2,265.24
336320	TruckVault Inc.	T-AMHH1SO-94N	Hummer H1 Std OS Dwr, dimensions: 47L x 46W	\$2,645.00	\$2,265.24
336320	TruckVault Inc.	T-AMHH1SO-94N-PR	Hummer H1 Std OS Dwr, dimensions: 41L x 46W	\$2,645.00	\$2,265.24
336320	TruckVault Inc.	T-AMHH1SO-94N-PR-PT	Hummer H1 Std OS Dwr, dimensions: 41L x 46W	\$3,340.00	\$2,860.45
336320	TruckVault Inc.	T-BKENCM1-08N	Buick Enclave Mag 1 Dwr, dimensions: 46L x 39.5W	\$2,295.00	\$1,965.49
336320	TruckVault Inc.	T-BKENCM1-08S	Enclave Mag 1 Dwr	\$1,895.00	\$1,622.92
336320	TruckVault Inc.	T-BKENCM2-08N	Buick Enclave Mag 2 Dwr, dimensions: 41L x 41W	\$2,845.00	\$2,436.52
336320	TruckVault Inc.	T-BKENCS1-08N	Buick Enclave Std 1 Dwr, dimensions: 46L x 39.5W	\$2,095.00	\$1,794.21
336320	TruckVault Inc.	T-BKENCS2-08N	Buick Enclave Std 2 Dwr, dimensions: 39.5L x 47.5W	\$2,645.00	\$2,265.24
336320	TruckVault Inc.	T-BKENCS2-18N	Enclave Std 2 Dwr	\$2,645.00	\$2,265.24
336320	TruckVault Inc.	T-BKENRS1-13N	Encore Std 1 Dwr	\$1,495.00	\$1,280.35
336320	TruckVault Inc.	T-BKRENM1-02N	Buick Rendezvous Mag 1 Dwr, dimensions: 0L x 0W	\$2,095.00	\$1,794.21
336320	TruckVault Inc.	T-BKRENM2-02N	Buick Rendezvous Mag 2 Dwr, dimensions: 0L x 0W	\$2,645.00	\$2,265.24
336320	TruckVault Inc.	T-BKRENS1-02N	Buick Rendezvous Std 1 Dwr, dimensions: 0L x 0W	\$1,895.00	\$1,622.92
336320	TruckVault Inc.	T-BKRENS2-02N	Buick Rendezvous Std 2 Dwr, dimensions: 0L x 0W	\$2,445.00	\$2,093.95
336320	TruckVault Inc.	T-BKTRZM2-05N	Buick Terraza Mag 2 Dwr, dimensions: 0L x 0W	\$2,845.00	\$2,436.52
336320	TruckVault Inc.	T-BKTRZM2-05N-PT	Buick Terraza Mag 2 Dwr, dimensions: 46L x 47W	\$3,540.00	\$3,031.74
336320	TruckVault Inc.	T-BKTRZS2-05N	Buick Terraza Std 2 Dwr, dimensions: 0L x 0W	\$2,755.00	\$2,359.45

336320	TruckVault Inc.	T-BW750M1-02N	750Li Mag 1 Dwr	\$1,695.00	\$1,451.64
336320	TruckVault Inc.	T-BW750S1-02N	750Li Std 1 Dwr	\$1,495.00	\$1,280.35
336320	TruckVault Inc.	T-BWF31M1-12N	3 Series Sport Wagon Mag 1 Dwr	\$2,095.00	\$1,794.21
336320	TruckVault Inc.	T-BWF31S1-12N	3 Series Sport Wagon Std 1 Dwr	\$1,895.00	\$1,622.92
336320	TruckVault Inc.	T-BWG20S1-18N	3 Series Sport Wagon Std 1 Dwr	\$1,695.00	\$1,451.64
336320	TruckVault Inc.	T-BWX3NMO-04N	BMW X3 Mag Offset, dimensions: 30L x 38W	\$2,645.00	\$2,265.24
336320	TruckVault Inc.	T-BWX3NS1-04N	BMW X3 Std 1 Dwr, dimensions: 32L x 38W	\$1,895.00	\$1,622.92
336320	TruckVault Inc.	T-BWX3NS1-11N	BMW X3 Std 1 Dwr, dimensions: 29L x 42W	\$1,895.00	\$1,622.92
336320	TruckVault Inc.	T-BWX3NS1-18N	X3 Std 1 Dwr	\$1,895.00	\$1,622.92
336320	TruckVault Inc.	T-BWX3NS2-04N	X3 Std 2 Dwr	\$2,445.00	\$2,093.95
336320	TruckVault Inc.	T-BWX3NS2-11N	BMW X3 Std 2 Dwr, dimensions: 29L x 42W	\$2,445.00	\$2,093.95
336320	TruckVault Inc.	T-BWX3NSO-04N-PT	BMW X3 Std Offset, dimensions: 0L x 0W	\$3,140.00	\$2,689.17
336320	TruckVault Inc.	T-BWX3NU1-11N	X3 Utility1 Dwr	\$1,925.00	\$1,648.61
336320	TruckVault Inc.	T-BWX3NUO-18N	X3 Utility Offset	\$2,545.00	\$2,179.60
336320	TruckVault Inc.	T-BWX5NM1-00N	BMW X5 Mag 1 Dwr, dimensions: 27.5L x 42W	\$2,095.00	\$1,794.21
336320	TruckVault Inc.	T-BWX5NM1-07N	BMW X5 Mag 1 Dwr, dimensions: 32L x 38W	\$2,095.00	\$1,794.21
336320	TruckVault Inc.	T-BWX5NM1-14N	X5 Mag 1 Dwr	\$2,095.00	\$1,794.21
336320	TruckVault Inc.	T-BWX5NM1-14N-TT-ZC8172	X5 Mag 1 Dwr w/Top Tray	\$2,705.00	\$2,316.62
336320	TruckVault Inc.	T-BWX5NM2-00N	BMW X5 Mag 2 Dwr, dimensions: 27.5L x 42W	\$2,215.00	\$1,896.98
336320	TruckVault Inc.	T-BWX5NM2-07N	X5 Mag 2 Dwr	\$2,645.00	\$2,265.24
336320	TruckVault Inc.	T-BWX5NMO-07N	BMW X5 Mag OS Dwr, dimensions: 32L x 38W	\$2,645.00	\$2,265.24
336320	TruckVault Inc.	T-BWX5NN1-14N-ZC10109	X5 Custom 1 Dwr	\$1,595.00	\$1,365.99
336320	TruckVault Inc.	T-BWX5NS1-00N	BMW X5 Std 1 Dwr, dimensions: 29.5L x 42W	\$1,895.00	\$1,622.92
336320	TruckVault Inc.	T-BWX5NS1-07N	BMW X5 Std 1 Dwr, dimensions: 34L x 38W	\$1,895.00	\$1,622.92
336320	TruckVault Inc.	T-BWX5NS1-14N	BMW X5 Std 1 Dwr, dimensions: 35L x 37W	\$1,895.00	\$1,622.92
336320	TruckVault Inc.	T-BWX5NS1-14N-PT	X5 Std 1 Dwr	\$2,590.00	\$2,218.14
336320	TruckVault Inc.	T-BWX5NS1-14N-TT	X5 Std 1 Dwr	\$2,390.00	\$2,046.85
336320	TruckVault Inc.	T-BWX5NS1-14N-TT-ZC9444	X5 Std 1 DwrTop Tray	\$2,295.00	\$1,965.49
336320	TruckVault Inc.	T-BWX5NS2-00N	BMW X5 Std 2 Dwr, dimensions: 27.5L x 42W	\$2,445.00	\$2,093.95
336320	TruckVault Inc.	T-BWX5NS2-07N	BMW X5 Std 2 Dwr, dimensions: 34L x 38W	\$2,445.00	\$2,093.95
336320	TruckVault Inc.	T-BWX5NS2-14N	X5 Std 2 Dwr	\$2,445.00	\$2,093.95
336320	TruckVault Inc.	T-BWX5NSO-00N	BMW X5 Std Offset Dwr, dimensions: 27.5L x 42W	\$2,445.00	\$2,093.95
336320	TruckVault Inc.	T-BWX5NSO-07N	BMW X5 Std Offset Dwrs, dimensions: 34L x 38W	\$2,445.00	\$2,093.95
336320	TruckVault Inc.	T-BWX5NSO-14N	BMW X5 Std Offset Dwrs, dimensions: 35L x 37W	\$2,445.00	\$2,093.95
336320	TruckVault Inc.	T-BWX5NU1-07N	X5 Utility 1 Dwr	\$1,995.00	\$1,708.56
336320	TruckVault Inc.	T-BWX5NU1-14N	X5 Utility 1 Dwr	\$1,995.00	\$1,708.56
336320	TruckVault Inc.	T-BWX5NUO-14N	X5 Utility Offset Dwrs	\$2,545.00	\$2,179.60
336320	TruckVault Inc.	T-BWX6NM1-09N	X6 Mag 1 Dwr	\$1,995.00	\$1,708.56
336320	TruckVault Inc.	T-BWX6NM2-09N	X6 Mag 2 Dwr	\$2,545.00	\$2,179.60
336320	TruckVault Inc.	T-BWX6NS1-09N	X6 Std 1 Dwr	\$1,775.00	\$1,520.15
336320	TruckVault Inc.	T-BWX6NS2-09N	X6 Std 2 Dwr	\$2,325.00	\$1,991.18
336320	TruckVault Inc.	T-BWX7NM1-19S	X7 Mag 1 Dwr	\$1,895.00	\$1,622.92
336320	TruckVault Inc.	T-BWX7NS1-19S	X7 Std 1 Drawer	\$1,695.00	\$1,451.64
336320	TruckVault Inc.	T-BWX7NU1-19S-TF	X7 Utility1 Drawer3rd seat folded	\$2,195.00	\$1,879.85
336320	TruckVault Inc.	T-BWX7NU1-19S-TF-HT	X7 Utility1 Drawer3rd seat folded HD Table	\$2,690.00	\$2,303.78
336320	TruckVault Inc.	T-CADEFN1-18N-PW-ZC8730	Defender Cust 1 Dwr	\$3,105.00	\$2,659.19
336320	TruckVault Inc.	T-CAESCM1-00N	Cadillac Escalade Mag 1 Dwr, dimensions: 43L x 47W	\$2,295.00	\$1,965.49
336320	TruckVault Inc.	T-CAESCM1-00N-PT	Cadillac Escalade Mag 1 Dwr, dimensions: 43L x 47W	\$2,990.00	\$2,560.71
336320	TruckVault Inc.	T-CAESCM1-07N	Cadillac Escalade Mag 1 Dwr, dimensions: 38L x 48W	\$2,295.00	\$1,965.49
336320	TruckVault Inc.	T-CAESCM1-07N-PP	Cadillac Escalade Mag 1 Dwr, dimensions: 35L x 48W	\$2,095.00	\$1,794.21
336320	TruckVault Inc.	T-CAESCM1-12N	Cadillac Escalade Mag 1 Dwr, dimensions: 38L x 48W	\$2,295.00	\$1,965.49
336320	TruckVault Inc.	T-CAESCM1-15N	Cadillac Escalade Mag 1 Dwr, dimensions: 38L x 48W	\$2,295.00	\$1,965.49
336320	TruckVault Inc.	T-CAESCM1-15N-CR	Cadillac Escalade Mag 1 Dwr, dimensions: 38L x 48W	\$2,645.00	\$2,265.24
336320	TruckVault Inc.	T-CAESCM1-15N-HD-HT	Escalade Mag 1 Dwr 1/2 WidthTray/3rd Removed HD Table	\$2,755.00	\$2,359.45
336320	TruckVault Inc.	T-CAESCM2-00N	Cadillac Escalade Mag 2 Dwr, dimensions: 43L x 47W	\$2,845.00	\$2,436.52
336320	TruckVault Inc.	T-CAESCM2-00N-PP-LN	Cadillac Escalade Mag 2 Dwr, dimensions: 40L x 48W	\$2,845.00	\$2,436.52
336320	TruckVault Inc.	T-CAESCM2-00N-TC-LN	Cadillac Escalade Mag 2 Dwr, dimensions: 40L x 48W	\$2,845.00	\$2,436.52
336320	TruckVault Inc.	T-CAESCM2-07N	Cadillac Escalade Mag 2 Dwr, dimensions: 38L x 48W	\$2,845.00	\$2,436.52
336320	TruckVault Inc.	T-CAESCM2-12N	Cadillac Escalade Mag 2 Dwr, dimensions: 38L x 48W	\$2,845.00	\$2,436.52
336320	TruckVault Inc.	T-CAESCM2-12N-PP	Cadillac Escalade Mag 2 Dwr, dimensions: 35L x 48W	\$2,645.00	\$2,265.24
336320	TruckVault Inc.	T-CAESCM2-15N	Cadillac Escalade Mag 2 Dwr, dimensions: 38L x 48W	\$2,845.00	\$2,436.52
336320	TruckVault Inc.	T-CAESCM2-15N-CR	Cadillac Escalade Mag 2 Dwr, dimensions: 35L x 48W	\$2,995.00	\$2,564.99
336320	TruckVault Inc.	T-CAESCM2-97N	Cadillac Escalade Mag 2 Dwr, dimensions: 43L x 48W	\$2,845.00	\$2,436.52
336320	TruckVault Inc.	T-CAESCMO-00N	Cadillac Escalade Mag OS Dwr, dimensions: 43L x 47W	\$2,845.00	\$2,436.52
336320	TruckVault Inc.	T-CAESCMO-07N	Cadillac Escalade Mag OS Dwr, dimensions: 38L x 48W	\$2,845.00	\$2,436.52
336320	TruckVault Inc.	T-CAESCMO-12N	Cadillac Escalade Mag OS Dwr, dimensions: 38L x 48W	\$2,845.00	\$2,436.52
336320	TruckVault Inc.	T-CAESCMO-15N	Cadillac Escalade Mag OS Dwr, dimensions: 38L x 48W	\$2,845.00	\$2,436.52

336320	TruckVault Inc.	T-CAESCNO-07N-HT-ZC9061	Escalade Custom 2 Drawer	\$3,725.00	\$3,190.18
336320	TruckVault Inc.	T-CAESCS1-00N	Cadillac Escalade Std 1 Dwr, dimensions: 45L x 48W	\$2,095.00	\$1,794.21
336320	TruckVault Inc.	T-CAESCS1-00N-PP	Cadillac Escalade Std 1 Dwr, dimensions: 42L x 48W	\$2,095.00	\$1,794.21
336320	TruckVault Inc.	T-CAESCS1-00N-TC	Cadillac Escalade Std 1 Dwr, dimensions: 42L x 48W	\$2,095.00	\$1,794.21
336320	TruckVault Inc.	T-CAESCS1-07N	Cadillac Escalade Std 1 Dwr, dimensions: 39L x 48W	\$2,095.00	\$1,794.21
336320	TruckVault Inc.	T-CAESCS1-07N-PT	Cadillac Escalade Std 1 Dwr, dimensions: 39L x 48W	\$2,790.00	\$2,389.42
336320	TruckVault Inc.	T-CAESCS1-12N	Cadillac Escalade Std 1 Dwr, dimensions: 39L x 48W	\$2,095.00	\$1,794.21
336320	TruckVault Inc.	T-CAESCS1-12N-PP	Cadillac Escalade Std 1 Dwr, dimensions: 35L x 48W	\$1,895.00	\$1,622.92
336320	TruckVault Inc.	T-CAESCS1-12N-PT	Cadillac Escalade Std 1 Dwr, dimensions: 38L x 48W	\$2,790.00	\$2,389.42
336320	TruckVault Inc.	T-CAESCS1-15N	Cadillac Escalade Std 1 Dwr, dimensions: 39L x 48W	\$2,095.00	\$1,794.21
336320	TruckVault Inc.	T-CAESCS1-15N-CR	Cadillac Escalade Std 1 Dwr, dimensions: 39L x 48W	\$2,445.00	\$2,093.95
336320	TruckVault Inc.	T-CAESCS1-15N-HD-CR	Escalade Std 1 Dwr 1/2 Width driver's side3rd Row Folded; Tray Removed	\$1,995.00	\$1,708.56
336320	TruckVault Inc.	T-CAESCS1-15N-HT-CR	Escalade Std 1 Dwr3rd Row Folded; Tray Removed; Heavy Duty Table	\$3,140.00	\$2,689.17
336320	TruckVault Inc.	T-CAESCS1-15N-PT	Cadillac Escalade Std 1 Dwr, dimensions: 38L x 48W	\$2,790.00	\$2,389.42
336320	TruckVault Inc.	T-CAESCS1-15N-PT-CR	Escalade Std 1 Dwr Pull Out Table3rd Row Folded; Tray Removed	\$3,140.00	\$2,689.17
336320	TruckVault Inc.	T-CAESCS1-15N-TT	Cadillac Escalade Std 1 Dwr, dimensions: 39L x 48W	\$3,090.00	\$2,646.35
336320	TruckVault Inc.	T-CAESCS1-97N	Cadillac Escalade Std 1 Dwr, dimensions: 45.5L x 48W	\$2,095.00	\$1,794.21
336320	TruckVault Inc.	T-CAESCS2-00N	Cadillac Escalade Std 2 Dwr, dimensions: 45L x 48W	\$2,645.00	\$2,265.24
336320	TruckVault Inc.	T-CAESCS2-07N	Cadillac Escalade Std 2 Dwr, dimensions: 39L x 48W	\$2,645.00	\$2,265.24
336320	TruckVault Inc.	T-CAESCS2-07N-PP	Cadillac Escalade Std 2 Dwr, dimensions: 36L x 48W	\$2,645.00	\$2,265.24
336320	TruckVault Inc.	T-CAESCS2-12N	Cadillac Escalade Std 2 Dwr, dimensions: 39L x 48W	\$2,645.00	\$2,265.24
336320	TruckVault Inc.	T-CAESCS2-15N	Cadillac Escalade Std 2 Dwr, dimensions: 39L x 48W	\$2,645.00	\$2,265.24
336320	TruckVault Inc.	T-CAESCS2-15N-HT	Escalade Std 2 Dwr	\$3,340.00	\$2,860.45
336320	TruckVault Inc.	T-CAESCS2-21N-TR	Escalade Std 2 Dwr	\$2,645.00	\$2,265.24
336320	TruckVault Inc.	T-CAESCSO-00N	Cadillac Escalade Std OS Dwr, dimensions: 45L x 48W	\$2,645.00	\$2,265.24
336320	TruckVault Inc.	T-CAESCSO-00N-LN	Cadillac Escalade Std OS Dwr, dimensions: 45L x 48W	\$2,645.00	\$2,265.24
336320	TruckVault Inc.	T-CAESCSO-07N	Cadillac Escalade Std OS Dwr, dimensions: 39L x 48W	\$2,645.00	\$2,265.24
336320	TruckVault Inc.	T-CAESCSO-07N-PT	Cadillac Escalade Std OS Dwr, dimensions: 39L x 48W	\$3,340.00	\$2,860.45
336320	TruckVault Inc.	T-CAESCSO-12N	Cadillac Escalade Std OS Dwr, dimensions: 39L x 48W	\$2,645.00	\$2,265.24
336320	TruckVault Inc.	T-CAESCSO-15N	Cadillac Escalade Std OS Dwr, dimensions: 39L x 48W	\$2,645.00	\$2,265.24
336320	TruckVault Inc.	T-CAESCSO-15N-CR	Escalade Std OS Dwr	\$2,795.00	\$2,393.70
336320	TruckVault Inc.	T-CAESVM1-03S	Cadillac Escalade ESV Mag 1 Dwr, dimensions: 30L x 48W	\$2,095.00	\$1,794.21
336320	TruckVault Inc.	T-CAESVM1-07S	Cadillac Escalade ESV Mag 1 Dwr, dimensions: 29L x 48W	\$2,095.00	\$1,794.21
336320	TruckVault Inc.	T-CAESVM1-12S	Cadillac Escalade ESV Mag 1 Dwr, dimensions: 28L x 48W	\$2,095.00	\$1,794.21
336320	TruckVault Inc.	T-CAESVM1-15S	Cadillac Escalade ESV Mag 1 Dwr, dimensions: 28L x 48W	\$2,095.00	\$1,794.21
336320	TruckVault Inc.	T-CAESVM2-03F	Cadillac Escalade ESV Mag 2 Dwr, dimensions: 62.5L x 48W	\$3,245.00	\$2,779.09
336320	TruckVault Inc.	T-CAESVM2-03F-LN	Cadillac Escalade ESV Mag 2 Dwr, dimensions: 62.5L x 48W	\$3,245.00	\$2,779.09
336320	TruckVault Inc.	T-CAESVM2-03F-TC	Cadillac Escalade ESV Mag 2 Dwr, dimensions: 59.5L x 48W	\$3,045.00	\$2,607.81
336320	TruckVault Inc.	T-CAESVM2-03F-TC-LN	Cadillac Escalade ESV Mag 2 Dwr, dimensions: 59.5L x 48W	\$3,045.00	\$2,607.81
336320	TruckVault Inc.	T-CAESVM2-03M	Cadillac Escalade ESV Mag 2 Dwr, dimensions: 54L x 48W	\$3,045.00	\$2,607.81
336320	TruckVault Inc.	T-CAESVM2-03M-LN	Cadillac Escalade ESV Mag 2 Dwr, dimensions: 54L x 48W	\$3,045.00	\$2,607.81
336320	TruckVault Inc.	T-CAESVM2-03S	Cadillac Escalade ESV Mag 2 Dwr, dimensions: 30L x 48W	\$2,645.00	\$2,265.24
336320	TruckVault Inc.	T-CAESVM2-07F	Cadillac Escalade ESV Mag 2 Dwr, dimensions: 60L x 48W	\$3,245.00	\$2,779.09
336320	TruckVault Inc.	T-CAESVM2-07F-PT	Cadillac Escalade ESV Mag 2 Dwr, dimensions: 59L x 48W	\$3,740.00	\$3,203.02
336320	TruckVault Inc.	T-CAESVM2-07M	Cadillac Escalade ESV Mag 2 Dwr, dimensions: 52L x 48W	\$2,985.00	\$2,556.42
336320	TruckVault Inc.	T-CAESVM2-07S	Cadillac Escalade ESV Mag 2 Dwr, dimensions: 29L x 48W	\$2,645.00	\$2,265.24
336320	TruckVault Inc.	T-CAESVM2-07S-PT	Escalade ESV Mag 2 Dwr	\$3,340.00	\$2,860.45
336320	TruckVault Inc.	T-CAESVM2-12F	Cadillac Escalade ESV Mag 2 Dwr, dimensions: 60L x 48W	\$3,245.00	\$2,779.09
336320	TruckVault Inc.	T-CAESVM2-12M	Cadillac Escalade ESV Mag 2 Dwr, dimensions: 52L x 48W	\$2,985.00	\$2,556.42
336320	TruckVault Inc.	T-CAESVM2-12S	Cadillac Escalade ESV Mag 2 Dwr, dimensions: 28L x 48W	\$2,645.00	\$2,265.24
336320	TruckVault Inc.	T-CAESVM2-15F	Cadillac Escalade ESV Mag 2 Dwr, dimensions: 60L x 48W	\$3,245.00	\$2,779.09
336320	TruckVault Inc.	T-CAESVM2-15M	Cadillac Escalade ESV Mag 2 Dwr, dimensions: 52L x 48W	\$2,985.00	\$2,556.42
336320	TruckVault Inc.	T-CAESVM2-15S	Cadillac Escalade ESV Mag 2 Dwr, dimensions: 29L x 48W	\$2,645.00	\$2,265.24
336320	TruckVault Inc.	T-CAESVMO-00F-TC	Cadillac Escalade ESV Mag OS Dwr, dimensions: 59.5L x 48W	\$3,045.00	\$2,607.81
336320	TruckVault Inc.	T-CAESVMO-03F	Cadillac Escalade ESV Mag OS Dwr, dimensions: 62.5L x 48W	\$3,245.00	\$2,779.09
336320	TruckVault Inc.	T-CAESVMO-03F-LN	Cadillac Escalade ESV Mag OS Dwr, dimensions: 62.5L x 48W	\$3,245.00	\$2,779.09
336320	TruckVault Inc.	T-CAESVMO-03F-TC	Cadillac Escalade ESV Mag OS Dwr, dimensions: 59.5L x 48W	\$3,045.00	\$2,607.81
336320	TruckVault Inc.	T-CAESVMO-03F-TC-LN	Cadillac Escalade ESV Mag OS Dwr, dimensions: 59.5L x 48W	\$3,045.00	\$2,607.81
336320	TruckVault Inc.	T-CAESVMO-03M	Cadillac Escalade ESV Mag OS Dwr, dimensions: 54L x 48W	\$3,045.00	\$2,607.81
336320	TruckVault Inc.	T-CAESVMO-03M-LN	Cadillac Escalade ESV Mag OS Dwr, dimensions: 54L x 48W	\$3,045.00	\$2,607.81
336320	TruckVault Inc.	T-CAESVMO-03S	Cadillac Escalade ESV Mag OS Dwr, dimensions: 30L x 48W	\$2,645.00	\$2,265.24
336320	TruckVault Inc.	T-CAESVMO-07F	Cadillac Escalade ESV Mag OS Dwr, dimensions: 60L x 48W	\$3,245.00	\$2,779.09
336320	TruckVault Inc.	T-CAESVMO-07M	Cadillac Escalade ESV Mag OS Dwr, dimensions: 52L x 48W	\$2,985.00	\$2,556.42
336320	TruckVault Inc.	T-CAESVMO-07S	Cadillac Escalade ESV Mag OS Dwr, dimensions: 29L x 48W	\$2,645.00	\$2,265.24
336320	TruckVault Inc.	T-CAESVMO-12F	Cadillac Escalade ESV Mag OS Dwr, dimensions: 60L x 48W	\$3,245.00	\$2,779.09
336320	TruckVault Inc.	T-CAESVMO-12F-PT	Escalade ESV Mag OS Dwr	\$3,740.00	\$3,203.02
336320	TruckVault Inc.	T-CAESVMO-12M	Cadillac Escalade ESV Mag OS Dwr, dimensions: 52L x 48W	\$2,985.00	\$2,556.42

336320	TruckVault Inc.	T-CAESVMO-12S	Cadillac Escalade ESV Mag OS Dwr, dimensions: 28L x 48W	\$2,645.00	\$2,265.24
336320	TruckVault Inc.	T-CAESVMO-15F-PT	Escalade ESV Mag OS Dwr	\$3,685.00	\$3,155.92
336320	TruckVault Inc.	T-CAESVS1-03M	Cadillac Escalade ESV Std 1 Dwr, dimensions: 52L x 48W	\$2,215.00	\$1,896.98
336320	TruckVault Inc.	T-CAESVS1-03S	Cadillac Escalade ESV Std 1 Dwr, dimensions: 30L x 48W	\$1,895.00	\$1,622.92
336320	TruckVault Inc.	T-CAESVS1-07S	Cadillac Escalade ESV Std 1 Dwr, dimensions: 28L x 48W	\$1,895.00	\$1,622.92
336320	TruckVault Inc.	T-CAESVS1-07S-PT	Cadillac Escalade ESV Std 1 Dwr, dimensions: 27L x 48W	\$2,590.00	\$2,218.14
336320	TruckVault Inc.	T-CAESVS1-12S	Cadillac Escalade ESV Std 1 Dwr, dimensions: 28L x 48W	\$1,895.00	\$1,622.92
336320	TruckVault Inc.	T-CAESVS1-15M-CR	Escalade ESV Std 1 Dwr	\$2,605.00	\$2,230.98
336320	TruckVault Inc.	T-CAESVS1-15S	Cadillac Escalade ESV Std 1 Dwr, dimensions: 28L x 48W	\$1,895.00	\$1,622.92
336320	TruckVault Inc.	T-CAESVS1-15S-HT	Escalade ESV Std 1 DwrS-Size, Tray Removed HD Table	\$2,590.00	\$2,218.14
336320	TruckVault Inc.	T-CAESVS1-15S-HT-TF	Escalade ESV Std 1 Dwr, S-Size,Tray Removed, HD Table Seat Folded	\$2,590.00	\$2,218.14
336320	TruckVault Inc.	T-CAESVS2-03F	Cadillac Escalade ESV Std 2 Dwr, dimensions: 62.5L x 48W	\$2,985.00	\$2,556.42
336320	TruckVault Inc.	T-CAESVS2-03F-LN	Cadillac Escalade ESV Std 2 Dwr, dimensions: 62.5L x 48W	\$2,985.00	\$2,556.42
336320	TruckVault Inc.	T-CAESVS2-03M	Cadillac Escalade ESV Std 2 Dwr, dimensions: 54L x 48W	\$2,845.00	\$2,436.52
336320	TruckVault Inc.	T-CAESVS2-03M-LN	Cadillac Escalade ESV Std 2 Dwr, dimensions: 54L x 48W	\$2,845.00	\$2,436.52
336320	TruckVault Inc.	T-CAESVS2-03M-PT	Cadillac Escalade ESV Std 2 Dwr, dimensions: 52L x 48W	\$3,465.00	\$2,967.51
336320	TruckVault Inc.	T-CAESVS2-03S	Cadillac Escalade ESV Std 2 Dwr, dimensions: 30L x 48W	\$2,445.00	\$2,093.95
336320	TruckVault Inc.	T-CAESVS2-07F	Cadillac Escalade ESV Std 2 Dwr, dimensions: 60L x 48W	\$2,985.00	\$2,556.42
336320	TruckVault Inc.	T-CAESVS2-07F-PT	Cadillac Escalade ESV Std 2 Dwr, dimensions: 60L x 48W	\$3,685.00	\$3,155.92
336320	TruckVault Inc.	T-CAESVS2-07M	Cadillac Escalade ESV Std 2 Dwr, dimensions: 52L x 48W	\$2,755.00	\$2,359.45
336320	TruckVault Inc.	T-CAESVS2-07S	Cadillac Escalade ESV Std 2 Dwr, dimensions: 28L x 48W	\$2,445.00	\$2,093.95
336320	TruckVault Inc.	T-CAESVS2-12F	Cadillac Escalade ESV Std 2 Dwr, dimensions: 60L x 48W	\$2,985.00	\$2,556.42
336320	TruckVault Inc.	T-CAESVS2-12M	Cadillac Escalade ESV Std 2 Dwr, dimensions: 52L x 48W	\$2,755.00	\$2,359.45
336320	TruckVault Inc.	T-CAESVS2-12S	Cadillac Escalade ESV Std 2 Dwr, dimensions: 28L x 48W	\$2,445.00	\$2,093.95
336320	TruckVault Inc.	T-CAESVS2-15F	Cadillac Escalade ESV Std 2 Dwr, dimensions: 60L x 48W	\$2,985.00	\$2,556.42
336320	TruckVault Inc.	T-CAESVS2-15F-CR	Cadillac Escalade Std 2 Dwr, dimensions: 58L x 48W	\$3,195.00	\$2,736.27
336320	TruckVault Inc.	T-CAESVS2-15M	Cadillac Escalade ESV Std 2 Dwr, dimensions: 52L x 48W	\$2,755.00	\$2,359.45
336320	TruckVault Inc.	T-CAESVS2-15M-CR	Escalade ESV Std 2 Dwr	\$3,195.00	\$2,736.27
336320	TruckVault Inc.	T-CAESVS2-15S	Cadillac Escalade ESV Std 2 Dwr, dimensions: 28L x 48W	\$2,445.00	\$2,093.95
336320	TruckVault Inc.	T-CAESVS2-03F	Cadillac Escalade ESV Std OS Dwr, dimensions: 62.5L x 48W	\$2,985.00	\$2,556.42
336320	TruckVault Inc.	T-CAESVSO-03F-LN	Cadillac Escalade ESV Std OS Dwr, dimensions: 62.5L x 48W	\$2,985.00	\$2,556.42
336320	TruckVault Inc.	T-CAESVSO-03M	Cadillac Escalade ESV Std OS Dwr, dimensions: 54L x 48W	\$2,845.00	\$2,436.52
336320	TruckVault Inc.	T-CAESVSO-03M-LN	Cadillac Escalade ESV Std OS Dwr, dimensions: 54L x 48W	\$2,845.00	\$2,436.52
336320	TruckVault Inc.	T-CAESVSO-03S	Cadillac Escalade ESV Std OS Dwr, dimensions: 30L x 48W	\$2,445.00	\$2,093.95
336320	TruckVault Inc.	T-CAESVSO-07F	Cadillac Escalade ESV Std OS Dwr, dimensions: 60L x 48W	\$2,985.00	\$2,556.42
336320	TruckVault Inc.	T-CAESVSO-07M	Cadillac Escalade ESV Std OS Dwr, dimensions: 52L x 48W	\$2,755.00	\$2,359.45
336320	TruckVault Inc.	T-CAESVSO-07M-PT	Cadillac Escalade ESV Std OS Dwr, dimensions: 52L x 48W	\$3,465.00	\$2,967.51
336320	TruckVault Inc.	T-CAESVSO-07S	Cadillac Escalade ESV Std OS Dwr, dimensions: 28L x 48W	\$2,445.00	\$2,093.95
336320	TruckVault Inc.	T-CAESVSO-12F	Cadillac Escalade ESV Std OS Dwr, dimensions: 60L x 48W	\$2,985.00	\$2,556.42
336320	TruckVault Inc.	T-CAESVSO-12M	Cadillac Escalade ESV Std OS Dwr, dimensions: 52L x 48W	\$2,755.00	\$2,359.45
336320	TruckVault Inc.	T-CAESVSO-12S	Cadillac Escalade ESV Std OS Dwr, dimensions: 28L x 48W	\$1,995.00	\$1,708.56
336320	TruckVault Inc.	T-CAESVSO-15F	Escalade ESV Std OS Dwr	\$2,985.00	\$2,556.42
336320	TruckVault Inc.	T-CAESVSO-15S-TT	Escalade ESV Std OS Dwr	\$3,290.00	\$2,817.63
336320	TruckVault Inc.	T-CAESVU2-07F	Escalade ESV Utility 2 Dwr	\$3,095.00	\$2,650.63
336320	TruckVault Inc.	T-CAESVUO-07F	Escalade ESV Utility OS Dwr	\$3,095.00	\$2,650.63
336320	TruckVault Inc.	T-CAEXTM2-02S	Cadillac Escalade EXT Mag 2 Dwr, dimensions: 61L x 48W	\$3,245.00	\$2,779.09
336320	TruckVault Inc.	T-CAEXTM2-02S-PW	Cadillac Escalade EXT Mag 2 Dwr, dimensions: 61L x 48W	\$3,975.00	\$3,404.28
336320	TruckVault Inc.	T-CAEXTMO-02S	Cadillac Escalade EXT Mag OS Dwr, dimensions: 61L x 48W	\$3,245.00	\$2,779.09
336320	TruckVault Inc.	T-CAEXTS2-02S	Cadillac Escalade EXT Std 2 Dwr, dimensions: 61L x 48W	\$2,985.00	\$2,556.42
336320	TruckVault Inc.	T-CAEXTS2-02S-PW	Cadillac Escalade EXT Std 2 Dwr, dimensions: 61L x 48W	\$3,755.00	\$3,215.87
336320	TruckVault Inc.	T-CAEXTSO-02S	Cadillac Escalade EXT Std OS Dwr, dimensions: 61L x 48W	\$2,985.00	\$2,556.42
336320	TruckVault Inc.	T-CAEXTSO-02S-PW	Cadillac Escalade EXT Std OS Dwr, dimensions: 61L x 48W	\$3,755.00	\$3,215.87
336320	TruckVault Inc.	T-CASRXM1-04N	Cadillac SRX Mag 1 Dwr, dimensions: 36L x 35W	\$2,095.00	\$1,794.21
336320	TruckVault Inc.	T-CASRXM1-10N	Cadillac SRX Mag 1 Dwr, dimensions: 0L x 0W	\$2,095.00	\$1,794.21
336320	TruckVault Inc.	T-CASRXM2-04N	Cadillac SRX Mag 2 Dwr, dimensions: 36L x 35W	\$2,645.00	\$2,265.24
336320	TruckVault Inc.	T-CASRXM2-10N	Cadillac SRX Mag 2 Dwr, dimensions: 0L x 0W	\$2,645.00	\$2,265.24
336320	TruckVault Inc.	T-CASRXS1-04N	Cadillac SRX Std 1 Dwr, dimensions: 0L x 0W	\$1,895.00	\$1,622.92
336320	TruckVault Inc.	T-CASRXS1-10N	Cadillac SRX Std 1 Dwr, dimensions: 34L x 37W	\$1,895.00	\$1,622.92
336320	TruckVault Inc.	T-CASRXS2-04N	Cadillac SRX Std 2 Dwr, dimensions: 0L x 0W	\$2,445.00	\$2,093.95
336320	TruckVault Inc.	T-CASRXS2-10N	Cadillac SRX Std 2 Dwr, dimensions: 37L x 30W	\$2,445.00	\$2,093.95
336320	TruckVault Inc.	T-CAXT5M1-17N	XT5 Mag 1 Dwr	\$2,095.00	\$1,794.21
336320	TruckVault Inc.	T-CAXT5S1-17N	XT5 Std 1 Dwr	\$1,895.00	\$1,622.92
336320	TruckVault Inc.	T-CAXT5S2-17N	XT5 Std 2 Dwr	\$2,445.00	\$2,093.95
336320	TruckVault Inc.	T-CAXT6N1-17N-C1-TT-Z1	XT6 Custom 1 Dwr	\$3,195.00	\$2,736.27
336320	TruckVault Inc.	T-CHASTM1-95L	Chevrolet Astro Van Mag 1 Dwr, dimensions: 51L x 48W	\$2,435.00	\$2,085.39
336320	TruckVault Inc.	T-CHASTM2-95L	Chevrolet Astro Van Mag 2 Dwr, dimensions: 54L x 48W	\$3,045.00	\$2,607.81
336320	TruckVault Inc.	T-CHASTMO-95L	Chevrolet Astro Van Mag OS Dwr, dimensions: 54L x 48W	\$3,045.00	\$2,607.81

336320	TruckVault Inc.	T-CHASTS1-95L	Chevrolet Astro Van Std 1 Dwr, dimensions: 51L x 48W	\$2,215.00	\$1,896.98
336320	TruckVault Inc.	T-CHASTS2-95L	Chevrolet Astro Van Std 2 Dwr, dimensions: 54L x 48W	\$2,845.00	\$2,436.52
336320	TruckVault Inc.	T-CHASTSO-95L	Chevrolet Astro Van Std OS Dwr, dimensions: 54L x 48W	\$2,845.00	\$2,436.52
336320	TruckVault Inc.	T-CHAVLM1-02S-HD	Chevrolet Avalanche SUT Mag 1 Dwr, dimensions: 61L x 24W	\$2,105.00	\$1,802.77
336320	TruckVault Inc.	T-CHAVLM1-02S-HD-PW	Avalanche Mag 1 Dwr Half Width	\$2,745.00	\$2,350.88
336320	TruckVault Inc.	T-CHAVLM2-02S	Chevrolet Avalanche SUT Mag 2 Dwr, dimensions: 61L x 48W	\$3,205.00	\$2,744.84
336320	TruckVault Inc.	T-CHAVLM2-02S-PT	Chevrolet Avalanche SUT Mag 2 Dwr, dimensions: 61L x 48W	\$3,905.00	\$3,344.33
336320	TruckVault Inc.	T-CHAVLM2-02S-PW	Chevrolet Avalanche SUT Mag 2 Dwr, dimensions: 61L x 48W	\$3,975.00	\$3,404.28
336320	TruckVault Inc.	T-CHAVLMO-02S	Chevrolet Avalanche SUT Mag OS Dwr, dimensions: 61L x 48W	\$3,205.00	\$2,744.84
336320	TruckVault Inc.	T-CHAVLMO-02S-PW	Chevrolet Avalanche SUT Mag Offset Dwr, dimensions: 61L x 48W	\$3,975.00	\$3,404.28
336320	TruckVault Inc.	T-CHAVLS1-02S-HP	Avalanche SUT Std 1 Dwr	\$1,725.00	\$1,477.33
336320	TruckVault Inc.	T-CHAVLS2-02S	Chevrolet Avalanche SUT Std 2 Dwr, dimensions: 61L x 48W	\$2,985.00	\$2,556.42
336320	TruckVault Inc.	T-CHAVLS2-02S-PW	Chevrolet Avalanche SUT Std 2 Dwr, dimensions: 61L x 48W	\$3,755.00	\$3,215.87
336320	TruckVault Inc.	T-CHAVLSO-02S	Chevrolet Avalanche SUT Std Offset Dwr, dimensions: 61L x 48W	\$2,985.00	\$2,556.42
336320	TruckVault Inc.	T-CHAVLSO-02S-PW	Chevrolet Avalanche SUT Std OS Dwr, dimensions: 61L x 48W	\$3,755.00	\$3,215.87
336320	TruckVault Inc.	T-CHBLAM1-19N	Blazer Mag 1 Dwr	\$2,025.00	\$1,734.26
336320	TruckVault Inc.	T-CHBLAM2-19N	Blazer Full Size Mag 2 Dwr	\$2,645.00	\$2,265.24
336320	TruckVault Inc.	T-CHBLAM2-73N	Chevrolet Blazer Full Size Mag 2 Dwr, dimensions: 32L x 48W	\$2,515.00	\$2,153.90
336320	TruckVault Inc.	T-CHBLAM2-92N	Chevrolet Blazer Full Size Mag 2 Dwr, dimensions: 35L x 48W	\$2,645.00	\$2,265.24
336320	TruckVault Inc.	T-CHBLAM2-92N-HT	Blazer Full Size Mag 2 Dwr	\$3,340.00	\$2,860.45
336320	TruckVault Inc.	T-CHBLAMO-92N	Chevrolet Blazer Full Size Mag Offset, dimensions: 33L x 34.375W	\$2,445.00	\$2,093.95
336320	TruckVault Inc.	T-CHBLAMO-92N-PT	Chevrolet Blazer Full Size Mag Offset, dimensions: 33L x 34.875W	\$3,135.00	\$2,684.89
336320	TruckVault Inc.	T-CHBLAS1-19N	Blazer Std 1 Dwr	\$1,895.00	\$1,622.92
336320	TruckVault Inc.	T-CHBLAS1-90N	Chevrolet Blazer Full Size Std 1 Dwr, dimensions: 0L x 0W	\$1,895.00	\$1,622.92
336320	TruckVault Inc.	T-CHBLAS1-92N	Chevrolet Blazer Full Size Std 1 Dwr, dimensions: 34L x 34.875W	\$1,695.00	\$1,451.64
336320	TruckVault Inc.	T-CHBLAS2-19N	Blazer Full Size Std 2 Dwr	\$2,445.00	\$2,093.95
336320	TruckVault Inc.	T-CHBLAS2-73N	Chevrolet Blazer Full Size Std 2 Dwr, dimensions: 34L x 48W	\$2,445.00	\$2,093.95
336320	TruckVault Inc.	T-CHBLAS2-73N-PW	Blazer Full Size Std 2 Dwr	\$2,545.00	\$2,179.60
336320	TruckVault Inc.	T-CHBLAS2-90N	Chevrolet Blazer Full Size Std 2 Dwr, dimensions: 0L x 0W	\$2,445.00	\$2,093.95
336320	TruckVault Inc.	T-CHBLAS2-92N	Chevrolet Blazer Full Size Std 2 Dwr, dimensions: 34L x 34.875W	\$2,245.00	\$1,922.67
336320	TruckVault Inc.	T-CHBOLL1-17N	Bolt EV Std 1 Dwr	\$1,195.00	\$1,023.43
336320	TruckVault Inc.	T-CHBOLM1-17N	Bolt EV Mag 1 Dwr	\$1,895.00	\$1,622.92
336320	TruckVault Inc.	T-CHBOLS1-17N	Bolt EV Std 1 Dwr	\$1,695.00	\$1,451.64
336320	TruckVault Inc.	T-CHCAPS1-11N	Chevrolet Captiva Std 1 Dwr, dimensions: 27L x 35W	\$1,695.00	\$1,451.64
336320	TruckVault Inc.	T-CHCEXM2-16N-ZC10594A	Express Van Mag 2 DwrLWB	\$4,665.00	\$3,995.21
336320	TruckVault Inc.	T-CHCOLM1-04S-PC-HP	Colorado Mag 1 Dwr Half Width	\$2,195.00	\$1,879.85
336320	TruckVault Inc.	T-CHCOLM1-15S-HP	Colorado Mag 1 Dwr Half Width	\$2,325.00	\$1,991.18
336320	TruckVault Inc.	T-CHCOLM1-15S-HP-PW	Colorado Pickup Mag 1 Dwr	\$2,645.00	\$2,265.24
336320	TruckVault Inc.	T-CHCOLM1-15S-PC-HP	Colorado Mag 1 Dwr Half Width	\$2,195.00	\$1,879.85
336320	TruckVault Inc.	T-CHCOLM1-15S-PC-HP-PW	Colorado Pickup Mag 1 Dwr	\$2,445.00	\$2,093.95
336320	TruckVault Inc.	T-CHCOLM2-04S-PC	Colorado Pickup Mag 2 Dwr	\$3,145.00	\$2,693.45
336320	TruckVault Inc.	T-CHCOLM2-04S-PC-PW	Chevrolet Colorado Pickup Mag 2 Dwr, dimensions: 59.75L x 42.25W	\$4,245.00	\$3,635.52
336320	TruckVault Inc.	T-CHCOLM2-04S-PW	Chevrolet Colorado Pickup Mag 2 Dwr, dimensions: 69L x 43.25W	\$4,245.00	\$3,635.52
336320	TruckVault Inc.	T-CHCOLM2-15S-PC	Colorado Pickup Mag 2 Dwr	\$3,145.00	\$2,693.45
336320	TruckVault Inc.	T-CHCOLM2-15S-PC-HT	Colorado Pickup Mag 2 Dwr	\$3,740.00	\$3,203.02
336320	TruckVault Inc.	T-CHCOLM2-15S-PC-PL	Colorado Pickup Mag 2 Dwr	\$3,145.00	\$2,693.45
336320	TruckVault Inc.	T-CHCOLM2-15S-PC-PW	Chevrolet Colorado Pickup Mag 2 Dwr, dimensions: 57.5L x 43W	\$3,945.00	\$3,378.59
336320	TruckVault Inc.	T-CHCOLM2-15S-PW	Chevrolet Colorado Pickup Mag 2 Dwr, dimensions: 70L x 43W	\$4,245.00	\$3,635.52
336320	TruckVault Inc.	T-CHCOLMO-04S-PC	Colorado Pickup Mag Offset	\$3,145.00	\$2,693.45
336320	TruckVault Inc.	T-CHCOLMO-04S-PC-PW	Chevrolet Colorado Pickup Mag OS Dwr, dimensions: 59.75L x 42.25W	\$3,945.00	\$3,378.59
336320	TruckVault Inc.	T-CHCOLMO-04S-PW	Chevrolet Colorado Pickup Mag Offset, dimensions: 69L x 43.25W	\$4,245.00	\$3,635.52
336320	TruckVault Inc.	T-CHCOLMO-15S	Colorado Pickup Mag Offset Dwr	\$3,345.00	\$2,864.74
336320	TruckVault Inc.	T-CHCOLMO-15S-PC	Colorado Pickup Mag OS Dwr	\$3,145.00	\$2,693.45
336320	TruckVault Inc.	T-CHCOLMO-15S-PC-PW	Colorado Pickup Mag Offset Dwr	\$3,945.00	\$3,378.59
336320	TruckVault Inc.	T-CHCOLMO-15S-PW	Chevrolet Colorado Pickup Mag OS Dwr, dimensions: 70L x 43W	\$4,245.00	\$3,635.52
336320	TruckVault Inc.	T-CHCOLN2-15S-PC-ZC10416	Colorado Pickup Mag 2 DwrShort Bed, Crew Cab	\$3,955.00	\$3,387.15
336320	TruckVault Inc.	T-CHCOLN2-15S-PC-ZC9018	Colorado Pickup Custom 2 Dwr	\$3,215.00	\$2,753.40
336320	TruckVault Inc.	T-CHCOLS1-15S-HP	Colorado Std 1 Dwr Half Width	\$2,105.00	\$1,802.77

336320	TruckVault Inc.	T-CHCOLS1-15S-PC-PL-HD	Colorado Pickup Std 1 Dwr5' Short Bed; Logo Driver's Side	\$1,995.00	\$1,708.56
336320	TruckVault Inc.	T-CHCOLS1-15S-PC-PL-HP	Colorado Pickup Std 1 Dwr	\$1,995.00	\$1,708.56
336320	TruckVault Inc.	T-CHCOLS1-15S-PC-PL-HP-PW	Colorado Pickup Std 1 Dwr	\$2,245.00	\$1,922.67
336320	TruckVault Inc.	T-CHCOLS2-04S-PC-PW	Chevrolet Colorado Pickup Std 2 Dwr, dimensions: 58L x 41W	\$3,315.00	\$2,839.04
336320	TruckVault Inc.	T-CHCOLS2-04S-PW	Chevrolet Colorado Pickup Std 2 Dwr, dimensions: 69L x 42W	\$4,045.00	\$3,464.23
336320	TruckVault Inc.	T-CHCOLS2-15S	Colorado Pickup Std 2 Dwr	\$3,145.00	\$2,693.45
336320	TruckVault Inc.	T-CHCOLS2-15S-HT	Colorado Pickup Std 2 Dwr	\$3,840.00	\$3,288.66
336320	TruckVault Inc.	T-CHCOLS2-15S-PC-PL	Colorado Pickup Std 2 Dwr	\$2,945.00	\$2,522.17
336320	TruckVault Inc.	T-CHCOLS2-15S-PC-PL-PW	Colorado Pickup Std 2 Dwr	\$3,745.00	\$3,207.30
336320	TruckVault Inc.	T-CHCOLS2-15S-PC-PW	Chevrolet Colorado Pickup Std 2 Dwr, dimensions: 59.5L x 43W	\$3,745.00	\$3,207.30
336320	TruckVault Inc.	T-CHCOLS2-15S-PL	Colorado Pickup Std 2 Dwr	\$3,145.00	\$2,693.45
336320	TruckVault Inc.	T-CHCOLS2-15S-PL-PW	Chevrolet Colorado Pickup Std 2 Dwr, dimensions: 71L x 43W	\$4,045.00	\$3,464.23
336320	TruckVault Inc.	T-CHCOLS2-15S-PW	Chevrolet Colorado Pickup Std 2 Dwr, dimensions: 72L x 43W	\$4,045.00	\$3,464.23
336320	TruckVault Inc.	T-CHCOLSO-04S-BS	Colorado Pickup Std Offset	\$2,845.00	\$2,436.52
336320	TruckVault Inc.	T-CHCOLSO-04S-PC-BS	Chevrolet Colorado Pickup Std Offset, dimensions: 56.5L x 44W	\$2,645.00	\$2,265.24
336320	TruckVault Inc.	T-CHCOLSO-04S-PW	Chevrolet Colorado Pickup Std Offset, dimensions: 69L x 42W	\$4,045.00	\$3,464.23
336320	TruckVault Inc.	T-CHCOLSO-15S-PC	Colorado Pickup Std Offset Dwr	\$2,945.00	\$2,522.17
336320	TruckVault Inc.	T-CHCOLSO-15S-PC-PL	Colorado Pickup Std O/S Dwr	\$2,945.00	\$2,522.17
336320	TruckVault Inc.	T-CHCOLSO-15S-PC-PL-PW	Colorado Pickup Std Offset Dwr	\$3,745.00	\$3,207.30
336320	TruckVault Inc.	T-CHCOLSO-15S-PC-PW	Chevrolet Colorado Pickup Std Offset Dwr, dimensions: 59.5L x 43W	\$3,745.00	\$3,207.30
336320	TruckVault Inc.	T-CHCOLSO-15S-PL	Colorado Pickup Std Offset Dwr	\$3,145.00	\$2,693.45
336320	TruckVault Inc.	T-CHCOLSO-15S-PW	Colorado Pickup Std OS Dwr	\$4,045.00	\$3,464.23
336320	TruckVault Inc.	T-CHCOLU1-15S-HP-PW	Colorado Pickup Utility 1 Dwr	\$2,545.00	\$2,179.60
336320	TruckVault Inc.	T-CHCOLU1-15S-PC-PL-HD	Colorado Pickup Utility 1 Dwr	\$2,095.00	\$1,794.21
336320	TruckVault Inc.	T-CHCOLU2-04S-PC	Colorado Pickup Utility 2 Dwr	\$3,045.00	\$2,607.81
336320	TruckVault Inc.	T-CHCOLU2-04S-PC-PW	Colorado Pickup Utility 2 Dwr	\$3,845.00	\$3,292.95
336320	TruckVault Inc.	T-CHCOLU2-04S-PW	Colorado Pickup Utility 2 Dwr	\$4,145.00	\$3,549.87
336320	TruckVault Inc.	T-CHCOLU2-15S	Colorado Pickup Utility 2 Dwr	\$3,245.00	\$2,779.09
336320	TruckVault Inc.	T-CHCOLU2-15S-PC	Colorado Pickup Utility 2 Dwr	\$3,045.00	\$2,607.81
336320	TruckVault Inc.	T-CHCOLU2-15S-PC-PL	Colorado Pickup Utility 2 Dwr	\$3,045.00	\$2,607.81
336320	TruckVault Inc.	T-CHCOLU2-15S-PC-PL-PW	Colorado Pickup Utility 2 Dwr	\$3,845.00	\$3,292.95
336320	TruckVault Inc.	T-CHCOLU2-15S-PC-PW	Colorado Pickup Utility 2 Dwr	\$3,845.00	\$3,292.95
336320	TruckVault Inc.	T-CHCOLU2-15S-PW	Colorado Pickup Utility 2 Dwr	\$4,145.00	\$3,549.87
336320	TruckVault Inc.	T-CHCOLUO-15S	Colorado Pickup Utility 2 Dwr Offset	\$3,245.00	\$2,779.09
336320	TruckVault Inc.	T-CHCOLUO-15S-PC	Colorado Pickup Utility OS Dwr	\$3,045.00	\$2,607.81
336320	TruckVault Inc.	T-CHCOLUO-15S-PC-PL-PW	Colorado Pickup Utility Offset Dwr	\$3,845.00	\$3,292.95
336320	TruckVault Inc.	T-CHCOLUO-15S-PC-PW	Colorado Pickup Utility Offset DwrShort Bed, Crew Cab	\$3,845.00	\$3,292.95
336320	TruckVault Inc.	T-CHCOLUO-15S-PW	Colorado Pickup Utility OS Dwr	\$4,145.00	\$3,549.87
336320	TruckVault Inc.	T-CHCSEM1-73S-HD-PW	Silverado Mag 1 Dwr Half Width	\$3,045.00	\$2,607.81
336320	TruckVault Inc.	T-CHCSEM1-99L-HP	Silverado Mag 1 Dwr Half Width	\$2,655.00	\$2,273.80
336320	TruckVault Inc.	T-CHCSEM2-73S-PW	Silverado Pickup Mag 2 Dwr	\$4,645.00	\$3,978.09
336320	TruckVault Inc.	T-CHCSEM2-78L-PW	Chevrolet Silverado Pickup Mag 2 Dwr, dimensions: 96L x 48W	\$4,945.00	\$4,235.01
336320	TruckVault Inc.	T-CHCSEM2-88L	Chevrolet Silverado Pickup Mag 2 Dwr, dimensions: 94.5L x 48W	\$3,945.00	\$3,378.59
336320	TruckVault Inc.	T-CHCSEM2-88L-PW	Chevrolet Silverado Pickup Mag 2 Dwr, dimensions: 94.5L x 48W	\$4,945.00	\$4,235.01
336320	TruckVault Inc.	T-CHCSEM2-88S	Chevrolet Silverado Pickup Mag 2 Dwr, dimensions: 75.25L x 47W	\$3,745.00	\$3,207.30
336320	TruckVault Inc.	T-CHCSEM2-88S-PW	Chevrolet Silverado Pickup Mag 2 Dwr, dimensions: 78L x 48W	\$4,645.00	\$3,978.09
336320	TruckVault Inc.	T-CHCSEM2-99L	Chevrolet Silverado Pickup Mag 2 Dwr, dimensions: 65.5L x 50.25W	\$3,545.00	\$3,036.02
336320	TruckVault Inc.	T-CHCSEM2-99L-PT	Chevrolet Silverado Pickup Mag 2 Dwr, dimensions: 94L x 48W	\$4,640.00	\$3,973.80
336320	TruckVault Inc.	T-CHCSEM2-99L-PW	Chevrolet Silverado Pickup Mag 2 Dwr, dimensions: 96L x 48W	\$4,945.00	\$4,235.01
336320	TruckVault Inc.	T-CHCSEM2-99S	Chevrolet Silverado Pickup Mag 2 Dwr, dimensions: 76.25L x 49.25W	\$3,745.00	\$3,207.30
336320	TruckVault Inc.	T-CHCSEM2-99S-PT	Chevrolet Silverado Pickup Mag 2 Dwr, dimensions: 75.25L x 48W	\$4,440.00	\$3,802.52
336320	TruckVault Inc.	T-CHCSEM2-99S-PW	Chevrolet Silverado Pickup Mag 2 Dwr, dimensions: 78L x 49.25W	\$4,645.00	\$3,978.09
336320	TruckVault Inc.	T-CHCSEMO-88L	Chevrolet Silverado Pickup Mag OS Dwr, dimensions: 94.5L x 48W	\$3,945.00	\$3,378.59
336320	TruckVault Inc.	T-CHCSEMO-88S	Chevrolet Silverado Pickup Mag OS Dwr, dimensions: 75.25L x 47W	\$3,745.00	\$3,207.30
336320	TruckVault Inc.	T-CHCSEMO-88S-PW	Chevrolet Silverado Pickup Mag OS Dwr, dimensions: 78L x 48W	\$4,645.00	\$3,978.09
336320	TruckVault Inc.	T-CHCSEMO-99L	Chevrolet Silverado Pickup Mag OS Dwr, dimensions: 95.5L x 50.5W	\$3,945.00	\$3,378.59
336320	TruckVault Inc.	T-CHCSEMO-99L-PT	Chevrolet Silverado Pickup Mag OffsetDwr, dimensions: 95.5L x 50.5W	\$4,640.00	\$3,973.80
336320	TruckVault Inc.	T-CHCSEMO-99L-PW	Chevrolet Silverado Pickup Mag OS Dwr, dimensions: 96L x 48W	\$4,945.00	\$4,235.01
336320	TruckVault Inc.	T-CHCSEMO-99S	Chevrolet Silverado Pickup Mag OS Dwr, dimensions: 75.25L x 48W	\$3,745.00	\$3,207.30



336320	TruckVault Inc.	T-CHCSEMO-99S-PW	Chevrolet Silverado Pickup Mag OS Dwr, dimensions: 78L x 49.25W	\$4,645.00	\$3,978.09
336320	TruckVault Inc.	T-CHCSES1-73S-HD-PW	Silverado Std 1 Dwr Half Width	\$2,845.00	\$2,436.52
336320	TruckVault Inc.	T-CHCSES1-88L-HP-PW	Silverado Std 1 Dwr Half Width	\$3,045.00	\$2,607.81
336320	TruckVault Inc.	T-CHCSES2-73L-PW	Silverado Pickup Std 2 Dwr	\$4,745.00	\$4,063.73
336320	TruckVault Inc.	T-CHCSES2-73S-PW	Silverado Pickup Std 2 Dwr	\$4,445.00	\$3,806.80
336320	TruckVault Inc.	T-CHCSES2-78L	Chevrolet Silverado Pickup Std 2 Dwr, dimensions: 94.625L x 48W	\$3,745.00	\$3,207.30
336320	TruckVault Inc.	T-CHCSES2-88L	Chevrolet Silverado Pickup Std 2 Dwr, dimensions: 96L x 48W	\$3,745.00	\$3,207.30
336320	TruckVault Inc.	T-CHCSES2-88L-PW	Chevrolet Silverado Pickup Std 2 Dwr, dimensions: 94.5L x 48W	\$4,745.00	\$4,063.73
336320	TruckVault Inc.	T-CHCSES2-88S	Chevrolet Silverado Pickup Std 2 Dwr, dimensions: 75.75L x 48W	\$3,545.00	\$3,036.02
336320	TruckVault Inc.	T-CHCSES2-88S-PW	Chevrolet Silverado Pickup Std 2 Dwr, dimensions: 75.75L x 48W	\$3,755.00	\$3,215.87
336320	TruckVault Inc.	T-CHCSES2-99L	Chevrolet Silverado Pickup Std 2 Dwr, dimensions: 94.25L x 48W	\$3,745.00	\$3,207.30
336320	TruckVault Inc.	T-CHCSES2-99L-PW	Chevrolet Silverado Pickup Std 2 Dwr, dimensions: 96L x 48W	\$4,745.00	\$4,063.73
336320	TruckVault Inc.	T-CHCSES2-99S	Chevrolet Silverado Pickup Std 2 Dwr, dimensions: 76.25L x 49.25W	\$3,545.00	\$3,036.02
336320	TruckVault Inc.	T-CHCSES2-99S-PT	Chevrolet Silverado Pickup Std 2 Dwr, dimensions: 75.25L x 48W	\$4,240.00	\$3,631.23
336320	TruckVault Inc.	T-CHCSES2-99S-PW	Chevrolet Silverado Pickup Std 2 Dwr, dimensions: 78L x 49.25W	\$4,445.00	\$3,806.80
336320	TruckVault Inc.	T-CHCSES2-99S-Z2	Silverado Pickup CUST Std 2	\$0.01	\$0.01
336320	TruckVault Inc.	T-CHCSES2-99S-ZC10814	Silverado Pickup Custom 2 Dwr6' 6" Bed, AI's Modifications	\$5,245.00	\$4,491.94
336320	TruckVault Inc.	T-CHCSES0-78L	Chevrolet Silverado Pickup Std OS Dwr, dimensions: 94.625L x 48W	\$3,745.00	\$3,207.30
336320	TruckVault Inc.	T-CHCSES0-88L-PW	Chevrolet Silverado Pickup Std OS Dwr, dimensions: 94.5L x 48W	\$4,745.00	\$4,063.73
336320	TruckVault Inc.	T-CHCSES0-88S	Chevrolet Silverado Pickup Std OS Dwr, dimensions: 75.75L x 48W	\$3,545.00	\$3,036.02
336320	TruckVault Inc.	T-CHCSES0-99L	Chevrolet Silverado Pickup Std OS Dwr, dimensions: 94L x 48W	\$3,745.00	\$3,207.30
336320	TruckVault Inc.	T-CHCSES0-99L-PW	Chevrolet Silverado Pickup Std OS Dwr, dimensions: 96L x 48W	\$4,745.00	\$4,063.73
336320	TruckVault Inc.	T-CHCSES0-99S	Chevrolet Silverado Pickup Std OS Dwr, dimensions: 75.25L x 48W	\$3,545.00	\$3,036.02
336320	TruckVault Inc.	T-CHCSES0-99S-PT	Chevrolet Silverado Pickup Std OffsetDwr, dimensions: 74.25L x 48W	\$4,240.00	\$3,631.23
336320	TruckVault Inc.	T-CHCSES0-99S-PW	Chevrolet Silverado Pickup Std OS Dwr, dimensions: 78L x 49.25W	\$4,445.00	\$3,806.80
336320	TruckVault Inc.	T-CHCSEU1-99L-HP	Silverado Utility 1 Dwr Half Width	\$2,545.00	\$2,179.60
336320	TruckVault Inc.	T-CHCSEU2-99L	Silverado Pickup Utility 2 Dwr	\$3,845.00	\$3,292.95
336320	TruckVault Inc.	T-CHCSEU2-99L-PW	Silverado Pickup Utility 2 Dwr	\$4,845.00	\$4,149.37
336320	TruckVault Inc.	T-CHCSEU2-99S-PW	Silverado Pickup Utility 2 Dwr6' 6" Bed, A-Wthr	\$4,545.00	\$3,892.44
336320	TruckVault Inc.	T-CHCSEUO-99S-PW	Silverado Pickup Utility 2 Dwr Offset6' 6" Bed, A-Wthr	\$4,545.00	\$3,892.44
336320	TruckVault Inc.	T-CHCSSM2-95S	Chevrolet Sportside Pickup Mag 2 Dwr, dimensions: 76L x 48W	\$3,425.00	\$2,933.25
336320	TruckVault Inc.	T-CHCSSM2-95S-PW	Chevrolet Sportside Pickup Mag 2 Dwr, dimensions: 78L x 48W	\$4,415.00	\$3,781.11
336320	TruckVault Inc.	T-CHCSSS2-95S	Chevrolet Sportside Pickup Std 2 Dwr, dimensions: 76L x 48W	\$3,205.00	\$2,744.84
336320	TruckVault Inc.	T-CHCSSS2-95S-PW	Chevrolet Sportside Pickup Std 2 Dwr, dimensions: 78L x 48W	\$4,195.00	\$3,592.70
336320	TruckVault Inc.	T-CHEQXM1-05N	Chevrolet Equinox Mag 1 Dwr, dimensions: 28L x 34.75W	\$1,895.00	\$1,622.92
336320	TruckVault Inc.	T-CHEQXM1-10N	Chevrolet Equinox Mag 1 Dwr, dimensions: 28L x 37W	\$2,095.00	\$1,794.21
336320	TruckVault Inc.	T-CHEQXM1-10N-HG	Equinox Mag 1 Dwr	\$2,185.00	\$1,871.28
336320	TruckVault Inc.	T-CHEQXM1-10N-HT	Chevrolet Equinox Mag 1 Dwr, dimensions: 28L x 37W	\$2,990.00	\$2,560.71
336320	TruckVault Inc.	T-CHEQXM1-10N-PP	Chevrolet Equinox Mag 1 Dwr, dimensions: 25L x 37W	\$2,095.00	\$1,794.21
336320	TruckVault Inc.	T-CHEQXM1-18N	Equinox Mag 1 Dwr	\$2,025.00	\$1,734.26
336320	TruckVault Inc.	T-CHEQXM1-18N-HG	Equinox Mag 1 Dwr	\$2,045.00	\$1,751.39
336320	TruckVault Inc.	T-CHEQXM2-10N	Chevrolet Equinox Mag 2 Dwr, dimensions: 28L x 37W	\$2,645.00	\$2,265.24
336320	TruckVault Inc.	T-CHEQXM2-18N	Equinox Mag 2 Dwr	\$2,645.00	\$2,265.24
336320	TruckVault Inc.	T-CHEQXM2-18N-HG	Equinox Mag 2 DwrElevated Vault	\$2,445.00	\$2,093.95
336320	TruckVault Inc.	T-CHEQXMO-05N	Chevrolet Equinox Mag OS Dwr, dimensions: 28L x 34.75W	\$2,445.00	\$2,093.95
336320	TruckVault Inc.	T-CHEQXMO-10N	Chevrolet Equinox Mag Offset Dwr, dimensions: 28L x 37W	\$2,645.00	\$2,265.24
336320	TruckVault Inc.	T-CHEQXN1-10N-HG	Equinox 1 Dwr Hanging Design	\$2,045.00	\$1,751.39
336320	TruckVault Inc.	T-CHEQXS1-05N	Chevrolet Equinox Std 1 Dwr, dimensions: 31L x 34.75W	\$1,695.00	\$1,451.64
336320	TruckVault Inc.	T-CHEQXS1-10N	Chevrolet Equinox Std 1 Dwr, dimensions: 30L x 37W	\$1,895.00	\$1,622.92
336320	TruckVault Inc.	T-CHEQXS1-10N-HG	Equinox 1 Dwr Hanging DesignC4852	\$2,045.00	\$1,751.39
336320	TruckVault Inc.	T-CHEQXS1-10N-HT	Equinox Std 1 Dwr	\$2,590.00	\$2,218.14
336320	TruckVault Inc.	T-CHEQXS1-10N-PT	Chevrolet Equinox Std 1 Dwr, dimensions: 30L x 37W	\$2,590.00	\$2,218.14
336320	TruckVault Inc.	T-CHEQXS1-18N	Equinox Std 1 Dwr	\$1,895.00	\$1,622.92
336320	TruckVault Inc.	T-CHEQXS1-18N-HG	Equinox Std 1 DwrElevated Vault	\$1,845.00	\$1,580.10
336320	TruckVault Inc.	T-CHEQXS2-05N	Chevrolet Equinox Std 2 Dwr, dimensions: 31L x 34.75W	\$2,245.00	\$1,922.67
336320	TruckVault Inc.	T-CHEQXS2-10N	Chevrolet Equinox Std 2 Dwr, dimensions: 30L x 37W	\$2,445.00	\$2,093.95
336320	TruckVault Inc.	T-CHEQXS2-10N-HT	Equinox Std 2 Dwr	\$3,140.00	\$2,689.17
336320	TruckVault Inc.	T-CHEQXS2-18N	Equinox Std 2 Dwr	\$2,445.00	\$2,093.95
336320	TruckVault Inc.	T-CHEQXSO-05N	Chevrolet Equinox Std OS Dwr, dimensions: 31L x 37W	\$2,445.00	\$2,093.95
336320	TruckVault Inc.	T-CHEQXSO-10N	Chevrolet Equinox Std Offset Dwr, dimensions: 30L x 37W	\$2,445.00	\$2,093.95
336320	TruckVault Inc.	T-CHEQXSO-18N	Equinox Std Offset Dwr	\$2,445.00	\$2,093.95

336320	TruckVault Inc.	T-CHEXQUO-05N-HT	Equinox Utility Offset Dwr	\$3,120.00	\$2,672.04
336320	TruckVault Inc.	T-CHEXPM1-16S	Express Van Mag 1 Dwr	\$2,295.00	\$1,965.49
336320	TruckVault Inc.	T-CHEXPM2-98L	Chevrolet Full Size Van Mag 2 Dwr, dimensions: 62L x 48W	\$3,245.00	\$2,779.09
336320	TruckVault Inc.	T-CHEXPM2-98L-PT	Chevrolet Full Size Van Mag 2 Dwr, dimensions: 60L x 48W	\$3,940.00	\$3,374.31
336320	TruckVault Inc.	T-CHEXPMO-98L-PT	Chevrolet Full Size Van Mag OS Dwr, dimensions: 60L x 48W	\$3,940.00	\$3,374.31
336320	TruckVault Inc.	T-CHEXPN1-16N-HG-ZC8503	Express Van Cust 1 Dwr	\$2,455.00	\$2,102.52
336320	TruckVault Inc.	T-CHEXPS2-98L	Chevrolet Full Size Van Std 2 Dwr, dimensions: 62L x 48W	\$2,985.00	\$2,556.42
336320	TruckVault Inc.	T-CHEXPSO-98L	Chevrolet Full Size Van Std Offset, dimensions: 62L x 48W	\$2,985.00	\$2,556.42
336320	TruckVault Inc.	T-CHHHRM1-06N	Chevrolet HHR Mag 1 Dwr, dimensions: 26L x 38.75W	\$2,095.00	\$1,794.21
336320	TruckVault Inc.	T-CHHHRM2-06N	Chevrolet HHR Mag 2 Dwr, dimensions: 26L x 38.75W	\$2,645.00	\$2,265.24
336320	TruckVault Inc.	T-CHHHRM1-06N	Chevrolet HHR Std 1 Dwr, dimensions: 28L x 38.75W	\$1,895.00	\$1,622.92
336320	TruckVault Inc.	T-CHHHRM2-06N	Chevrolet HHR Std 2 Dwr, dimensions: 28L x 38.75W	\$2,445.00	\$2,093.95
336320	TruckVault Inc.	T-CHSBLM1-01N-D2	Chevrolet S-10 Blazer Mag 1 Dwr, dimensions: 27.5L x 37.5W	\$2,215.00	\$1,896.98
336320	TruckVault Inc.	T-CHSBLM1-95N	Chevrolet S-10 Blazer Mag 1 Dwr, dimensions: 33L x 38W	\$2,095.00	\$1,794.21
336320	TruckVault Inc.	T-CHSBLM2-01N-D2	Chevrolet S-10 Blazer Mag 2 Dwr, dimensions: 27.5L x 37.5W	\$2,755.00	\$2,359.45
336320	TruckVault Inc.	T-CHSBLM2-95N	Chevrolet S-10 Blazer Mag 2 Dwr, dimensions: 33L x 38W	\$2,645.00	\$2,265.24
336320	TruckVault Inc.	T-CHSBLM2-95N-D2	Chevrolet S-10 Blazer Mag 2 Dwr, dimensions: 28L x 38W	\$2,795.00	\$2,393.70
336320	TruckVault Inc.	T-CHSBLMO-95N	Chevrolet S-10 Blazer Mag OS Dwr, dimensions: 33L x 38W	\$2,645.00	\$2,265.24
336320	TruckVault Inc.	T-CHSBSL1-01N-D2	Chevrolet S-10 Blazer Std 1 Dwr, dimensions: 29L x 37W	\$1,995.00	\$1,708.56
336320	TruckVault Inc.	T-CHSBSL1-95N	Chevrolet S-10 Blazer Std 1 Dwr, dimensions: 35L x 38W	\$1,895.00	\$1,622.92
336320	TruckVault Inc.	T-CHSBSL1-95N-D2	Chevrolet S-10 Blazer Std 1 Dwr, dimensions: 29L x 38W	\$2,215.00	\$1,896.98
336320	TruckVault Inc.	T-CHSBSL2-01N-D2	Chevrolet S-10 Blazer Std 2 Dwr, dimensions: 29L x 37.5W	\$2,515.00	\$2,153.90
336320	TruckVault Inc.	T-CHSBSL2-95N	Chevrolet S-10 Blazer Std 2 Dwr, dimensions: 35L x 38W	\$2,445.00	\$2,093.95
336320	TruckVault Inc.	T-CHSBSL2-95N-D2	Chevrolet S-10 Blazer Std 2 Dwr, dimensions: 29L x 38W	\$2,755.00	\$2,359.45
336320	TruckVault Inc.	T-CHSBSLSL-95N	Chevrolet S-10 Blazer Std L Dwr, dimensions: 43L x 35W	\$2,025.00	\$1,734.26
336320	TruckVault Inc.	T-CHSBSLSO-01N-D2	Chevrolet S-10 Blazer Std OS Dwr, dimensions: 29L x 37.5W	\$2,755.00	\$2,359.45
336320	TruckVault Inc.	T-CHSILM1-04S-PC-HP-PW	Silverado Mag 1 Dwr Half Width	\$2,745.00	\$2,350.88
336320	TruckVault Inc.	T-CHSILM1-07L-HD	Chevrolet Silverado Mag 1 Dwr Half Width, dimensions: 95L x 24W	\$2,655.00	\$2,273.80
336320	TruckVault Inc.	T-CHSILM1-07L-HD-PW	Chevrolet Silverado Mag 1 Dwr Half Width, dimensions: 96L x 24W	\$3,245.00	\$2,779.09
336320	TruckVault Inc.	T-CHSILM1-07L-HP	Chevrolet Silverado Mag 1 Dwr Half Width, dimensions: 94L x 24W	\$2,655.00	\$2,273.80
336320	TruckVault Inc.	T-CHSILM1-07L-HP-PW	Chevrolet Silverado Mag 1 Dwr Half Width, dimensions: 96L x 24W	\$3,245.00	\$2,779.09
336320	TruckVault Inc.	T-CHSILM1-07S-HD	Chevrolet Silverado Mag 1 Dwr Half Width, dimensions: 74L x 24W	\$2,545.00	\$2,179.60
336320	TruckVault Inc.	T-CHSILM1-07S-HD-PW	Silverado Mag 1 Dwr Half Width	\$3,045.00	\$2,607.81
336320	TruckVault Inc.	T-CHSILM1-07S-HD-ZC9069	Silverado Mag 1 Dwr Half Width	\$2,255.00	\$1,931.23
336320	TruckVault Inc.	T-CHSILM1-07S-HP	Chevrolet Silverado Mag 1 Dwr Half Width, dimensions: 76L x 48W	\$2,545.00	\$2,179.60
336320	TruckVault Inc.	T-CHSILM1-07S-HP-PW	Chevrolet Silverado Mag 1 Dwr Half Width, dimensions: 75L x 25.25W	\$3,045.00	\$2,607.81
336320	TruckVault Inc.	T-CHSILM1-07S-PC-HD-PW	Chevrolet Silverado Mag 1 Dwr Half Width, dimensions: 66L x 24.625W	\$2,745.00	\$2,350.88
336320	TruckVault Inc.	T-CHSILM1-07S-PC-HP-PW	Chevrolet Silverado Mag 1 Dwr Half Width, dimensions: 66L x 24.625W	\$2,745.00	\$2,350.88
336320	TruckVault Inc.	T-CHSILM1-07S-PC-HP-ZC9367	Silverado Mag 1 Dwr Half Width	\$2,255.00	\$1,931.23
336320	TruckVault Inc.	T-CHSILM1-07S-PC-HP-ZC9445	Silverado Mag 1 Dwr	\$2,255.00	\$1,931.23
336320	TruckVault Inc.	T-CHSILM1-07S-PC-ZC4910	Silverado Custom Mag 1 DwrC4910	\$3,025.00	\$2,590.68
336320	TruckVault Inc.	T-CHSILM1-15S-PC-HD-RX-PW	Silverado Mag 1 Dwr Half Width5' 6", All Wthr; Drivers Side ReTrax	\$2,375.00	\$2,034.01
336320	TruckVault Inc.	T-CHSILM1-19S-HD	Silverado Mag 1 Dwr Half Width6' 6" Bed, DriversSide	\$2,545.00	\$2,179.60
336320	TruckVault Inc.	T-CHSILM1-19S-HD-PW	Silverado Mag 1 Dwr Half Width	\$3,045.00	\$2,607.81
336320	TruckVault Inc.	T-CHSILM1-19S-HP	Silverado Mag 1 Dwr Half Width	\$2,545.00	\$2,179.60
336320	TruckVault Inc.	T-CHSILM1-19S-HP-PW	Silverado Mag 1 Dwr Half Width	\$3,045.00	\$2,607.81
336320	TruckVault Inc.	T-CHSILM1-19S-PC-HD	Silverado Mag 1 Dwr Half Width5' 8" Bed, Drivers Side	\$2,435.00	\$2,085.39
336320	TruckVault Inc.	T-CHSILM1-19S-PC-HD-PW	Silverado Mag 1 Dwr Half Width	\$2,745.00	\$2,350.88
336320	TruckVault Inc.	T-CHSILM1-19S-PC-HN-ZC11690	Silverado Pickup Custom	\$1,895.00	\$1,622.92
336320	TruckVault Inc.	T-CHSILM1-19S-PC-HP	Silverado Mag 1 Dwr Half Width	\$2,435.00	\$2,085.39
336320	TruckVault Inc.	T-CHSILM1-19S-PC-HP-PW	Silverado Mag 1 Dwr Half Width	\$2,745.00	\$2,350.88
336320	TruckVault Inc.	T-CHSILM1-19S-PC-HP-PW-ZC10777	Silverado Mag 1 Dwr Half Width6' 6", All Wthr; Passenger Side	\$3,635.00	\$3,113.10
336320	TruckVault Inc.	T-CHSILM1-19S-PC-HP-PW-ZC9724	Silverado Pickup Mag 1 Dwr	\$2,585.00	\$2,213.85
336320	TruckVault Inc.	T-CHSILM1-19S-PC-HP-ZC9322	Silverado Mag 1 Dwr Half Width	\$2,255.00	\$1,931.23
336320	TruckVault Inc.	T-CHSILM1-19S-PC-HP-ZC9447	Silverado Mag 1 Dwr	\$2,255.00	\$1,931.23
336320	TruckVault Inc.	T-CHSILM1-19S-PC-ZC4910	Silverado Custom Mag 1 DwrC10642	\$3,295.00	\$2,821.91
336320	TruckVault Inc.	T-CHSILM1-20S-P5-HD-PW	Silverado Mag 1 Dwr Half Width6'6", All Wthr; Drivers Side	\$3,045.00	\$2,607.81
336320	TruckVault Inc.	T-CHSILM1-20S-P5-HD-PW-ZC9962	Silverado 2500/3500 Mag 1 Dwr Half Width6' 8" Bed; All Weather; Drivers Side	\$2,715.00	\$2,325.19

336320	TruckVault Inc.	T-CHSILM1-20S-P5-HP-ZC10159	Silverado 2500/3500 Mag 1 Dwr Half Width6' 8" Bed, Passenger Side, C10159	\$2,435.00	\$2,085.39
336320	TruckVault Inc.	T-CHSILM2-04S-PC	Chevrolet Silverado Pickup Mag 2 Dwr, dimensions: 65.5L x 53W	\$3,545.00	\$3,036.02
336320	TruckVault Inc.	T-CHSILM2-04S-PC-PW	Chevrolet Silverado Pickup Mag 2 Dwr, dimensions: 68L x 53W	\$4,345.00	\$3,721.16
336320	TruckVault Inc.	T-CHSILM2-07L	Chevrolet Silverado Pickup Mag 2 Dwr, dimensions: 96L x 50.5W	\$3,945.00	\$3,378.59
336320	TruckVault Inc.	T-CHSILM2-07L-PW	Chevrolet Silverado Pickup Mag 2 Dwr, dimensions: 94L x 48W	\$4,945.00	\$4,235.01
336320	TruckVault Inc.	T-CHSILM2-07S	Chevrolet Silverado Pickup Mag 2 Dwr, dimensions: 76L x 48W	\$3,745.00	\$3,207.30
336320	TruckVault Inc.	T-CHSILM2-07S-HT	Silverado Pickup Mag 2 Dwr	\$4,440.00	\$3,802.52
336320	TruckVault Inc.	T-CHSILM2-07S-HT-PW	Silverado Pickup Mag 2 Dwr	\$5,340.00	\$4,573.30
336320	TruckVault Inc.	T-CHSILM2-07S-PC	Chevrolet Silverado Pickup Mag 2 Dwr, dimensions: 66L x 53W	\$3,545.00	\$3,036.02
336320	TruckVault Inc.	T-CHSILM2-07S-PC-PT	Silverado Pickup Mag 2 Dwr	\$4,240.00	\$3,631.23
336320	TruckVault Inc.	T-CHSILM2-07S-PC-PW	Chevrolet Silverado Pickup Mag 2 Dwr, dimensions: 66L x 48W	\$4,345.00	\$3,721.16
336320	TruckVault Inc.	T-CHSILM2-07S-PC-PW-ZC8484	Silverado Pickup Mag 2 Dwr	\$4,525.00	\$3,875.31
336320	TruckVault Inc.	T-CHSILM2-07S-PC-ZC10067	Silverado Pickup Custom 2 Dwr	\$3,235.00	\$2,770.53
336320	TruckVault Inc.	T-CHSILM2-07S-PT	Chevrolet Silverado Pickup Mag 2 Dwr, dimensions: 75L x 48W	\$4,440.00	\$3,802.52
336320	TruckVault Inc.	T-CHSILM2-07S-PW	Chevrolet Silverado Pickup Mag 2 Dwr, dimensions: 75L x 48W	\$4,645.00	\$3,978.09
336320	TruckVault Inc.	T-CHSILM2-07S-PW-ZC7866	Silverado Pickup Custom 2 Dwr	\$3,725.00	\$3,190.18
336320	TruckVault Inc.	T-CHSILM2-15S-PC-ZC9304	Silverado Pickup Mag 2 Dwr	\$2,965.00	\$2,539.29
336320	TruckVault Inc.	T-CHSILM2-19L	Silverado Pickup Mag 2 Dwr	\$3,945.00	\$3,378.59
336320	TruckVault Inc.	T-CHSILM2-19S	Silverado Pickup Magnum 2 Dwr	\$3,745.00	\$3,207.30
336320	TruckVault Inc.	T-CHSILM2-19S-HT-PW	Silverado Pickup Mag 2 Dwr6' 6" Short Bed, AW Heavy Duty Table	\$5,340.00	\$4,573.30
336320	TruckVault Inc.	T-CHSILM2-19S-PC	Silverado Pickup Mag 2 Dwr	\$3,545.00	\$3,036.02
336320	TruckVault Inc.	T-CHSILM2-19S-PC-HT-PW	Silverado Pickup Mag 2 Dwr5' 8" Bed, Crew Cab, AW; Heavy Duty Table	\$5,040.00	\$4,316.37
336320	TruckVault Inc.	T-CHSILM2-19S-PC-PW	Silverado Pickup Mag 2 Dwr	\$4,345.00	\$3,721.16
336320	TruckVault Inc.	T-CHSILM2-19S-PC-RX	Silverado Pickup Mag 2 Dwr5' 8" Bed, Crew Cab ReMax	\$3,345.00	\$2,864.74
336320	TruckVault Inc.	T-CHSILM2-19S-PW	Silverado Pickup Mag 2 Dwr	\$4,645.00	\$3,978.09
336320	TruckVault Inc.	T-CHSILM2-20L-P5	Silverado Pickup Mag 2 Dwr8' Long Bed 2500	\$3,945.00	\$3,378.59
336320	TruckVault Inc.	T-CHSILM2-20L-P5-PW	Silverado Pickup Mag 2 Dwr8' Long Bed (New), All Wthr	\$4,945.00	\$4,235.01
336320	TruckVault Inc.	T-CHSILM2-20S-P5	Silverado Pickup Magnum 2 Dwr6' 8" Short Bed	\$3,745.00	\$3,207.30
336320	TruckVault Inc.	T-CHSILM2-20S-P5-PW	Silverado 2500/3500 Mag 2 Dwr6' 8" Short Bed, A-Wthr (New)	\$4,645.00	\$3,978.09
336320	TruckVault Inc.	T-CHSILM2-20S-P5-PW-ZC10332	Silverado 2500/3500 CustomAll Weather; C10332	\$4,425.00	\$3,789.67
336320	TruckVault Inc.	T-CHSILM3-07S-P5-PW-ZC11331	Silverado 2500/3500 Pickup Mag GooseneckShortbed, A-Wthr C11331	\$5,145.00	\$4,406.30
336320	TruckVault Inc.	T-CHSILM3-20S-P5-PW-ZC10710	Silverado 2500/3500 Pickup Mag GooseneckShortbed, A-Wthr C10710	\$5,145.00	\$4,406.30
336320	TruckVault Inc.	T-CHSILM3-99L-C2-PW-ZC11668	Silverado HD Pickup Std Gooseneck	\$5,445.00	\$4,663.22
336320	TruckVault Inc.	T-CHSILMO-04S-PC	Chevrolet Silverado Pickup Mag OS Dwr, dimensions: 54.5L x 53W	\$3,345.00	\$2,864.74
336320	TruckVault Inc.	T-CHSILMO-04S-PC-PW	Chevrolet Silverado Pickup Mag OS Dwr, dimensions: 68L x 53W	\$4,345.00	\$3,721.16
336320	TruckVault Inc.	T-CHSILMO-07L	Chevrolet Silverado P/U Mag Offset Dwr, dimensions: 96L x 50.5W	\$3,945.00	\$3,378.59
336320	TruckVault Inc.	T-CHSILMO-07L-PT	Chevrolet Silverado Pickup Mag OffsetDwr, dimensions: 96L x 48W	\$4,640.00	\$3,973.80
336320	TruckVault Inc.	T-CHSILMO-07L-PW	Chevrolet Silverado Pickup Mag OS Dwr, dimensions: 94L x 48W	\$4,945.00	\$4,235.01
336320	TruckVault Inc.	T-CHSILMO-07S	Chevrolet Silverado Pickup Mag 2 Dwr OS, dimensions: 75L x 48W	\$3,745.00	\$3,207.30
336320	TruckVault Inc.	T-CHSILMO-07S-PC	Chevrolet Silverado Pickup Mag OS Dwr, dimensions: 66L x 53W	\$3,545.00	\$3,036.02
336320	TruckVault Inc.	T-CHSILMO-07S-PC-PT	Chevrolet Silverado Pickup Mag OS Dwr, dimensions: 66L x 53W	\$4,240.00	\$3,631.23
336320	TruckVault Inc.	T-CHSILMO-07S-PC-PW	Chevrolet Silverado Pickup Mag OS Dwr, dimensions: 66L x 53W	\$4,345.00	\$3,721.16
336320	TruckVault Inc.	T-CHSILMO-07S-PT	Chevrolet Silverado Pickup Mag OS Dwr, dimensions: 65.5L x 53W	\$4,240.00	\$3,631.23
336320	TruckVault Inc.	T-CHSILMO-07S-PW	Chevrolet Silverado Pickup Mag 2 Dwr OS, dimensions: 75L x 48W	\$4,645.00	\$3,978.09
336320	TruckVault Inc.	T-CHSILMO-07S-PW-HT	Silverado Pickup Mag 2 Dwr OS	\$5,340.00	\$4,573.30
336320	TruckVault Inc.	T-CHSILMO-07S-RX	Silverado Pickup Mag 2 Dwr OS6' 6" Short Bed (New) Retrax	\$3,545.00	\$3,036.02
336320	TruckVault Inc.	T-CHSILMO-07S-ZC7928	Silverado Pickup Mag 2 Dwr OS	\$2,585.00	\$2,213.85
336320	TruckVault Inc.	T-CHSILMO-19S	Silverado Pickup Mag OS Dwr	\$3,745.00	\$3,207.30
336320	TruckVault Inc.	T-CHSILMO-19S-PC	Silverado Pickup Mag OS Dwr	\$3,545.00	\$3,036.02
336320	TruckVault Inc.	T-CHSILMO-19S-PC-PW	Silverado Pickup Mag OS Dwr	\$4,345.00	\$3,721.16
336320	TruckVault Inc.	T-CHSILMO-19S-PW	Silverado Pickup Mag Offset Dwr	\$4,645.00	\$3,978.09
336320	TruckVault Inc.	T-CHSILMO-20L-P5	Silverado Pickup Mag 2 Dwr Offset	\$3,945.00	\$3,378.59
336320	TruckVault Inc.	T-CHSILMO-20L-P5-PW	Silverado Pickup Mag 2 Dwr Offset	\$4,945.00	\$4,235.01
336320	TruckVault Inc.	T-CHSILMO-20S-P5	Silverado Pickup Mag OS Dwr6' 8" Short Bed	\$3,745.00	\$3,207.30
336320	TruckVault Inc.	T-CHSILMO-20S-P5-PW	Silverado 2500/3500 Mag Offset Dwr6' 8" Short Bed, A-Wthr	\$4,645.00	\$3,978.09
336320	TruckVault Inc.	T-CHSILN0-07S-C2-PW-ZC8168	Silverado Pickup Cust Cubbies	\$2,715.00	\$2,325.19

336320	TruckVault Inc.	T-CHSILN0-19S-PC-C2-ZC10990	Silverado CustomC10990	\$1,435.00	\$1,228.97
336320	TruckVault Inc.	T-CHSILN0-19S-PC-C2-ZC11123	Silverado CustomC11123	\$1,435.00	\$1,228.97
336320	TruckVault Inc.	T-CHSILN1-07S-PC-ZC10334	Silverado CustomC10334	\$2,265.00	\$1,939.80
336320	TruckVault Inc.	T-CHSILN1-19S-PC-HP-PW-ZC10777	Silverado Custom 1 Dwr Half WidthC10777	\$3,635.00	\$3,113.10
336320	TruckVault Inc.	T-CHSILN2-07S-PC-PW-ZC8262	Silverado Pickup CUST 2 Dwr	\$4,525.00	\$3,875.31
336320	TruckVault Inc.	T-CHSILN2-07S-PW-ZC8636	Silverado Pickup CUST 2 Dwr	\$4,975.00	\$4,260.71
336320	TruckVault Inc.	T-CHSILN2-07S-PW-ZC8825	Silverado Custom	\$4,855.00	\$4,157.93
336320	TruckVault Inc.	T-CHSILN2-07S-ZC7519	Silverado Pickup CUST 2 Dwr	\$3,275.00	\$2,804.79
336320	TruckVault Inc.	T-CHSILN2-07S-ZC8802	Silverado Pickup CUST 2 Dwr	\$3,615.00	\$3,095.97
336320	TruckVault Inc.	T-CHSILN2-19L-ZC9745	Silverado Pickup Custom 2 Dwr	\$4,025.00	\$3,447.10
336320	TruckVault Inc.	T-CHSILN2-19S-HT-ZC10878	Silverado Pickup CustomC10878	\$4,395.00	\$3,763.98
336320	TruckVault Inc.	T-CHSILN2-19S-PC-HD-ZC9788	Silverado Custom 2 Dwr Stacked Half Width5' 8" Bed, Drivers Side	\$3,475.00	\$2,976.07
336320	TruckVault Inc.	T-CHSILN2-19S-ZC10291	Silverado Pickup Custom 2 DwrC10291	\$3,795.00	\$3,250.13
336320	TruckVault Inc.	T-CHSILN2-19S-ZC9744	Silverado Pickup Custom 2 Dwr	\$3,815.00	\$3,267.25
336320	TruckVault Inc.	T-CHSILN2-20L-P5-C3-PW-ZC11635	Silverado HD PU CUST Custom 2 Dwr	\$4,545.00	\$3,892.44
336320	TruckVault Inc.	T-CHSILN2-20S-P5-ZC9744	Silverado Pickup Custom 2 DwrC9744	\$3,815.00	\$3,267.25
336320	TruckVault Inc.	T-CHSILN0-07S-PW-ZC10671A	Silverado Pickup Custom Height 2 Dwr offset6' 6" Short Bed, A-Wthr (New)	\$4,845.00	\$4,149.37
336320	TruckVault Inc.	T-CHSILS1-07L-HD	Chevrolet Silverado Std 1 Dwr Half Width, dimensions: 95L x 24W	\$2,435.00	\$2,085.39
336320	TruckVault Inc.	T-CHSILS1-07L-HD-PW	Chevrolet Silverado Std 1 Dwr Half Width, dimensions: 96L x 49.25W	\$3,045.00	\$2,607.81
336320	TruckVault Inc.	T-CHSILS1-07L-HP	Chevrolet Silverado Std 1 Dwr Half Width, dimensions: 96L x 24W	\$2,435.00	\$2,085.39
336320	TruckVault Inc.	T-CHSILS1-07L-HP-PW	Chevrolet Silverado Std 1 Dwr Half Width, dimensions: 96L x 24.625W	\$3,045.00	\$2,607.81
336320	TruckVault Inc.	T-CHSILS1-07S-HD	Chevrolet Silverado Std 1 Dwr Half Width, dimensions: 76L x 24W	\$2,325.00	\$1,991.18
336320	TruckVault Inc.	T-CHSILS1-07S-HD-PW	Chevrolet Silverado Std 1 Dwr Half Width, dimensions: 77L x 25.25W	\$2,845.00	\$2,436.52
336320	TruckVault Inc.	T-CHSILS1-07S-HP	Chevrolet Silverado Std 1 Dwr Half Width, dimensions: 76L x 25.25W	\$2,325.00	\$1,991.18
336320	TruckVault Inc.	T-CHSILS1-07S-HP-PW	Chevrolet Silverado Std 1 Dwr Half Width, dimensions: 96L x 49.25W	\$3,045.00	\$2,607.81
336320	TruckVault Inc.	T-CHSILS1-07S-PC-HD-PW	Chevrolet Silverado Std 1 Dwr Half Width, dimensions: 66L x 53W	\$2,545.00	\$2,179.60
336320	TruckVault Inc.	T-CHSILS1-07S-PC-HP-PW	Chevrolet Silverado Std 1 Dwr Half Width, dimensions: 66L x 53W	\$2,545.00	\$2,179.60
336320	TruckVault Inc.	T-CHSILS1-15S-PC-PL-HP-PW	Silverado Std 1 Dwr Half Width5' 6", All Wthr;Passenger Side	\$2,545.00	\$2,179.60
336320	TruckVault Inc.	T-CHSILS1-19S-HD	Silverado Std 1 Dwr Half Width	\$2,495.00	\$2,136.78
336320	TruckVault Inc.	T-CHSILS1-19S-PC-HD-PW	Silverado Std 1 Dwr Half Width	\$2,545.00	\$2,179.60
336320	TruckVault Inc.	T-CHSILS1-19S-PC-HP	Silverado Std 1 Dwr Half Width5' 8" Bed, Passenger Side	\$2,215.00	\$1,896.98
336320	TruckVault Inc.	T-CHSILS1-19S-PC-HP-PW	Silverado Std 1 Dwr Half Width	\$2,545.00	\$2,179.60
336320	TruckVault Inc.	T-CHSILS1-20S-P5-HD-PW	Silverado Std 1 Dwr Half Width6", All Wthr; Drivers Side	\$2,845.00	\$2,436.52
336320	TruckVault Inc.	T-CHSILS1-20S-P5-HP	Silverado 2500/3500 Pickup Standard 1 Dwr6' 8" Short Bed 1/2 width Passenger Side	\$2,325.00	\$1,991.18
336320	TruckVault Inc.	T-CHSILS1-20S-P5-HP-PW	Silverado Std 1 Dwr Half Width6", All Wthr; Passenger Side	\$2,845.00	\$2,436.52
336320	TruckVault Inc.	T-CHSILS1-20S-P5-PL-HD-PW	Silverado Std 1 Dwr Half Width6", All Wthr; Drivers Side Logo	\$2,845.00	\$2,436.52
336320	TruckVault Inc.	T-CHSILS1-20S-P5-PL-HP	Silverado 2500/3500 Pickup Standard 1 Dwr6' 8" Short Bed 1/2 width Passanger Side	\$2,325.00	\$1,991.18
336320	TruckVault Inc.	T-CHSILS1-20S-P5-PL-HP-PW	Silverado Std 1 Dwr Half Width6", All Wthr; Passenger Side	\$2,845.00	\$2,436.52
336320	TruckVault Inc.	T-CHSILS2-04S-PC	Chevrolet Silverado Pickup Std 2 Dwr, dimensions: 65.5L x 53W	\$3,345.00	\$2,864.74
336320	TruckVault Inc.	T-CHSILS2-04S-PC-PW	Chevrolet Silverado Pickup Std 2 Dwr, dimensions: 68L x 49.25W	\$4,145.00	\$3,549.87
336320	TruckVault Inc.	T-CHSILS2-07L	Chevrolet Silverado Pickup Std 2 Dwr, dimensions: 96L x 48W	\$3,745.00	\$3,207.30
336320	TruckVault Inc.	T-CHSILS2-07L-HT	Silverado Pickup Std 2 Dwr	\$4,440.00	\$3,802.52
336320	TruckVault Inc.	T-CHSILS2-07L-PT	Chevrolet Silverado Pickup Std 2 Dwr, dimensions: 96L x 48W	\$4,440.00	\$3,802.52
336320	TruckVault Inc.	T-CHSILS2-07L-PW	Chevrolet Silverado Pickup Std 2 Dwr, dimensions: 96L x 48W	\$4,745.00	\$4,063.73
336320	TruckVault Inc.	T-CHSILS2-07S	Chevrolet Silverado Pickup Std 2 Dwr, dimensions: 76L x 48W	\$3,545.00	\$3,036.02
336320	TruckVault Inc.	T-CHSILS2-07S-PC	Chevrolet Silverado Pickup Std 2 Dwr, dimensions: 66L x 53W	\$3,345.00	\$2,864.74
336320	TruckVault Inc.	T-CHSILS2-07S-PC-PT	Chevrolet Silverado Pickup Std 2 Dwr, dimensions: 66L x 53W	\$4,040.00	\$3,459.95
336320	TruckVault Inc.	T-CHSILS2-07S-PC-PW	Chevrolet Silverado Pickup Std 2 Dwr, dimensions: 66L x 53W	\$4,145.00	\$3,549.87
336320	TruckVault Inc.	T-CHSILS2-07S-PT	Chevrolet Silverado Pickup Std 2 Dwr, dimensions: 77L x 53W	\$4,240.00	\$3,631.23
336320	TruckVault Inc.	T-CHSILS2-07S-PW	Chevrolet Silverado Pickup Std 2 Dwr, dimensions: 77L x 48W	\$4,445.00	\$3,806.80
336320	TruckVault Inc.	T-CHSILS2-07S-ZC8436	Silverado Pickup Std 2 Dwr	\$3,615.00	\$3,095.97
336320	TruckVault Inc.	T-CHSILS2-15L-PL	Chevrolet Silverado Pickup Std 2 Dwr, dimensions: 94L x 48W	\$3,745.00	\$3,207.30
336320	TruckVault Inc.	T-CHSILS2-15L-PL-PW	Silverado Pickup Std 2 Dwr	\$4,745.00	\$4,063.73
336320	TruckVault Inc.	T-CHSILS2-15S-PC-PL	Chevrolet Silverado Pickup Std 2 Dwr, dimensions: 65L x 53W	\$3,345.00	\$2,864.74
336320	TruckVault Inc.	T-CHSILS2-15S-PC-PL-PW	Chevrolet Silverado Pickup Std 2 Dwr, dimensions: 67L x 48W	\$4,145.00	\$3,549.87
336320	TruckVault Inc.	T-CHSILS2-15S-PL	Chevrolet Silverado Pickup Std 2 Dwr, dimensions: 75L x 48W	\$3,545.00	\$3,036.02
336320	TruckVault Inc.	T-CHSILS2-15S-PL-PW	Chevrolet Silverado Pickup Std 2 Dwr, dimensions: 75L x 48W	\$4,445.00	\$3,806.80

336320	TruckVault Inc.	T-CHSILS2-19L	Silverado Pickup Std 2 Dwr8' Long Bed (New)	\$3,745.00	\$3,207.30
336320	TruckVault Inc.	T-CHSILS2-19L-PW	Silverado Pickup Std 2 Dwr	\$4,745.00	\$4,063.73
336320	TruckVault Inc.	T-CHSILS2-19S	Silverado Pickup Standard 2 Dwr	\$3,545.00	\$3,036.02
336320	TruckVault Inc.	T-CHSILS2-19S-PC	Silverado Pickup Std 2 Dwr	\$3,345.00	\$2,864.74
336320	TruckVault Inc.	T-CHSILS2-19S-PC-PW	Silverado Pickup Std 2 Dwr	\$4,145.00	\$3,549.87
336320	TruckVault Inc.	T-CHSILS2-19S-PW	Silverado Pickup Std 2 Dwr	\$4,445.00	\$3,806.80
336320	TruckVault Inc.	T-CHSILS2-19S-PW-ZC8565	Silverado Pickup Std 2 Dwr	\$4,855.00	\$4,157.93
336320	TruckVault Inc.	T-CHSILS2-20L-P5-PL-PW	Silverado 2500/3500 Pickup Std Dwr8' Long Bed, A-Wthr Logo	\$4,745.00	\$4,063.73
336320	TruckVault Inc.	T-CHSILS2-20L-P5-PW	Silverado 2500/3500 Pickup Std Dwr8' Long Bed, A-Wthr	\$4,745.00	\$4,063.73
336320	TruckVault Inc.	T-CHSILS2-20L-PL-P5	Silverado Pickup Std 2 Dwr8' Long Bed 2500	\$3,745.00	\$3,207.30
336320	TruckVault Inc.	T-CHSILS2-20S-P5	Silverado 2500/3500 Pickup Standard 2 Dwr6' 8" Short Bed	\$3,545.00	\$3,036.02
336320	TruckVault Inc.	T-CHSILS2-20S-P5-PL	Silverado 2500/3500 Pickup Standard 2 Dwr6' 8" Short Bed	\$3,545.00	\$3,036.02
336320	TruckVault Inc.	T-CHSILS2-20S-P5-PL-PW	Silverado Pickup Std 2 Dwr6' 8" Short Bed, A-Wthr Logo	\$4,445.00	\$3,806.80
336320	TruckVault Inc.	T-CHSILS2-20S-P5-PW	Silverado Pickup Std 2 Dwr6' 8" Short Bed, A-Wthr	\$4,445.00	\$3,806.80
336320	TruckVault Inc.	T-CHSILS2-20S-P5-PW-RX	Silverado Pickup Std 2 Dwr	\$4,145.00	\$3,549.87
336320	TruckVault Inc.	T-CHSILS2-20S-P5-RX	Silverado 2500/3500 Pickup Strd 2 Dwr	\$3,125.00	\$2,676.32
336320	TruckVault Inc.	T-CHSILS2-20S-P5-ZC11707	Silverado 2500/3500 Pickup Standard 2 Dwr	\$3,245.00	\$2,779.09
336320	TruckVault Inc.	T-CHSILS3-07L-P5-PW-ZC11075	Silverado 2500/3500 Pickup Std GooseneckLongbed, A-Wthr C11075	\$5,245.00	\$4,491.94
336320	TruckVault Inc.	T-CHSILS3-07S-C2-PW-ZC10939	Silverado Pickup Std 3 DwrGooseneck; All Weather; Shortened for Tank	\$4,645.00	\$3,978.09
336320	TruckVault Inc.	T-CHSILS3-07S-C2-PW-ZC11592	Silverado PU CUST Std 3 Dwr	\$4,945.00	\$4,235.01
336320	TruckVault Inc.	T-CHSILS3-07S-P5-C1-PW-ZC11319	Silverado 2500/3500 Pickup Std GooseneckShortbed, A-Wthr Shortened for ReTrax	\$4,645.00	\$3,978.09
336320	TruckVault Inc.	T-CHSILS3-07S-PW-ZC11795	Silverado 2500/3500 Pickup Std Gooseneck	\$4,945.00	\$4,235.01
336320	TruckVault Inc.	T-CHSILS3-15S-C2-PW-ZC9214	Silverado PU CUST Std 3 Dwr	\$4,945.00	\$4,235.01
336320	TruckVault Inc.	T-CHSILS3-20L-P5-C2-PW-ZC11701	Silverado 2500/3500 Pickup Std Gooseneck	\$4,645.00	\$3,978.09
336320	TruckVault Inc.	T-CHSILS3-20L-P5-PW-ZC10265	Silverado 2500/3500 Pickup Std Gooseneck8' Long Bed, A-Wthr C10547	\$5,245.00	\$4,491.94
336320	TruckVault Inc.	T-CHSILS3-20L-P5-PW-ZC10547	Silverado 2500/3500 Pickup Std Gooseneck8' Long Bed, A-Wthr C10547	\$5,245.00	\$4,491.94
336320	TruckVault Inc.	T-CHSILS3-20L-P5-PW-ZC10780	Silverado 2500/3500 Pickup Std GooseneckLongbed, A-Wthr C10780	\$5,245.00	\$4,491.94
336320	TruckVault Inc.	T-CHSILS3-20S-P5-PW-ZC10266	Silverado 2500/3500 Pickup Std GooseneckShortbed, A-Wthr C10266	\$4,945.00	\$4,235.01
336320	TruckVault Inc.	T-CHSILS3-99S-C2-PW-ZC11663	Silverado PU CUST Std 3 Dwr	\$4,945.00	\$4,235.01
336320	TruckVault Inc.	T-CHSILSO-04S-PC	Chevrolet Silverado Pickup Std OS Dwr, dimensions: 54.5L x 53W	\$3,145.00	\$2,693.45
336320	TruckVault Inc.	T-CHSILSO-04S-PC-PW	Chevrolet Silverado Pickup Std OS Dwr, dimensions: 68L x 53W	\$4,145.00	\$3,549.87
336320	TruckVault Inc.	T-CHSILSO-07L	Chevrolet Silverado Pickup Std OS Dwr, dimensions: 96L x 48W	\$3,745.00	\$3,207.30
336320	TruckVault Inc.	T-CHSILSO-07L-PW	Chevrolet Silverado Pickup Std OS Dwr, dimensions: 96L x 48W	\$4,745.00	\$4,063.73
336320	TruckVault Inc.	T-CHSILSO-07S	Chevrolet Silverado Pickup Std OS Dwr, dimensions: 76L x 48W	\$3,545.00	\$3,036.02
336320	TruckVault Inc.	T-CHSILSO-07S-PC	Chevrolet Silverado Pickup Std OS Dwr, dimensions: 66L x 53W	\$3,345.00	\$2,864.74
336320	TruckVault Inc.	T-CHSILSO-07S-PC-PT	Chevrolet Silverado Pickup Std O Dwr, dimensions: 66L x 53W	\$4,040.00	\$3,459.95
336320	TruckVault Inc.	T-CHSILSO-07S-PC-PW	Chevrolet Silverado Pickup Std OS Dwr, dimensions: 68L x 48W	\$4,145.00	\$3,549.87
336320	TruckVault Inc.	T-CHSILSO-07S-PW	Chevrolet Silverado Pickup Std OS Dwr, dimensions: 77L x 48W	\$4,445.00	\$3,806.80
336320	TruckVault Inc.	T-CHSILSO-07S-RX	Silverado Pickup Std OS Dwr6 1/2 Bed, Crew Cab (ReTrax)	\$3,345.00	\$2,864.74
336320	TruckVault Inc.	T-CHSILSO-15S-PC-PL	Silverado Pickup Std OS Dwr	\$3,345.00	\$2,864.74
336320	TruckVault Inc.	T-CHSILSO-15S-PC-PL-PW	Silverado Pickup Std OS Dwr	\$4,145.00	\$3,549.87
336320	TruckVault Inc.	T-CHSILSO-15S-PL	Chevrolet Silverado Pickup Std OS Dwr, dimensions: 75L x 48W	\$3,545.00	\$3,036.02
336320	TruckVault Inc.	T-CHSILSO-15S-PL-PW	Silverado Pickup Std OS Dwr	\$4,445.00	\$3,806.80
336320	TruckVault Inc.	T-CHSILSO-19S	Silverado Pickup Standard Offset Dwr	\$3,545.00	\$3,036.02
336320	TruckVault Inc.	T-CHSILSO-19S-PC	Silverado Pickup Std OS Dwr	\$3,345.00	\$2,864.74
336320	TruckVault Inc.	T-CHSILSO-19S-PC-PW	Silverado Pickup Std OS Dwr	\$4,145.00	\$3,549.87
336320	TruckVault Inc.	T-CHSILSO-19S-PW	Silverado Pickup Std OS Dwr	\$4,445.00	\$3,806.80
336320	TruckVault Inc.	T-CHSILSO-20L-P5-PL-PW	Silverado 2500/3500 Pickup Std OS Dwr8' Long Bed, A-Wthr Logo	\$4,445.00	\$3,806.80
336320	TruckVault Inc.	T-CHSILSO-20L-P5-PW	Silverado 2500/3500 Pickup Std OS Dwr8' Long Bed, A-Wthr	\$4,745.00	\$4,063.73
336320	TruckVault Inc.	T-CHSILSO-20S-P5	Silverado 2500/3500 Pickup Standard 2 Dwr offset6' 8" Short Bed	\$3,545.00	\$3,036.02
336320	TruckVault Inc.	T-CHSILSO-20S-P5-PL	Silverado 2500/3500 Pickup Standard 2 Dwr offset6' 8" Short Bed	\$3,545.00	\$3,036.02
336320	TruckVault Inc.	T-CHSILSO-20S-P5-PL-PW	Silverado Pickup Std 2 Dwr Offset6' 8" Short Bed, A-Wthr Logo	\$4,445.00	\$3,806.80
336320	TruckVault Inc.	T-CHSILSO-20S-P5-PW	Silverado Pickup Std 2 Dwr Offset6' 8" Short Bed, A-Wthr	\$4,445.00	\$3,806.80
336320	TruckVault Inc.	T-CHSILSO-20S-P5-PW-RX	Silverado Pickup Std 2 Dwr Offset	\$4,025.00	\$3,447.10
336320	TruckVault Inc.	T-CHSILU0-20S-P5	Silverado 2500/3500 Utility 2 Dwr Offset	\$3,645.00	\$3,121.66
336320	TruckVault Inc.	T-CHSILU1-07L-HD	Silverado Utility 1 Dwr Half Width	\$2,545.00	\$2,179.60
336320	TruckVault Inc.	T-CHSILU1-07S-HD-PW	Silverado Utility 1 Dwr Half Width	\$2,925.00	\$2,505.04
336320	TruckVault Inc.	T-CHSILU1-07S-HP	Silverado Utility 1 Dwr Half Width	\$2,225.00	\$1,905.54
336320	TruckVault Inc.	T-CHSILU1-07S-HP-PW	Silverado Utility 1 Dwr Half Width	\$2,945.00	\$2,522.17

336320	TruckVault Inc.	T-CHSILU1-07S-PC-HD-PW	Silverado Utility 1 Dwr Half Width5' 8", All Wthr; Driver Side	\$2,645.00	\$2,265.24
336320	TruckVault Inc.	T-CHSILU1-07S-PC-HP-PW	Silverado Utility 1 Dwr Half Width	\$2,645.00	\$2,265.24
336320	TruckVault Inc.	T-CHSILU1-15S-PC-PL-HP	SilveradoUtility 1 Dwr Half Width5' 8" Bed, Passenger Side	\$2,325.00	\$1,991.18
336320	TruckVault Inc.	T-CHSILU1-15S-PL-HD	Silverado Utility 1 Dwr Half Width	\$2,395.00	\$2,051.13
336320	TruckVault Inc.	T-CHSILU1-15S-PL-HP	Silverado Utility 1 Dwr Half Width	\$2,395.00	\$2,051.13
336320	TruckVault Inc.	T-CHSILU1-19S-HP-PW	Silverado Utility 1 Dwr Half Width	\$2,645.00	\$2,265.24
336320	TruckVault Inc.	T-CHSILU1-19S-PC-HP-PW	Silverado Utility 1 Dwr Half Width5' 6", All Wthr;Passenger Side	\$2,645.00	\$2,265.24
336320	TruckVault Inc.	T-CHSILU1-20L-P5-PL-HP-PW	Silverado Utility 1 Dwr Half Width96", All Wthr; Passenger Side	\$3,145.00	\$2,693.45
336320	TruckVault Inc.	T-CHSILU2-07L	Silverado Pickup Utility 2 Dwr	\$3,845.00	\$3,292.95
336320	TruckVault Inc.	T-CHSILU2-07L-PW	Silverado Pickup Utility 2 Dwr	\$4,845.00	\$4,149.37
336320	TruckVault Inc.	T-CHSILU2-07L-PW-ZC10464	Silverado Pickup Utility 2 DwrC10464	\$4,325.00	\$3,704.03
336320	TruckVault Inc.	T-CHSILU2-07S	Chevrolet Silverado Pickup Utility 2 Dwr, dimensions: 76L x 48W	\$3,645.00	\$3,121.66
336320	TruckVault Inc.	T-CHSILU2-07S-PC	Silverado Pickup Utility 2 Dwr	\$3,445.00	\$2,950.38
336320	TruckVault Inc.	T-CHSILU2-07S-PC-PW	Silverado Pickup Utility 2 Dwr	\$4,245.00	\$3,635.52
336320	TruckVault Inc.	T-CHSILU2-07S-PW	Chevrolet Silverado Pickup Utility 2 Dwr, dimensions: 75L x 48W	\$4,545.00	\$3,892.44
336320	TruckVault Inc.	T-CHSILU2-07S-PW-ZC10257	Silverado Pickup Utility 2 DwrC10257	\$4,325.00	\$3,704.03
336320	TruckVault Inc.	T-CHSILU2-15L-PL-PW	Silverado Pickup Utility 2 Dwr	\$4,845.00	\$4,149.37
336320	TruckVault Inc.	T-CHSILU2-15S-PC-PL	Silverado Pickup Utility 2 Dwr	\$3,445.00	\$2,950.38
336320	TruckVault Inc.	T-CHSILU2-15S-PC-PL-PW	Silverado Pickup Utility 2 Dwr	\$4,245.00	\$3,635.52
336320	TruckVault Inc.	T-CHSILU2-15S-PL	Silverado Pickup Utility 2 Dwr	\$3,645.00	\$3,121.66
336320	TruckVault Inc.	T-CHSILU2-15S-PL-PW	Silverado Pickup Utility 2 Dwr	\$4,545.00	\$3,892.44
336320	TruckVault Inc.	T-CHSILU2-19L	Silverado Pickup Utility 2 Dwr8' Long Bed (New)	\$3,845.00	\$3,292.95
336320	TruckVault Inc.	T-CHSILU2-19L-PW	Silverado Pickup Utility 2 Dwr	\$4,845.00	\$4,149.37
336320	TruckVault Inc.	T-CHSILU2-19S	Silverado Pickup Utility 2 Dwr	\$3,645.00	\$3,121.66
336320	TruckVault Inc.	T-CHSILU2-19S-PC	Silverado Pickup Utility 2 Dwr	\$3,445.00	\$2,950.38
336320	TruckVault Inc.	T-CHSILU2-19S-PC-PL-PW	Silverado Pickup Utility 2 Dwr	\$4,245.00	\$3,635.52
336320	TruckVault Inc.	T-CHSILU2-19S-PC-PL-RX-PW	Silverado Pickup Utility 2 Dwr ReTrax	\$3,945.00	\$3,378.59
336320	TruckVault Inc.	T-CHSILU2-19S-PC-PW	Silverado Pickup Utility 2 Dwr	\$4,245.00	\$3,635.52
336320	TruckVault Inc.	T-CHSILU2-19S-PL-PW	Silverado Pickup Utility 2 Dwr	\$4,545.00	\$3,892.44
336320	TruckVault Inc.	T-CHSILU2-19S-PW	Silverado Pickup Utility 2 Dwr	\$4,545.00	\$3,892.44
336320	TruckVault Inc.	T-CHSILU2-20L-P5	Silverado Pickup Utility 2 Dwr8' Long Bed 2500	\$3,845.00	\$3,292.95
336320	TruckVault Inc.	T-CHSILU2-20L-P5-PL	Silverado Pickup Utility 2 Dwr8' Long Bed 2500	\$3,845.00	\$3,292.95
336320	TruckVault Inc.	T-CHSILU2-20L-P5-PL-PW	Silverado 2500/3500 Pickup Utility 2 Dwr	\$4,845.00	\$4,149.37
336320	TruckVault Inc.	T-CHSILU2-20L-P5-ZC10040	Silverado Pickup Utility 2 DwrC10040	\$3,445.00	\$2,950.38
336320	TruckVault Inc.	T-CHSILU2-20L-PL-P5	Silverado Pickup Utility 2 Dwr8' Long Bed 2500	\$3,845.00	\$3,292.95
336320	TruckVault Inc.	T-CHSILU2-20S-P5	Silverado 2500/3500 Pickup Utility 2 Dwr6' 8" Short Bed	\$3,645.00	\$3,121.66
336320	TruckVault Inc.	T-CHSILU2-20S-P5-PL-PW	Silverado 2500/3500 Pickup Utility 2 Dwr6' 8" Short Bed, A-Wthr	\$4,545.00	\$3,892.44
336320	TruckVault Inc.	T-CHSILU2-20S-P5-PW	Silverado 2500/3500 Pickup Utility 2 Dwr6' 8" Short Bed, A-Wthr	\$4,545.00	\$3,892.44
336320	TruckVault Inc.	T-CHSILU2-20S-P5-PW-RX	Silverado Pickup Utility 2 Dwr	\$4,245.00	\$3,635.52
336320	TruckVault Inc.	T-CHSILU3-07S-PC-C2-PW-ZC10651	Silverado PU CUST Utility 3 DwrSB, A-Wthr, Gooseneck;	\$4,745.00	\$4,063.73
336320	TruckVault Inc.	T-CHSILU3-07S-PW-ZC11593	Silverado 2500/3500 Pickup Utility Gooseneck	\$5,045.00	\$4,320.65
336320	TruckVault Inc.	T-CHSILU3-20L-P5-PW-ZC10654	Silverado 2500/3500 Pickup UtilityGooseneck8' Long Bed, A-Wthr C10654	\$5,345.00	\$4,577.58
336320	TruckVault Inc.	T-CHSILU3-20S-P5-PW-ZC11682	Silverado 2500/3500 Pickup Std Gooseneck	\$5,045.00	\$4,320.65
336320	TruckVault Inc.	T-CHSILUO-07L-ZC8208	Silverado Pickup Utility OS Dwr	\$3,385.00	\$2,898.99
336320	TruckVault Inc.	T-CHSILUO-07S	Silverado Pickup Utility OS Dwr	\$3,645.00	\$3,121.66
336320	TruckVault Inc.	T-CHSILUO-07S-PC	Silverado Pickup Utility 2 Dwr Offset	\$3,445.00	\$2,950.38
336320	TruckVault Inc.	T-CHSILUO-07S-PC-PW	Silverado Pickup Utility OS Dwr	\$4,245.00	\$3,635.52
336320	TruckVault Inc.	T-CHSILUO-07S-PW	Silverado Pickup Utility OS Dwr	\$4,545.00	\$3,892.44
336320	TruckVault Inc.	T-CHSILUO-15L-PL-PW	Silverado Pickup Utility OS Dwr	\$4,845.00	\$4,149.37
336320	TruckVault Inc.	T-CHSILUO-15L-PL-PW-ZC8336	Silverado Pickup Utility Cust OS Dwr	\$5,425.00	\$4,646.10
336320	TruckVault Inc.	T-CHSILUO-15S-PL	Silverado Pickup Utility OS Dwr	\$3,645.00	\$3,121.66
336320	TruckVault Inc.	T-CHSILUO-15S-PL-PW	Silverado Pickup Utility OS Dwr	\$4,545.00	\$3,892.44
336320	TruckVault Inc.	T-CHSILUO-19S	Silverado Pickup Utility 2 Dwr Offset	\$3,645.00	\$3,121.66
336320	TruckVault Inc.	T-CHSILUO-19S-PC	Silverado Pickup Utility 2 Dwr Offset	\$3,445.00	\$2,950.38
336320	TruckVault Inc.	T-CHSILUO-19S-PC-PW	Silverado Pickup Utility Offset Dwr	\$4,245.00	\$3,635.52
336320	TruckVault Inc.	T-CHSILUO-19S-PW	Silverado Pickup Utility 2 Dwr Offset	\$4,545.00	\$3,892.44
336320	TruckVault Inc.	T-CHSILUO-20S-P5-PL-PW	Silverado 2500/3500 Pickup Utility 2 Dwr Offset6' 8" Short Bed, A-Wthr	\$4,545.00	\$3,892.44
336320	TruckVault Inc.	T-CHSILUO-20S-P5-PW	Silverado 2500/3500 Pickup Utility 2 Dwr Offset6' 8" Short Bed, A-Wthr	\$4,545.00	\$3,892.44
336320	TruckVault Inc.	T-CHSSEM2-82S-PW	Chevrolet S-10 Pickup Mag 2 Dwr, dimensions: 0L x 0W	\$3,945.00	\$3,378.59
336320	TruckVault Inc.	T-CHSSEM2-97S-PC	S-10 Pickup Mag 2 Dwr	\$3,145.00	\$2,693.45
336320	TruckVault Inc.	T-CHSSEM2-97S-PW	Chevrolet S-10 Pickup Mag 2 Dwr, dimensions: 70L x 40W	\$4,245.00	\$3,635.52
336320	TruckVault Inc.	T-CHSSES2-82S-PW	Chevrolet S-10 Pickup Std 2 Dwr, dimensions: 51L x 38W	\$3,745.00	\$3,207.30

336320	TruckVault Inc.	T-CHSSES2-94S-PW	Chevrolet S-10 Pickup Std 2 Dwr, dimensions: 72L x 39.25W	\$4,345.00	\$3,721.16
336320	TruckVault Inc.	T-CHSSES2-97S-PC-PW	Chevrolet S-10 Pickup Std 2 Dwr, dimensions: 53L x 38W	\$3,745.00	\$3,207.30
336320	TruckVault Inc.	T-CHSSES2-97S-PW	Chevrolet S-10 Pickup Std 2 Dwr, dimensions: 70L x 40W	\$4,045.00	\$3,464.23
336320	TruckVault Inc.	T-CHSSES2-99L-PW	Chevrolet S-10 Pickup Std 2 Dwr, dimensions: 84L x 38W	\$4,645.00	\$3,978.09
336320	TruckVault Inc.	T-CHSSES0-97S-PW	Chevrolet S-10 Pickup Std OS Dwr, dimensions: 70L x 40W	\$4,045.00	\$3,464.23
336320	TruckVault Inc.	T-CHSUBM1-00M	Chevrolet Suburban Mag 1 Dwr, dimensions: 54L x 48W	\$2,295.00	\$1,965.49
336320	TruckVault Inc.	T-CHSUBM1-00S	Chevrolet Suburban Mag 1 Dwr, dimensions: 30L x 48W	\$2,095.00	\$1,794.21
336320	TruckVault Inc.	T-CHSUBM1-00S-PT	Chevrolet Suburban Mag 1 Dwr, dimensions: 29L x 48W	\$2,790.00	\$2,389.42
336320	TruckVault Inc.	T-CHSUBM1-07M	Chevrolet Suburban Mag 1 Dwr, dimensions: 52L x 48W	\$2,435.00	\$2,085.39
336320	TruckVault Inc.	T-CHSUBM1-07M-BS	Chevrolet Suburban Mag 1 Dwr, dimensions: 52L x 48W	\$2,435.00	\$2,085.39
336320	TruckVault Inc.	T-CHSUBM1-07M-PT	Chevrolet Suburban Mag 1 Dwr, dimensions: 52L x 49W	\$3,135.00	\$2,684.89
336320	TruckVault Inc.	T-CHSUBM1-07S	Chevrolet Suburban Mag 1 Dwr, dimensions: 28L x 48W	\$2,095.00	\$1,794.21
336320	TruckVault Inc.	T-CHSUBM1-07S-BS	Chevrolet Suburban Mag 1 Dwr, dimensions: 28L x 49W	\$2,095.00	\$1,794.21
336320	TruckVault Inc.	T-CHSUBM1-07S-HT	Chevrolet Suburban Mag 1 Dwr, dimensions: 27L x 48W	\$2,790.00	\$2,389.42
336320	TruckVault Inc.	T-CHSUBM1-07S-PT	Chevrolet Suburban Mag 1 Dwr, dimensions: 27L x 48W	\$2,790.00	\$2,389.42
336320	TruckVault Inc.	T-CHSUBM1-12F-HP	Chevrolet Suburban Mag 1 Dwr Half Width, dimensions: 60L x 24W	\$2,105.00	\$1,802.77
336320	TruckVault Inc.	T-CHSUBM1-12M	Chevrolet Suburban Mag 1 Dwr, dimensions: 52L x 48W	\$2,435.00	\$2,085.39
336320	TruckVault Inc.	T-CHSUBM1-12S	Chevrolet Suburban Mag 1 Dwr, dimensions: 28L x 48W	\$2,095.00	\$1,794.21
336320	TruckVault Inc.	T-CHSUBM1-12S-PT	Chevrolet Suburban Mag 1 Dwr, dimensions: 27L x 0W	\$2,790.00	\$2,389.42
336320	TruckVault Inc.	T-CHSUBM1-15M	Chevrolet Suburban Mag 1 Dwr, dimensions: 52L x 48W	\$2,435.00	\$2,085.39
336320	TruckVault Inc.	T-CHSUBM1-15M-CR	Chevrolet Suburban Mag 1 Dwr, dimensions: 52L x 48W	\$2,845.00	\$2,436.52
336320	TruckVault Inc.	T-CHSUBM1-15M-HP	Suburban Mag 1 Dwr Half Width	\$2,095.00	\$1,794.21
336320	TruckVault Inc.	T-CHSUBM1-15M-HT	Suburban Mag 1 Dwr	\$3,190.00	\$2,731.99
336320	TruckVault Inc.	T-CHSUBM1-15N-C1-ZC8591	Suburban Custom	\$2,705.00	\$2,316.62
336320	TruckVault Inc.	T-CHSUBM1-15N-ZC8789	Suburban Custom	\$1,575.00	\$1,348.87
336320	TruckVault Inc.	T-CHSUBM1-15S	Chevrolet Suburban Mag 1 Dwr, dimensions: 29L x 48W	\$2,095.00	\$1,794.21
336320	TruckVault Inc.	T-CHSUBM1-15S-HT	Suburban Mag 1 Dwr	\$2,790.00	\$2,389.42
336320	TruckVault Inc.	T-CHSUBM1-15S-PP	Suburban Mag 1 Dwr	\$2,095.00	\$1,794.21
336320	TruckVault Inc.	T-CHSUBM1-15S-TT	Suburban Mag 1 Dwr	\$2,940.00	\$2,517.88
336320	TruckVault Inc.	T-CHSUBM1-88S	Chevrolet Suburban Mag 1 Dwr, dimensions: 32L x 46W	\$2,095.00	\$1,794.21
336320	TruckVault Inc.	T-CHSUBM2-00F	Chevrolet Suburban Mag 2 Dwr, dimensions: 62.5L x 48W	\$3,245.00	\$2,779.09
336320	TruckVault Inc.	T-CHSUBM2-00F-LN	Chevrolet Suburban Mag 2 Dwr, dimensions: 62.5L x 48W	\$3,245.00	\$2,779.09
336320	TruckVault Inc.	T-CHSUBM2-00F-LN-PT	Chevrolet Suburban Mag 2 Dwr, dimensions: 61.5L x 48W	\$3,940.00	\$3,374.31
336320	TruckVault Inc.	T-CHSUBM2-00F-PP	Chevrolet Suburban Mag 2 Dwr, dimensions: 59.5L x 48W	\$3,045.00	\$2,607.81
336320	TruckVault Inc.	T-CHSUBM2-00F-PP-LN	Chevrolet Suburban Mag 2 Dwr, dimensions: 59.5L x 48W	\$3,045.00	\$2,607.81
336320	TruckVault Inc.	T-CHSUBM2-00F-PT	Chevrolet Suburban Mag 2 Dwr, dimensions: 60L x 49W	\$3,940.00	\$3,374.31
336320	TruckVault Inc.	T-CHSUBM2-00F-TC	Chevrolet Suburban Mag 2 Dwr, dimensions: 59.5L x 48W	\$3,045.00	\$2,607.81
336320	TruckVault Inc.	T-CHSUBM2-00F-TC-LN	Chevrolet Suburban Mag 2 Dwr, dimensions: 59.5L x 48W	\$3,045.00	\$2,607.81
336320	TruckVault Inc.	T-CHSUBM2-00M	Chevrolet Suburban Mag 2 Dwr, dimensions: 54L x 48W	\$2,985.00	\$2,556.42
336320	TruckVault Inc.	T-CHSUBM2-00M-BS	Chevrolet Suburban Mag 2 Dwr, dimensions: 52L x 49W	\$2,985.00	\$2,556.42
336320	TruckVault Inc.	T-CHSUBM2-00M-LN	Chevrolet Suburban Mag 2 Dwr, dimensions: 54L x 48W	\$2,985.00	\$2,556.42
336320	TruckVault Inc.	T-CHSUBM2-00S	Chevrolet Suburban Mag 2 Dwr, dimensions: 30L x 48W	\$2,645.00	\$2,265.24
336320	TruckVault Inc.	T-CHSUBM2-07F	Chevrolet Suburban Mag 2 Dwr, dimensions: 60L x 48W	\$3,245.00	\$2,779.09
336320	TruckVault Inc.	T-CHSUBM2-07F-BS	Chevrolet Suburban Mag 2 Dwr, dimensions: 60L x 49W	\$3,245.00	\$2,779.09
336320	TruckVault Inc.	T-CHSUBM2-07F-HT	Suburban Mag 2 Dwr	\$3,740.00	\$3,203.02
336320	TruckVault Inc.	T-CHSUBM2-07F-HT-ZC11456B	Suburban Mag 2 Dwr	\$4,115.00	\$3,524.18
336320	TruckVault Inc.	T-CHSUBM2-07F-PP	Chevrolet Suburban Mag 2 Dwr, dimensions: 57L x 48W	\$3,045.00	\$2,607.81
336320	TruckVault Inc.	T-CHSUBM2-07F-PP-PT	Chevrolet Suburban Mag 2 Dwr Table Ext, dimensions: 56L x 49W	\$3,740.00	\$3,203.02
336320	TruckVault Inc.	T-CHSUBM2-07F-PP-T01	Suburban Mag 2 Dwr	\$3,045.00	\$2,607.81
336320	TruckVault Inc.	T-CHSUBM2-07F-PT	Chevrolet Suburban Mag 2 Dwr, dimensions: 59L x 49W	\$3,740.00	\$3,203.02
336320	TruckVault Inc.	T-CHSUBM2-07M	Chevrolet Suburban Mag 2 Dwr, dimensions: 52L x 48W	\$2,985.00	\$2,556.42
336320	TruckVault Inc.	T-CHSUBM2-07M-BS	Chevrolet Suburban Mag 2 Dwr, dimensions: 52L x 49W	\$2,985.00	\$2,556.42
336320	TruckVault Inc.	T-CHSUBM2-07M-HT	Suburban Mag 2 Dwr	\$3,740.00	\$3,203.02
336320	TruckVault Inc.	T-CHSUBM2-07M-PT	Chevrolet Suburban Mag 2 Dwr, dimensions: 52L x 49W	\$3,685.00	\$3,155.92
336320	TruckVault Inc.	T-CHSUBM2-07S	Chevrolet Suburban Mag 2 Dwr, dimensions: 28L x 48W	\$2,645.00	\$2,265.24
336320	TruckVault Inc.	T-CHSUBM2-07S-BS	Chevrolet Suburban Mag 2 Dwr, dimensions: 28L x 49W	\$2,645.00	\$2,265.24
336320	TruckVault Inc.	T-CHSUBM2-12F	Chevrolet Suburban Mag 2 Dwr, dimensions: 60L x 48W	\$3,245.00	\$2,779.09
336320	TruckVault Inc.	T-CHSUBM2-12F-PP	Chevrolet Suburban Mag 2 Dwr, dimensions: 57L x 48W	\$3,045.00	\$2,607.81
336320	TruckVault Inc.	T-CHSUBM2-12F-PP-PT	Chevrolet Suburban Mag 2 Dwr Table Ext, dimensions: 56L x 49W	\$3,740.00	\$3,203.02
336320	TruckVault Inc.	T-CHSUBM2-12F-PT	Chevrolet Suburban Mag 2 Dwr, dimensions: 59L x 49W	\$3,740.00	\$3,203.02
336320	TruckVault Inc.	T-CHSUBM2-12M	Chevrolet Suburban Mag 2 Dwr, dimensions: 52L x 48W	\$2,985.00	\$2,556.42
336320	TruckVault Inc.	T-CHSUBM2-12S	Chevrolet Suburban Mag 2 Dwr, dimensions: 28L x 48W	\$2,645.00	\$2,265.24
336320	TruckVault Inc.	T-CHSUBM2-12S-PT	Chevrolet Suburban Mag 2 Dwr, dimensions: 27L x 49W	\$3,340.00	\$2,860.45
336320	TruckVault Inc.	T-CHSUBM2-15F	Chevrolet Suburban Mag 2 Dwr, dimensions: 60L x 48W	\$3,245.00	\$2,779.09
336320	TruckVault Inc.	T-CHSUBM2-15F-CR	Chevrolet Suburban Mag 2 Dwr, dimensions: 56L x 48W	\$3,395.00	\$2,907.56
336320	TruckVault Inc.	T-CHSUBM2-15F-HT	Suburban Mag 2 Dwr	\$3,740.00	\$3,203.02
336320	TruckVault Inc.	T-CHSUBM2-15F-PP	Chevrolet Suburban Mag 2 Dwr, dimensions: 57L x 48W	\$3,045.00	\$2,607.81

336320	TruckVault Inc.	T-CHSUBM2-15F-PT	Suburban Mag 2 DwrF-Size, Tbl Ext	\$3,740.00	\$3,203.02
336320	TruckVault Inc.	T-CHSUBM2-15F-TT	Suburban Mag 2 Dwr	\$3,965.00	\$3,395.72
336320	TruckVault Inc.	T-CHSUBM2-15M	Chevrolet Suburban Mag 2 Dwr, dimensions: 52L x 48W	\$2,985.00	\$2,556.42
336320	TruckVault Inc.	T-CHSUBM2-15M-CR	Chevrolet Suburban Mag 2 Dwr, dimensions: 52L x 48W	\$3,395.00	\$2,907.56
336320	TruckVault Inc.	T-CHSUBM2-15S	Chevrolet Suburban Mag 2 Dwr, dimensions: 29L x 48W	\$2,645.00	\$2,265.24
336320	TruckVault Inc.	T-CHSUBM2-15S-PP	Suburban Mag 2 Dwr	\$2,645.00	\$2,265.24
336320	TruckVault Inc.	T-CHSUBM2-21F-TF	Suburban Mag 2 DwrF-Size, 3rd Seat Folded	\$3,045.00	\$2,607.81
336320	TruckVault Inc.	T-CHSUBM2-21F-TR	Suburban Mag 2 Dwr	\$3,045.00	\$2,607.81
336320	TruckVault Inc.	T-CHSUBM2-88F	Chevrolet Suburban Mag 2 Dwr, dimensions: 62.5L x 46W	\$3,245.00	\$2,779.09
336320	TruckVault Inc.	T-CHSUBM2-88F-BS	Chevrolet Suburban Mag 2 Dwr, dimensions: 59.5L x 46W	\$3,045.00	\$2,607.81
336320	TruckVault Inc.	T-CHSUBM2-88F-PT	Chevrolet Suburban Mag 2 Dwr, dimensions: 62.5L x 46W	\$3,940.00	\$3,374.31
336320	TruckVault Inc.	T-CHSUBM2-88M	Chevrolet Suburban Mag 2 Dwr, dimensions: 54L x 46W	\$3,045.00	\$2,607.81
336320	TruckVault Inc.	T-CHSUBM2-88S	Chevrolet Suburban Mag 2 Dwr, dimensions: 32L x 46W	\$2,645.00	\$2,265.24
336320	TruckVault Inc.	T-CHSUBMO-00F	Chevrolet Suburban Mag OS Dwr, dimensions: 62.5L x 48W	\$3,245.00	\$2,779.09
336320	TruckVault Inc.	T-CHSUBMO-00F-HT	Suburban Mag OS Dwr	\$3,740.00	\$3,203.02
336320	TruckVault Inc.	T-CHSUBMO-00F-LN	Chevrolet Suburban Mag OS Dwr, dimensions: 62.5L x 48W	\$3,245.00	\$2,779.09
336320	TruckVault Inc.	T-CHSUBMO-00F-PP	Chevrolet Suburban Mag OS Dwr, dimensions: 59.5L x 48W	\$3,045.00	\$2,607.81
336320	TruckVault Inc.	T-CHSUBMO-00F-PP-LN	Chevrolet Suburban Mag OS Dwr, dimensions: 59.5L x 48W	\$3,045.00	\$2,607.81
336320	TruckVault Inc.	T-CHSUBMO-00F-PT	Chevrolet Suburban Mag OS Dwr, dimensions: 61L x 49W	\$3,940.00	\$3,374.31
336320	TruckVault Inc.	T-CHSUBMO-00F-TC	Chevrolet Suburban Mag OS Dwr, dimensions: 59.5L x 48W	\$3,045.00	\$2,607.81
336320	TruckVault Inc.	T-CHSUBMO-00F-TC-LN	Chevrolet Suburban Mag OS Dwr, dimensions: 59.5L x 48W	\$3,045.00	\$2,607.81
336320	TruckVault Inc.	T-CHSUBMO-00M	Chevrolet Suburban Mag OS Dwr, dimensions: 54L x 48W	\$3,045.00	\$2,607.81
336320	TruckVault Inc.	T-CHSUBMO-00M-LN	Chevrolet Suburban Mag OS Dwr, dimensions: 54L x 48W	\$3,045.00	\$2,607.81
336320	TruckVault Inc.	T-CHSUBMO-00M-PT	Chevrolet Suburban Mag OS Dwr, dimensions: 54L x 49W	\$3,740.00	\$3,203.02
336320	TruckVault Inc.	T-CHSUBMO-00S	Chevrolet Suburban Mag OS Dwr, dimensions: 30L x 48W	\$2,645.00	\$2,265.24
336320	TruckVault Inc.	T-CHSUBMO-07F	Chevrolet Suburban Mag OS Dwr, dimensions: 60L x 48W	\$3,245.00	\$2,779.09
336320	TruckVault Inc.	T-CHSUBMO-07F-PT	Chevrolet Suburban Mag OS Dwr, dimensions: 59L x 48W	\$3,740.00	\$3,203.02
336320	TruckVault Inc.	T-CHSUBMO-07F-PT-BS	Chevrolet Suburban Mag OS Dwr, dimensions: 56L x 48W	\$3,740.00	\$3,203.02
336320	TruckVault Inc.	T-CHSUBMO-07F-PT-PP	Chevrolet Suburban Mag OS Dwr, dimensions: 56L x 48W	\$3,740.00	\$3,203.02
336320	TruckVault Inc.	T-CHSUBMO-07M	Chevrolet Suburban Mag OS Dwr, dimensions: 52L x 48W	\$2,985.00	\$2,556.42
336320	TruckVault Inc.	T-CHSUBMO-07M-PT	Chevrolet Suburban Mag OS Dwr, dimensions: 52L x 48W	\$3,685.00	\$3,155.92
336320	TruckVault Inc.	T-CHSUBMO-07S	Chevrolet Suburban Mag OS Dwr, dimensions: 28L x 48W	\$2,645.00	\$2,265.24
336320	TruckVault Inc.	T-CHSUBMO-07S-HT	Suburban Mag OS DwrS-Size, HD Table Ext	\$3,340.00	\$2,860.45
336320	TruckVault Inc.	T-CHSUBMO-07S-PT	Chevrolet Suburban Mag OS Dwr, dimensions: 27L x 48W	\$3,340.00	\$2,860.45
336320	TruckVault Inc.	T-CHSUBMO-12F	Chevrolet Suburban Mag OS Dwr, dimensions: 60L x 48W	\$3,245.00	\$2,779.09
336320	TruckVault Inc.	T-CHSUBMO-12F-PP	Chevrolet Suburban Mag OS Dwr, dimensions: 57L x 48W	\$3,045.00	\$2,607.81
336320	TruckVault Inc.	T-CHSUBMO-12F-PT	Chevrolet Suburban Mag OS Dwr, dimensions: 59L x 48W	\$3,740.00	\$3,203.02
336320	TruckVault Inc.	T-CHSUBMO-12F-PT-PP	Chevrolet Suburban Mag OS Dwr, dimensions: 56L x 49W	\$3,740.00	\$3,203.02
336320	TruckVault Inc.	T-CHSUBMO-12M	Chevrolet Suburban Mag OS Dwr, dimensions: 52L x 48W	\$2,985.00	\$2,556.42
336320	TruckVault Inc.	T-CHSUBMO-12M-PT	Chevrolet Suburban Mag OS Dwr, dimensions: 52L x 49W	\$3,685.00	\$3,155.92
336320	TruckVault Inc.	T-CHSUBMO-12S	Chevrolet Suburban Mag OS Dwr, dimensions: 28L x 48W	\$2,645.00	\$2,265.24
336320	TruckVault Inc.	T-CHSUBMO-15F	Chevrolet Suburban Mag OS Dwr, dimensions: 60L x 48W	\$3,245.00	\$2,779.09
336320	TruckVault Inc.	T-CHSUBMO-15F-CR	Chevrolet Suburban Mag OS Dwr, dimensions: 56L x 48W	\$3,395.00	\$2,907.56
336320	TruckVault Inc.	T-CHSUBMO-15F-HT	Suburban Mag Offset Dwr	\$3,740.00	\$3,203.02
336320	TruckVault Inc.	T-CHSUBMO-15F-PP	Chevrolet Suburban Mag 2 Dwr, dimensions: 57L x 48W	\$3,045.00	\$2,607.81
336320	TruckVault Inc.	T-CHSUBMO-15M	Chevrolet Suburban Mag OS Dwr, dimensions: 52L x 48W	\$2,985.00	\$2,556.42
336320	TruckVault Inc.	T-CHSUBMO-15M-CR	Chevrolet Suburban Mag OS Dwr, dimensions: 52L x 49W	\$3,395.00	\$2,907.56
336320	TruckVault Inc.	T-CHSUBMO-15S	Chevrolet Suburban Mag OS Dwr, dimensions: 28L x 48W	\$2,645.00	\$2,265.24
336320	TruckVault Inc.	T-CHSUBMO-21F-TF	Suburban Mag OS Dwr	\$2,925.00	\$2,505.04
336320	TruckVault Inc.	T-CHSUBMO-88F	Chevrolet Suburban Mag OS Dwr, dimensions: 62.5L x 46W	\$3,245.00	\$2,779.09
336320	TruckVault Inc.	T-CHSUBMO-88F-PT	Chevrolet Suburban Mag OS Dwr, dimensions: 61L x 46W	\$3,940.00	\$3,374.31
336320	TruckVault Inc.	T-CHSUBMO-88M	Chevrolet Suburban Mag OS Dwr, dimensions: 54L x 46W	\$3,045.00	\$2,607.81
336320	TruckVault Inc.	T-CHSUBN1-07N-ZC11422	Suburban Custom 1 Dwr	\$2,225.00	\$1,905.54
336320	TruckVault Inc.	T-CHSUBN1-15M-ZC8147	Suburban CUST 1 Dwr	\$1,685.00	\$1,443.07
336320	TruckVault Inc.	T-CHSUBN2-15N-C1-ZC11653C	Suburban Custom	\$3,445.00	\$2,950.38
336320	TruckVault Inc.	T-CHSUBN2-15N-ZC10123	Suburban Custom 2 DwrC10123	\$3,065.00	\$2,624.94
336320	TruckVault Inc.	T-CHSUBN2-15N-ZC10899	Suburban Custom 2 DwrC10899	\$3,635.00	\$3,113.10
336320	TruckVault Inc.	T-CHSUBN2-21N-TF-ZC11575	Suburban Custom 2 Dwr	\$3,025.00	\$2,590.68
336320	TruckVault Inc.	T-CHSUBS1-00F-HP	Suburban Std 1/2 Width 1 Dwr Passenger Side	\$1,885.00	\$1,614.36
336320	TruckVault Inc.	T-CHSUBS1-00M	Chevrolet Suburban Std 1 Dwr, dimensions: 54L x 48W	\$2,215.00	\$1,896.98
336320	TruckVault Inc.	T-CHSUBS1-00M-LN	Chevrolet Suburban Std 1 Dwr, dimensions: 54L x 48W	\$2,215.00	\$1,896.98
336320	TruckVault Inc.	T-CHSUBS1-00N-ZC9502	Suburban Std 1 Dwr	\$2,135.00	\$1,828.46
336320	TruckVault Inc.	T-CHSUBS1-00S	Chevrolet Suburban Std 1 Dwr, dimensions: 30L x 48W	\$1,895.00	\$1,622.92
336320	TruckVault Inc.	T-CHSUBS1-00S-PT	Chevrolet Suburban Std 1 Dwr, dimensions: 30L x 48W	\$2,590.00	\$2,218.14
336320	TruckVault Inc.	T-CHSUBS1-07M	Chevrolet Suburban Std 1 Dwr, dimensions: 52L x 48W	\$2,215.00	\$1,896.98
336320	TruckVault Inc.	T-CHSUBS1-07M-PT	Chevrolet Suburban Std 1 Dwr, dimensions: 52L x 48W	\$2,915.00	\$2,496.47
336320	TruckVault Inc.	T-CHSUBS1-07N-ZC8826	Suburban Custom 1 Dwr	\$2,135.00	\$1,828.46
336320	TruckVault Inc.	T-CHSUBS1-07S	Chevrolet Suburban Std 1 Dwr, dimensions: 28L x 48W	\$1,895.00	\$1,622.92
336320	TruckVault Inc.	T-CHSUBS1-07S-PT	Chevrolet Suburban Std 1 Dwr, dimensions: 27L x 48W	\$2,590.00	\$2,218.14



336320	TruckVault Inc.	T-CHSUBS1-12M	Chevrolet Suburban Std 1 Dwr, dimensions: 52L x 48W	\$2,215.00	\$1,896.98
336320	TruckVault Inc.	T-CHSUBS1-12S	Chevrolet Suburban Std 1 Dwr, dimensions: 28L x 48W	\$1,895.00	\$1,622.92
336320	TruckVault Inc.	T-CHSUBS1-12S-PT	Chevrolet Suburban Std 1 Dwr, dimensions: 27L x 48W	\$2,590.00	\$2,218.14
336320	TruckVault Inc.	T-CHSUBS1-15F-CR-HD	Suburban Std 1/2 Width 1 Dwr Driver Side	\$2,245.00	\$1,922.67
336320	TruckVault Inc.	T-CHSUBS1-15M	Chevrolet Suburban Std 1 Dwr, dimensions: 52L x 48W	\$2,215.00	\$1,896.98
336320	TruckVault Inc.	T-CHSUBS1-15M-CR	Chevrolet Suburban Std 1 Dwr, dimensions: 52L x 48W	\$2,605.00	\$2,230.98
336320	TruckVault Inc.	T-CHSUBS1-15S	Chevrolet Suburban Std 1 Dwr, dimensions: 29L x 48W	\$1,895.00	\$1,622.92
336320	TruckVault Inc.	T-CHSUBS1-15S-HT	Suburban Std 1 Dwr	\$2,590.00	\$2,218.14
336320	TruckVault Inc.	T-CHSUBS1-15S-PP	Suburban Std 1 Dwr	\$1,895.00	\$1,622.92
336320	TruckVault Inc.	T-CHSUBS1-15S-PT	Suburban Std 1 DwrS-Size, Table Ext	\$2,590.00	\$2,218.14
336320	TruckVault Inc.	T-CHSUBS1-15S-TT	Suburban Std 1 Dwr	\$2,740.00	\$2,346.60
336320	TruckVault Inc.	T-CHSUBS1-21S	Suburban Std 1 DwrS-Size, 3rd Seat Upright	\$1,895.00	\$1,622.92
336320	TruckVault Inc.	T-CHSUBS1-88S	Chevrolet Suburban Std 1 Dwr, dimensions: 32L x 48W	\$1,895.00	\$1,622.92
336320	TruckVault Inc.	T-CHSUBS1-88S-PT	Chevrolet Suburban Std 1 Dwr, dimensions: 31L x 48W	\$2,590.00	\$2,218.14
336320	TruckVault Inc.	T-CHSUBS2-00F	Chevrolet Suburban Std 2 Dwr, dimensions: 62.5L x 48W	\$2,985.00	\$2,556.42
336320	TruckVault Inc.	T-CHSUBS2-00F-LN	Chevrolet Suburban Std 2 Dwr, dimensions: 62.5L x 48W	\$2,985.00	\$2,556.42
336320	TruckVault Inc.	T-CHSUBS2-00F-PT	Chevrolet Suburban Std 2 Dwr, dimensions: 62.5L x 48W	\$3,685.00	\$3,155.92
336320	TruckVault Inc.	T-CHSUBS2-00M	Chevrolet Suburban Std 2 Dwr, dimensions: 54L x 48W	\$2,845.00	\$2,436.52
336320	TruckVault Inc.	T-CHSUBS2-00M-LN	Chevrolet Suburban Std 2 Dwr, dimensions: 54L x 48W	\$2,845.00	\$2,436.52
336320	TruckVault Inc.	T-CHSUBS2-00M-PT	Chevrolet Suburban Std 2 Dwr, dimensions: 54L x 48W	\$3,540.00	\$3,031.74
336320	TruckVault Inc.	T-CHSUBS2-00S	Chevrolet Suburban Std 2 Dwr, dimensions: 30L x 48W	\$2,445.00	\$2,093.95
336320	TruckVault Inc.	T-CHSUBS2-07F	Chevrolet Suburban Std 2 Dwr, dimensions: 60L x 48W	\$2,985.00	\$2,556.42
336320	TruckVault Inc.	T-CHSUBS2-07F-BS	Chevrolet Suburban Std 2 Dwr, dimensions: 60L x 48W	\$2,985.00	\$2,556.42
336320	TruckVault Inc.	T-CHSUBS2-07F-PP	Chevrolet Suburban Std 2 Dwr, dimensions: 57L x 48W	\$2,845.00	\$2,436.52
336320	TruckVault Inc.	T-CHSUBS2-07F-PP-PT	Chevrolet Suburban Std 2 Dwr, dimensions: 57L x 48W	\$3,540.00	\$3,031.74
336320	TruckVault Inc.	T-CHSUBS2-07F-PT	Chevrolet Suburban Std 2 Dwr, dimensions: 60L x 48W	\$3,685.00	\$3,155.92
336320	TruckVault Inc.	T-CHSUBS2-07F-PW	Chevrolet Suburban Std 2 Dwr, dimensions: 60L x 48W	\$3,045.00	\$2,607.81
336320	TruckVault Inc.	T-CHSUBS2-07F-ZC9560	Suburban Std 2 Dwr	\$2,935.00	\$2,513.60
336320	TruckVault Inc.	T-CHSUBS2-07M	Chevrolet Suburban Std 2 Dwr, dimensions: 52L x 48W	\$2,755.00	\$2,359.45
336320	TruckVault Inc.	T-CHSUBS2-07M-BS	Chevrolet Suburban Std 2 Dwr, dimensions: 52L x 48W	\$2,755.00	\$2,359.45
336320	TruckVault Inc.	T-CHSUBS2-07M-PT	Chevrolet Suburban Std 2 Dwr, dimensions: 52L x 48W	\$3,465.00	\$2,967.51
336320	TruckVault Inc.	T-CHSUBS2-07S	Chevrolet Suburban Std 2 Dwr, dimensions: 28L x 48W	\$2,445.00	\$2,093.95
336320	TruckVault Inc.	T-CHSUBS2-07S-BS	Chevrolet Suburban Std 2 Dwr, dimensions: 28L x 48W	\$2,445.00	\$2,093.95
336320	TruckVault Inc.	T-CHSUBS2-07S-PT	Chevrolet Suburban Std 2 Dwr, dimensions: 28L x 48W	\$3,140.00	\$2,689.17
336320	TruckVault Inc.	T-CHSUBS2-12F	Chevrolet Suburban Std 2 Dwr, dimensions: 60L x 48W	\$2,985.00	\$2,556.42
336320	TruckVault Inc.	T-CHSUBS2-12F-HT	Suburban Std 2 Dwr	\$3,540.00	\$3,031.74
336320	TruckVault Inc.	T-CHSUBS2-12F-PP	Chevrolet Suburban Std 2 Dwr, dimensions: 57L x 48W	\$2,845.00	\$2,436.52
336320	TruckVault Inc.	T-CHSUBS2-12F-PT	Chevrolet Suburban Std 2 Dwr, dimensions: 60L x 48W	\$3,685.00	\$3,155.92
336320	TruckVault Inc.	T-CHSUBS2-12M	Chevrolet Suburban Std 2 Dwr, dimensions: 52L x 48W	\$2,755.00	\$2,359.45
336320	TruckVault Inc.	T-CHSUBS2-12S	Chevrolet Suburban Std 2 Dwr, dimensions: 28L x 48W	\$2,445.00	\$2,093.95
336320	TruckVault Inc.	T-CHSUBS2-15F	Chevrolet Suburban Std 2 Dwr, dimensions: 60L x 48W	\$2,845.00	\$2,436.52
336320	TruckVault Inc.	T-CHSUBS2-15F-CR	Chevrolet Suburban Std 2 Dwr, dimensions: 58L x 48W	\$3,195.00	\$2,736.27
336320	TruckVault Inc.	T-CHSUBS2-15F-HT	Suburban Std 2 Dwr	\$3,540.00	\$3,031.74
336320	TruckVault Inc.	T-CHSUBS2-15F-PP	Chevrolet Suburban Std 2 Dwr, dimensions: 57L x 48W	\$2,845.00	\$2,436.52
336320	TruckVault Inc.	T-CHSUBS2-15F-PT	Suburban Std 2 Dwr	\$3,540.00	\$3,031.74
336320	TruckVault Inc.	T-CHSUBS2-15M	Chevrolet Suburban Std 2 Dwr, dimensions: 52L x 48W	\$2,755.00	\$2,359.45
336320	TruckVault Inc.	T-CHSUBS2-15M-CR	Chevrolet Suburban Std 2 Dwr, dimensions: 52L x 48W	\$3,145.00	\$2,693.45
336320	TruckVault Inc.	T-CHSUBS2-15M-HT	Suburban Std 2 Dwr	\$3,540.00	\$3,031.74
336320	TruckVault Inc.	T-CHSUBS2-15M-PT	Suburban Std 2 Dwr	\$3,465.00	\$2,967.51
336320	TruckVault Inc.	T-CHSUBS2-15S	Chevrolet Suburban Std 2 Dwr, dimensions: 29L x 48W	\$2,445.00	\$2,093.95
336320	TruckVault Inc.	T-CHSUBS2-15S-PT	Suburban Std 2 DwrS-Size, Tray Removed	\$3,140.00	\$2,689.17
336320	TruckVault Inc.	T-CHSUBS2-21F-TF	Suburban Std 2 Dwr	\$2,845.00	\$2,436.52
336320	TruckVault Inc.	T-CHSUBS2-88F	Chevrolet Suburban Std 2 Dwr, dimensions: 62.5L x 48W	\$2,985.00	\$2,556.42
336320	TruckVault Inc.	T-CHSUBS2-88F-PT	Chevrolet Suburban Std 2 Dwr, dimensions: 62.5L x 47W	\$3,685.00	\$3,155.92
336320	TruckVault Inc.	T-CHSUBS2-88M	Chevrolet Suburban Std 2 Dwr, dimensions: 54L x 48W	\$2,845.00	\$2,436.52
336320	TruckVault Inc.	T-CHSUBS2-88M-PT	Chevrolet Suburban Std 2 Dwr, dimensions: 54L x 48W	\$3,540.00	\$3,031.74
336320	TruckVault Inc.	T-CHSUBS2-88S	Chevrolet Suburban Std 2 Dwr, dimensions: 32L x 48W	\$2,445.00	\$2,093.95
336320	TruckVault Inc.	T-CHSUBSO-00F	Chevrolet Suburban Std OS Dwr, dimensions: 62.5L x 48W	\$2,985.00	\$2,556.42
336320	TruckVault Inc.	T-CHSUBSO-00F-LN	Chevrolet Suburban Std OS Dwr, dimensions: 62.5L x 48W	\$2,985.00	\$2,556.42
336320	TruckVault Inc.	T-CHSUBSO-00F-PT	Chevrolet Suburban Std OS Dwr, dimensions: 62.5L x 48W	\$3,685.00	\$3,155.92
336320	TruckVault Inc.	T-CHSUBSO-00M	Chevrolet Suburban Std OS Dwr, dimensions: 54L x 48W	\$2,845.00	\$2,436.52
336320	TruckVault Inc.	T-CHSUBSO-00M-LN	Chevrolet Suburban Std OS Dwr, dimensions: 54L x 48W	\$2,845.00	\$2,436.52
336320	TruckVault Inc.	T-CHSUBSO-00M-PT	Chevrolet Suburban Std OS Dwr, dimensions: 54L x 48W	\$3,540.00	\$3,031.74
336320	TruckVault Inc.	T-CHSUBSO-00S	Chevrolet Suburban Std OS Dwr, dimensions: 30L x 48W	\$2,445.00	\$2,093.95
336320	TruckVault Inc.	T-CHSUBSO-00S-PT	Chevrolet Suburban Std OS Dwr, dimensions: 29L x 48W	\$3,140.00	\$2,689.17
336320	TruckVault Inc.	T-CHSUBSO-07F	Chevrolet Suburban Std OS Dwr, dimensions: 60L x 48W	\$2,985.00	\$2,556.42
336320	TruckVault Inc.	T-CHSUBSO-07F-PT	Chevrolet Suburban Std OS Dwr, dimensions: 60L x 48W	\$3,685.00	\$3,155.92
336320	TruckVault Inc.	T-CHSUBSO-07M	Chevrolet Suburban Std OS Dwr, dimensions: 52L x 48W	\$2,755.00	\$2,359.45

336320	TruckVault Inc.	T-CHSUBSO-07M-PT	Chevrolet Suburban Std OS Dwr, dimensions: 52L x 48W	\$3,465.00	\$2,967.51
336320	TruckVault Inc.	T-CHSUBSO-07S	Chevrolet Suburban Std OS Dwr, dimensions: 28L x 48W	\$2,445.00	\$2,093.95
336320	TruckVault Inc.	T-CHSUBSO-07S-PT	Chevrolet Suburban Std Offset, dimensions: 28L x 48W	\$3,140.00	\$2,689.17
336320	TruckVault Inc.	T-CHSUBSO-12F	Chevrolet Suburban Std OS Dwr, dimensions: 60L x 48W	\$2,985.00	\$2,556.42
336320	TruckVault Inc.	T-CHSUBSO-12F-PP	Chevrolet Suburban Std OS Dwr, dimensions: 60L x 48W	\$2,985.00	\$2,556.42
336320	TruckVault Inc.	T-CHSUBSO-12F-PT	Chevrolet Suburban Std OS Dwr, dimensions: 60L x 48W	\$3,685.00	\$3,155.92
336320	TruckVault Inc.	T-CHSUBSO-12M	Chevrolet Suburban Std OS Dwr, dimensions: 52L x 48W	\$2,755.00	\$2,359.45
336320	TruckVault Inc.	T-CHSUBSO-12S	Chevrolet Suburban Std OS Dwr, dimensions: 28L x 48W	\$2,445.00	\$2,093.95
336320	TruckVault Inc.	T-CHSUBSO-15F	Chevrolet Suburban Std Offset Dwr, dimensions: 60L x 48W	\$2,985.00	\$2,556.42
336320	TruckVault Inc.	T-CHSUBSO-15F-CR	Chevrolet Suburban Std Offset Dwr, dimensions: 58L x 48W	\$3,195.00	\$2,736.27
336320	TruckVault Inc.	T-CHSUBSO-15F-PP	Chevrolet Suburban Std OS Dwr, dimensions: 57L x 48W	\$2,845.00	\$2,436.52
336320	TruckVault Inc.	T-CHSUBSO-15M	Chevrolet Suburban Std OS Dwr, dimensions: 52L x 48W	\$2,755.00	\$2,359.45
336320	TruckVault Inc.	T-CHSUBSO-15M-CR	Chevrolet Suburban Std OS Dwr, dimensions: 52L x 48W	\$3,145.00	\$2,693.45
336320	TruckVault Inc.	T-CHSUBSO-15S	Chevrolet Suburban Std OS Dwr, dimensions: 29L x 48W	\$2,445.00	\$2,093.95
336320	TruckVault Inc.	T-CHSUBSO-15S-HT-ZC9288	Suburban Std OS Dwr	\$3,155.00	\$2,702.02
336320	TruckVault Inc.	T-CHSUBSO-15S-PT	Suburban Std OS Dwr	\$3,140.00	\$2,689.17
336320	TruckVault Inc.	T-CHSUBSO-88F	Chevrolet Suburban Std OS Dwr, dimensions: 62.5L x 48W	\$2,985.00	\$2,556.42
336320	TruckVault Inc.	T-CHSUBSO-88M	Chevrolet Suburban Std OS Dwr, dimensions: 54L x 48W	\$2,845.00	\$2,436.52
336320	TruckVault Inc.	T-CHSUBSO-88S	Chevrolet Suburban Std OS Dwr, dimensions: 32L x 48W	\$2,445.00	\$2,093.95
336320	TruckVault Inc.	T-CHSUBU1-00S	Suburban Utility 1 Dwr	\$1,995.00	\$1,708.56
336320	TruckVault Inc.	T-CHSUBU1-07S	Suburban Utility 1 Dwr	\$1,995.00	\$1,708.56
336320	TruckVault Inc.	T-CHSUBU1-15N-ZC8857	Suburban Utility 1 Dwr	\$2,125.00	\$1,819.90
336320	TruckVault Inc.	T-CHSUBU1-15S	Suburban Utility 1 Dwr	\$1,995.00	\$1,708.56
336320	TruckVault Inc.	T-CHSUBU1-15S-HT	Suburban Utility 1 Dwr	\$2,690.00	\$2,303.78
336320	TruckVault Inc.	T-CHSUBU1-21S	Suburban Utility 1 DwrS-Size, 3rd Seat Upright	\$1,995.00	\$1,708.56
336320	TruckVault Inc.	T-CHSUBU2-00F	Suburban Utility 2 Dwr	\$3,095.00	\$2,650.63
336320	TruckVault Inc.	T-CHSUBU2-07F	Suburban Utility 2 Dwr	\$3,095.00	\$2,650.63
336320	TruckVault Inc.	T-CHSUBU2-07S	Suburban Utility 2 Dwr	\$2,525.00	\$2,162.47
336320	TruckVault Inc.	T-CHSUBU2-12F-HT	Suburban Utility 2 Dwr	\$3,640.00	\$3,117.38
336320	TruckVault Inc.	T-CHSUBU2-15F	Suburban Utility 2 Dwr	\$2,945.00	\$2,522.17
336320	TruckVault Inc.	T-CHSUBU2-15F-TT-ZC8762	Suburban Utility 2 Dwr	\$4,005.00	\$3,429.97
336320	TruckVault Inc.	T-CHSUBU2-15M	Suburban Utility 2 Dwr	\$2,875.00	\$2,462.22
336320	TruckVault Inc.	T-CHSUBU2-15M-CR	Suburban Utility 2 Dwr	\$3,295.00	\$2,821.91
336320	TruckVault Inc.	T-CHSUBU2-15M-HT	Suburban Utility 2 Dwr	\$3,640.00	\$3,117.38
336320	TruckVault Inc.	T-CHSUBU2-15S	Suburban Utility 2 Dwr	\$2,545.00	\$2,179.60
336320	TruckVault Inc.	T-CHSUBU2-21F-TF	Suburban Utility 2 Dwr	\$2,825.00	\$2,419.40
336320	TruckVault Inc.	T-CHSUBU2-21F-TF-HT	Suburban Utility 2 DwrF-Size, HD Table, 3rd Seat Folded	\$3,640.00	\$3,117.38
336320	TruckVault Inc.	T-CHSUBU2-21F-TR-HT	Suburban Utility 2 DwrF-Size, HD Table, 3rd Seat Removed	\$3,640.00	\$3,117.38
336320	TruckVault Inc.	T-CHSUBU2-21M-TF	Suburban Utility 2 Dwr	\$2,625.00	\$2,248.11
336320	TruckVault Inc.	T-CHSUBU2-21S-HT	Suburban Utility 2 Dwr, HD TableS-Size, 3rd Seat Upright	\$3,240.00	\$2,774.81
336320	TruckVault Inc.	T-CHSUBUO-00M	Suburban Utility OS Dwr	\$2,945.00	\$2,522.17
336320	TruckVault Inc.	T-CHSUBUO-07F	Suburban Utility 2 Dwr Offset	\$2,945.00	\$2,522.17
336320	TruckVault Inc.	T-CHSUBUO-07M	Suburban Utility OS Dwr	\$2,945.00	\$2,522.17
336320	TruckVault Inc.	T-CHSUBUO-12F-HT	Suburban Utility OS DwrF-Size, No Tray/3rd; Heavy Tbl	\$3,640.00	\$3,117.38
336320	TruckVault Inc.	T-CHSUBUO-15F-HT	Suburban Utility OS Dwr	\$3,640.00	\$3,117.38
336320	TruckVault Inc.	T-CHSUBUO-15M-CR	Suburban Utility Offset Dwr	\$3,295.00	\$2,821.91
336320	TruckVault Inc.	T-CHSUBUO-21N-ZC11409	Suburban Utility 2 Dwr Offset	\$2,625.00	\$2,248.11
336320	TruckVault Inc.	T-CHSUBUO-21S-HT	Suburban Utility 2 Dwr Offset HD TableS-Size, 3rd Seat Upright	\$3,240.00	\$2,774.81
336320	TruckVault Inc.	T-CHTAHL1-21S-ZC11548B	Tahoe Lid	\$1,195.00	\$1,023.43
336320	TruckVault Inc.	T-CHTAHM1-00N	Chevrolet Tahoe Mag 1 Dwr, dimensions: 43L x 48W	\$2,295.00	\$1,965.49
336320	TruckVault Inc.	T-CHTAHM1-00N-LN	Chevrolet Tahoe Mag 1 Dwr, dimensions: 43L x 48W	\$2,295.00	\$1,965.49
336320	TruckVault Inc.	T-CHTAHM1-00N-LN-PT	Chevrolet Tahoe Mag 1 Dwr, dimensions: 42L x 48W	\$2,990.00	\$2,560.71
336320	TruckVault Inc.	T-CHTAHM1-00N-PP	Chevrolet Tahoe Mag 1 Dwr, dimensions: 40L x 48W	\$2,295.00	\$1,965.49
336320	TruckVault Inc.	T-CHTAHM1-00N-PP-LN	Chevrolet Tahoe Mag 1 Dwr, dimensions: 40L x 48W	\$2,295.00	\$1,965.49
336320	TruckVault Inc.	T-CHTAHM1-00N-PT	Chevrolet Tahoe Mag 1 Dwr, dimensions: 42L x 48W	\$2,990.00	\$2,560.71
336320	TruckVault Inc.	T-CHTAHM1-07N	Chevrolet Tahoe Mag 1 Dwr, dimensions: 38L x 48W	\$2,295.00	\$1,965.49
336320	TruckVault Inc.	T-CHTAHM1-07N-BS	Chevrolet Tahoe Mag 1 Dwr, dimensions: 38L x 48W	\$2,295.00	\$1,965.49
336320	TruckVault Inc.	T-CHTAHM1-07N-HD-ZC11088	Tahoe Mag 1 DwrC11088	\$1,695.00	\$1,451.64
336320	TruckVault Inc.	T-CHTAHM1-07N-PP	Chevrolet Tahoe Mag 1 Dwr, dimensions: 35L x 48W	\$2,095.00	\$1,794.21
336320	TruckVault Inc.	T-CHTAHM1-07N-PP-PT	Chevrolet Tahoe Mag 1 Dwr, dimensions: 34L x 48W	\$2,790.00	\$2,389.42
336320	TruckVault Inc.	T-CHTAHM1-07N-PT	Chevrolet Tahoe Mag 1 Dwr, dimensions: 38L x 48W	\$2,990.00	\$2,560.71
336320	TruckVault Inc.	T-CHTAHM1-12N	Chevrolet Tahoe Mag 1 Dwr, dimensions: 38L x 48W	\$2,295.00	\$1,965.49
336320	TruckVault Inc.	T-CHTAHM1-12N-FOB	Tahoe Mag 1 Dwr	\$2,295.00	\$1,965.49
336320	TruckVault Inc.	T-CHTAHM1-12N-PP	Chevrolet Tahoe Mag 1 Dwr, dimensions: 35L x 48W	\$2,095.00	\$1,794.21
336320	TruckVault Inc.	T-CHTAHM1-12N-PP-PT	Chevrolet Tahoe Mag 1 Dwr, dimensions: 34L x 48W	\$2,790.00	\$2,389.42
336320	TruckVault Inc.	T-CHTAHM1-12N-PT	Chevrolet Tahoe Mag 1 Dwr, dimensions: 38L x 48W	\$2,990.00	\$2,560.71
336320	TruckVault Inc.	T-CHTAHM1-12N-TC	Tahoe Mag 1 Dwr	\$2,295.00	\$1,965.49
336320	TruckVault Inc.	T-CHTAHM1-15N	Chevrolet Tahoe Mag 1 Dwr, dimensions: 38L x 48W	\$2,295.00	\$1,965.49

336320	TruckVault Inc.	T-CHTAHM1-15N-C1-ZC10765A	Tahoe Mag 1 DwrC10765A	\$2,325.00	\$1,991.18
336320	TruckVault Inc.	T-CHTAHM1-15N-C1-ZC9959	Tahoe Mag 1 Dwr	\$2,185.00	\$1,871.28
336320	TruckVault Inc.	T-CHTAHM1-15N-CR	Chevrolet Tahoe Mag 1 Dwr, dimensions: 35L x 48W	\$2,445.00	\$2,093.95
336320	TruckVault Inc.	T-CHTAHM1-15N-FP	Tahoe Mag 1 Dwr	\$2,295.00	\$1,965.49
336320	TruckVault Inc.	T-CHTAHM1-15N-FP-HT	Tahoe Mag 1 Dwr w/HD Table	\$2,990.00	\$2,560.71
336320	TruckVault Inc.	T-CHTAHM1-15N-HG	Tahoe Mag 1 Dwr	\$1,965.00	\$1,682.87
336320	TruckVault Inc.	T-CHTAHM1-15N-HP	Tahoe Mag 1 Dwr	\$1,895.00	\$1,622.92
336320	TruckVault Inc.	T-CHTAHM1-15N-HT	Chevrolet Tahoe Mag 1 Dwr, dimensions: 37L x 48W	\$2,990.00	\$2,560.71
336320	TruckVault Inc.	T-CHTAHM1-15N-HT-TT-ZC10708	Tahoe Mag 1 DwrHeavy Duty Top Tray & Table; C10708	\$3,845.00	\$3,292.95
336320	TruckVault Inc.	T-CHTAHM1-15N-PP	Chevrolet Tahoe Mag 1 Dwr, dimensions: 35L x 48W	\$2,095.00	\$1,794.21
336320	TruckVault Inc.	T-CHTAHM1-15N-PP-HP	Tahoe Mag 1 Dwr	\$1,695.00	\$1,451.64
336320	TruckVault Inc.	T-CHTAHM1-15N-PP-HT	Chevrolet Tahoe Mag 1 Dwr, dimensions: 31L x 48W	\$2,790.00	\$2,389.92
336320	TruckVault Inc.	T-CHTAHM1-15N-PP-TT	Chevrolet Tahoe Mag 1 Dwr, dimensions: 0L x 0W	\$2,940.00	\$2,517.88
336320	TruckVault Inc.	T-CHTAHM1-15N-PP-ZC11692	Tahoe Mag 1 Dwr	\$2,095.00	\$1,794.21
336320	TruckVault Inc.	T-CHTAHM1-15N-PP-ZC8563	Tahoe Mag 1 Dwr	\$2,135.00	\$1,828.46
336320	TruckVault Inc.	T-CHTAHM1-15N-PT	Chevrolet Tahoe Mag 1 Dwr, dimensions: 38L x 48W	\$2,990.00	\$2,560.71
336320	TruckVault Inc.	T-CHTAHM1-15N-TT	Chevrolet Tahoe Mag 1 Dwr, dimensions: 0L x 0W	\$3,195.00	\$2,736.27
336320	TruckVault Inc.	T-CHTAHM1-15N-ZC10325	Tahoe Mag 1 Dwr CustomC10325 - Stacking on Existing	\$2,325.00	\$1,991.18
336320	TruckVault Inc.	T-CHTAHM1-15N-ZC11486	Tahoe Mag 1 Dwr	\$2,375.00	\$2,034.01
336320	TruckVault Inc.	T-CHTAHM1-15N-ZC9636	Tahoe Mag 1 Dwr w/Map Board Drawer	\$3,065.00	\$2,624.94
336320	TruckVault Inc.	T-CHTAHM1-15N-ZC9687	Tahoe CUST Mag 1 Dwr 1/2 width	\$1,915.00	\$1,640.05
336320	TruckVault Inc.	T-CHTAHM1-21N-TF	Tahoe Mag 1 Dwr3rd Folded	\$2,295.00	\$1,965.49
336320	TruckVault Inc.	T-CHTAHM1-21N-TF-HT	Tahoe Mag 1 Dwr3rd Folded, HD Table	\$2,990.00	\$2,560.71
336320	TruckVault Inc.	T-CHTAHM1-21N-TF-ZC11332	Tahoe Mag 1 Dwr3rd Folded	\$2,115.00	\$1,811.34
336320	TruckVault Inc.	T-CHTAHM1-21N-TR	Tahoe Mag 1 Dwr3rd Removed	\$2,295.00	\$1,965.49
336320	TruckVault Inc.	T-CHTAHM1-21N-TR-FP	Tahoe Mag 1 Dwr	\$2,295.00	\$1,965.49
336320	TruckVault Inc.	T-CHTAHM1-21N-TR-HP	Tahoe Mag 1 Dwr 1/2 width	\$1,895.00	\$1,622.92
336320	TruckVault Inc.	T-CHTAHM1-21N-TR-PP	Tahoe Mag 1 Dwr3rd Removed, Cage	\$2,295.00	\$1,965.49
336320	TruckVault Inc.	T-CHTAHM1-21N-TR-PP-HT	Tahoe Mag 1 Dwr	\$2,920.00	\$2,500.76
336320	TruckVault Inc.	T-CHTAHM1-21N-TR-PP-TT	Tahoe Mag 1 Dwr	\$2,940.00	\$2,517.88
336320	TruckVault Inc.	T-CHTAHM1-21N-TR-TT-ZC11620A	Tahoe Mag 1 Dwr	\$3,295.00	\$2,821.91
336320	TruckVault Inc.	T-CHTAHM1-21S	Tahoe Mag 1 Dwr	\$1,895.00	\$1,622.92
336320	TruckVault Inc.	T-CHTAHM1-92N	Chevrolet Tahoe Mag 1 Dwr, dimensions: 44L x 48W	\$2,295.00	\$1,965.49
336320	TruckVault Inc.	T-CHTAHM1-97N	Chevrolet Tahoe Mag 1 Dwr, dimensions: 44L x 48W	\$2,295.00	\$1,965.49
336320	TruckVault Inc.	T-CHTAHM2-00N	Chevrolet Tahoe Mag 2 Dwr, dimensions: 43L x 48W	\$2,845.00	\$2,436.52
336320	TruckVault Inc.	T-CHTAHM2-00N-LN	Chevrolet Tahoe Mag 2 Dwr, dimensions: 43L x 48W	\$2,845.00	\$2,436.52
336320	TruckVault Inc.	T-CHTAHM2-00N-LN-PT	Chevrolet Tahoe Mag 2 Dwr, dimensions: 42L x 48W	\$3,540.00	\$3,031.74
336320	TruckVault Inc.	T-CHTAHM2-00N-PN	Chevrolet Tahoe Mag 2 Dwr, dimensions: 42L x 48W	\$2,845.00	\$2,436.52
336320	TruckVault Inc.	T-CHTAHM2-00N-PP	Chevrolet Tahoe Mag 2 Dwr, dimensions: 40L x 48W	\$2,845.00	\$2,436.52
336320	TruckVault Inc.	T-CHTAHM2-00N-PP-LN	Chevrolet Tahoe Mag 2 Dwr, dimensions: 40L x 48W	\$2,845.00	\$2,436.52
336320	TruckVault Inc.	T-CHTAHM2-00N-PT	Chevrolet Tahoe Mag 2 Dwr, dimensions: 42L x 48W	\$3,540.00	\$3,031.74
336320	TruckVault Inc.	T-CHTAHM2-00N-TC-LN	Chevrolet Tahoe Mag 2 Dwr, dimensions: 40L x 48W	\$2,845.00	\$2,436.52
336320	TruckVault Inc.	T-CHTAHM2-07N	Chevrolet Tahoe Mag 2 Dwr, dimensions: 38L x 48W	\$2,845.00	\$2,436.52
336320	TruckVault Inc.	T-CHTAHM2-07N-BS	Chevrolet Tahoe Mag 2 Dwr, dimensions: 35L x 48W	\$2,645.00	\$2,265.24
336320	TruckVault Inc.	T-CHTAHM2-07N-PN	Chevrolet Tahoe Mag 2 Dwr, dimensions: 35L x 48W	\$2,645.00	\$2,265.24
336320	TruckVault Inc.	T-CHTAHM2-07N-PP	Chevrolet Tahoe Mag 2 Dwr, dimensions: 35L x 48W	\$2,645.00	\$2,265.24
336320	TruckVault Inc.	T-CHTAHM2-07N-PP-PT	Chevrolet Tahoe Mag 2 Dwr, dimensions: 34L x 48W	\$3,340.00	\$2,860.45
336320	TruckVault Inc.	T-CHTAHM2-07N-PT	Chevrolet Tahoe Mag 2 Dwr, dimensions: 37L x 48W	\$3,540.00	\$3,031.74
336320	TruckVault Inc.	T-CHTAHM2-07N-PT-PE-Z1	Tahoe Mag 2 Dwr	\$3,475.00	\$2,976.07
336320	TruckVault Inc.	T-CHTAHM2-12N	Chevrolet Tahoe Mag 2 Dwr, dimensions: 38L x 48W	\$2,845.00	\$2,436.52
336320	TruckVault Inc.	T-CHTAHM2-12N-HT	Chevrolet Tahoe Mag 2 Dwr, dimensions: 36L x 48W	\$3,540.00	\$3,031.74
336320	TruckVault Inc.	T-CHTAHM2-12N-PP	Chevrolet Tahoe Mag 2 Dwr, dimensions: 35L x 48W	\$2,645.00	\$2,265.24
336320	TruckVault Inc.	T-CHTAHM2-12N-PP-PT	Chevrolet Tahoe Mag 2 Dwr, dimensions: 34L x 48W	\$3,340.00	\$2,860.45
336320	TruckVault Inc.	T-CHTAHM2-12N-PT	Chevrolet Tahoe Mag 2 Dwr, dimensions: 38L x 48W	\$3,540.00	\$3,031.74
336320	TruckVault Inc.	T-CHTAHM2-15N	Chevrolet Tahoe Mag 2 Dwr, dimensions: 38L x 48W	\$2,845.00	\$2,436.52
336320	TruckVault Inc.	T-CHTAHM2-15N-CR	Chevrolet Tahoe Mag 2 Dwr, dimensions: 35L x 48W	\$2,995.00	\$2,564.99
336320	TruckVault Inc.	T-CHTAHM2-15N-HT	Chevrolet Tahoe Mag 2 Dwr, dimensions: 37L x 48W	\$3,540.00	\$3,031.74
336320	TruckVault Inc.	T-CHTAHM2-15N-PP	Chevrolet Tahoe Mag 2 Dwr, dimensions: 35L x 48W	\$2,645.00	\$2,265.24
336320	TruckVault Inc.	T-CHTAHM2-15N-PP-HT	Tahoe Mag 2 Dwr	\$3,340.00	\$2,860.45
336320	TruckVault Inc.	T-CHTAHM2-15N-PP-PT	Tahoe Mag 2 Dwr	\$3,340.00	\$2,860.45
336320	TruckVault Inc.	T-CHTAHM2-15N-PP-ZC8521	Tahoe Mag 2 Dwr	\$2,585.00	\$2,213.85
336320	TruckVault Inc.	T-CHTAHM2-15N-PT	Chevrolet Tahoe Mag 2 Dwr, dimensions: 35L x 48W	\$3,340.00	\$2,860.45
336320	TruckVault Inc.	T-CHTAHM2-15N-TT-ZC11259	Tahoe Mag 2 Dwr	\$3,585.00	\$3,070.28
336320	TruckVault Inc.	T-CHTAHM2-15N-ZC9359	Tahoe Mag 2 Dwr	\$3,155.00	\$2,702.02
336320	TruckVault Inc.	T-CHTAHM2-15N-ZC9460	Tahoe Custom	\$2,815.00	\$2,410.83
336320	TruckVault Inc.	T-CHTAHM2-15N-ZC9681	Tahoe Custom	\$2,815.00	\$2,410.83
336320	TruckVault Inc.	T-CHTAHM2-21N-TF	Tahoe Mag 2 Dwr3rd Folded	\$2,845.00	\$2,436.52
336320	TruckVault Inc.	T-CHTAHM2-21N-TR	Tahoe Mag 2 Dwr3rd Removed	\$2,845.00	\$2,436.52
336320	TruckVault Inc.	T-CHTAHM2-21N-TR-HT	Tahoe Mag 2 Dwr	\$3,420.00	\$2,928.97

336320	TruckVault Inc.	T-CHTAHM2-21N-TR-PP	Tahoe Mag 2 Dwr3rd Removed, Cage	\$2,845.00	\$2,436.52
336320	TruckVault Inc.	T-CHTAHM2-92N	Chevrolet Tahoe Mag 2 Dwr, dimensions: 44L x 48W	\$2,845.00	\$2,436.52
336320	TruckVault Inc.	T-CHTAHM2-92N-PP	Chevrolet Tahoe Mag 2 Dwr, dimensions: 44L x 48W	\$2,845.00	\$2,436.52
336320	TruckVault Inc.	T-CHTAHM2-97N	Chevrolet Tahoe Mag 2 Dwr, dimensions: 44L x 48W	\$2,845.00	\$2,436.52
336320	TruckVault Inc.	T-CHTAHM2-97N-PT	Chevrolet Tahoe Mag 2 Dwr, dimensions: 43L x 48W	\$3,540.00	\$3,031.74
336320	TruckVault Inc.	T-CHTAHMO-00N	Chevrolet Tahoe Mag OS Dwr, dimensions: 43L x 48W	\$2,845.00	\$2,436.52
336320	TruckVault Inc.	T-CHTAHMO-00N-LN	Chevrolet Tahoe Mag OS Dwr, dimensions: 43L x 48W	\$2,845.00	\$2,436.52
336320	TruckVault Inc.	T-CHTAHMO-00N-LN-PT	Chevrolet Tahoe Mag OS Dwr, dimensions: 42L x 48W	\$3,540.00	\$3,031.74
336320	TruckVault Inc.	T-CHTAHMO-00N-PP	Chevrolet Tahoe Mag OS Dwr, dimensions: 40L x 48W	\$2,845.00	\$2,436.52
336320	TruckVault Inc.	T-CHTAHMO-00N-PP-LN	Chevrolet Tahoe Mag OS Dwr, dimensions: 40L x 48W	\$2,845.00	\$2,436.52
336320	TruckVault Inc.	T-CHTAHMO-00N-PT	Chevrolet Tahoe Mag OS Dwr, dimensions: 42L x 48W	\$3,540.00	\$3,031.74
336320	TruckVault Inc.	T-CHTAHMO-00N-TC	Chevrolet Tahoe Mag OS Dwr, dimensions: 40L x 48W	\$2,845.00	\$2,436.52
336320	TruckVault Inc.	T-CHTAHMO-07N	Chevrolet Tahoe Mag OS Dwr, dimensions: 38L x 48W	\$2,845.00	\$2,436.52
336320	TruckVault Inc.	T-CHTAHMO-07N-PP	Chevrolet Tahoe Mag OS Dwr, dimensions: 35L x 48W	\$2,645.00	\$2,265.24
336320	TruckVault Inc.	T-CHTAHMO-07N-PT	Chevrolet Tahoe Mag OS Dwr, dimensions: 35L x 48W	\$3,340.00	\$2,860.45
336320	TruckVault Inc.	T-CHTAHMO-12N	Chevrolet Tahoe Mag OS Dwr, dimensions: 38L x 48W	\$2,845.00	\$2,436.52
336320	TruckVault Inc.	T-CHTAHMO-12N-HT	Chevrolet Tahoe Mag OS Dwr, dimensions: 35L x 48W	\$3,340.00	\$2,860.45
336320	TruckVault Inc.	T-CHTAHMO-12N-PP	Chevrolet Tahoe Mag OS Dwr, dimensions: 35L x 48W	\$2,645.00	\$2,265.24
336320	TruckVault Inc.	T-CHTAHMO-12N-PP-PT	Chevrolet Tahoe Mag OS Dwr, dimensions: 35L x 48W	\$3,340.00	\$2,860.45
336320	TruckVault Inc.	T-CHTAHMO-12N-PT	Chevrolet Tahoe Mag OS Dwr, dimensions: 38L x 48W	\$3,540.00	\$3,031.74
336320	TruckVault Inc.	T-CHTAHMO-15N	Chevrolet Tahoe Mag OS Dwr, dimensions: 38L x 48W	\$2,845.00	\$2,436.52
336320	TruckVault Inc.	T-CHTAHMO-15N-CR	Chevrolet Tahoe Mag OS Dwr, dimensions: 35L x 48W	\$2,995.00	\$2,564.99
336320	TruckVault Inc.	T-CHTAHMO-15N-HT	Chevrolet Tahoe Mag OS Dwr, dimensions: 37L x 48W	\$3,540.00	\$3,031.74
336320	TruckVault Inc.	T-CHTAHMO-15N-PP	Chevrolet Tahoe Mag OS Dwr, dimensions: 35L x 48W	\$2,645.00	\$2,265.24
336320	TruckVault Inc.	T-CHTAHMO-15N-PP-HT	Tahoe Mag OS Dwr	\$3,340.00	\$2,860.45
336320	TruckVault Inc.	T-CHTAHMO-15N-PP-PT	Tahoe Mag 2 Dwr Offset	\$3,340.00	\$2,860.45
336320	TruckVault Inc.	T-CHTAHMO-15N-PP-TT	Tahoe Mag OS Dwr	\$3,490.00	\$2,988.92
336320	TruckVault Inc.	T-CHTAHMO-15N-PP-ZC11484A	Tahoe Mag Offset Custom	\$2,525.00	\$2,162.47
336320	TruckVault Inc.	T-CHTAHMO-15N-PT	Chevrolet Tahoe Mag OS Dwr, dimensions: 38L x 48W	\$3,540.00	\$3,031.74
336320	TruckVault Inc.	T-CHTAHMO-15N-ZC10742A	Tahoe Mag Offset CustomC10742A	\$2,855.00	\$2,445.09
336320	TruckVault Inc.	T-CHTAHMO-21N-TF	Tahoe Mag 2 Dwr Offset3rd Folded	\$2,845.00	\$2,436.52
336320	TruckVault Inc.	T-CHTAHMO-21N-TR-PP	Tahoe Mag Offset Dwr	\$2,725.00	\$2,333.75
336320	TruckVault Inc.	T-CHTAHMO-92N	Chevrolet Tahoe Mag OS Dwr, dimensions: 44L x 48W	\$2,845.00	\$2,436.52
336320	TruckVault Inc.	T-CHTAHMO-94N-D2	Chevrolet Tahoe Mag OS Dwr, dimensions: 34L x 35W	\$2,795.00	\$2,393.70
336320	TruckVault Inc.	T-CHTAHMO-97N	Chevrolet Tahoe Mag OS Dwr, dimensions: 44L x 48W	\$2,845.00	\$2,436.52
336320	TruckVault Inc.	T-CHTAHMT-97N	Chevrolet Tahoe Mag T Dwr, dimensions: 44L x 53W	\$2,295.00	\$1,965.49
336320	TruckVault Inc.	T-CHTAHNO-15N-C2-HT-ZC8046	Tahoe CUST	\$2,655.00	\$2,273.80
336320	TruckVault Inc.	T-CHTAHNO-15N-C3-ZC10699A	Tahoe 0 Dwr 3 CubbiesTray/3rd Removed	\$1,405.00	\$1,203.27
336320	TruckVault Inc.	T-CHTAHN1-07N-ZC8806	Tahoe Custom	\$2,135.00	\$1,828.46
336320	TruckVault Inc.	T-CHTAHN1-15N-HT-C1-ZC11094A	Tahoe CustomC11094A	\$3,695.00	\$3,164.48
336320	TruckVault Inc.	T-CHTAHN1-15N-HT-C2-ZC10389	Tahoe CustomC10389	\$3,835.00	\$3,284.38
336320	TruckVault Inc.	T-CHTAHN1-15N-HT-ZC9572	Tahoe Custom 1 Dwr	\$4,115.00	\$3,524.18
336320	TruckVault Inc.	T-CHTAHN1-15N-TT-ZC10738A	Tahoe Custom 1 DwrC10738A	\$3,375.00	\$2,890.43
336320	TruckVault Inc.	T-CHTAHN1-15N-ZC10923	Tahoe Custom 1 Dwr	\$2,398.00	\$2,053.70
336320	TruckVault Inc.	T-CHTAHN1-15N-ZC10930	Tahoe Custom 1 DwrC10930	\$2,665.00	\$2,282.37
336320	TruckVault Inc.	T-CHTAHN1-15N-ZC8120	Tahoe CUST 1 Dwr	\$2,005.00	\$1,717.13
336320	TruckVault Inc.	T-CHTAHN1-15N-ZC8904	Tahoe Custom	\$2,135.00	\$1,828.46
336320	TruckVault Inc.	T-CHTAHN1-15N-ZC9312	Tahoe Custom 1 Dwr	\$2,485.00	\$2,128.21
336320	TruckVault Inc.	T-CHTAHN2-15N-HG-ZC10514	Tahoe Custom 2 Drawer	\$2,115.00	\$1,811.34
336320	TruckVault Inc.	T-CHTAHN2-15N-HT-ZC11337A	Tahoe Custom 2 DrawerC11337A	\$3,745.00	\$3,207.30
336320	TruckVault Inc.	T-CHTAHN2-15N-PP-HT-ZC11032	Tahoe Custom 2 Dwr stackedP-Cage, Tray/3rd Removed	\$3,695.00	\$3,164.48
336320	TruckVault Inc.	T-CHTAHN2-15N-ZC7999	Tahoe Custom	\$2,705.00	\$2,316.62
336320	TruckVault Inc.	T-CHTAHN2-15N-ZC9929	Tahoe Mag 2 Dwr	\$2,605.00	\$2,230.98
336320	TruckVault Inc.	T-CHTAHN2-15N-PP-ZC8389	Tahoe CUST OS Dwr	\$2,875.00	\$2,462.22
336320	TruckVault Inc.	T-CHTAHS1-00N	Chevrolet Tahoe Std 1 Dwr, dimensions: 45L x 48W	\$2,095.00	\$1,794.21
336320	TruckVault Inc.	T-CHTAHS1-00N-LN	Chevrolet Tahoe Std 1 Dwr, dimensions: 45L x 48W	\$2,095.00	\$1,794.21
336320	TruckVault Inc.	T-CHTAHS1-00N-LN-PT	Chevrolet Tahoe Std 1 Dwr, dimensions: 44L x 48W	\$2,790.00	\$2,389.42
336320	TruckVault Inc.	T-CHTAHS1-00N-PP	Chevrolet Tahoe Std 1 Dwr, dimensions: 42L x 48W	\$2,095.00	\$1,794.21
336320	TruckVault Inc.	T-CHTAHS1-00N-PP-LN	Chevrolet Tahoe Std 1 Dwr, dimensions: 42L x 48W	\$2,095.00	\$1,794.21
336320	TruckVault Inc.	T-CHTAHS1-00N-PT	Chevrolet Tahoe Std 1 Dwr, dimensions: 44L x 48W	\$2,790.00	\$2,389.42
336320	TruckVault Inc.	T-CHTAHS1-00N-TC	Chevrolet Tahoe Std 1 Dwr, dimensions: 42L x 48W	\$2,095.00	\$1,794.21
336320	TruckVault Inc.	T-CHTAHS1-07N	Chevrolet Tahoe Std 1 Dwr, dimensions: 39L x 48W	\$2,095.00	\$1,794.21
336320	TruckVault Inc.	T-CHTAHS1-07N-BS	Chevrolet Tahoe Std 1 Dwr, dimensions: 38L x 48W	\$2,095.00	\$1,794.21
336320	TruckVault Inc.	T-CHTAHS1-07N-PE-BS	Tahoe Std 1 Dwr	\$2,095.00	\$1,794.21
336320	TruckVault Inc.	T-CHTAHS1-07N-PP	Chevrolet Tahoe Std 1 Dwr, dimensions: 36L x 48W	\$2,095.00	\$1,794.21
336320	TruckVault Inc.	T-CHTAHS1-07N-PP-PE	Tahoe Std 1 Dwr	\$2,095.00	\$1,794.21
336320	TruckVault Inc.	T-CHTAHS1-07N-PT	Chevrolet Tahoe Std 1 Dwr, dimensions: 38L x 48W	\$2,790.00	\$2,389.42
336320	TruckVault Inc.	T-CHTAHS1-12N	Chevrolet Tahoe Std 1 Dwr, dimensions: 39L x 48W	\$2,095.00	\$1,794.21
336320	TruckVault Inc.	T-CHTAHS1-12N-HT	Chevrolet Tahoe Std 1 Dwr, dimensions: 38L x 48W	\$2,790.00	\$2,389.42

336320	TruckVault Inc.	T-CHTAHS1-12N-PP	Chevrolet Tahoe Std 1 Dwr, dimensions: 36L x 48W	\$2,095.00	\$1,794.21
336320	TruckVault Inc.	T-CHTAHS1-12N-PP-PT	Chevrolet Tahoe Std 1 Dwr, dimensions: 38L x 48W	\$2,790.00	\$2,389.42
336320	TruckVault Inc.	T-CHTAHS1-12N-PT	Chevrolet Tahoe Std 1 Dwr, dimensions: 38L x 48W	\$2,790.00	\$2,389.42
336320	TruckVault Inc.	T-CHTAHS1-12N-ZC10802	Tahoe Std 1 DwrC10802	\$1,695.00	\$1,451.64
336320	TruckVault Inc.	T-CHTAHS1-15N	Chevrolet Tahoe Std 1 Dwr, dimensions: 39L x 48W	\$2,095.00	\$1,794.21
336320	TruckVault Inc.	T-CHTAHS1-15N-CR	Chevrolet Tahoe Std 1 Dwr, dimensions: 37L x 48W	\$2,445.00	\$2,093.95
336320	TruckVault Inc.	T-CHTAHS1-15N-FP	Tahoe Std 1 Dwr	\$2,095.00	\$1,794.21
336320	TruckVault Inc.	T-CHTAHS1-15N-FP-HT	Tahoe Std 1 Dwr w/HD Table	\$2,790.00	\$2,389.42
336320	TruckVault Inc.	T-CHTAHS1-15N-HD-CR	Tahoe Std 1 Dwr 1/2 Width driver's side3rd Row Folded; Tray Removed	\$1,995.00	\$1,708.56
336320	TruckVault Inc.	T-CHTAHS1-15N-HG	Tahoe Elevated Std 1 Dwr	\$1,775.00	\$1,520.15
336320	TruckVault Inc.	T-CHTAHS1-15N-HP-CR	Tahoe Std 1 Dwr	\$2,165.00	\$1,854.16
336320	TruckVault Inc.	T-CHTAHS1-15N-HT	Chevrolet Tahoe Std 1 Dwr, dimensions: 37L x 48W	\$2,790.00	\$2,389.42
336320	TruckVault Inc.	T-CHTAHS1-15N-HT-ZC8112	Tahoe Std 1 Dwr	\$3,605.00	\$3,087.41
336320	TruckVault Inc.	T-CHTAHS1-15N-HT-ZC8656	Tahoe Std 1 Dwr	\$2,705.00	\$2,316.62
336320	TruckVault Inc.	T-CHTAHS1-15N-PP	Chevrolet Tahoe Std 1 Dwr, dimensions: 36L x 48W	\$2,095.00	\$1,794.21
336320	TruckVault Inc.	T-CHTAHS1-15N-PP-HG	Tahoe Std 1 Dwr Elevated Vault	\$1,775.00	\$1,520.15
336320	TruckVault Inc.	T-CHTAHS1-15N-PP-HT	Tahoe Std 1 Dwr	\$2,590.00	\$2,218.14
336320	TruckVault Inc.	T-CHTAHS1-15N-PP-PT	Chevrolet Tahoe Std 1 Dwr, dimensions: 35L x 48W	\$2,590.00	\$2,218.14
336320	TruckVault Inc.	T-CHTAHS1-15N-PP-TT	Chevrolet Tahoe Std 1 Dwr, dimensions: 36L x 48W	\$2,975.00	\$2,547.86
336320	TruckVault Inc.	T-CHTAHS1-15N-PP-ZC8659	Tahoe Cust Length Std 1 Dwr	\$1,915.00	\$1,640.05
336320	TruckVault Inc.	T-CHTAHS1-15N-PT	Chevrolet Tahoe Std 1 Dwr, dimensions: 39L x 48W	\$2,790.00	\$2,389.42
336320	TruckVault Inc.	T-CHTAHS1-15N-PT-CR	Tahoe Std 1 Dwr Pull Out Table3rd Row Folded; Tray Removed	\$3,140.00	\$2,689.17
336320	TruckVault Inc.	T-CHTAHS1-15N-TT	Tahoe Std 1 Dwr	\$2,975.00	\$2,547.86
336320	TruckVault Inc.	T-CHTAHS1-15N-ZC8795	Tahoe Custom	\$2,585.00	\$2,213.85
336320	TruckVault Inc.	T-CHTAHS1-21N-TF	Tahoe Std 1 Dwr3rd Folded	\$2,095.00	\$1,794.21
336320	TruckVault Inc.	T-CHTAHS1-21N-TF-HT	Tahoe Std 1 Dwr3rd Folded, HD Table	\$2,790.00	\$2,389.42
336320	TruckVault Inc.	T-CHTAHS1-21N-TR	Tahoe Std 1 Dwr3rd Removed	\$2,095.00	\$1,794.21
336320	TruckVault Inc.	T-CHTAHS1-21N-TR-PP	Tahoe Std 1 Dwr3rd Removed, Cage	\$2,095.00	\$1,794.21
336320	TruckVault Inc.	T-CHTAHS1-21S	Tahoe Std 1 Dwr3rd Seat Upright	\$1,695.00	\$1,451.64
336320	TruckVault Inc.	T-CHTAHS1-92N	Chevrolet Tahoe Std 1 Dwr, dimensions: 45.5L x 48W	\$2,095.00	\$1,794.21
336320	TruckVault Inc.	T-CHTAHS1-97N	Chevrolet Tahoe Std 1 Dwr, dimensions: 45.5L x 48W	\$2,095.00	\$1,794.21
336320	TruckVault Inc.	T-CHTAHS1-97N-PP	Chevrolet Tahoe Std 1 Dwr, dimensions: 42.5L x 48W	\$2,095.00	\$1,794.21
336320	TruckVault Inc.	T-CHTAHS2-00N	Chevrolet Tahoe Std 2 Dwr, dimensions: 45L x 48W	\$2,645.00	\$2,265.24
336320	TruckVault Inc.	T-CHTAHS2-00N-LN	Chevrolet Tahoe Std 2 Dwr, dimensions: 45L x 48W	\$2,645.00	\$2,265.24
336320	TruckVault Inc.	T-CHTAHS2-00N-PP	Chevrolet Tahoe Std 2 Dwr, dimensions: 42L x 48W	\$2,645.00	\$2,265.24
336320	TruckVault Inc.	T-CHTAHS2-00N-PP-LN	Chevrolet Tahoe Std 2 Dwr, dimensions: 42L x 48W	\$2,645.00	\$2,265.24
336320	TruckVault Inc.	T-CHTAHS2-00N-PT	Chevrolet Tahoe Std 2 Dwr, dimensions: 44L x 48W	\$3,340.00	\$2,860.45
336320	TruckVault Inc.	T-CHTAHS2-07N	Chevrolet Tahoe Std 2 Dwr, dimensions: 39L x 48W	\$2,645.00	\$2,265.24
336320	TruckVault Inc.	T-CHTAHS2-07N-BS	Chevrolet Tahoe Std 2 Dwr, dimensions: 39L x 48W	\$2,645.00	\$2,265.24
336320	TruckVault Inc.	T-CHTAHS2-07N-PE	Tahoe Std 2 Dwr	\$2,645.00	\$2,265.24
336320	TruckVault Inc.	T-CHTAHS2-07N-PE-PT	Tahoe Std 2 Dwr	\$3,140.00	\$2,689.17
336320	TruckVault Inc.	T-CHTAHS2-07N-PP	Chevrolet Tahoe Std 2 Dwr, dimensions: 36L x 48W	\$2,645.00	\$2,265.24
336320	TruckVault Inc.	T-CHTAHS2-07N-PP-PE	Tahoe Std 2 Dwr, P-cage	\$2,445.00	\$2,093.95
336320	TruckVault Inc.	T-CHTAHS2-07N-PT	Chevrolet Tahoe Std 2 Dwr, dimensions: 39L x 48W	\$3,340.00	\$2,860.45
336320	TruckVault Inc.	T-CHTAHS2-12N	Chevrolet Tahoe Std 2 Dwr, dimensions: 39L x 48W	\$2,645.00	\$2,265.24
336320	TruckVault Inc.	T-CHTAHS2-12N-HT	Chevrolet Tahoe Std 2 Dwr, dimensions: 38L x 48W	\$3,340.00	\$2,860.45
336320	TruckVault Inc.	T-CHTAHS2-12N-PP	Chevrolet Tahoe Std 2 Dwr, dimensions: 36L x 48W	\$2,645.00	\$2,265.24
336320	TruckVault Inc.	T-CHTAHS2-12N-PT	Chevrolet Tahoe Std 2 Dwr, dimensions: 39L x 48W	\$3,340.00	\$2,860.45
336320	TruckVault Inc.	T-CHTAHS2-15N	Chevrolet Tahoe Std 2 Dwr, dimensions: 39L x 48W	\$2,645.00	\$2,265.24
336320	TruckVault Inc.	T-CHTAHS2-15N-CR	Chevrolet Tahoe Std 2 Dwr, dimensions: 37L x 48W	\$2,995.00	\$2,564.99
336320	TruckVault Inc.	T-CHTAHS2-15N-FP	Tahoe Std 2 Dwr	\$2,645.00	\$2,265.24
336320	TruckVault Inc.	T-CHTAHS2-15N-HT	Tahoe Std 2 Dwr	\$3,340.00	\$2,860.45
336320	TruckVault Inc.	T-CHTAHS2-15N-PP	Chevrolet Tahoe Std 2 Dwr, dimensions: 36L x 48W	\$2,645.00	\$2,265.24
336320	TruckVault Inc.	T-CHTAHS2-15N-PP-HT	Tahoe Std 2 Dwr	\$3,140.00	\$2,689.17
336320	TruckVault Inc.	T-CHTAHS2-15N-PT	Chevrolet Tahoe Std 2 Dwr, dimensions: 38L x 48W	\$3,340.00	\$2,860.45
336320	TruckVault Inc.	T-CHTAHS2-15N-TT-ZC8531	Tahoe Std 2 Dwr	\$3,335.00	\$2,866.17
336320	TruckVault Inc.	T-CHTAHS2-15N-ZC9716	Tahoe Std 2 Dwr	\$2,135.00	\$1,828.46
336320	TruckVault Inc.	T-CHTAHS2-21N-TF	Tahoe Std 2 Dwr3rd Folded	\$2,645.00	\$2,265.24
336320	TruckVault Inc.	T-CHTAHS2-21N-TF-HT	Tahoe Std 2 Dwr	\$3,020.00	\$2,586.40
336320	TruckVault Inc.	T-CHTAHS2-21N-TR	Tahoe Std 2 Dwr3rd Removed	\$2,645.00	\$2,265.24
336320	TruckVault Inc.	T-CHTAHS2-21N-TR-HT	Tahoe Std 2 Dwr	\$3,020.00	\$2,586.40
336320	TruckVault Inc.	T-CHTAHS2-21N-TR-PP	Tahoe Std 2 Dwr3rd Removed, Cage	\$2,645.00	\$2,265.24
336320	TruckVault Inc.	T-CHTAHS2-92N	Chevrolet Tahoe Std 2 Dwr, dimensions: 45.5L x 48W	\$2,645.00	\$2,265.24
336320	TruckVault Inc.	T-CHTAHS2-92N-PT	Chevrolet Tahoe Std 2 Dwr, dimensions: 44.5L x 48W	\$3,340.00	\$2,860.45
336320	TruckVault Inc.	T-CHTAHS2-97N	Chevrolet Tahoe Std 2 Dwr, dimensions: 45.5L x 48W	\$2,645.00	\$2,265.24
336320	TruckVault Inc.	T-CHTAHS2-97N-HT	Tahoe Std 2 Dwr	\$3,340.00	\$2,860.45
336320	TruckVault Inc.	T-CHTAHSL-94N-D2-SI	Chevrolet Tahoe Std L Dwr, dimensions: 34L x 38.375W	\$2,215.00	\$1,896.98
336320	TruckVault Inc.	T-CHTAHSL-97N-D2-SI	Chevrolet Tahoe Std L Dwr, dimensions: 34L x 38.375W	\$2,215.00	\$1,896.98

336320	TruckVault Inc.	T-CHTAHSO-00N	Chevrolet Tahoe Std OS Dwr, dimensions: 45L x 48W	\$2,645.00	\$2,265.24
336320	TruckVault Inc.	T-CHTAHSO-00N-LN	Chevrolet Tahoe Std OS Dwr, dimensions: 45L x 48W	\$2,645.00	\$2,265.24
336320	TruckVault Inc.	T-CHTAHSO-00N-LN-PT	Chevrolet Tahoe Std OS Dwr, dimensions: 44L x 48W	\$3,340.00	\$2,860.45
336320	TruckVault Inc.	T-CHTAHSO-00N-PP	Chevrolet Tahoe Std OS Dwr, dimensions: 42L x 48W	\$2,645.00	\$2,265.24
336320	TruckVault Inc.	T-CHTAHSO-00N-PP-LN	Chevrolet Tahoe Std OS Dwr, dimensions: 42L x 48W	\$2,645.00	\$2,265.24
336320	TruckVault Inc.	T-CHTAHSO-00N-PT	Chevrolet Tahoe Std OS Dwr, dimensions: 44L x 48W	\$3,340.00	\$2,860.45
336320	TruckVault Inc.	T-CHTAHSO-00N-TC	Chevrolet Tahoe Std OS Dwr, dimensions: 42L x 48W	\$2,645.00	\$2,265.24
336320	TruckVault Inc.	T-CHTAHSO-07N	Chevrolet Tahoe Std OS Dwr, dimensions: 39L x 48W	\$2,645.00	\$2,265.24
336320	TruckVault Inc.	T-CHTAHSO-07N-PE	Tahoe Std OS Dwr	\$2,645.00	\$2,265.24
336320	TruckVault Inc.	T-CHTAHSO-07N-PP	Chevrolet Tahoe Std OS Dwr, dimensions: 36L x 48W	\$2,645.00	\$2,265.24
336320	TruckVault Inc.	T-CHTAHSO-07N-PP-PT	Chevrolet Tahoe Std OS Dwr, dimensions: 35L x 48W	\$3,140.00	\$2,689.17
336320	TruckVault Inc.	T-CHTAHSO-07N-PT	Chevrolet Tahoe Std OS Dwr, dimensions: 38L x 48W	\$3,340.00	\$2,860.45
336320	TruckVault Inc.	T-CHTAHSO-12N	Chevrolet Tahoe Std OS Dwr, dimensions: 39L x 48W	\$2,645.00	\$2,265.24
336320	TruckVault Inc.	T-CHTAHSO-12N-PP	Chevrolet Tahoe Std OS Dwr, dimensions: 36L x 48W	\$2,645.00	\$2,265.24
336320	TruckVault Inc.	T-CHTAHSO-12N-PP-PT	Chevrolet Tahoe Std OS Dwr, dimensions: 35L x 48W	\$3,140.00	\$2,689.17
336320	TruckVault Inc.	T-CHTAHSO-12N-PT	Chevrolet Tahoe Std OS Dwr, dimensions: 38L x 48W	\$3,340.00	\$2,860.45
336320	TruckVault Inc.	T-CHTAHSO-15N	Chevrolet Tahoe Std OS Dwr, dimensions: 39L x 48W	\$2,645.00	\$2,265.24
336320	TruckVault Inc.	T-CHTAHSO-15N-CR	Chevrolet Tahoe Std OS Dwr, dimensions: 35L x 48W	\$2,795.00	\$2,393.70
336320	TruckVault Inc.	T-CHTAHSO-15N-FP	Tahoe Std OS Dwr	\$2,645.00	\$2,265.24
336320	TruckVault Inc.	T-CHTAHSO-15N-HT	Tahoe Std Offset DwrHeavy Duty Table Extention	\$3,340.00	\$2,860.45
336320	TruckVault Inc.	T-CHTAHSO-15N-PP	Chevrolet Tahoe Std OS Dwr, dimensions: 36L x 48W	\$2,645.00	\$2,265.24
336320	TruckVault Inc.	T-CHTAHSO-15N-PP-HG	Tahoe Elevated Std OS Dwr	\$2,185.00	\$1,871.28
336320	TruckVault Inc.	T-CHTAHSO-15N-PT	Chevrolet Tahoe Std OS Dwr, dimensions: 38L x 48W	\$3,340.00	\$2,860.45
336320	TruckVault Inc.	T-CHTAHSO-21N-TF-HT	Tahoe Std 2 Dwr Offset	\$3,020.00	\$2,586.40
336320	TruckVault Inc.	T-CHTAHSO-21N-TR	Tahoe Std 2 Dwr Offset	\$2,645.00	\$2,265.24
336320	TruckVault Inc.	T-CHTAHSO-92N	Chevrolet Tahoe Std OS Dwr, dimensions: 45.5L x 48W	\$2,645.00	\$2,265.24
336320	TruckVault Inc.	T-CHTAHSO-97N	Chevrolet Tahoe Std OS Dwr, dimensions: 45.5L x 48W	\$2,645.00	\$2,265.24
336320	TruckVault Inc.	T-CHTAHST-92N	Chevrolet Tahoe Std T Dwr, dimensions: 45.5L x 48W	\$2,095.00	\$1,794.21
336320	TruckVault Inc.	T-CHTAHST-97N	Chevrolet Tahoe Std T Dwr, dimensions: 45.5L x 53W	\$2,095.00	\$1,794.21
336320	TruckVault Inc.	T-CHTAHU1-07N	Tahoe Utility 1 Dwr	\$2,195.00	\$1,879.85
336320	TruckVault Inc.	T-CHTAHU1-15N	Tahoe Utility 1 Dwr	\$2,195.00	\$1,879.85
336320	TruckVault Inc.	T-CHTAHU1-15N-CR	Tahoe Utility 1 Dwr	\$2,545.00	\$2,179.60
336320	TruckVault Inc.	T-CHTAHU1-15N-HP	Tahoe Utility 1 Dwr	\$1,795.00	\$1,537.28
336320	TruckVault Inc.	T-CHTAHU1-15N-HT	Tahoe Utility 1 Dwr	\$2,890.00	\$2,475.06
336320	TruckVault Inc.	T-CHTAHU1-15N-PP	Tahoe Utility 1 Dwr	\$1,995.00	\$1,708.56
336320	TruckVault Inc.	T-CHTAHU1-15N-PP-HT	Tahoe Utility 1 DwrP-Cage, No 3rd, Heavy Talbe	\$2,690.00	\$2,303.78
336320	TruckVault Inc.	T-CHTAHU1-15N-PP-ZC10997	Tahoe Utility 1 Dwr Tray/3rd RemovedNarrowed for Westin P-Cage,	\$2,225.00	\$1,905.54
336320	TruckVault Inc.	T-CHTAHU1-15N-ZC10101	Tahoe Utility 1 DwrTray/3rd Removed	\$2,225.00	\$1,905.54
336320	TruckVault Inc.	T-CHTAHU1-15N-ZC8411	Tahoe Utility 1 Dwr	\$2,025.00	\$1,734.26
336320	TruckVault Inc.	T-CHTAHU1-21N-TF	Tahoe Utility 1 Dwr3rd Folded	\$2,195.00	\$1,879.85
336320	TruckVault Inc.	T-CHTAHU1-21N-TF-HT	Tahoe Utility 1 Dwr3rd Folded, HD Table	\$2,890.00	\$2,475.06
336320	TruckVault Inc.	T-CHTAHU1-21N-TR	Tahoe Utility 1 Dwr3rd Removed	\$2,195.00	\$1,879.85
336320	TruckVault Inc.	T-CHTAHU1-21N-TR-PP	Tahoe Utility 1 Dwr3rd Removed, Cage	\$2,195.00	\$1,879.85
336320	TruckVault Inc.	T-CHTAHU2-00N	Tahoe Utility 2 Dwr	\$2,745.00	\$2,350.88
336320	TruckVault Inc.	T-CHTAHU2-15N	Tahoe Utility 2 Dwr	\$2,745.00	\$2,350.88
336320	TruckVault Inc.	T-CHTAHU2-15N-CR	Tahoe Utility 2 Dwr	\$3,095.00	\$2,650.63
336320	TruckVault Inc.	T-CHTAHU2-15N-HT	Tahoe Utility 2 DwrTray/3rd Removed; HD Table	\$3,440.00	\$2,946.10
336320	TruckVault Inc.	T-CHTAHU2-15N-PP	Tahoe Utility 2 Dwr	\$2,545.00	\$2,179.60
336320	TruckVault Inc.	T-CHTAHU2-15N-PP-HT	Tahoe Utility 2 Dwr	\$3,240.00	\$2,774.81
336320	TruckVault Inc.	T-CHTAHU2-21N-TF	Tahoe Utility 2 Dwr3rd Folded	\$2,745.00	\$2,350.88
336320	TruckVault Inc.	T-CHTAHU2-21N-TR	Tahoe Utility 2 Dwr3rd Removed	\$2,745.00	\$2,350.88
336320	TruckVault Inc.	T-CHTAHU2-21N-TR-PP	Tahoe Utility 2 Dwr3rd Removed, Cage	\$2,745.00	\$2,350.88
336320	TruckVault Inc.	T-CHTAHUO-07N	Tahoe Utility OS Dwr	\$2,745.00	\$2,350.88
336320	TruckVault Inc.	T-CHTAHUO-15N	Tahoe Utility OS Dwr	\$2,745.00	\$2,350.88
336320	TruckVault Inc.	T-CHTAHUO-15N-CR	Tahoe Utility OS Dwr	\$3,095.00	\$2,650.63
336320	TruckVault Inc.	T-CHTAHUO-15N-HT	Tahoe Utility OS Dwr	\$3,440.00	\$2,946.10
336320	TruckVault Inc.	T-CHTAHUO-15N-PP	Tahoe Utility OS Dwr	\$2,545.00	\$2,179.60
336320	TruckVault Inc.	T-CHTAHUO-15N-PP-HT	Tahoe Utility OS Dwr	\$3,240.00	\$2,774.81
336320	TruckVault Inc.	T-CHTAHUO-15N-ZC6768	Tahoe Utility 2 Dwr	\$2,295.00	\$1,965.49
336320	TruckVault Inc.	T-CHTAHUO-21N-TF	Tahoe Utility OS Dwr	\$2,745.00	\$2,350.88
336320	TruckVault Inc.	T-CHTAHUO-21N-TR	Tahoe Utility 2 Dwr Offset	\$2,745.00	\$2,350.88
336320	TruckVault Inc.	T-CHTBXM1-02N-TR	Chevrolet Trailblazer EXT Mag 1 Dwr, dimensions: 45L x 45W	\$2,295.00	\$1,965.49
336320	TruckVault Inc.	T-CHTBXM2-02N-TR	Chevrolet Trailblazer EXT Mag 2 Dwr, dimensions: 45L x 45W	\$2,845.00	\$2,436.52
336320	TruckVault Inc.	T-CHTBXM2-02N-TR-PT	Chevrolet Trailblazer EXT Mag 2 Dwr, dimensions: 44L x 45W	\$3,540.00	\$3,031.74
336320	TruckVault Inc.	T-CHTBXMO-02N-TR	Chevrolet Trailblazer EXT Mag OS Dwr, dimensions: 45L x 45W	\$2,845.00	\$2,436.52
336320	TruckVault Inc.	T-CHTBXS1-02N-TR	Chevrolet Trailblazer EXT Std 1 Dwr, dimensions: 47L x 45W	\$2,095.00	\$1,794.21
336320	TruckVault Inc.	T-CHTBXS2-02N-TR	Chevrolet Trailblazer EXT Std 2 Dwr, dimensions: 47L x 45W	\$2,645.00	\$2,265.24
336320	TruckVault Inc.	T-CHTLBM1-02N	Chevrolet Trailblazer Mag 1 Dwr, dimensions: 32.5L x 44.5W	\$2,095.00	\$1,794.21

336320	TruckVault Inc.	T-CHTLBM1-02N-PP	Chevrolet Trailblazer Mag 1 Dwr, dimensions: 29.5L x 44.5W	\$2,095.00	\$1,794.21
336320	TruckVault Inc.	T-CHTLBM1-02N-PT	Chevrolet Trailblazer Mag 1 Dwr, dimensions: 31.5L x 44.5W	\$2,790.00	\$2,389.42
336320	TruckVault Inc.	T-CHTLBM1-02N-TR	Chevrolet Trailblazer Mag 1 Dwr, dimensions: 45L x 45W	\$2,215.00	\$1,896.98
336320	TruckVault Inc.	T-CHTLBM1-20N	Trailblazer Mag 1 DwrNo 3rd Seat	\$1,895.00	\$1,622.92
336320	TruckVault Inc.	T-CHTLBM2-02N	Chevrolet Trailblazer Mag 2 Dwr, dimensions: 32.5L x 44.5W	\$2,645.00	\$2,265.24
336320	TruckVault Inc.	T-CHTLBM2-02N-PT	Chevrolet Trailblazer Mag 2 Dwr, dimensions: 31.5L x 44.5W	\$3,340.00	\$2,860.45
336320	TruckVault Inc.	T-CHTLBM2-20N	Trailblazer Mag 2 DwrNo 3rd Seat	\$2,445.00	\$2,093.95
336320	TruckVault Inc.	T-CHTLBMO-02N	Chevrolet Trailblazer Mag OS Dwr, dimensions: 32.5L x 44.5W	\$2,645.00	\$2,265.24
336320	TruckVault Inc.	T-CHTLBMO-02N-PT	Chevrolet Trailblazer Mag OS Dwr, dimensions: 31.5L x 44.5W	\$3,340.00	\$2,860.45
336320	TruckVault Inc.	T-CHTLBS1-02N	Chevrolet Trailblazer Std 1 Dwr, dimensions: 34L x 44.5W	\$1,895.00	\$1,622.92
336320	TruckVault Inc.	T-CHTLBS1-02N-PP	Chevrolet Trailblazer Std 1 Dwr, dimensions: 31L x 44.5W	\$1,895.00	\$1,622.92
336320	TruckVault Inc.	T-CHTLBS1-02N-PT	Trailblazer Std 1 Dwr	\$2,590.00	\$2,218.14
336320	TruckVault Inc.	T-CHTLBS1-20N	Trailblazer Standard 1 DwrNo 3rd Seat	\$1,695.00	\$1,451.64
336320	TruckVault Inc.	T-CHTLBS2-02N	Chevrolet Trailblazer Std 2 Dwr, dimensions: 34L x 44.5W	\$2,445.00	\$2,093.95
336320	TruckVault Inc.	T-CHTLBS2-02N-PP	Chevrolet Trailblazer Std 2 Dwr, dimensions: 31L x 44.5W	\$2,445.00	\$2,093.95
336320	TruckVault Inc.	T-CHTLBS2-02N-PT	Chevrolet Trailblazer Std 2 Dwr, dimensions: 34L x 44.5W	\$3,140.00	\$2,689.17
336320	TruckVault Inc.	T-CHTLBS2-20N	Trailblazer Standard 2 DwrNo 3rd Seat	\$2,245.00	\$1,922.67
336320	TruckVault Inc.	T-CHTLBSO-02N	Chevrolet Trailblazer Std OS Dwr, dimensions: 34L x 44.5W	\$2,445.00	\$2,093.95
336320	TruckVault Inc.	T-CHTLBU1-20N	Trailblazer Utility 1 DwrNo 3rd Seat	\$1,795.00	\$1,537.28
336320	TruckVault Inc.	T-CHTLBU2-20N	Trailblazer Utility 2 DwrNo 3rd Seat	\$2,345.00	\$2,008.31
336320	TruckVault Inc.	T-CHTRVM1-09N	Chevrolet Traverse Mag 1 Dwr, dimensions: 41L x 41W	\$2,295.00	\$1,965.49
336320	TruckVault Inc.	T-CHTRVM1-18N	Traverse Mag 1 Dwr	\$2,295.00	\$1,965.49
336320	TruckVault Inc.	T-CHTRVM1-18N-HT	Traverse Mag 1 Dwr	\$2,990.00	\$2,560.71
336320	TruckVault Inc.	T-CHTRVM1-18N-TR-HG	Traverse Mag 1 Dwr	\$2,245.00	\$1,922.67
336320	TruckVault Inc.	T-CHTRVM1-18N-TT	Traverse Mag 1 Dwr3rd Row Seat Folded; Top Tray Heavy Duty	\$3,195.00	\$2,736.27
336320	TruckVault Inc.	T-CHTRVM1-18N-ZC10962	Traverse Mag 1 DwrC10962	\$2,115.00	\$1,811.34
336320	TruckVault Inc.	T-CHTRVM1-18N-ZC9717	Traverse Mag 1 Dwr	\$2,135.00	\$1,828.46
336320	TruckVault Inc.	T-CHTRVM2-09N	Chevrolet Traverse Mag 2 Dwr, dimensions: 41L x 41W	\$2,845.00	\$2,436.52
336320	TruckVault Inc.	T-CHTRVM2-09N-HT	Traverse Mag 2 Dwr	\$3,540.00	\$3,031.74
336320	TruckVault Inc.	T-CHTRVM2-18N	Traverse Mag 2 Dwr	\$2,845.00	\$2,436.52
336320	TruckVault Inc.	T-CHTRVMO-09N	Chevrolet Traverse Mag Offset, dimensions: 41L x 41W	\$2,845.00	\$2,436.52
336320	TruckVault Inc.	T-CHTRVMO-18N	Traverse Mag Offset	\$2,845.00	\$2,436.52
336320	TruckVault Inc.	T-CHTRVMO-18N-TR-HG	Traverse Mag 2 Dwr offsetElevated Version; 3rd Row Seats Removed	\$2,645.00	\$2,265.24
336320	TruckVault Inc.	T-CHTRVS1-09N	Chevrolet Traverse Std 1 Dwr, dimensions: 41L x 41W	\$2,095.00	\$1,794.21
336320	TruckVault Inc.	T-CHTRVS1-18N	Traverse Std 1 Dwr	\$2,095.00	\$1,794.21
336320	TruckVault Inc.	T-CHTRVS1-18N-TR-HG	Traverse Std 1 Dwr	\$2,045.00	\$1,751.39
336320	TruckVault Inc.	T-CHTRVS2-09N	Chevrolet Traverse Std 2 Dwr, dimensions: 46L x 41W	\$2,645.00	\$2,265.24
336320	TruckVault Inc.	T-CHTRVS2-18N	Traverse Std 2 Dwr	\$2,645.00	\$2,265.24
336320	TruckVault Inc.	T-CHTRVSO-09N	Chevrolet Traverse Std Offset, dimensions: 46L x 41W	\$2,645.00	\$2,265.24
336320	TruckVault Inc.	T-CHTRVSO-09N-HT	Chevrolet Traverse Std Offset, dimensions: 40L x 41W	\$3,340.00	\$2,860.45
336320	TruckVault Inc.	T-CHTRVSO-18N	Traverse Std 2 OS Dwr	\$2,645.00	\$2,265.24
336320	TruckVault Inc.	T-CHTRVU1-09N	Traverse Utility 1 Dwr	\$2,195.00	\$1,879.85
336320	TruckVault Inc.	T-CHTRVU1-18N	Traverse Utility 1 Dwr	\$2,195.00	\$1,879.85
336320	TruckVault Inc.	T-CHTRVU1-18N-TR-HG	Traverse Utility 1 Dwr	\$2,145.00	\$1,837.03
336320	TruckVault Inc.	T-CHTRVU1-18S	Traverse Utility 1 Dwr	\$1,795.00	\$1,537.28
336320	TruckVault Inc.	T-CHTRVU2-18N	Traverse Utility 2 Dwr	\$2,745.00	\$2,350.88
336320	TruckVault Inc.	T-CHTRVUO-18N	Traverse Utility Offset	\$2,745.00	\$2,350.88
336320	TruckVault Inc.	T-CHTRXM1-14N	Trax Mag 1 Dwr	\$1,695.00	\$1,451.64
336320	TruckVault Inc.	T-CHTRXM2-14N	Trax Mag 2 Dwr	\$2,245.00	\$1,922.67
336320	TruckVault Inc.	T-CHTRXS1-14N	Trax Std 1 Dwr	\$1,495.00	\$1,280.35
336320	TruckVault Inc.	T-CHTRXS2-14N	Trax Std 2 Dwr	\$2,045.00	\$1,751.39
336320	TruckVault Inc.	T-CHUPLM1-05L	Chevrolet Uplander Mag 1 Dwr, dimensions: 49.5L x 48W	\$2,435.00	\$2,085.39
336320	TruckVault Inc.	T-CHUPLM1-05L-PT	Chevrolet Uplander Mag 1 Dwr, dimensions: 48L x 48W	\$3,135.00	\$2,684.89
336320	TruckVault Inc.	T-CHUPLM2-05L	Chevrolet Uplander Mag 2 Dwr, dimensions: 49.5L x 48W	\$2,985.00	\$2,556.42
336320	TruckVault Inc.	T-CHUPLM2-05L-PT	Chevrolet Uplander Mag 2 Dwr, dimensions: 48L x 48W	\$3,685.00	\$3,155.92
336320	TruckVault Inc.	T-CHUPLM2-05S	Chevrolet Uplander Mag 2 Dwr, dimensions: 35.5L x 48W	\$2,645.00	\$2,265.24
336320	TruckVault Inc.	T-CHUPLMO-05L	Chevrolet Uplander Mag OS Dwr, dimensions: 35.5L x 48W	\$2,985.00	\$2,556.42
336320	TruckVault Inc.	T-CHUPLS1-05L	Chevrolet Uplander Std 1 Dwr, dimensions: 50.5L x 48W	\$2,215.00	\$1,896.98
336320	TruckVault Inc.	T-CHUPLS2-05L	Chevrolet Uplander Std 2 Dwr, dimensions: 50.5L x 48W	\$2,755.00	\$2,359.45
336320	TruckVault Inc.	T-CHUPLS2-05S	Chevrolet Uplander Std 2 Dwr, dimensions: 50.5L x 48W	\$2,755.00	\$2,359.45
336320	TruckVault Inc.	T-CHVENM1-90L	Chevrolet Venture Mag 1 Dwr, dimensions: 47L x 47W	\$2,295.00	\$1,965.49
336320	TruckVault Inc.	T-CHVENM1-90S	Chevrolet Venture Mag 1 Dwr, dimensions: 43L x 47W	\$2,295.00	\$1,965.49
336320	TruckVault Inc.	T-CHVENM2-90L	Chevrolet Venture Mag 2 Dwr, dimensions: 47L x 47W	\$2,845.00	\$2,436.52
336320	TruckVault Inc.	T-CHVENM2-90S	Chevrolet Venture Mag 2 Dwr, dimensions: 43L x 47W	\$2,845.00	\$2,436.52
336320	TruckVault Inc.	T-CHVENS1-90L	Chevrolet Venture Std 1 Dwr, dimensions: 47L x 47W	\$2,095.00	\$1,794.21
336320	TruckVault Inc.	T-CHVENS1-90S	Chevrolet Venture Std 1 Dwr, dimensions: 43L x 47W	\$2,095.00	\$1,794.21
336320	TruckVault Inc.	T-CHVENS2-90L	Chevrolet Venture Std 2 Dwr, dimensions: 47L x 47W	\$2,645.00	\$2,265.24
336320	TruckVault Inc.	T-CHVENS2-90S	Chevrolet Venture Std 2 Dwr, dimensions: 43L x 47W	\$2,645.00	\$2,265.24

336320	TruckVault Inc.	T-CHVENS2-90S-PT	Chevrolet Venture Std 2 Dwr, dimensions: 43L x 47W	\$3,340.00	\$2,860.45
336320	TruckVault Inc.	T-CHVENS2-97S	Chevrolet Venture Std 2 Dwr, dimensions: 50L x 48W	\$2,755.00	\$2,359.45
336320	TruckVault Inc.	T-CHVOLS1-10N	Volt Std 1 Dwr	\$2,095.00	\$1,794.21
336320	TruckVault Inc.	T-CRASPM1-07N	Aspen Mag 1 Drawer	\$2,295.00	\$1,965.49
336320	TruckVault Inc.	T-CRASPM2-07N	Aspen Mag 2 Drawer	\$2,845.00	\$2,436.52
336320	TruckVault Inc.	T-CRASPM2-07N-PT	Aspen Mag 2 Drawer	\$3,540.00	\$3,031.74
336320	TruckVault Inc.	T-CRASPM1-07N	Aspen Std 1 Drawer	\$2,095.00	\$1,794.21
336320	TruckVault Inc.	T-CRCONN1-98N	Intrepid Patrolman	\$1,875.00	\$1,605.79
336320	TruckVault Inc.	T-CRPACL1-17N	Pacifica Floor Vault3rd Row Uprightor	\$1,545.00	\$1,323.17
336320	TruckVault Inc.	T-CRPACL1-17N-ZC11365	Pacifica Floor Vault	\$1,615.00	\$1,383.12
336320	TruckVault Inc.	T-CRPACM1-04N	Pacifica Mag 1 Dwr	\$2,095.00	\$1,794.21
336320	TruckVault Inc.	T-CRPACM1-04N-PT	Pacifica Mag 1 Dwr	\$2,790.00	\$2,389.42
336320	TruckVault Inc.	T-CRPACM1-17N	Pacifica Mag 1 Dwr	\$2,435.00	\$2,085.39
336320	TruckVault Inc.	T-CRPACM2-04N	Pacifica Mag 2 Dwr	\$2,645.00	\$2,265.24
336320	TruckVault Inc.	T-CRPACM2-17N	Pacifica Mag 2 Dwr	\$3,045.00	\$2,607.81
336320	TruckVault Inc.	T-CRPACMO-04N	Pacifica Mag OS Dwr	\$2,645.00	\$2,265.24
336320	TruckVault Inc.	T-CRPACMO-17N	Pacifica Mag OS Dwr	\$3,045.00	\$2,607.81
336320	TruckVault Inc.	T-CRPACN0-17N	Hinged Lid BoxStow and Go Area	\$1,595.00	\$1,365.99
336320	TruckVault Inc.	T-CRPACS1-04N	Pacifica Std 1 Dwr	\$1,895.00	\$1,622.92
336320	TruckVault Inc.	T-CRPACS1-17N	Pacifica Std 1 Dwr	\$2,295.00	\$1,965.49
336320	TruckVault Inc.	T-CRPACS1-17N-HD	Pacifica Std 1 Dwr	\$1,895.00	\$1,622.92
336320	TruckVault Inc.	T-CRPACS2-04N	Pacifica Std 2 Dwr	\$2,445.00	\$2,093.95
336320	TruckVault Inc.	T-CRPACS2-17N	Pacifica Std 2 Dwr	\$2,845.00	\$2,436.52
336320	TruckVault Inc.	T-CRPTCM1-01N	PT Cruiser Mag 1 Dwr	\$1,895.00	\$1,622.92
336320	TruckVault Inc.	T-CRPTCM2-01N	PT Cruiser Mag 2 Dwr	\$2,445.00	\$2,093.95
336320	TruckVault Inc.	T-CRT&CM1-05L	Town & Country Mag 1 Dwr	\$2,295.00	\$1,965.49
336320	TruckVault Inc.	T-CRT&CM1-08N	Town & Country Mag 1 Dwr	\$2,295.00	\$1,965.49
336320	TruckVault Inc.	T-CRT&CM1-83L	Town & Country Mag 1 Dwr	\$2,295.00	\$1,965.49
336320	TruckVault Inc.	T-CRT&CM1-83S	Town & Country Mag 1 Dwr	\$2,295.00	\$1,965.49
336320	TruckVault Inc.	T-CRT&CM2-83L	Town & Country Mag 2 Dwr	\$2,845.00	\$2,436.52
336320	TruckVault Inc.	T-CRT&CM2-83S	Town & Country Mag 2 Dwr	\$2,845.00	\$2,436.52
336320	TruckVault Inc.	T-CRT&CN0-08L-C0	Hinged Lid BoxStow and Go Area	\$1,395.00	\$1,194.71
336320	TruckVault Inc.	T-CRT&CS1-08N	Town & Country Std 1 Dwr	\$2,095.00	\$1,794.21
336320	TruckVault Inc.	T-CRT&CS1-83L	Town & Country Std 1 Dwr	\$2,095.00	\$1,794.21
336320	TruckVault Inc.	T-CRT&CS1-83S	Town & Country Std 1 Dwr	\$2,095.00	\$1,794.21
336320	TruckVault Inc.	T-CRT&CS1-99L	Town & Country Std 1 Dwr	\$2,095.00	\$1,794.21
336320	TruckVault Inc.	T-CRT&CS2-05L	Town & Country Std 2 Dwr	\$2,645.00	\$2,265.24
336320	TruckVault Inc.	T-CRT&CS2-08N	Town & Country Std 2 Dwr	\$2,645.00	\$2,265.24
336320	TruckVault Inc.	T-CRT&CS2-83L	Town & Country Std 2 Dwr	\$2,645.00	\$2,265.24
336320	TruckVault Inc.	T-CRT&CS2-83S	Town & Country Std 2 Dwr	\$2,645.00	\$2,265.24
336320	TruckVault Inc.	T-CRVOYM1-20N	Voyager Mag 1 Dwr	\$2,435.00	\$2,085.39
336320	TruckVault Inc.	T-CRVOYM1-20N-HD	Voyager Mag 1 Dwr3rd Row Folded; Half Width Drivers Side	\$2,095.00	\$1,794.21
336320	TruckVault Inc.	T-CRVOYM1-20S	Voyager Mag 1 Dwr3rd Row Upright	\$1,895.00	\$1,622.92
336320	TruckVault Inc.	T-CRVOYM1-20S-HT	Voyager Mag 1 Dwr3rd Row Upright HD Table	\$2,755.00	\$2,359.45
336320	TruckVault Inc.	T-CRVOYM2-20N	Voyager Mag 2 Dwr	\$3,045.00	\$2,607.81
336320	TruckVault Inc.	T-CRVOYM2-20N-HT	Voyager Mag 2 DwrHD Table	\$3,740.00	\$3,203.02
336320	TruckVault Inc.	T-CRVOYN0-20N	Hinged Lid BoxStow and Go Area	\$1,595.00	\$1,365.99
336320	TruckVault Inc.	T-DGCALS1-07N	Caliber Std 1 Drawer	\$1,695.00	\$1,451.64
336320	TruckVault Inc.	T-DGCVNM1-01S	Dodge Caravan Mag 1 Dwr, dimensions: 42L x 48W	\$2,295.00	\$1,965.49
336320	TruckVault Inc.	T-DGCVNM1-08S	Dodge Caravan Mag 1 Dwr, dimensions: 40L x 47W	\$2,295.00	\$1,965.49
336320	TruckVault Inc.	T-DGCVNM1-83S	Dodge Caravan Mag 1 Dwr, dimensions: 43L x 47W	\$2,295.00	\$1,965.49
336320	TruckVault Inc.	T-DGCVNM2-01S	Dodge Caravan Mag 2 Dwr, dimensions: 42L x 48W	\$2,845.00	\$2,436.52
336320	TruckVault Inc.	T-DGCVNM2-83S	Dodge Caravan Mag 2 Dwr, dimensions: 43L x 47W	\$2,845.00	\$2,436.52
336320	TruckVault Inc.	T-DGCVNMO-01S	Dodge Caravan Mag OS Dwr, dimensions: 42L x 48W	\$2,845.00	\$2,436.52
336320	TruckVault Inc.	T-DGCVNS1-01S	Dodge Caravan Std 1 Dwr, dimensions: 43L x 48W	\$2,095.00	\$1,794.21
336320	TruckVault Inc.	T-DGCVNS1-08S	Dodge Caravan Std 1 Dwr, dimensions: 43L x 48W	\$2,095.00	\$1,794.21
336320	TruckVault Inc.	T-DGCVNS1-83S	Dodge Caravan Std 1 Dwr, dimensions: 43L x 47W	\$2,095.00	\$1,794.21
336320	TruckVault Inc.	T-DGCVNS2-01S	Dodge Caravan Std 2 Dwr, dimensions: 43L x 48W	\$2,645.00	\$2,265.24
336320	TruckVault Inc.	T-DGCVNS2-83S	Dodge Caravan Std 2 Dwr, dimensions: 43L x 47W	\$2,645.00	\$2,265.24
336320	TruckVault Inc.	T-DGDAKM2-00S-D4-PW	Dodge Dakota Pickup Mag 2 Dwr, dimensions: 63.5L x 45.75W	\$4,245.00	\$3,635.52
336320	TruckVault Inc.	T-DGDAKM2-05S-PC	Dakota Pickup Mag 2 Dwr	\$3,345.00	\$2,864.74
336320	TruckVault Inc.	T-DGDAKM2-95S-PW	Dodge Dakota Pickup Mag 2 Dwr, dimensions: 76L x 44W	\$4,545.00	\$3,892.44
336320	TruckVault Inc.	T-DGDAKMO-00S-D4-PW	Dodge Dakota Pickup Mag OS Dwr, dimensions: 63.5L x 45.75W	\$4,245.00	\$3,635.52
336320	TruckVault Inc.	T-DGDAKMO-95S-PW	Dodge Dakota Pickup Mag OS Dwr, dimensions: 76L x 44W	\$4,545.00	\$3,892.44
336320	TruckVault Inc.	T-DGDAKS1-05S-HD	Dakota Pickup Std 1 DwrHalf Width; Drivers Side	\$2,215.00	\$1,896.98
336320	TruckVault Inc.	T-DGDAKS1-05S-HD-PW	Dakota Std 1 Dwr Half Width	\$2,745.00	\$2,350.88
336320	TruckVault Inc.	T-DGDAKS2-00S-D4-PW	Dodge Dakota Sport Pickup Std 2 Dwr, dimensions: 63.5L x 45.75W	\$4,045.00	\$3,464.23
336320	TruckVault Inc.	T-DGDAKS2-87L-PW	Dodge Dakota Pickup Std 2 Dwr, dimensions: 1L x 1W	\$4,645.00	\$3,978.09
336320	TruckVault Inc.	T-DGDAKS2-95S-PW	Dodge Dakota Pickup Std 2 Dwr, dimensions: 76L x 44W	\$4,345.00	\$3,721.16



336320	TruckVault Inc.	T-DGDAKSO-00S-D4-PW	Dodge Dakota Sport Pickup Std OS Dwr, dimensions: 63.5L x 45.75W	\$4,045.00	\$3,464.23
336320	TruckVault Inc.	T-DGDAKSO-05S-PC-PW	Dakota Pickup Std 2 Dwr	\$4,045.00	\$3,464.23
336320	TruckVault Inc.	T-DGDAKSO-95S-PW	Dodge Dakota Pickup Std OS Dwr, dimensions: 76L x 44W	\$4,345.00	\$3,721.16
336320	TruckVault Inc.	T-DGDAKU1-05S-HD	Dakota Pickup Utility 1 DwrHalf Width; Drivers Side	\$2,325.00	\$1,991.18
336320	TruckVault Inc.	T-DGDURL1-11N-TR-PP	Durango Floor Vault	\$1,495.00	\$1,280.35
336320	TruckVault Inc.	T-DGDURL2-11N-TR	Durango Floor Vault	\$1,795.00	\$1,537.28
336320	TruckVault Inc.	T-DGDURM1-04N	Dodge Durango Mag 1 Dwr, dimensions: 42L x 46.5W	\$2,295.00	\$1,965.49
336320	TruckVault Inc.	T-DGDURM1-04N-PP	Dodge Durango Mag 1 Dwr, dimensions: 39L x 46.5W	\$2,295.00	\$1,965.49
336320	TruckVault Inc.	T-DGDURM1-04N-PT	Dodge Durango Mag 1 Dwr, dimensions: 41L x 46.5W	\$2,990.00	\$2,560.71
336320	TruckVault Inc.	T-DGDURM1-04S	Dodge Durango Mag 1 Dwr, dimensions: 26L x 46.5W	\$2,095.00	\$1,794.21
336320	TruckVault Inc.	T-DGDURM1-07N	Dodge Durango Mag 1 Dwr, dimensions: 42L x 45W	\$2,295.00	\$1,965.49
336320	TruckVault Inc.	T-DGDURM1-07N-PP	Dodge Durango Mag 1 Dwr, dimensions: 39L x 45.5W	\$2,295.00	\$1,965.49
336320	TruckVault Inc.	T-DGDURM1-07N-PP-PT	Dodge Durango Mag 1 Dwr, dimensions: 39L x 45.5W	\$2,990.00	\$2,560.71
336320	TruckVault Inc.	T-DGDURM1-07N-PT	Dodge Durango Mag 1 Dwr, dimensions: 42L x 45.5W	\$2,990.00	\$2,560.71
336320	TruckVault Inc.	T-DGDURM1-11N	Dodge Durango Mag 1 Dwr, dimensions: 41L x 40W	\$2,295.00	\$1,965.49
336320	TruckVault Inc.	T-DGDURM1-11N-HD	Durango Mag 1 Dwr	\$1,895.00	\$1,622.92
336320	TruckVault Inc.	T-DGDURM1-11N-HT	Dodge Durango Mag 1 Dwr, dimensions: 38L x 40W	\$2,990.00	\$2,560.71
336320	TruckVault Inc.	T-DGDURM1-11N-PP	Dodge Durango Mag 1 Dwr, dimensions: 38L x 40W	\$2,295.00	\$1,965.49
336320	TruckVault Inc.	T-DGDURM1-11N-PP-TR	Dodge Durango Mag 1 Dwr, dimensions: 38L x 40W	\$2,295.00	\$1,965.49
336320	TruckVault Inc.	T-DGDURM1-11N-PP-TR-HP	Durango Mag 1 Dwr3rd Row Removed / SSV; 1/2 Passenger Side	\$1,895.00	\$1,622.92
336320	TruckVault Inc.	T-DGDURM1-11N-PP-TR-TT	Durango Mag 1 Dwr	\$3,195.00	\$2,736.27
336320	TruckVault Inc.	T-DGDURM1-11N-PS-HG	Durango Mag 1 Dwr	\$2,245.00	\$1,922.67
336320	TruckVault Inc.	T-DGDURM1-11N-TR	Dodge Durango Mag 1 Dwr, dimensions: 41L x 40W	\$2,295.00	\$1,965.49
336320	TruckVault Inc.	T-DGDURM1-11N-TR-HD	Durango Mag 1 Dwr	\$1,895.00	\$1,622.92
336320	TruckVault Inc.	T-DGDURM1-11N-TR-HG	Durango Mag 1 Dwr	\$2,245.00	\$1,922.67
336320	TruckVault Inc.	T-DGDURM1-11N-TR-HG-ZC11346	Durango Mag 1 Dwr ElevatedC11346; Integrated Lid	\$2,245.00	\$1,922.67
336320	TruckVault Inc.	T-DGDURM1-11N-TR-HT	Durango Mag 1 Dwr	\$2,990.00	\$2,560.71
336320	TruckVault Inc.	T-DGDURM1-11N-TR-ZC8921	Durango Mag 1 Dwr	\$1,915.00	\$1,640.05
336320	TruckVault Inc.	T-DGDURM1-11N-TT	Durango Mag 1 Dwr	\$3,195.00	\$2,736.27
336320	TruckVault Inc.	T-DGDURM1-11N-ZC10668	Durango Mag 1 Dwr36 x 36	\$2,115.00	\$1,811.34
336320	TruckVault Inc.	T-DGDURM1-11S	Durango Mag 1 Dwr	\$1,895.00	\$1,622.92
336320	TruckVault Inc.	T-DGDURM1-98M	Dodge Durango Mag 1 Dwr, dimensions: 41.5L x 43.75W	\$2,295.00	\$1,965.49
336320	TruckVault Inc.	T-DGDURM1-98M-PT	Dodge Durango Mag 1 Dwr, dimensions: 40.5L x 43.75W	\$2,990.00	\$2,560.71
336320	TruckVault Inc.	T-DGDURM1-98S	Dodge Durango Mag 1 Dwr, dimensions: 26L x 43.75W	\$2,095.00	\$1,794.21
336320	TruckVault Inc.	T-DGDURM2-04N	Dodge Durango Mag 2 Dwr, dimensions: 42L x 46.5W	\$2,845.00	\$2,436.52
336320	TruckVault Inc.	T-DGDURM2-04N-PP	Dodge Durango Mag 2 Dwr, dimensions: 39L x 46.5W	\$2,845.00	\$2,436.52
336320	TruckVault Inc.	T-DGDURM2-04N-PT	Dodge Durango Mag 2 Dwr, dimensions: 41L x 46.5W	\$3,540.00	\$3,031.74
336320	TruckVault Inc.	T-DGDURM2-07N	Dodge Durango Mag 2 Dwr, dimensions: 42L x 45.5W	\$2,845.00	\$2,436.52
336320	TruckVault Inc.	T-DGDURM2-07N-PP	Dodge Durango Mag 2 Dwr, dimensions: 39L x 45.5W	\$2,845.00	\$2,436.52
336320	TruckVault Inc.	T-DGDURM2-07N-PT	Dodge Durango Mag 2 Dwr, dimensions: 41L x 45.5W	\$3,540.00	\$3,031.74
336320	TruckVault Inc.	T-DGDURM2-11N	Dodge Durango Mag 2 Dwr, dimensions: 41L x 40W	\$2,845.00	\$2,436.52
336320	TruckVault Inc.	T-DGDURM2-11N-HT	Durango Mag 2 Dwr	\$3,540.00	\$3,031.74
336320	TruckVault Inc.	T-DGDURM2-11N-PP	Dodge Durango Mag 2 Dwr, dimensions: 38L x 40W	\$2,845.00	\$2,436.52
336320	TruckVault Inc.	T-DGDURM2-11N-PP-HT	Durango Mag 2 Dwr	\$3,540.00	\$3,031.74
336320	TruckVault Inc.	T-DGDURM2-11N-PP-TR	Dodge Durango Mag 2 Dwr, dimensions: 38L x 40W	\$2,845.00	\$2,436.52
336320	TruckVault Inc.	T-DGDURM2-11N-PP-TR-HT	Durango Mag 2 Dwr 3rd Removed	\$3,540.00	\$3,031.74
336320	TruckVault Inc.	T-DGDURM2-11N-PT	Dodge Durango Mag 2 Dwr, dimensions: 40L x 40W	\$3,540.00	\$3,031.74
336320	TruckVault Inc.	T-DGDURM2-11N-TR	Dodge Durango Mag 2 Dwr, dimensions: 41L x 40W	\$2,845.00	\$2,436.52
336320	TruckVault Inc.	T-DGDURM2-11N-TR-HT	Durango Mag 2 Dwr	\$3,540.00	\$3,031.74
336320	TruckVault Inc.	T-DGDURM2-11N-TR-TT	Durango Mag 2 Dwr	\$3,745.00	\$3,207.30
336320	TruckVault Inc.	T-DGDURM2-98M	Dodge Durango Mag 2 Dwr, dimensions: 41.5L x 43.75W	\$2,845.00	\$2,436.52
336320	TruckVault Inc.	T-DGDURM2-98S	Dodge Durango Mag 2 Dwr, dimensions: 26L x 43.75W	\$2,645.00	\$2,265.24
336320	TruckVault Inc.	T-DGDURMO-04N	Dodge Durango Mag OS Dwr, dimensions: 42L x 46.5W	\$2,845.00	\$2,436.52
336320	TruckVault Inc.	T-DGDURMO-04N-PP	Dodge Durango Mag OS Dwr, dimensions: 39L x 46.5W	\$2,845.00	\$2,436.52
336320	TruckVault Inc.	T-DGDURMO-07N	Dodge Durango Mag OS Dwr, dimensions: 42L x 45.5W	\$2,845.00	\$2,436.52
336320	TruckVault Inc.	T-DGDURMO-07N-PP	Dodge Durango Mag OS Dwr, dimensions: 39L x 45.5W	\$2,845.00	\$2,436.52
336320	TruckVault Inc.	T-DGDURMO-07N-PT	Dodge Durango Mag OS Dwr, dimensions: 42L x 45.5W	\$3,540.00	\$3,031.74
336320	TruckVault Inc.	T-DGDURMO-11N	Dodge Durango Mag OS Dwr, dimensions: 41L x 40W	\$2,845.00	\$2,436.52
336320	TruckVault Inc.	T-DGDURMO-11N-HT	Durango Mag OS Dwr	\$3,540.00	\$3,031.74
336320	TruckVault Inc.	T-DGDURMO-11N-HT-TR	Durango Mag OS Dwr	\$3,540.00	\$3,031.74
336320	TruckVault Inc.	T-DGDURMO-11N-PP	Dodge Durango Mag OS Dwr, dimensions: 38L x 40W	\$2,845.00	\$2,436.52
336320	TruckVault Inc.	T-DGDURMO-11N-PS-HG	Durango Mag Offset DwrElevated Version; PPV; No 3rd Row Seats	\$2,645.00	\$2,265.24
336320	TruckVault Inc.	T-DGDURMO-11N-TR	Durango Mag OS Dwr	\$2,845.00	\$2,436.52
336320	TruckVault Inc.	T-DGDURMO-11N-TR-PP	Durango Mag O/S Dwr	\$2,985.00	\$2,556.42
336320	TruckVault Inc.	T-DGDURMO-11N-TR-PT	Durango Mag OS Dwr	\$3,540.00	\$3,031.74

336320	TruckVault Inc.	T-DGDURN0-11N-TR-C4-ZC8423	Durango CUST	\$2,585.00	\$2,213.85
336320	TruckVault Inc.	T-DGDURN1-11N-PS-HG	Durango 1 Dwr	\$2,145.00	\$1,837.03
336320	TruckVault Inc.	T-DGDURN1-11N-TR-HG	Durango 1 Dwr	\$2,145.00	\$1,837.03
336320	TruckVault Inc.	T-DGDURN1-11N-TR-HG-TT-ZC10208	Durango Custom Elevated	\$2,085.00	\$1,785.64
336320	TruckVault Inc.	T-DGDURN1-11N-TR-ZC9042	Durango Custom 1 Drawer	\$2,085.00	\$1,785.64
336320	TruckVault Inc.	T-DGDURN1-11N-TR-ZC9044	Durango Custom 1 Drawer	\$2,255.00	\$1,931.23
336320	TruckVault Inc.	T-DGDURS1-04N	Dodge Durango Std 1 Dwr, dimensions: 42L x 47.5W	\$2,095.00	\$1,794.21
336320	TruckVault Inc.	T-DGDURS1-04S	Dodge Durango Std 1 Dwr, dimensions: 26L x 48W	\$1,895.00	\$1,622.92
336320	TruckVault Inc.	T-DGDURS1-07N	Dodge Durango Std 1 Dwr, dimensions: 43L x 47.5W	\$2,095.00	\$1,794.21
336320	TruckVault Inc.	T-DGDURS1-07N-PP	Dodge Durango Std 1 Dwr, dimensions: 40L x 47.5W	\$2,095.00	\$1,794.21
336320	TruckVault Inc.	T-DGDURS1-11N	Dodge Durango Std 1 Dwr, dimensions: 44L x 40W	\$2,095.00	\$1,794.21
336320	TruckVault Inc.	T-DGDURS1-11N-PP	Dodge Durango Std 1 Dwr, dimensions: 41L x 40W	\$2,095.00	\$1,794.21
336320	TruckVault Inc.	T-DGDURS1-11N-PP-TR	Dodge Durango Std 1 Dwr, dimensions: 41L x 40W	\$2,095.00	\$1,794.21
336320	TruckVault Inc.	T-DGDURS1-11N-PT	Durango Std 1 Dwr	\$2,790.00	\$2,389.42
336320	TruckVault Inc.	T-DGDURS1-11N-TR	Dodge Durango Std 1 Dwr, dimensions: 44L x 40W	\$2,095.00	\$1,794.21
336320	TruckVault Inc.	T-DGDURS1-11N-TR-HG	Durango Std 1 Dwr	\$2,045.00	\$1,751.39
336320	TruckVault Inc.	T-DGDURS1-11S	Durango Std 1 Dwr	\$1,695.00	\$1,451.64
336320	TruckVault Inc.	T-DGDURS1-98M	Dodge Durango Std 1 Dwr, dimensions: 43L x 43.75W	\$2,095.00	\$1,794.21
336320	TruckVault Inc.	T-DGDURS1-98S	Dodge Durango Std 1 Dwr, dimensions: 26L x 43.75W	\$1,895.00	\$1,622.92
336320	TruckVault Inc.	T-DGDURS2-04N	Dodge Durango Std 2 Dwr, dimensions: 42L x 48W	\$2,645.00	\$2,265.24
336320	TruckVault Inc.	T-DGDURS2-04N-PP	Dodge Durango Std 2 Dwr, dimensions: 42L x 48W	\$2,645.00	\$2,265.24
336320	TruckVault Inc.	T-DGDURS2-04N-PT	Dodge Durango Std 2 Dwr, dimensions: 41L x 46.5W	\$3,340.00	\$2,860.45
336320	TruckVault Inc.	T-DGDURS2-07N	Dodge Durango Std 2 Dwr, dimensions: 43L x 47.5W	\$2,645.00	\$2,265.24
336320	TruckVault Inc.	T-DGDURS2-07N-PP	Dodge Durango Std 2 Dwr, dimensions: 40L x 47.5W	\$2,645.00	\$2,265.24
336320	TruckVault Inc.	T-DGDURS2-07N-PT	Dodge Durango Std 2 Dwr, dimensions: 42L x 47.5W	\$3,340.00	\$2,860.45
336320	TruckVault Inc.	T-DGDURS2-11N	Dodge Durango Std 2 Dwr, dimensions: 44L x 40W	\$2,645.00	\$2,265.24
336320	TruckVault Inc.	T-DGDURS2-11N-HT	Durango Std 2 Dwr	\$3,340.00	\$2,860.45
336320	TruckVault Inc.	T-DGDURS2-11N-PP	Dodge Durango Std 2 Dwr, dimensions: 41L x 40W	\$2,645.00	\$2,265.24
336320	TruckVault Inc.	T-DGDURS2-11N-PP-TR	Dodge Durango Std 2 Dwr, dimensions: 41L x 40W	\$2,645.00	\$2,265.24
336320	TruckVault Inc.	T-DGDURS2-11N-PT	Dodge Durango Std 2 Dwr, dimensions: 42L x 40W	\$3,340.00	\$2,860.45
336320	TruckVault Inc.	T-DGDURS2-11N-TR	Dodge Durango Std 2 Dwr, dimensions: 44L x 40W	\$2,645.00	\$2,265.24
336320	TruckVault Inc.	T-DGDURS2-11N-TR-HT	Durango Std 2 Dwr	\$3,340.00	\$2,860.45
336320	TruckVault Inc.	T-DGDURS2-98M	Dodge Durango Std 2 Dwr, dimensions: 43L x 43.75W	\$2,645.00	\$2,265.24
336320	TruckVault Inc.	T-DGDURS2-98S	Dodge Durango Std 2 Dwr, dimensions: 26L x 43.75W	\$2,445.00	\$2,093.95
336320	TruckVault Inc.	T-DGDURSO-04N	Dodge Durango Std SO Dwr, dimensions: 42L x 48W	\$2,645.00	\$2,265.24
336320	TruckVault Inc.	T-DGDURSO-07N	Dodge Durango Std SO Dwr, dimensions: 43L x 47.5W	\$2,645.00	\$2,265.24
336320	TruckVault Inc.	T-DGDURSO-11N	Dodge Durango Std Offset Dwr, dimensions: 44L x 40W	\$2,645.00	\$2,265.24
336320	TruckVault Inc.	T-DGDURSO-11N-PP	Durango Std Offset Dwr	\$2,645.00	\$2,265.24
336320	TruckVault Inc.	T-DGDURSO-11N-TR	Durango Std Offset Dwr	\$2,645.00	\$2,265.24
336320	TruckVault Inc.	T-DGDURSO-98M	Dodge Durango Std OS Dwr, dimensions: 43L x 43.75W	\$2,645.00	\$2,265.24
336320	TruckVault Inc.	T-DGDURU1-11N	Durango Utility 1 Dwr	\$2,195.00	\$1,879.85
336320	TruckVault Inc.	T-DGDURU1-11N-PP-TR	Durango Utility 1 Dwr	\$2,195.00	\$1,879.85
336320	TruckVault Inc.	T-DGDURU1-11N-TR	Durango Utility 1 Dwr	\$2,195.00	\$1,879.85
336320	TruckVault Inc.	T-DGDURU1-11N-TR-HG	Durango Utility 1 Dwr	\$2,145.00	\$1,837.03
336320	TruckVault Inc.	T-DGDURU1-11N-TR-ZC10839A	Durango Utility 1 Dwr3rd Row Removed or SSV	\$1,905.00	\$1,631.49
336320	TruckVault Inc.	T-DGDURU2-11N	Durango Utility 2 Dwr	\$2,745.00	\$2,350.88
336320	TruckVault Inc.	T-DGDURU2-11N-PP-TR	Durango Utility 2 Dwr	\$2,745.00	\$2,350.88
336320	TruckVault Inc.	T-DGDURU2-11N-TR	Durango Utility 2 Dwr	\$2,745.00	\$2,350.88
336320	TruckVault Inc.	T-DGDURU2-11N-TR-HT	Durango Utility 2 Dwr	\$3,440.00	\$2,946.10
336320	TruckVault Inc.	T-DGDURUO-11N	Durango Utility OS Dwr	\$2,745.00	\$2,350.88
336320	TruckVault Inc.	T-DGGCVM1-05L	Dodge Grand Caravan Mag 1 Dwr, dimensions: 50L x 47W	\$2,435.00	\$2,085.39
336320	TruckVault Inc.	T-DGGCVM1-08L	Dodge Grand Caravan Mag 1 Dwr, dimensions: 48L x 47W	\$2,435.00	\$2,085.39
336320	TruckVault Inc.	T-DGGCVM1-08L-HT	Grand Caravan Mag 1 Dwr	\$2,990.00	\$2,560.71
336320	TruckVault Inc.	T-DGGCVM1-08L-PP	Dodge Grand Caravan Mag 1 Dwr, dimensions: 45L x 47W	\$2,295.00	\$1,965.49
336320	TruckVault Inc.	T-DGGCVM1-08L-ZC8301	Grand Caravan Mag 1 Dwr	\$2,135.00	\$1,828.46
336320	TruckVault Inc.	T-DGGCVM1-08N-Z1	Grand Caravan Mag 1 Dwr	\$2,355.00	\$2,016.88
336320	TruckVault Inc.	T-DGGCVM1-88L	Dodge Grand Caravan Mag 1 Dwr, dimensions: 47L x 47W	\$2,295.00	\$1,965.49
336320	TruckVault Inc.	T-DGGCVM1-99L	Dodge Grand Caravan Mag 1 Dwr, dimensions: 47L x 47W	\$2,295.00	\$1,965.49
336320	TruckVault Inc.	T-DGGCVM2-05L	Dodge Grand Caravan Mag 2 Dwr, dimensions: 50L x 47W	\$2,985.00	\$2,556.42
336320	TruckVault Inc.	T-DGGCVM2-05L-PT	Dodge Grand Caravan Mag 2 Dwr, dimensions: 49L x 47W	\$3,685.00	\$3,155.92
336320	TruckVault Inc.	T-DGGCVM2-08L	Dodge Grand Caravan Mag 2 Dwr, dimensions: 48L x 47W	\$2,985.00	\$2,556.42
336320	TruckVault Inc.	T-DGGCVM2-08L-HT	Grand Caravan Mag 2 DwrLWB, HD Table	\$3,540.00	\$3,031.74
336320	TruckVault Inc.	T-DGGCVM2-08L-PP	Grand Caravan Mag 2 Dwr	\$2,845.00	\$2,436.52
336320	TruckVault Inc.	T-DGGCVM2-83L	Dodge Grand Caravan Mag 2 Dwr, dimensions: 47L x 47W	\$2,845.00	\$2,436.52
336320	TruckVault Inc.	T-DGGCVM2-99L	Dodge Grand Caravan Mag 2 Dwr, dimensions: 47L x 47W	\$2,845.00	\$2,436.52
336320	TruckVault Inc.	T-DGGCVMO-08L	Dodge Grand Caravan Mag OS Dwr, dimensions: 48L x 47W	\$2,985.00	\$2,556.42
336320	TruckVault Inc.	T-DGGCVMO-08L-HT	Grand Caravan Mag OS Dwr	\$3,540.00	\$3,031.74
336320	TruckVault Inc.	T-DGGCVN0-08L-C0	Dodge Hinged Lid Box, dimensions: 22.875L x 39.5W	\$1,395.00	\$1,194.71
336320	TruckVault Inc.	T-DGGCVS1-05L	Dodge Grand Caravan Std 1 Dwr, dimensions: 53L x 47W	\$2,215.00	\$1,896.98

336320	TruckVault Inc.	T-DGGCVS1-08L	Dodge Grand Caravan Std 1 Dwr, dimensions: 50L x 47W	\$2,215.00	\$1,896.98
336320	TruckVault Inc.	T-DGGCVS1-99L	Dodge Grand Caravan Std 1 Dwr, dimensions: 47L x 47W	\$2,095.00	\$1,794.21
336320	TruckVault Inc.	T-DGGCVS2-05L	Dodge Grand Caravan Std 2 Dwr, dimensions: 53L x 47W	\$2,755.00	\$2,359.45
336320	TruckVault Inc.	T-DGGCVS2-08L	Dodge Grand Caravan Std 2 Dwr, dimensions: 50L x 47W	\$2,755.00	\$2,359.45
336320	TruckVault Inc.	T-DGGCVS2-99L	Dodge Grand Caravan Std 2 Dwr, dimensions: 47L x 47W	\$2,645.00	\$2,265.24
336320	TruckVault Inc.	T-DGGCVSO-99L	Dodge Grand Caravan Std Offset Dwr, dimensions: 47L x 47W	\$2,645.00	\$2,265.24
336320	TruckVault Inc.	T-DGGCVU2-08L-HT	Grand Caravan Utility 2 DwrHD Table	\$3,640.00	\$3,117.38
336320	TruckVault Inc.	T-DGGCVU2-08L-ZC11498	Grand Caravan Utility 2 Dwr	\$3,165.00	\$2,710.58
336320	TruckVault Inc.	T-DGJNYM1-09N	Dodge Journey Mag 1 Dwr, dimensions: 34L x 40W	\$2,095.00	\$1,794.21
336320	TruckVault Inc.	T-DGJNYM1-09N-HG	Journey Mag 1 Dwr	\$2,245.00	\$1,922.67
336320	TruckVault Inc.	T-DGJNYM1-09N-TR	Journey Mag 1 Dwr	\$2,095.00	\$1,794.21
336320	TruckVault Inc.	T-DGJNYM2-09N	Dodge Journey Mag 2 Dwr, dimensions: 34L x 40W	\$2,645.00	\$2,265.24
336320	TruckVault Inc.	T-DGJNYMO-09N	Dodge Journey Mag Offset Dwr, dimensions: 34L x 40W	\$2,645.00	\$2,265.24
336320	TruckVault Inc.	T-DGJNYS1-09N	Dodge Journey Std 1 Dwr, dimensions: 35L x 40W	\$1,895.00	\$1,622.92
336320	TruckVault Inc.	T-DGJNYS1-09N-HG	Journey Std 1 Dwr	\$2,045.00	\$1,751.39
336320	TruckVault Inc.	T-DGJNYS2-09N	Dodge Journey Std 2 Dwr, dimensions: 35L x 40W	\$2,445.00	\$2,093.95
336320	TruckVault Inc.	T-DGJNYU1-09N	Journey Utility 1 Dwr	\$1,995.00	\$1,708.56
336320	TruckVault Inc.	T-DGJNYU1-09N-HG	Journey Utility 1 Dwr	\$2,145.00	\$1,837.03
336320	TruckVault Inc.	T-DGJNYU1-09N-TR	Journey Utility 1 DwrNever Had 3rd Row	\$1,995.00	\$1,708.56
336320	TruckVault Inc.	T-DGNITM1-07N	Dodge Nitro Mag 1 Drawer, dimensions: 26.5L x 42.5W	\$2,095.00	\$1,794.21
336320	TruckVault Inc.	T-DGNITM2-07N	Dodge Nitro Mag 2 Drawer, dimensions: 26.5L x 42.5W	\$2,645.00	\$2,265.24
336320	TruckVault Inc.	T-DGNITS1-07N	Dodge Nitro Std 1 Drawer, dimensions: 29L x 42.5W	\$1,895.00	\$1,622.92
336320	TruckVault Inc.	T-DGNITS2-07N	Dodge Nitro Std 2 Drawer, dimensions: 29L x 42.5W	\$2,445.00	\$2,093.95
336320	TruckVault Inc.	T-DGPMCM2-06L	ProMaster Cargo Van	\$3,205.00	\$2,744.84
336320	TruckVault Inc.	T-DGPMCN1-01N-ZC2648	Dodge Promaster CUST 2 DwrC2648	\$2,165.00	\$1,854.16
336320	TruckVault Inc.	T-DGPMVM2-06L	ProMaster Van Mag 2 Dwr	\$3,245.00	\$2,779.09
336320	TruckVault Inc.	T-DGPMVU2-15L-PW	ProMaster Van Mag 2 DwrLWB All Weather	\$3,645.00	\$3,121.66
336320	TruckVault Inc.	T-DGRAMM1-02L-HD	Dodge Ram Mag 1 Dwr Half Width, dimensions: 92.5L x 24W	\$2,655.00	\$2,273.80
336320	TruckVault Inc.	T-DGRAMM1-02L-HD-PW	Dodge Ram Mag 1 Dwr Half Width, dimensions: 96L x 24W	\$3,245.00	\$2,779.09
336320	TruckVault Inc.	T-DGRAMM1-02L-HP	Dodge Ram Mag 1 Dwr Half Width, dimensions: 92.5L x 24W	\$2,655.00	\$2,273.80
336320	TruckVault Inc.	T-DGRAMM1-02L-HP-PW	Dodge Ram Mag 1 Dwr Half Width, dimensions: 96L x 24W	\$3,245.00	\$2,779.09
336320	TruckVault Inc.	T-DGRAMM1-02S-HD	Dodge Ram Mag 1 Dwr Half Width, dimensions: 73L x 24W	\$2,545.00	\$2,179.60
336320	TruckVault Inc.	T-DGRAMM1-02S-HD-PW	Dodge Ram Mag 1 Dwr Half Width, dimensions: 75L x 24W	\$3,045.00	\$2,607.81
336320	TruckVault Inc.	T-DGRAMM1-02S-HP	Dodge Ram Mag 1 Dwr Half Width, dimensions: 73L x 24W	\$2,545.00	\$2,179.60
336320	TruckVault Inc.	T-DGRAMM1-02S-HP-PW	Dodge Ram Mag 1 Dwr Half Width, dimensions: 75L x 24W	\$3,045.00	\$2,607.81
336320	TruckVault Inc.	T-DGRAMM1-03L-P5-HP	Ram HD Mag 1 Dwr Half Width	\$2,435.00	\$2,085.39
336320	TruckVault Inc.	T-DGRAMM1-03S-P5-HD	Dodge Ram Mag 1 Dwr, Half Width, dimensions: 73L x 24W	\$2,545.00	\$2,179.60
336320	TruckVault Inc.	T-DGRAMM1-03S-P5-HD-PW	Dodge Ram Mag 1 Dwr Half Width, dimensions: 75L x 24W	\$3,045.00	\$2,607.81
336320	TruckVault Inc.	T-DGRAMM1-03S-P5-HP	Dodge Ram Mag 1 Dwr, Half Width, dimensions: 73L x 24W	\$2,545.00	\$2,179.60
336320	TruckVault Inc.	T-DGRAMM1-03S-P5-HP-PW	Dodge Ram Mag 1 Dwr Half Width, dimensions: 75L x 24W	\$3,045.00	\$2,607.81
336320	TruckVault Inc.	T-DGRAMM1-09S-P5-TB-HN-PW	Ram Mag 1 Dwr Half Width6'3" All Wthr;Either Side	\$2,985.00	\$2,556.42
336320	TruckVault Inc.	T-DGRAMM1-09S-PC-HD	Ram Mag 1 Dwr, Half Width	\$2,435.00	\$2,085.39
336320	TruckVault Inc.	T-DGRAMM1-09S-PC-HD-PW	Dodge Ram Mag 1 Dwr Half Width, dimensions: 65L x 24W	\$2,745.00	\$2,350.88
336320	TruckVault Inc.	T-DGRAMM1-09S-PC-HP-PW	Dodge Ram Mag 1 Dwr Half Width, dimensions: 65L x 24W	\$2,745.00	\$2,350.88
336320	TruckVault Inc.	T-DGRAMM1-09S-PC-HP-RX-PW	Ram Mag 1 Dwr Half Width ReTrax5' 7", All Wthr;Passenger Side	\$2,545.00	\$2,179.60
336320	TruckVault Inc.	T-DGRAMM1-09S-PC-TB-HD	Ram Mag 1 Dwr, Half Width	\$2,105.00	\$1,802.77
336320	TruckVault Inc.	T-DGRAMM1-09S-PC-TB-HN-PW	Ram Mag 1 Dwr Half Width	\$2,625.00	\$2,248.11
336320	TruckVault Inc.	T-DGRAMM1-09S-TB-HN	Ram Mag 1 Dwr, Half Width6'3" Crew Cab, Either Side, Ram Box	\$2,215.00	\$1,896.98
336320	TruckVault Inc.	T-DGRAMM1-09S-TB-ZC9405	Ram Mag 1 Dwr Custom	\$2,365.00	\$2,025.44
336320	TruckVault Inc.	T-DGRAMM1-15S-P5-HD-DW-PW	Ram 3500 Dually Mag 1 Dwr Half Width	\$3,045.00	\$2,607.81
336320	TruckVault Inc.	T-DGRAMM1-15S-P5-HP-DW-PW	Ram 3500 Mag 1 Dwr Half Width	\$3,045.00	\$2,607.81
336320	TruckVault Inc.	T-DGRAMM1-19S-HD-PW	Ram Mag 1 Dwr Half Width	\$3,045.00	\$2,607.81
336320	TruckVault Inc.	T-DGRAMM1-19S-HP	Ram Mag 1 Dwr Half Width	\$2,545.00	\$2,179.60
336320	TruckVault Inc.	T-DGRAMM1-19S-HP-PW	Ram Mag 1 Dwr Half Width	\$3,045.00	\$2,607.81
336320	TruckVault Inc.	T-DGRAMM1-19S-PC-HD	Ram Mag 1 Dwr, Half Width	\$2,435.00	\$2,085.39
336320	TruckVault Inc.	T-DGRAMM1-19S-PC-HD-PW	Ram Mag 1 Dwr Half Width5' 7", All Wthr;Drivers Side	\$2,745.00	\$2,350.88
336320	TruckVault Inc.	T-DGRAMM1-19S-PC-HP	Ram Mag 1 Dwr, Half Width	\$2,435.00	\$2,085.39
336320	TruckVault Inc.	T-DGRAMM1-19S-PC-HP-PW	Ram Mag 1 Dwr Half Width5' 7", All Wthr;Passenger Side	\$2,745.00	\$2,350.88
336320	TruckVault Inc.	T-DGRAMM1-19S-PC-TB-HD	Ram Mag 1 Dwr, Half Width	\$2,105.00	\$1,802.77
336320	TruckVault Inc.	T-DGRAMM1-19S-RX-HD	Ram Mag 1 Dwr, Half Width ReTrax6 1/2' Crew Cab, Driver Side	\$2,295.00	\$1,965.49
336320	TruckVault Inc.	T-DGRAMM2-02L	Dodge Ram Pickup Mag 2 Dwr, dimensions: 95.5L x 48W	\$3,945.00	\$3,378.59
336320	TruckVault Inc.	T-DGRAMM2-02L-PW	Dodge Ram Pickup Mag 2 Dwr, dimensions: 96L x 48W	\$4,945.00	\$4,235.01
336320	TruckVault Inc.	T-DGRAMM2-02S	Dodge Ram Pickup Mag 2 Dwr, dimensions: 73L x 48W	\$3,745.00	\$3,207.30
336320	TruckVault Inc.	T-DGRAMM2-02S-PW	Ram Pickup Mag 2 Dwr	\$4,645.00	\$3,978.09
336320	TruckVault Inc.	T-DGRAMM2-03L-P5	Dodge Ram Pickup Mag 2 Dwr, dimensions: 95.5L x 48W	\$3,945.00	\$3,378.59

336320	TruckVault Inc.	T-DGRAMM2-03L-P5-C2-PW-ZC15509	Ram PU CUST Mag 2 Dwr No Middle Drawer	\$5,045.00	\$4,320.65
336320	TruckVault Inc.	T-DGRAMM2-03L-P5-PW	Dodge Ram Pickup Mag 2 Dwr, dimensions: 92.5L x 48W	\$4,945.00	\$4,235.01
336320	TruckVault Inc.	T-DGRAMM2-03S-HT-PW	Ram Pickup Mag 2 Dwr6' 3" Short Bed, A-Wthr; Heavy Duty Table	\$5,340.00	\$4,573.30
336320	TruckVault Inc.	T-DGRAMM2-03S-P5	Dodge Ram Pickup Mag 2 Dwr, dimensions: 73L x 48W	\$3,745.00	\$3,207.30
336320	TruckVault Inc.	T-DGRAMM2-03S-P5-HT-PW	Ram Pickup Mag 2 Dwr6' 3" HD Short Bed, A-Wthr; Heavy Duty Table	\$5,340.00	\$4,573.30
336320	TruckVault Inc.	T-DGRAMM2-03S-P5-PW	Dodge Ram Pickup Mag 2 Dwr, dimensions: 74L x 48W	\$4,645.00	\$3,978.09
336320	TruckVault Inc.	T-DGRAMM2-03S-P5-PW-ZC11015A	Ram Pickup Mag OS Dwr2 Drawer Stacked NO Wings	\$3,585.00	\$3,070.28
336320	TruckVault Inc.	T-DGRAMM2-03S-P5-PW-ZC7867	Ram Pickup Mag 2 Dwr	\$3,725.00	\$3,190.18
336320	TruckVault Inc.	T-DGRAMM2-03S-P5-ZC10449	Ram Pickup Mag 2 Dwr6' 3" Short Bed, HD Shortened to 60"	\$3,235.00	\$2,770.53
336320	TruckVault Inc.	T-DGRAMM2-03S-P5-ZC10622	Ram HD Pickup Mag 2 Dwr6' 3" SB, C10622	\$4,845.00	\$4,149.37
336320	TruckVault Inc.	T-DGRAMM2-03S-P5-ZC11275A	Ram Pickup Mag 2 Dwr Custom	\$4,165.00	\$3,567.00
336320	TruckVault Inc.	T-DGRAMM2-03S-P5-ZC9611	Ram Pickup Mag 2 Dwr Custom Length	\$3,835.00	\$3,284.38
336320	TruckVault Inc.	T-DGRAMM2-09S-P5-TB	Dodge Ram Pickup Mag 2 Drawer, dimensions: 0L x 0W	\$3,445.00	\$2,950.38
336320	TruckVault Inc.	T-DGRAMM2-09S-P5-TB-PW	Dodge Ram Pickup Mag 2 Dwr, dimensions: 75L x 48W	\$4,045.00	\$3,464.23
336320	TruckVault Inc.	T-DGRAMM2-09S-PC	Dodge Ram Pickup Mag 2 Dwr, dimensions: 64L x 49.25W	\$3,545.00	\$3,036.02
336320	TruckVault Inc.	T-DGRAMM2-09S-PC-BS	Dodge Ram Pickup Mag 2 Dwr, dimensions: 61L x 48W	\$3,245.00	\$2,779.09
336320	TruckVault Inc.	T-DGRAMM2-09S-PC-HT-PW	Ram Pickup Mag 2 Dwr	\$5,040.00	\$4,316.37
336320	TruckVault Inc.	T-DGRAMM2-09S-PC-PW	Dodge Ram Pickup Mag 2 Dwr, dimensions: 65L x 49.25W	\$4,345.00	\$3,721.16
336320	TruckVault Inc.	T-DGRAMM2-09S-PC-PW-ZC11437	Ram Pickup Mag 2 Dwr	\$4,115.00	\$3,524.18
336320	TruckVault Inc.	T-DGRAMM2-09S-PC-RX-PW	Ram Pickup Mag 2 Dwr ReTrax5' 7" SB, Crew Cab, All-Whtr	\$4,045.00	\$3,464.23
336320	TruckVault Inc.	T-DGRAMM2-09S-PC-TB	Dodge Ram Pickup Mag 2 Dwr, dimensions: 64L x 48W	\$3,245.00	\$2,779.09
336320	TruckVault Inc.	T-DGRAMM2-09S-PC-TB-PW	Dodge Ram Pickup Mag 2 Dwr, dimensions: 65.5L x 48W	\$3,745.00	\$3,207.30
336320	TruckVault Inc.	T-DGRAMM2-09S-PC-TB-RX	Ram Pickup Mag 2 Dwr5' 7" SB,Crew Cab,Tool Box ReTrax	\$2,985.00	\$2,556.42
336320	TruckVault Inc.	T-DGRAMM2-09S-PC-ZC11127	Ram Pickup Mag 2 DwrC11127	\$2,855.00	\$2,445.09
336320	TruckVault Inc.	T-DGRAMM2-09S-PC-ZC8209	Ram Pickup Mag 2 Dwr	\$3,275.00	\$2,804.79
336320	TruckVault Inc.	T-DGRAMM2-09S-TB-PW	Ram Pickup Mag 2 Dwr	\$4,045.00	\$3,464.23
336320	TruckVault Inc.	T-DGRAMM2-15L-P5-DW-PW	Ram 3500 Dually Pickup Mag 2 Dwr	\$4,945.00	\$4,235.01
336320	TruckVault Inc.	T-DGRAMM2-15S-P5-DW-PW	Ram 3500 Dually Pickup Mag 2 Dwr	\$4,645.00	\$3,978.09
336320	TruckVault Inc.	T-DGRAMM2-19S	Ram Pickup Mag 2 Dwr	\$3,545.00	\$3,036.02
336320	TruckVault Inc.	T-DGRAMM2-19S-HT-PW	Ram Pickup Mag 2 Dwr6' 3" Short Bed, A-Wthr; Heavy Duty Table	\$5,040.00	\$4,316.37
336320	TruckVault Inc.	T-DGRAMM2-19S-PC	Ram Pickup Mag 2 Dwr	\$3,545.00	\$3,036.02
336320	TruckVault Inc.	T-DGRAMM2-19S-PC-PW	Ram Pickup Mag 2 Dwr	\$4,345.00	\$3,721.16
336320	TruckVault Inc.	T-DGRAMM2-19S-PC-TB	Ram Pickup Mag 2 Dwr	\$3,245.00	\$2,779.09
336320	TruckVault Inc.	T-DGRAMM2-19S-PC-TB-PW	Ram Pickup Mag 2 Dwr5' 7" SB,Crew,Tool Box, A-Whtr	\$3,745.00	\$3,207.30
336320	TruckVault Inc.	T-DGRAMM2-19S-PC-TB-RX	Ram Pickup Mag 2 Dwr5' 7" SB,Crew Cab,Tool Box ReTrax	\$2,765.00	\$2,368.01
336320	TruckVault Inc.	T-DGRAMM2-19S-PW	Ram Pickup Mag 2 Dwr	\$4,645.00	\$3,978.09
336320	TruckVault Inc.	T-DGRAMM2-19S-RX	Ram Pickup Mag 2 Dwr6' 3" Short Bed, HD ReTrax	\$3,345.00	\$2,864.74
336320	TruckVault Inc.	T-DGRAMM2-19S-RX-PW	Ram Pickup Mag 2 Dwr6' 3" Short Bed, A-Wthr ReTrax	\$4,045.00	\$3,464.23
336320	TruckVault Inc.	T-DGRAMM2-19S-ZC11379	Ram Pickup Mag 2 Dwr	\$3,275.00	\$2,804.79
336320	TruckVault Inc.	T-DGRAMM2-20S-P5-VP	Ram Pickup Surveyor	\$3,925.00	\$3,361.46
336320	TruckVault Inc.	T-DGRAMM2-80L-ZC10729	Ram Pickup Mag 2 DwrLong Bed	\$4,005.00	\$3,429.97
336320	TruckVault Inc.	T-DGRAMM2-94L	Dodge Ram Pickup Mag 2 Dwr, dimensions: 94L x 48W	\$3,945.00	\$3,378.59
336320	TruckVault Inc.	T-DGRAMM2-94L-P5	Dodge Ram Pickup Mag 2 Dwr, dimensions: 94L x 48W	\$3,945.00	\$3,378.59
336320	TruckVault Inc.	T-DGRAMM2-94L-PW	Dodge Ram Pickup Mag 2 Dwr, dimensions: 92.5L x 48W	\$4,945.00	\$4,235.01
336320	TruckVault Inc.	T-DGRAMM2-94S	Dodge Ram Pickup Mag 2 Dwr, dimensions: 74L x 48W	\$3,745.00	\$3,207.30
336320	TruckVault Inc.	T-DGRAMM2-94S-P5	Dodge Ram Pickup Mag 2 Dwr, dimensions: 74L x 48W	\$3,745.00	\$3,207.30
336320	TruckVault Inc.	T-DGRAMM2-94S-PW	Dodge Ram Pickup Mag 2 Dwr, dimensions: 75L x 48W	\$4,645.00	\$3,978.09
336320	TruckVault Inc.	T-DGRAMM3-03L-P5-C2-PW-ZC10053	Ram PU CUST Mag 3 Dwr	\$5,445.00	\$4,663.22
336320	TruckVault Inc.	T-DGRAMM3-03S-P5-C2-PW-ZC10921	Ram HD Pickup Mag 3 DwrC10921; Gooseneck	\$5,145.00	\$4,406.30
336320	TruckVault Inc.	T-DGRAMM3-09S-P5-TB-PW-ZC9826	Dodge RamPU CUST Mag 3 Dwr	\$4,955.00	\$4,243.58
336320	TruckVault Inc.	T-DGRAMMO-02L	Dodge Ram Pickup Mag Offset Dwr, dimensions: 92.5L x 48W	\$3,945.00	\$3,378.59
336320	TruckVault Inc.	T-DGRAMMO-02L-PW	Dodge Ram Pickup Mag Offset, dimensions: 96L x 48W	\$4,945.00	\$4,235.01
336320	TruckVault Inc.	T-DGRAMMO-02S	Dodge Ram Pickup Mag OS Dwr, dimensions: 73L x 48W	\$3,745.00	\$3,207.30
336320	TruckVault Inc.	T-DGRAMMO-02S-PW	Dodge Ram Pickup Mag OS Dwr, dimensions: 75L x 48W	\$4,645.00	\$3,978.09
336320	TruckVault Inc.	T-DGRAMMO-03L-P5	Dodge Ram Pickup Mag OS Dwr, dimensions: 92.5L x 48W	\$3,945.00	\$3,378.59
336320	TruckVault Inc.	T-DGRAMMO-03L-P5-PW	Dodge Ram Pickup Mag Offset, dimensions: 96L x 48W	\$4,945.00	\$4,235.01
336320	TruckVault Inc.	T-DGRAMMO-03S-P5	Dodge Ram Pickup Mag OS Dwr, dimensions: 73L x 48W	\$3,745.00	\$3,207.30
336320	TruckVault Inc.	T-DGRAMMO-03S-P5-BS-PW	Ram Pickup Mag OS Dwr,Bedslide	\$4,645.00	\$3,978.09
336320	TruckVault Inc.	T-DGRAMMO-03S-P5-HT	Ram Pickup Mag OS Dwr6' 3" Short Bed, HD, HD Table	\$4,440.00	\$3,802.52
336320	TruckVault Inc.	T-DGRAMMO-03S-P5-PW	Dodge Ram Pickup Mag OS Dwr, dimensions: 75L x 48W	\$4,645.00	\$3,978.09
336320	TruckVault Inc.	T-DGRAMMO-03S-P5-ZC10449	Ram Pickup Mag Offset Dwr6' 3" Short Bed, HD Shortened to 60"	\$3,235.00	\$2,770.53
336320	TruckVault Inc.	T-DGRAMMO-09S-P5-TB	Dodge Ram Pickup Mag Offset, dimensions: 75L x 48W	\$3,445.00	\$2,950.38
336320	TruckVault Inc.	T-DGRAMMO-09S-P5-TB-PW	Dodge Ram Pickup Mag Offset, dimensions: 75L x 48W	\$4,045.00	\$3,464.23
336320	TruckVault Inc.	T-DGRAMMO-09S-PC	Dodge Ram Pickup Mag OS Dwr, dimensions: 64L x 53W	\$3,545.00	\$3,036.02
336320	TruckVault Inc.	T-DGRAMMO-09S-PC-HT-TB-PW	Ram Pickup Mag OS Dwr	\$4,735.00	\$4,055.16

336320	TruckVault Inc.	T-DGRAMMO-09S-PC-PW	Dodge Ram Pickup Mag Offset, dimensions: 65L x 49.25W	\$4,345.00	\$3,721.16
336320	TruckVault Inc.	T-DGRAMMO-09S-PC-RX	Ram Pickup Mag OS Dwr	\$3,345.00	\$2,864.74
336320	TruckVault Inc.	T-DGRAMMO-09S-PC-TB	Dodge Ram Pickup Mag OS Dwr, dimensions: 64L x 48W	\$3,245.00	\$2,779.09
336320	TruckVault Inc.	T-DGRAMMO-09S-PC-TB-PW	Dodge Ram Pickup Mag OS Dwr, dimensions: 65.5L x 48W	\$3,745.00	\$3,207.30
336320	TruckVault Inc.	T-DGRAMMO-09S-PC-TB-ZC10098	Ram Pickup Mag OS DwrC10098	\$3,585.00	\$3,070.28
336320	TruckVault Inc.	T-DGRAMMO-15L-P5-DW-PW	Ram 3500 Dually Pickup Mag Offset	\$4,945.00	\$4,235.01
336320	TruckVault Inc.	T-DGRAMMO-15S-P5-DW-PW	Ram 3500 Dually Pickup Mag OS Dwr	\$4,645.00	\$3,978.09
336320	TruckVault Inc.	T-DGRAMMO-19S	Ram Pickup Mag Offset Dwr	\$3,545.00	\$3,036.02
336320	TruckVault Inc.	T-DGRAMMO-19S-PC	Ram Pickup Mag OS Dwr	\$3,545.00	\$3,036.02
336320	TruckVault Inc.	T-DGRAMMO-19S-PC-PW	Ram Pickup Mag OS Dwr	\$4,345.00	\$3,721.16
336320	TruckVault Inc.	T-DGRAMMO-19S-PC-TB	Ram Pickup Mag OS Dwr	\$3,245.00	\$2,779.09
336320	TruckVault Inc.	T-DGRAMMO-19S-PC-TB-PW	Ram Pickup Mag Offset Dwr	\$3,745.00	\$3,207.30
336320	TruckVault Inc.	T-DGRAMMO-19S-PW	Ram Pickup Mag Offset Dwr	\$4,645.00	\$3,978.09
336320	TruckVault Inc.	T-DGRAMMO-20S-P5	Ram Pickup Mag OS DwrDO NOT USE	\$3,745.00	\$3,207.30
336320	TruckVault Inc.	T-DGRAMMO-20S-P5-PW	Ram Pickup Mag OS Dwr	\$4,645.00	\$3,978.09
336320	TruckVault Inc.	T-DGRAMMO-81L	Ram Pickup Mag Offset DwrLong Bed	\$3,945.00	\$3,378.59
336320	TruckVault Inc.	T-DGRAMMO-94L	Dodge Ram Pickup Mag Offset Dwr, dimensions: 94L x 48W	\$3,945.00	\$3,378.59
336320	TruckVault Inc.	T-DGRAMMO-94L-PW	Dodge Ram Pickup Mag OS Dwr, dimensions: 0L x 0W	\$4,845.00	\$4,149.37
336320	TruckVault Inc.	T-DGRAMMO-94S	Dodge Ram Pickup Mag Offset Dwr, dimensions: 74L x 48W	\$3,745.00	\$3,207.30
336320	TruckVault Inc.	T-DGRAMMO-94S-PW	Dodge Ram Pickup Mag Offset Dwr, dimensions: 75L x 48W	\$4,645.00	\$3,978.09
336320	TruckVault Inc.	T-DGRAMN1-03S-P5-HP-PW-ZC10051	Ram 12" interior 1 Dwr Half Width6' 3", All Wthr; Pass Side	\$2,815.00	\$2,410.83
336320	TruckVault Inc.	T-DGRAMN1-03S-P5-PW-ZC8206	Ram Cust 1 Dwr	\$4,125.00	\$3,532.75
336320	TruckVault Inc.	T-DGRAMN1-09S-PC-HP-PW-ZC9134	Ram Custom	\$3,635.00	\$3,113.10
336320	TruckVault Inc.	T-DGRAMN1-19S-HP-PW-ZC10051	Ram 12" interior 1 Dwr Half Width	\$2,815.00	\$2,410.83
336320	TruckVault Inc.	T-DGRAMN2-02S-ZC8985	Ram Pickup Custom	\$3,955.00	\$3,387.15
336320	TruckVault Inc.	T-DGRAMN2-03S-P5-ZC8912	Ram Pickup Custom	\$3,155.00	\$2,702.02
336320	TruckVault Inc.	T-DGRAMN2-09S-P5-TB-PW-ZC11082	Ram Pickup Custom 2 DwrC11082	\$5,475.00	\$4,688.92
336320	TruckVault Inc.	T-DGRAMN2-09S-PC-PW-ZC10824B	Ram Pickup Custom 2 DwrC10824B	\$3,905.00	\$3,344.33
336320	TruckVault Inc.	T-DGRAMN2-09S-PC-ZC8835	Ram Pickup Cust 2 Dwr	\$3,615.00	\$3,095.97
336320	TruckVault Inc.	T-DGRAMNO-09S-PC-TB-PW-ZC10415	Ram Pickup Custom 2 DwrC10415	\$4,005.00	\$3,429.97
336320	TruckVault Inc.	T-DGRAMNO-09S-TB-PW-ZC10253	Ram Pickup Custom 2 DwrC10253	\$4,005.00	\$3,429.97
336320	TruckVault Inc.	T-DGRAMS1-02L-HD	Dodge Ram Std 1 Dwr Half Width, dimensions: 92.5L x 24W	\$2,435.00	\$2,085.39
336320	TruckVault Inc.	T-DGRAMS1-02L-HD-PW	Dodge Ram Std 1 Dwr Half Width, dimensions: 96L x 24W	\$3,045.00	\$2,607.81
336320	TruckVault Inc.	T-DGRAMS1-02L-HP	Dodge Ram Std 1 Dwr Half Width, dimensions: 92.5L x 24W	\$2,435.00	\$2,085.39
336320	TruckVault Inc.	T-DGRAMS1-02L-HP-PW	Dodge Ram Std 1 Dwr Half Width, dimensions: 96L x 24W	\$3,045.00	\$2,607.81
336320	TruckVault Inc.	T-DGRAMS1-02S-HD	Dodge Ram Std 1 Dwr Half Width, dimensions: 73L x 24W	\$2,325.00	\$1,991.18
336320	TruckVault Inc.	T-DGRAMS1-02S-HD-PW	Dodge Ram Std 1 Dwr Half Width, dimensions: 75L x 24W	\$2,845.00	\$2,436.52
336320	TruckVault Inc.	T-DGRAMS1-02S-HP	Dodge Ram Std 1 Dwr Half Width, dimensions: 73L x 24W	\$2,325.00	\$1,991.18
336320	TruckVault Inc.	T-DGRAMS1-02S-HP-PW	Dodge Ram Std 1 Dwr Half Width, dimensions: 75L x 24W	\$2,845.00	\$2,436.52
336320	TruckVault Inc.	T-DGRAMS1-03L-P5-HD	Ram HD Std 1 Dwr Half Width	\$2,435.00	\$2,085.39
336320	TruckVault Inc.	T-DGRAMS1-03L-P5-HD-PW	HD Ram Mag 1 Dwr Half Width	\$3,025.00	\$2,590.68
336320	TruckVault Inc.	T-DGRAMS1-03L-P5-HP	Ram HD Std 1 Dwr Half Width	\$2,435.00	\$2,085.39
336320	TruckVault Inc.	T-DGRAMS1-03S-P5-HD	Dodge Ram Std 1 Dwr, Half Width, dimensions: 73L x 24W	\$2,325.00	\$1,991.18
336320	TruckVault Inc.	T-DGRAMS1-03S-P5-HD-PW	Dodge Ram Std 1 Dwr Half Width, dimensions: 75L x 24W	\$2,845.00	\$2,436.52
336320	TruckVault Inc.	T-DGRAMS1-03S-P5-HP	Dodge Ram Std 1 Dwr, Half Width, dimensions: 73L x 24W	\$2,325.00	\$1,991.18
336320	TruckVault Inc.	T-DGRAMS1-03S-P5-HP-PW	Dodge Ram Std 1 Dwr Half Width, dimensions: 75L x 24W	\$2,845.00	\$2,436.52
336320	TruckVault Inc.	T-DGRAMS1-09S-P5-TB-HN-PW	Ram Std 1 Dwr Half Width	\$2,845.00	\$2,436.52
336320	TruckVault Inc.	T-DGRAMS1-09S-PC-HD-PW	Dodge Ram Std 1 Dwr Half Width, dimensions: 66L x 24W	\$2,545.00	\$2,179.60
336320	TruckVault Inc.	T-DGRAMS1-09S-PC-HP-PW	Dodge Ram Std 1 Dwr Half Width, dimensions: 66L x 24W	\$2,545.00	\$2,179.60
336320	TruckVault Inc.	T-DGRAMS1-09S-PC-TB-HP	Ram Std 1 Dwr Half Width	\$1,885.00	\$1,614.36
336320	TruckVault Inc.	T-DGRAMS1-15S-P5-HD-DW-PW	Ram 3500 Dually Std 1 Dwr Half Width	\$2,845.00	\$2,436.52
336320	TruckVault Inc.	T-DGRAMS1-15S-P5-HP-DW-PW	Ram 3500 Dually Std 1 Dwr Half Width	\$2,845.00	\$2,436.52
336320	TruckVault Inc.	T-DGRAMS1-19S-HP	Ram Std 1 Dwr Half Width	\$2,125.00	\$1,819.90
336320	TruckVault Inc.	T-DGRAMS1-19S-PC-HP	Ram Std 1 Dwr Half Width5' 7" Bed; Passengers Side	\$2,215.00	\$1,896.98
336320	TruckVault Inc.	T-DGRAMS1-19S-PC-HP-PW	Ram Std 1 Dwr Half Width	\$2,545.00	\$2,179.60
336320	TruckVault Inc.	T-DGRAMS1-19S-PC-HP-RX	Ram Std 1 Dwr 1/2 Width ReTrax5' 7" Bed; Passengers Side	\$1,995.00	\$1,708.56
336320	TruckVault Inc.	T-DGRAMS2-02L	Dodge Ram Pickup Std 2 Dwr, dimensions: 92.5L x 48W	\$3,745.00	\$3,207.30
336320	TruckVault Inc.	T-DGRAMS2-02L-PW	Dodge Ram Pickup Std 2 Dwr, dimensions: 96L x 48W	\$4,745.00	\$4,063.73
336320	TruckVault Inc.	T-DGRAMS2-02S	Dodge Ram Pickup Std 2 Dwr, dimensions: 72L x 48W	\$3,545.00	\$3,036.02
336320	TruckVault Inc.	T-DGRAMS2-02S-PT	Dodge Ram Pickup Std 2 Dwr, dimensions: 73L x 48W	\$4,240.00	\$3,631.23
336320	TruckVault Inc.	T-DGRAMS2-02S-PW	Dodge Ram Pickup Std 2 Dwr, dimensions: 75L x 49.25W	\$4,445.00	\$3,806.80
336320	TruckVault Inc.	T-DGRAMS2-03L-P5	Dodge Ram Pickup Std 2 Dwr, dimensions: 92.5L x 48W	\$3,745.00	\$3,207.30
336320	TruckVault Inc.	T-DGRAMS2-03L-P5-HT-PW	Ram Pickup Std 2 Dwr	\$5,440.00	\$4,658.94
336320	TruckVault Inc.	T-DGRAMS2-03L-P5-PW	Dodge Ram Pickup Std 2 Dwr, dimensions: 96L x 48W	\$4,745.00	\$4,063.73
336320	TruckVault Inc.	T-DGRAMS2-03S-P5	Dodge Ram Pickup Std 2 Dwr, dimensions: 73L x 48W	\$3,545.00	\$3,036.02
336320	TruckVault Inc.	T-DGRAMS2-03S-P5-HT	Dodge Ram Pickup Std 2 Dwr, dimensions: 72L x 48W	\$4,240.00	\$3,631.23
336320	TruckVault Inc.	T-DGRAMS2-03S-P5-PT	Dodge Ram Pickup Std 2 Dwr Table Ext, dimensions: 73L x 48W	\$4,240.00	\$3,631.23
336320	TruckVault Inc.	T-DGRAMS2-03S-P5-PW	Dodge Ram Pickup Std 2 Dwr, dimensions: 75L x 48W	\$4,445.00	\$3,806.80

336320	TruckVault Inc.	T-DGRAMS2-09S-P5-TB	Dodge Ram Pickup Standard 2 Drawer, dimensions: 72L x 48W	\$3,045.00	\$2,607.81
336320	TruckVault Inc.	T-DGRAMS2-09S-P5-TB-PW	Dodge Ram Pickup Std 2 Dwr, dimensions: 75L x 48W	\$3,845.00	\$3,292.95
336320	TruckVault Inc.	T-DGRAMS2-09S-PC	Dodge Ram Pickup Std 2 Dwr, dimensions: 64L x 48W	\$3,345.00	\$2,864.74
336320	TruckVault Inc.	T-DGRAMS2-09S-PC-PT	Ram Pickup Std 2 Dwr	\$4,040.00	\$3,459.95
336320	TruckVault Inc.	T-DGRAMS2-09S-PC-PW	Dodge Ram Pickup Std 2 Dwr, dimensions: 66L x 53W	\$4,145.00	\$3,549.87
336320	TruckVault Inc.	T-DGRAMS2-09S-PC-TB	Dodge Ram Pickup Std 2 Dwr, dimensions: 64L x 48W	\$3,045.00	\$2,607.81
336320	TruckVault Inc.	T-DGRAMS2-09S-PC-TB-PW	Dodge Ram Pickup Std 2 Dwr, dimensions: 65.5L x 48W	\$3,545.00	\$3,036.02
336320	TruckVault Inc.	T-DGRAMS2-09S-PC-ZC8303	Ram Pickup Std 2 Dwr	\$3,055.00	\$2,616.37
336320	TruckVault Inc.	T-DGRAMS2-09S-TB	Ram Pickup Std 2 Dwr	\$3,045.00	\$2,607.81
336320	TruckVault Inc.	T-DGRAMS2-09S-TB-PW	Dodge Ram Pickup Std 2 Dwr, dimensions: 75L x 48W	\$3,845.00	\$3,292.95
336320	TruckVault Inc.	T-DGRAMS2-15L-P5-DW-PW	Ram 3500 Dually Pickup Std 2 Dwr	\$3,425.00	\$2,933.25
336320	TruckVault Inc.	T-DGRAMS2-15S-P5-DW-PW	Ram 3500 Dually Pickup Std 2 Dwr	\$4,445.00	\$3,806.80
336320	TruckVault Inc.	T-DGRAMS2-19S	Ram Pickup Std 2 Dwr	\$3,345.00	\$2,864.74
336320	TruckVault Inc.	T-DGRAMS2-19S-PC	Ram Pickup Std 2 Dwr	\$3,345.00	\$2,864.74
336320	TruckVault Inc.	T-DGRAMS2-19S-PC-PW	Ram Pickup Std 2 Dwr	\$4,145.00	\$3,549.87
336320	TruckVault Inc.	T-DGRAMS2-19S-PC-TB	Ram Pickup Std 2 Dwr	\$2,985.00	\$2,556.42
336320	TruckVault Inc.	T-DGRAMS2-19S-PC-TB-PW	Ram Pickup Std 2 Dwr	\$3,545.00	\$3,036.02
336320	TruckVault Inc.	T-DGRAMS2-19S-PC-TB-RX	Ram Pickup Std 2 Dwr5' 7" SB,Crew Cab,Tool Box Retrax	\$2,295.00	\$1,965.49
336320	TruckVault Inc.	T-DGRAMS2-19S-PW	Ram Pickup Std 2 Dwr	\$4,445.00	\$3,806.80
336320	TruckVault Inc.	T-DGRAMS2-94L	Dodge Ram Pickup Std 2 Dwr, dimensions: 93.5L x 48W	\$3,745.00	\$3,207.30
336320	TruckVault Inc.	T-DGRAMS2-94L-P5	Dodge Ram Pickup Std 2 Dwr, dimensions: 62.5L x 48W	\$3,345.00	\$2,864.74
336320	TruckVault Inc.	T-DGRAMS2-94L-P5-PW	Dodge Ram Pickup Std 2 Dwr, dimensions: 62.5L x 48W	\$4,145.00	\$3,549.87
336320	TruckVault Inc.	T-DGRAMS2-94L-PW	Dodge Ram Pickup Std 2 Dwr, dimensions: 93.5L x 48W	\$4,745.00	\$4,063.73
336320	TruckVault Inc.	T-DGRAMS2-94S	Dodge Ram Pickup Std 2 Dwr, dimensions: 75L x 48W	\$3,545.00	\$3,036.02
336320	TruckVault Inc.	T-DGRAMS2-94S-P5	Dodge Ram Pickup Std 2 Dwr, dimensions: 75L x 48W	\$3,545.00	\$3,036.02
336320	TruckVault Inc.	T-DGRAMS2-94S-P5-PW	Dodge Ram Pickup Std 2 Dwr, dimensions: 76.5L x 48W	\$4,445.00	\$3,806.80
336320	TruckVault Inc.	T-DGRAMS2-94S-PT	Dodge Ram Pickup Std 2 Dwr, dimensions: 75L x 48W	\$4,240.00	\$3,631.23
336320	TruckVault Inc.	T-DGRAMS2-94S-PW	Dodge Ram Pickup Std 2 Dwr, dimensions: 75L x 48W	\$4,445.00	\$3,806.80
336320	TruckVault Inc.	T-DGRAMS3-09S-P5-TB-PW-ZC11630	Dodge RamPU CUST Std 3 Dwr	\$4,345.00	\$3,721.16
336320	TruckVault Inc.	T-DGRAMSO-02L	Dodge Ram Pickup Std Offset Dwr, dimensions: 92.5L x 48W	\$3,745.00	\$3,207.30
336320	TruckVault Inc.	T-DGRAMSO-02S	Dodge Ram Pickup Std OS Dwr, dimensions: 73L x 48W	\$3,545.00	\$3,036.02
336320	TruckVault Inc.	T-DGRAMSO-02S-PT	Dodge Ram Pickup Std OS Dwr, dimensions: 73L x 48W	\$4,240.00	\$3,631.23
336320	TruckVault Inc.	T-DGRAMSO-02S-PW	Dodge Ram Pickup Std Offset Dwr, dimensions: 75L x 48W	\$4,445.00	\$3,806.80
336320	TruckVault Inc.	T-DGRAMSO-02S-PW-ZC8723	Ram Pickup Std Custom Offset Dwr	\$4,855.00	\$4,157.93
336320	TruckVault Inc.	T-DGRAMSO-03L-P5	Dodge Ram Pickup Std Offset Dwr, dimensions: 73L x 48W	\$3,545.00	\$3,036.02
336320	TruckVault Inc.	T-DGRAMSO-03L-P5-PW	Dodge Ram Pickup Std Offset Dwr, dimensions: 75L x 48W	\$4,445.00	\$3,806.80
336320	TruckVault Inc.	T-DGRAMSO-03S-P5	Dodge Ram Pickup Std Offset, dimensions: 73L x 48W	\$3,545.00	\$3,036.02
336320	TruckVault Inc.	T-DGRAMSO-03S-P5-PW	Dodge Ram Pickup Std OS Dwr, dimensions: 75L x 48W	\$4,445.00	\$3,806.80
336320	TruckVault Inc.	T-DGRAMSO-09S-P5-TB	Dodge Ram Pickup Standard Offset, dimensions: 72L x 48W	\$3,045.00	\$2,607.81
336320	TruckVault Inc.	T-DGRAMSO-09S-P5-TB-PW	Dodge Ram Pickup Std Offset Dwr, dimensions: 75L x 48W	\$3,845.00	\$3,292.95
336320	TruckVault Inc.	T-DGRAMSO-09S-PC	Dodge Ram Pickup Std OS Dwr, dimensions: 64L x 53W	\$3,345.00	\$2,864.74
336320	TruckVault Inc.	T-DGRAMSO-09S-PC-HT	Ram Pickup Std OS Dwr	\$4,040.00	\$3,459.95
336320	TruckVault Inc.	T-DGRAMSO-09S-PC-PW	Dodge Ram Pickup Std OS Dwr, dimensions: 66L x 53W	\$4,145.00	\$3,549.87
336320	TruckVault Inc.	T-DGRAMSO-09S-PC-TB	Ram Pickup Std OS Dwr	\$2,985.00	\$2,556.42
336320	TruckVault Inc.	T-DGRAMSO-09S-PC-TB-PW	Dodge Ram Pickup Std Offset Dwr, dimensions: 65.5L x 48W	\$3,545.00	\$3,036.02
336320	TruckVault Inc.	T-DGRAMSO-09S-PC-ZC8852	Ram Pickup Std OS Dwr	\$4,285.00	\$3,669.77
336320	TruckVault Inc.	T-DGRAMSO-15L-P5-DW-PW	Ram 3500 Dually Pickup Std Offset Dwr	\$4,445.00	\$3,806.80
336320	TruckVault Inc.	T-DGRAMSO-15S-P5-DW-PW	Ram 3500 Dually Pickup Std OS Dwr	\$4,445.00	\$3,806.80
336320	TruckVault Inc.	T-DGRAMSO-19S	Ram Pickup Std OS Dwr	\$3,345.00	\$2,864.74
336320	TruckVault Inc.	T-DGRAMSO-19S-PC	Ram Pickup Std OS Dwr	\$3,345.00	\$2,864.74
336320	TruckVault Inc.	T-DGRAMSO-19S-PC-PW	Ram Pickup Std Offset Dwr	\$4,145.00	\$3,549.87
336320	TruckVault Inc.	T-DGRAMSO-19S-PW	Ram Pickup Std Offset Dwr6' 3" Short Bed, A-Wthr	\$4,445.00	\$3,806.80
336320	TruckVault Inc.	T-DGRAMSO-94L	Dodge Ram Pickup Std Offset Dwr, dimensions: 93.5L x 48W	\$3,745.00	\$3,207.30
336320	TruckVault Inc.	T-DGRAMSO-94L-P5	Ram Pickup Std Offset Dwr	\$3,745.00	\$3,207.30
336320	TruckVault Inc.	T-DGRAMSO-94S	Dodge Ram Pickup Std OS Dwr, dimensions: 75L x 48W	\$3,545.00	\$3,036.02
336320	TruckVault Inc.	T-DGRAMSO-94S-PW	Dodge Ram Pickup Std OS Dwr, dimensions: 75L x 48W	\$4,445.00	\$3,806.80
336320	TruckVault Inc.	T-DGRAMU1-02S-HD	Ram Utility 1 Dwr Half Width6' 3" Short Bed; Drivers Side	\$2,435.00	\$2,085.39
336320	TruckVault Inc.	T-DGRAMU1-02S-HD-PW	Ram Utility 1 Dwr Half Width6' 3", All Wthr; Drivers Side	\$2,945.00	\$2,522.17
336320	TruckVault Inc.	T-DGRAMU1-02S-HP-PW	Ram Utility 1 Dwr Half Width	\$2,945.00	\$2,522.17
336320	TruckVault Inc.	T-DGRAMU1-03L-P5-HP	Ram HD Utility 1 Dwr Half Width	\$2,215.00	\$1,896.98
336320	TruckVault Inc.	T-DGRAMU1-03L-P5-HP-PW	Ram Utility 1 Dwr Half Width8", All Wthr; Passenger Side	\$3,145.00	\$2,693.45
336320	TruckVault Inc.	T-DGRAMU1-03S-P5-HD-PW	Ram Utility 1 Dwr Half Width	\$2,945.00	\$2,522.17
336320	TruckVault Inc.	T-DGRAMU1-03S-P5-HP	Ram Utility1 Dwr, Half Width6' 3"; HD; Passenger Side	\$2,435.00	\$2,085.39
336320	TruckVault Inc.	T-DGRAMU1-03S-P5-HP-PW	Ram Utility 1 Dwr Half Width	\$2,945.00	\$2,522.17
336320	TruckVault Inc.	T-DGRAMU1-09S-PC-HD	Ram Utility 1 Dwr, Half Width5' 7" Crew Cab, Driver's Side	\$2,325.00	\$1,991.18
336320	TruckVault Inc.	T-DGRAMU1-09S-PC-HD-PW	Ram Utility 1 Dwr Half Width5' 7", All Wthr; Driver's Side	\$2,645.00	\$2,265.24
336320	TruckVault Inc.	T-DGRAMU1-09S-PC-HP	Ram Utility 1 Dwr, Half Width	\$2,325.00	\$1,991.18
336320	TruckVault Inc.	T-DGRAMU1-09S-PC-HP-PW	Ram Utility 1 Dwr Half Width	\$2,645.00	\$2,265.24

336320	TruckVault Inc.	T-DGRAMU1-09S-PC-TB-HN-PW	Ram Utility 1 Dwr Half Width5' 7", All Wthr; Either Side	\$2,295.00	\$1,965.49
336320	TruckVault Inc.	T-DGRAMU1-09S-PC-TB-HP	Ram Utility 1 Dwr Half Width	\$1,995.00	\$1,708.56
336320	TruckVault Inc.	T-DGRAMU1-19S-HP-PW	Ram Utility 1 Dwr Half Width6' 3", All Wthr; Passenger Side	\$2,945.00	\$2,522.17
336320	TruckVault Inc.	T-DGRAMU1-19S-P5-HP-PW	Ram Utility 1 Dwr Half Width6' 3", All Wthr;Passenger Side	\$2,945.00	\$2,522.17
336320	TruckVault Inc.	T-DGRAMU1-19S-PC-HD	Ram Utility 1 Dwr, Half Width5' 7" Crew Cab, Driver's Side	\$2,325.00	\$1,991.18
336320	TruckVault Inc.	T-DGRAMU1-19S-PC-HD-PW	Ram Utility 1 Dwr Half Width5' 7", All Wthr; Driver's Side	\$2,645.00	\$2,265.24
336320	TruckVault Inc.	T-DGRAMU1-19S-PC-HD-RX	Ram Utility 1 Dwr, Half Width	\$2,195.00	\$1,879.85
336320	TruckVault Inc.	T-DGRAMU1-19S-PC-HP-PW	Ram Utility 1 Dwr Half Width5' 7", All Wthr;Passenger Side	\$2,645.00	\$2,265.24
336320	TruckVault Inc.	T-DGRAMU1-19S-PC-HP-RX	Ram Utility 1 Dwr, Half Width	\$2,195.00	\$1,879.85
336320	TruckVault Inc.	T-DGRAMU1-20L-P5-HP-PW	Ram Utility 1 Dwr Half Width	\$3,145.00	\$2,693.45
336320	TruckVault Inc.	T-DGRAMU2-02S	Ram Pickup Utility 2 Dwr	\$3,645.00	\$3,121.66
336320	TruckVault Inc.	T-DGRAMU2-02S-PW	Ram Pickup Utility 2 Dwr	\$4,545.00	\$3,892.44
336320	TruckVault Inc.	T-DGRAMU2-03L-P5	Ram Pickup Utility 2 Dwr	\$3,845.00	\$3,292.95
336320	TruckVault Inc.	T-DGRAMU2-03L-P5-PW	Ram Pickup Utility 2 Dwr	\$4,845.00	\$4,149.37
336320	TruckVault Inc.	T-DGRAMU2-03S-P5	Ram Pickup Utility 2 Dwr	\$3,535.00	\$3,027.46
336320	TruckVault Inc.	T-DGRAMU2-03S-P5-C1-ZC11282	Ram Pickup Utility 2 DwrShort Bed, HD	\$4,705.00	\$4,029.47
336320	TruckVault Inc.	T-DGRAMU2-03S-P5-PW	Ram Pickup Utility 2 Dwr	\$4,545.00	\$3,892.44
336320	TruckVault Inc.	T-DGRAMU2-03S-P5-ZC10764	Ram Pickup Utility 2 DwrC10764	\$3,375.00	\$2,890.43
336320	TruckVault Inc.	T-DGRAMU2-09S-P5-TB	Ram Pickup Utility2 Drawer6' 4" SB, HD, Tool Box	\$3,345.00	\$2,864.74
336320	TruckVault Inc.	T-DGRAMU2-09S-P5-TB-PW	Ram Pickup Utility 2 Dwr	\$3,945.00	\$3,378.59
336320	TruckVault Inc.	T-DGRAMU2-09S-P5-TB-ZC11120	Ram Pickup Utility 2 Dwr CustomC11120	\$2,715.00	\$2,325.19
336320	TruckVault Inc.	T-DGRAMU2-09S-PC	Ram Pickup Utility 2 Dwr	\$3,445.00	\$2,950.38
336320	TruckVault Inc.	T-DGRAMU2-09S-PC-PW	Ram Pickup Utility 2 Dwr	\$4,245.00	\$3,635.52
336320	TruckVault Inc.	T-DGRAMU2-09S-PC-TB	Ram Pickup Utility 2 Dwr	\$3,095.00	\$2,650.63
336320	TruckVault Inc.	T-DGRAMU2-09S-PC-TB-PW	Ram Pickup Utility 2 Dwr	\$3,645.00	\$3,121.66
336320	TruckVault Inc.	T-DGRAMU2-09S-TB-PW	Ram Pickup Utility 2 Dwr	\$3,945.00	\$3,378.59
336320	TruckVault Inc.	T-DGRAMU2-19S	Ram Pickup Utility 2 Dwr	\$3,445.00	\$2,950.38
336320	TruckVault Inc.	T-DGRAMU2-19S-PC	Ram Pickup Utility 2 Dwr	\$3,445.00	\$2,950.38
336320	TruckVault Inc.	T-DGRAMU2-19S-PC-PW	Ram Pickup Utility 2 Dwr	\$4,245.00	\$3,635.52
336320	TruckVault Inc.	T-DGRAMU2-19S-PC-RX	Ram Pickup Utility 2 Dwr5 1/2' Short Bed, Crew Cab; Retrax	\$3,245.00	\$2,779.09
336320	TruckVault Inc.	T-DGRAMU2-19S-PC-TB	Ram Pickup Utility 2 Dwr	\$3,095.00	\$2,650.63
336320	TruckVault Inc.	T-DGRAMU2-19S-PC-TB-PW	Ram Pickup Utility 2 Dwr	\$3,645.00	\$3,121.66
336320	TruckVault Inc.	T-DGRAMU2-19S-PC-ZC11242	Ram Pickup Utility 2 DwrC11242	\$3,165.00	\$2,710.58
336320	TruckVault Inc.	T-DGRAMU2-19S-PW	Ram Pickup Utility 2 Dwr	\$4,545.00	\$3,892.44
336320	TruckVault Inc.	T-DGRAMU2-19S-TB-ZC11120	Ram Pickup Utility 2 Dwr CustomC11120	\$2,715.00	\$2,325.19
336320	TruckVault Inc.	T-DGRAMU3-03L-P5-C2-PW-ZC11093	Ram PU CUSTUtility 3 DwrRam, LB, A-Wthr, Gooseneck; C11093	\$5,345.00	\$4,577.58
336320	TruckVault Inc.	T-DGRAMU3-03S-P5-C2-PW-ZC10541	Ram HD Pickup CUST 3 DwrC10541; Gooseneck	\$5,045.00	\$4,320.65
336320	TruckVault Inc.	T-DGRAMUO-02S	Ram Pickup Utility OS Dwr	\$3,645.00	\$3,121.66
336320	TruckVault Inc.	T-DGRAMUO-02S-PW	Ram Pickup Utility OS Dwr	\$4,545.00	\$3,892.44
336320	TruckVault Inc.	T-DGRAMUO-02S-PW-ZC9225	Ram Pickup Utility OS Dwr	\$4,975.00	\$4,260.71
336320	TruckVault Inc.	T-DGRAMUO-03L-P5	Ram Pickup Utility 2 Dwr	\$3,845.00	\$3,292.95
336320	TruckVault Inc.	T-DGRAMUO-03L-P5-PW	Ram Pickup Utility Offset Dwr	\$4,845.00	\$4,149.37
336320	TruckVault Inc.	T-DGRAMUO-03S-P5	Ram Pickup Utility OS Dwr	\$3,645.00	\$3,121.66
336320	TruckVault Inc.	T-DGRAMUO-03S-P5-PW	Ram Pickup Utility Offset Dwr	\$4,545.00	\$3,892.44
336320	TruckVault Inc.	T-DGRAMUO-03S-P5-ZC10967A	Ram Pickup Utility OS DwrC10967A	\$3,925.00	\$3,361.46
336320	TruckVault Inc.	T-DGRAMUO-09S-PC	Ram Pickup Utility OS Dwr	\$3,445.00	\$2,950.38
336320	TruckVault Inc.	T-DGRAMUO-09S-PC-PW	Ram Pickup Utility OS Dwr	\$4,245.00	\$3,635.52
336320	TruckVault Inc.	T-DGRAMUO-09S-PC-PW-ZC9698	Ram Pickup Utility OS Dwr	\$3,955.00	\$3,387.15
336320	TruckVault Inc.	T-DGRAMUO-09S-PC-TB	Ram Pickup Utility 2 Dwr Offset5' 7" SB,Crew Cab,Tool Box	\$3,095.00	\$2,650.63
336320	TruckVault Inc.	T-DGRAMUO-09S-PC-TB-PW	Ram Pickup Utility Offset Dwr	\$3,645.00	\$3,121.66
336320	TruckVault Inc.	T-DGRAMUO-09S-TB-PW	Ram Pickup Utility 2 Dwr Offset6' 4" SB, A-Wthr,Tool Box	\$3,945.00	\$3,378.59
336320	TruckVault Inc.	T-DGRAMUO-19S	Ram Pickup Utility OS Dwr6' 3" Short Bed	\$3,445.00	\$2,950.38
336320	TruckVault Inc.	T-DGRAMUO-19S-PC	Ram Pickup Utility 2 Dwr Offset5 1/2' Short Bed, Crew Cab	\$3,445.00	\$2,950.38
336320	TruckVault Inc.	T-DGRAMUO-19S-PC-PW	Ram Pickup Utility OS Dwr	\$4,245.00	\$3,635.52
336320	TruckVault Inc.	T-DGRAMUO-19S-PC-TB-PW	Ram Pickup Utility Offset Dwr	\$3,645.00	\$3,121.66
336320	TruckVault Inc.	T-DGRAMUO-19S-PW	Ram Pickup Utility Offset Dwr	\$4,545.00	\$3,892.44
336320	TruckVault Inc.	T-DGRAMUO-19S-PW-C1-ZC11124G	Ram Pickup Utility 2 Dwr Offset All Weather	\$6,365.00	\$5,451.13
336320	TruckVault Inc.	T-FDAERM1-92S	Ford Aerostar Mag 1 Dwr, dimensions: 47L x 47W	\$2,295.00	\$1,965.49
336320	TruckVault Inc.	T-FDAERM2-92L	Ford Aerostar Mag 2 Dwr, dimensions: 47L x 47W	\$2,845.00	\$2,436.52
336320	TruckVault Inc.	T-FDAERM2-92S	Ford Aerostar Mag 2 Dwr, dimensions: 47L x 47W	\$2,845.00	\$2,436.52
336320	TruckVault Inc.	T-FDAERS1-86S	Ford Aerostar Std 1 Dwr, dimensions: 47L x 47W	\$2,095.00	\$1,794.21
336320	TruckVault Inc.	T-FDAERS2-86L	Ford Aerostar Std 2 Dwr, dimensions: 47L x 47W	\$2,645.00	\$2,265.24
336320	TruckVault Inc.	T-FDAERS2-86S	Ford Aerostar Std 2 Dwr, dimensions: 47L x 47W	\$2,645.00	\$2,265.24
336320	TruckVault Inc.	T-FDBCOM1-85N	Bronco FS Mag 1 Dwr	\$2,095.00	\$1,794.21
336320	TruckVault Inc.	T-FDBCOM1-88N	Ford Bronco FS Mag 1 Dwr, dimensions: 34.75L x 50W	\$2,095.00	\$1,794.21
336320	TruckVault Inc.	T-FDBCOM2-85N	Ford Bronco FS Mag 2 Dwr, dimensions: 1L x 1W	\$2,645.00	\$2,265.24
336320	TruckVault Inc.	T-FDBCOM2-88N	Ford Bronco FS Mag 2 Dwr, dimensions: 34.75L x 50W	\$2,645.00	\$2,265.24
336320	TruckVault Inc.	T-FDBCOS1-80N-ZC10150	Bronco FS Std 1 DwrC10150	\$2,745.00	\$2,350.88
336320	TruckVault Inc.	T-FDBCOS1-88N	Ford Bronco FS Std 1 Dwr, dimensions: 34.75L x 47W	\$1,895.00	\$1,622.92
336320	TruckVault Inc.	T-FDBCOS1-88N-ZC10150	Bronco FS Std 1 DwrC10150	\$2,745.00	\$2,350.88

336320	TruckVault Inc.	T-FDBCOS2-85N	Ford Bronco FS Std 2 Dwr, dimensions: 34.75L x 47W	\$2,445.00	\$2,093.95
336320	TruckVault Inc.	T-FDBCOS2-88N	Ford Bronco FS Std 2 Dwr, dimensions: 34.75L x 47W	\$2,445.00	\$2,093.95
336320	TruckVault Inc.	T-FDBCOSL-88N	Ford Bronco FS Std L Dwr, dimensions: 34.75L x 47W	\$2,025.00	\$1,734.26
336320	TruckVault Inc.	T-FDBCOSU1-88N	Bronco FS Utility 1 Dwr	\$1,995.00	\$1,708.56
336320	TruckVault Inc.	T-FDBCOSM1-21N	Bronco Sport Mag 1 Dwr	\$1,895.00	\$1,622.92
336320	TruckVault Inc.	T-FDBCOSM2-21N	Bronco Sport Mag 2 Dwr	\$1,895.00	\$1,622.92
336320	TruckVault Inc.	T-FDBCOS1-21N	Bronco Sport Std 1 Dwr	\$1,895.00	\$1,622.92
336320	TruckVault Inc.	T-FDBCOS2-21N	Bronco Sport Std 2 Dwr	\$1,895.00	\$1,622.92
336320	TruckVault Inc.	T-FDBCOSU1-21N	Bronco Sport Utility 1 Dwr	\$1,895.00	\$1,622.92
336320	TruckVault Inc.	T-FDBCOSU2-21N	Bronco Sport Utility 2 Dwr	\$1,895.00	\$1,622.92
336320	TruckVault Inc.	T-FDCMXM1-11N	C-Max Mag 1 Dwr	\$1,895.00	\$1,622.92
336320	TruckVault Inc.	T-FDEDGM1-07N	Ford Edge Mag 1 Dwr, dimensions: 30L x 38.5W	\$2,095.00	\$1,794.21
336320	TruckVault Inc.	T-FDEDGM1-07N-PT	Ford Edge Mag 1 Dwr, dimensions: 30L x 38.5W	\$2,790.00	\$2,389.42
336320	TruckVault Inc.	T-FDEDGM1-11N	Ford Edge Mag 1 Dwr, dimensions: 28L x 41W	\$2,095.00	\$1,794.21
336320	TruckVault Inc.	T-FDEDGM1-11N-HG	Edge Mag 1 Dwr	\$2,045.00	\$1,751.39
336320	TruckVault Inc.	T-FDEDGM1-15N	Ford Edge Mag 1 Dwr, dimensions: 31L x 43W	\$2,095.00	\$1,794.21
336320	TruckVault Inc.	T-FDEDGM1-15N-HG	Edge Mag 1 Dwr	\$2,245.00	\$1,922.67
336320	TruckVault Inc.	T-FDEDGM2-07N	Ford Edge Mag 2 Dwr, dimensions: 30L x 38.5W	\$2,645.00	\$2,265.24
336320	TruckVault Inc.	T-FDEDGM2-11N	Ford Edge Mag 2 Dwr, dimensions: 28L x 41W	\$2,645.00	\$2,265.24
336320	TruckVault Inc.	T-FDEDGM2-15N	Edge Mag 2 Dwr	\$2,645.00	\$2,265.24
336320	TruckVault Inc.	T-FDEDGM2-15N-HG	Edge Mag 2 DwrElevated Version	\$2,645.00	\$2,265.24
336320	TruckVault Inc.	T-FDEDGMO-07N	Ford Edge Mag OS Dwr, dimensions: 0L x 0W	\$2,645.00	\$2,265.24
336320	TruckVault Inc.	T-FDEDGMO-11N	Ford Edge Mag OS Dwr, dimensions: 28L x 41W	\$2,645.00	\$2,265.24
336320	TruckVault Inc.	T-FDEDGMO-15N	Ford Edge Mag OS Dwr, dimensions: 31L x 43W	\$2,645.00	\$2,265.24
336320	TruckVault Inc.	T-FDEDGS1-07N	Ford Ford Edge, dimensions: 32L x 41W	\$1,895.00	\$1,622.92
336320	TruckVault Inc.	T-FDEDGS1-07N-PT	Ford Edge Std 1 Dwr, dimensions: 31L x 38.5W	\$2,590.00	\$2,218.14
336320	TruckVault Inc.	T-FDEDGS1-11N	Ford Edge Std 1 Dwr, dimensions: 30L x 41W	\$1,895.00	\$1,622.92
336320	TruckVault Inc.	T-FDEDGS1-11N-PT	Ford Edge Std 1 Dwr, dimensions: 29L x 41W	\$2,590.00	\$2,218.14
336320	TruckVault Inc.	T-FDEDGS1-15N	Ford Edge Std 1 Dwr, dimensions: 33L x 43W	\$1,895.00	\$1,622.92
336320	TruckVault Inc.	T-FDEDGS1-15N-HG	Edge Std 1 Dwr	\$2,045.00	\$1,751.39
336320	TruckVault Inc.	T-FDEDGS1-15N-PT	Ford Edge Std 1 Dwr, dimensions: 32L x 43W	\$2,590.00	\$2,218.14
336320	TruckVault Inc.	T-FDEDGS2-07N	Ford Edge Std 2 Dwr, dimensions: 32L x 41W	\$2,445.00	\$2,093.95
336320	TruckVault Inc.	T-FDEDGS2-11N	Ford Edge Std 2 Dwr, dimensions: 30L x 41W	\$1,995.00	\$1,708.56
336320	TruckVault Inc.	T-FDEDGS2-15N	Edge Std 2 Dwr	\$2,445.00	\$2,093.95
336320	TruckVault Inc.	T-FDEDGU1-15N-HG	Edge Utility 1 Dwr	\$2,075.00	\$1,777.08
336320	TruckVault Inc.	T-FDESCM1-01N	Ford Escape Mag 1 Dwr, dimensions: 25.5L x 43W	\$2,095.00	\$1,794.21
336320	TruckVault Inc.	T-FDESCM1-05N	Ford Escape Mag 1 Dwr, dimensions: 27L x 37W	\$2,095.00	\$1,794.21
336320	TruckVault Inc.	T-FDESCM1-05N-PH	Ford Escape Mag 1 Dwr, dimensions: 27L x 37W	\$2,095.00	\$1,794.21
336320	TruckVault Inc.	T-FDESCM1-08N	Ford Escape Mag 1 Dwr, dimensions: 24L x 40W	\$2,095.00	\$1,794.21
336320	TruckVault Inc.	T-FDESCM1-08N-PH	Ford Escape Mag 1 Dwr, dimensions: 26L x 40W	\$2,095.00	\$1,794.21
336320	TruckVault Inc.	T-FDESCM1-08N-PT	Ford Escape Mag 1 Dwr, dimensions: 25L x 40.25W	\$2,790.00	\$2,389.42
336320	TruckVault Inc.	T-FDESCM1-14N	Ford Escape Mag 1 Dwr, dimensions: 24L x 39W	\$2,095.00	\$1,794.21
336320	TruckVault Inc.	T-FDESCM1-14N-HG	Escape Mag 1 Dwr Hanging Design	\$2,245.00	\$1,922.67
336320	TruckVault Inc.	T-FDESCM1-20N	Escape Mag 1 DwrWill fit Hybrids	\$2,095.00	\$1,794.21
336320	TruckVault Inc.	T-FDESCM1-20N-HG	Escape Mag 1 Dwr Hanging Design	\$2,045.00	\$1,751.39
336320	TruckVault Inc.	T-FDESCM2-01N	Ford Escape Mag 2 Dwr, dimensions: 25.5L x 43W	\$2,645.00	\$2,265.24
336320	TruckVault Inc.	T-FDESCM2-05N	Ford Escape Mag 2 Dwr, dimensions: 27L x 37W	\$2,645.00	\$2,265.24
336320	TruckVault Inc.	T-FDESCM2-05N-PH	Ford Escape Mag 2 Dwr, dimensions: 27L x 37W	\$2,645.00	\$2,265.24
336320	TruckVault Inc.	T-FDESCM2-05N-PT	Ford Escape Mag 2 Dwr, dimensions: 26L x 37W	\$3,340.00	\$2,860.45
336320	TruckVault Inc.	T-FDESCM2-08N	Ford Escape Mag 2 Dwr, dimensions: 24L x 40W	\$2,645.00	\$2,265.24
336320	TruckVault Inc.	T-FDESCM2-08N-PH	Ford Escape Mag 2 Dwr, dimensions: 26L x 40W	\$2,645.00	\$2,265.24
336320	TruckVault Inc.	T-FDESCM2-08N-PT	Ford Escape Mag 2 Dwr, dimensions: 26L x 40W	\$3,340.00	\$2,860.45
336320	TruckVault Inc.	T-FDESCM2-14N	Ford Escape Mag 2 Dwr, dimensions: 24L x 39W	\$2,645.00	\$2,265.24
336320	TruckVault Inc.	T-FDESCMO-01N	Ford Escape Mag OS Dwr, dimensions: 25.5L x 43W	\$2,645.00	\$2,265.24
336320	TruckVault Inc.	T-FDESCMO-05N-PT	Ford Escape Mag OS Dwr, dimensions: 26L x 37W	\$3,340.00	\$2,860.45
336320	TruckVault Inc.	T-FDESCMO-08N	Ford Escape Mag OS Dwr, dimensions: 24L x 40W	\$2,645.00	\$2,265.24
336320	TruckVault Inc.	T-FDESCMO-08N-PT	Ford Escape Mag OS Dwr, dimensions: 24L x 40W	\$3,340.00	\$2,860.45
336320	TruckVault Inc.	T-FDESCMO-13N	Ford Escape Mag OS Dwr, dimensions: 25L x 39W	\$2,645.00	\$2,265.24
336320	TruckVault Inc.	T-FDESCMO-14N	Ford Escape Mag OS Dwr, dimensions: 24L x 39W	\$2,645.00	\$2,265.24
336320	TruckVault Inc.	T-FDESCN1-14N-HG	Escape 1 Dwr Hanging Design	\$2,145.00	\$1,837.03
336320	TruckVault Inc.	T-FDESCN2-14N-ZC8160	Escape CUST 2 Dwr	\$2,485.00	\$2,128.21
336320	TruckVault Inc.	T-FDESCS1-01N	Ford Escape Std 1 Dwr, dimensions: 29L x 41.75W	\$1,895.00	\$1,622.92
336320	TruckVault Inc.	T-FDESCS1-05N	Ford Escape Std 1 Dwr, dimensions: 29.5L x 37W	\$1,895.00	\$1,622.92
336320	TruckVault Inc.	T-FDESCS1-05N-PH	Ford Escape Std 1 Dwr, dimensions: 29.5L x 37W	\$1,895.00	\$1,622.92
336320	TruckVault Inc.	T-FDESCS1-08N	Ford Escape Std 1 Dwr, dimensions: 26L x 40W	\$1,895.00	\$1,622.92
336320	TruckVault Inc.	T-FDESCS1-08N-PH	Ford Escape Std 1 Dwr, dimensions: 28L x 40W	\$1,895.00	\$1,622.92
336320	TruckVault Inc.	T-FDESCS1-08N-PH-PP	Ford Escape Std 1 Dwr, dimensions: 25L x 40W	\$1,895.00	\$1,622.92
336320	TruckVault Inc.	T-FDESCS1-13N	Ford Escape Std 1 Dwr, dimensions: 26L x 39W	\$1,895.00	\$1,622.92
336320	TruckVault Inc.	T-FDESCS1-14N	Ford Escape Std 1 Dwr, dimensions: 26L x 39W	\$1,895.00	\$1,622.92
336320	TruckVault Inc.	T-FDESCS1-14N-HG	Escape Std 1 Dwr Hanging Design	\$2,045.00	\$1,751.39
336320	TruckVault Inc.	T-FDESCS1-20N	Escape Std 1 DwrWill fit Hybrids	\$1,895.00	\$1,622.92



336320	TruckVault Inc.	T-FDESCS1-20N-HG	Escape Std 1 Dwr Hanging DesignWill fit Hybrids	\$1,845.00	\$1,580.10
336320	TruckVault Inc.	T-FDESCS2-01N	Ford Escape Std 2 Dwr, dimensions: 29L x 41.75W	\$2,445.00	\$2,093.95
336320	TruckVault Inc.	T-FDESCS2-05N	Ford Escape Std 2 Dwr, dimensions: 29.5L x 37W	\$2,445.00	\$2,093.95
336320	TruckVault Inc.	T-FDESCS2-05N-PH	Ford Escape Std 2 Dwr, dimensions: 29.5L x 37W	\$2,445.00	\$2,093.95
336320	TruckVault Inc.	T-FDESCS2-05N-PT	Ford Escape Std 2 Dwr, dimensions: 27L x 37W	\$3,140.00	\$2,689.17
336320	TruckVault Inc.	T-FDESCS2-08N	Ford Escape Std 2 Dwr, dimensions: 26L x 40W	\$2,445.00	\$2,093.95
336320	TruckVault Inc.	T-FDESCS2-08N-PH	Ford Escape Hybrid Std 2 Dwr, dimensions: 28L x 40W	\$2,445.00	\$2,093.95
336320	TruckVault Inc.	T-FDESCS2-08N-PH-PT	Ford Escape Hybrid Std 2 Dwr, dimensions: 27.5L x 40W	\$3,140.00	\$2,689.17
336320	TruckVault Inc.	T-FDESCS2-13N	Ford Escape Std 2 Dwr, dimensions: 26L x 39W	\$2,445.00	\$2,093.95
336320	TruckVault Inc.	T-FDESCS2-13N-PT	Ford Escape Std 2 Dwr, dimensions: 26L x 39W	\$3,140.00	\$2,689.17
336320	TruckVault Inc.	T-FDESCS2-14N	Escape Std 2 Dwr	\$2,445.00	\$2,093.95
336320	TruckVault Inc.	T-FDESCS2-20N	Escape Std 2 Dwr	\$2,445.00	\$2,093.95
336320	TruckVault Inc.	T-FDESCSO-01N	Ford Escape Std OS Dwr, dimensions: 29L x 37W	\$2,445.00	\$2,093.95
336320	TruckVault Inc.	T-FDESCSO-08N	Ford Escape Std OS Dwr, dimensions: 26L x 40W	\$2,445.00	\$2,093.95
336320	TruckVault Inc.	T-FDESCU1-14N-HG	Escape Utility 1 Dwr Hanging Design	\$2,145.00	\$1,837.03
336320	TruckVault Inc.	T-FDESCU1-20N	Escape Utility 1 DwrWill fit Hybrids	\$1,995.00	\$1,708.56
336320	TruckVault Inc.	T-FDESCU1-20N-HG	Escape Utility 1 Dwr Hanging DesignWill fit Hybrids	\$1,945.00	\$1,665.74
336320	TruckVault Inc.	T-FDESEM1-06L	Ford Full Size Van Mag 1 Dwr, dimensions: 50L x 48W	\$2,435.00	\$2,085.39
336320	TruckVault Inc.	T-FDESEM2-06L	Ford Full Size Van Mag 2 Dwr, dimensions: 50L x 48W	\$2,985.00	\$2,556.42
336320	TruckVault Inc.	T-FDESEM2-06L-PT	Ford Full Size Van Mag 2 Dwr, dimensions: 50L x 48W	\$3,685.00	\$3,155.92
336320	TruckVault Inc.	T-FDESEM2-98L	Ford Full Size Van Mag 2 Dwr, dimensions: 74L x 48W	\$3,445.00	\$2,950.38
336320	TruckVault Inc.	T-FDESEMO-06L	Ford Full Size Van Mag OS Dwr, dimensions: 50L x 48W	\$2,985.00	\$2,556.42
336320	TruckVault Inc.	T-FDESEMO-06L-PT	Ford Full Size Van Mag OS Table Ext, dimensions: 48L x 48W	\$3,685.00	\$3,155.92
336320	TruckVault Inc.	T-FDESEMO-92M-PT	Full Size Van Mag 2 DwrMid Size E-350 pullout table	\$3,540.00	\$3,031.74
336320	TruckVault Inc.	T-FDESES1-06L	Ford Full Size Van Std 1 Dwr, dimensions: 50L x 48W	\$2,215.00	\$1,896.98
336320	TruckVault Inc.	T-FDESES2-06L	Ford Full Size Van Std 2 Dwr, dimensions: 50L x 48W	\$2,755.00	\$2,359.45
336320	TruckVault Inc.	T-FDESES2-06L-PT	Ford Full Size Van Std 2 Dwr, dimensions: 50L x 48W	\$3,465.00	\$2,967.51
336320	TruckVault Inc.	T-FDESES2-92S	Full Size Van Std 2 Dwr	\$2,245.00	\$1,922.67
336320	TruckVault Inc.	T-FDESES2-98L	Ford Full Size Van Std 2 Dwr, dimensions: 62L x 48W	\$2,985.00	\$2,556.42
336320	TruckVault Inc.	T-FDESESO-06L	Ford Full Size Van Std OS Dwr, dimensions: 62L x 48W	\$2,985.00	\$2,556.42
336320	TruckVault Inc.	T-FDESEU2-06L	Full Size Van Utility 2 Dwr	\$2,745.00	\$2,350.88
336320	TruckVault Inc.	T-FDESEU2-06L-ZC8650	Full Size Van Utility 2 Dwr	\$3,155.00	\$2,702.02
336320	TruckVault Inc.	T-FDEXCM1-00S	Ford Excursion Mag 1 Dwr, dimensions: 33L x 45W	\$2,095.00	\$1,794.21
336320	TruckVault Inc.	T-FDEXCM1-00S-PT	Ford Excursion Mag 1 Dwr, dimensions: 33L x 45W	\$2,790.00	\$2,389.42
336320	TruckVault Inc.	T-FDEXCM1-00S-SR	Excursion Mag 1 Dwr	\$2,095.00	\$1,794.21
336320	TruckVault Inc.	T-FDEXCM2-00F	Ford Excursion Mag 2 Dwr, dimensions: 65L x 45W	\$3,245.00	\$2,779.09
336320	TruckVault Inc.	T-FDEXCM2-00F-PT	Ford Excursion Mag 2 Dwr, dimensions: 64L x 45W	\$3,940.00	\$3,374.31
336320	TruckVault Inc.	T-FDEXCM2-00F-SR	Ford Excursion Mag 2 Dwr, dimensions: 65L x 48W	\$3,245.00	\$2,779.09
336320	TruckVault Inc.	T-FDEXCM2-00F-SR-ZC11667	Excursion Mag 2 Dwr	\$2,925.00	\$2,505.04
336320	TruckVault Inc.	T-FDEXCM2-00M	Ford Excursion Mag 2 Dwr, dimensions: 58L x 45W	\$3,045.00	\$2,607.81
336320	TruckVault Inc.	T-FDEXCM2-00M-SR	Excursion Mag 2 Dwr	\$3,045.00	\$2,607.81
336320	TruckVault Inc.	T-FDEXCMO-00F	Ford Excursion Mag OS Dwr, dimensions: 65L x 45W	\$3,245.00	\$2,779.09
336320	TruckVault Inc.	T-FDEXCMO-00F-PT	Ford Excursion Mag OS Dwr, dimensions: 64L x 45W	\$3,940.00	\$3,374.31
336320	TruckVault Inc.	T-FDEXCMO-00F-PT-ZC8821	Excursion Custom	\$3,725.00	\$3,190.18
336320	TruckVault Inc.	T-FDEXCMO-00F-PT-ZC8885	Excursion Custom	\$3,785.00	\$3,241.56
336320	TruckVault Inc.	T-FDEXCMO-00F-SR	Ford Excursion Mag OS Dwr, dimensions: 65L x 48W	\$3,245.00	\$2,779.09
336320	TruckVault Inc.	T-FDEXCMO-00M	Ford Excursion Mag OS Dwr, dimensions: 58L x 45W	\$3,045.00	\$2,607.81
336320	TruckVault Inc.	T-FDEXCMO-00M-PT	Ford Excursion Mag OS Dwr, dimensions: 58L x 45W	\$3,740.00	\$3,203.02
336320	TruckVault Inc.	T-FDEXCMO-00M-SR	Ford Excursion Mag OS Dwr, dimensions: 58L x 48W	\$3,045.00	\$2,607.81
336320	TruckVault Inc.	T-FDEXCMO-00N-ZC9001	Excursion Custom	\$2,585.00	\$2,213.85
336320	TruckVault Inc.	T-FDEXCMO-00S	Ford Excursion Mag OS Dwr, dimensions: 33L x 45W	\$2,645.00	\$2,265.24
336320	TruckVault Inc.	T-FDEXCS1-00S	Ford Excursion Std 1 Dwr, dimensions: 33L x 45W	\$1,895.00	\$1,622.92
336320	TruckVault Inc.	T-FDEXCS2-00F	Ford Excursion Std 2 Dwr, dimensions: 65L x 45W	\$2,985.00	\$2,556.42
336320	TruckVault Inc.	T-FDEXCS2-00F-HT	Excursion Std 2 Dwr	\$3,740.00	\$3,203.02
336320	TruckVault Inc.	T-FDEXCS2-00F-SR	Excursion Std 2 Dwr	\$2,985.00	\$2,556.42
336320	TruckVault Inc.	T-FDEXCS2-00M	Ford Excursion Std 2 Dwr, dimensions: 58L x 45W	\$2,845.00	\$2,436.52
336320	TruckVault Inc.	T-FDEXCS2-00M-PT	Ford Excursion Std 2 Dwr, dimensions: 58L x 45W	\$3,540.00	\$3,031.74
336320	TruckVault Inc.	T-FDEXCS2-00S	Ford Excursion Std 2 Dwr, dimensions: 33L x 45W	\$2,445.00	\$2,093.95
336320	TruckVault Inc.	T-FDEXCSO-00F	Ford Excursion Std OS Dwr, dimensions: 65L x 45W	\$2,985.00	\$2,556.42
336320	TruckVault Inc.	T-FDEXCSO-00F-PP	Ford Excursion Std OS Dwr, dimensions: 62L x 45W	\$2,985.00	\$2,556.42
336320	TruckVault Inc.	T-FDEXCSO-00F-PT	Ford Excursion Std OS Dwr, dimensions: 65L x 45W	\$3,685.00	\$3,155.92
336320	TruckVault Inc.	T-FDEXCSO-00F-SR	Ford Excursion Std OS Dwr, dimensions: 65L x 48W	\$2,985.00	\$2,556.42
336320	TruckVault Inc.	T-FDEXCSO-00F-SR-HT	Excursion Std OS Dwr HD Table	\$3,740.00	\$3,203.02
336320	TruckVault Inc.	T-FDEXCSO-00M	Ford Excursion Std OS Dwr, dimensions: 58L x 45W	\$2,845.00	\$2,436.52
336320	TruckVault Inc.	T-FDEXCSO-00S	Ford Excursion Std OS Dwr, dimensions: 33L x 45W	\$2,445.00	\$2,093.95
336320	TruckVault Inc.	T-FDEXCU1-00M-SR	Excursion Utility 1 DwrM-Size, Spare Removed	\$2,325.00	\$1,991.18
336320	TruckVault Inc.	T-FDEXCU1-00S	Excursion Utility 1 Dwr	\$1,995.00	\$1,708.56
336320	TruckVault Inc.	T-FDEXCU2-00F	Excursion Utility 2 DwrF-Size	\$3,095.00	\$2,650.63
336320	TruckVault Inc.	T-FDEXCU2-00F-PT	Excursion Utility 2 DwrPullout Table; F-Size	\$3,840.00	\$3,288.66
336320	TruckVault Inc.	T-FDEXCU2-00M-SR	Excursion Utility 2 DwrMid-Size Spare Removed	\$2,945.00	\$2,522.17
336320	TruckVault Inc.	T-FDEXCU2-00M-SR-HT	Excursion Utility 2 Dwr HD Table	\$3,640.00	\$3,117.38
336320	TruckVault Inc.	T-FDEXCUO-00F	Excursion Utility 2 Dwr Offset-F-Size	\$3,095.00	\$2,650.63

336320	TruckVault Inc.	T-FDEXCUO-00F-HT	Excursion Utility OS Dwr	\$3,840.00	\$3,288.66
336320	TruckVault Inc.	T-FDEXCUO-00F-SR	Excursion Utility OS Dwr	\$3,095.00	\$2,650.63
336320	TruckVault Inc.	T-FDEXCUO-00M	Excursion Utility OS Dwr	\$2,945.00	\$2,522.17
336320	TruckVault Inc.	T-FDEXCUO-00M-SR	Excursion Utility OS DwrMid-Size Spare Removed	\$2,945.00	\$2,522.17
336320	TruckVault Inc.	T-FDEXCUO-00S	Excursion Utility OS Dwr	\$2,545.00	\$2,179.60
336320	TruckVault Inc.	T-FDEXLM1-07M	Ford Expedition EL Mag 1 Dwr, dimensions: 52L x 48W	\$2,435.00	\$2,085.39
336320	TruckVault Inc.	T-FDEXLM1-07M-HD	Expedition EL Mag 1 Dwr	\$1,995.00	\$1,708.56
336320	TruckVault Inc.	T-FDEXLM1-07M-TR	Ford Expedition EL Mag 1 Dwr, dimensions: 52L x 48W	\$2,435.00	\$2,085.39
336320	TruckVault Inc.	T-FDEXLM1-07S	Ford Expedition EL Mag 1 Dwr, dimensions: 27L x 48W	\$2,095.00	\$1,794.21
336320	TruckVault Inc.	T-FDEXLM1-07S-PT	Ford Expedition EL Mag 1 Dwr, dimensions: 26L x 48W	\$2,790.00	\$2,389.42
336320	TruckVault Inc.	T-FDEXLM2-07F	Ford Expedition EL Mag 2 Dwr, dimensions: 60L x 48W	\$3,245.00	\$2,779.09
336320	TruckVault Inc.	T-FDEXLM2-07F-HT	Expedition EL Mag 2 Dwr	\$3,740.00	\$3,203.02
336320	TruckVault Inc.	T-FDEXLM2-07F-PP	Ford Expedition EL Mag 2 Dwr, dimensions: 57L x 48W	\$3,045.00	\$2,607.81
336320	TruckVault Inc.	T-FDEXLM2-07F-PT	Ford Expedition EL Mag 2 Dwr, dimensions: 59L x 48W	\$3,740.00	\$3,203.02
336320	TruckVault Inc.	T-FDEXLM2-07F-TR	Ford Expedition EL Mag 2 Dwr, dimensions: 60L x 48W	\$3,245.00	\$2,779.09
336320	TruckVault Inc.	T-FDEXLM2-07F-TR-HT	Expedition EL Mag 2 Dwr	\$3,740.00	\$3,203.02
336320	TruckVault Inc.	T-FDEXLM2-07F-TR-PP	Ford Expedition EL Mag 2 Dwr, dimensions: 57L x 48W	\$2,985.00	\$2,556.42
336320	TruckVault Inc.	T-FDEXLM2-07M	Ford Expedition EL Mag 2 Dwr, dimensions: 52L x 48W	\$2,985.00	\$2,556.42
336320	TruckVault Inc.	T-FDEXLM2-07M-PP	Ford Expedition EL Mag 2 Dwr, dimensions: 48L x 48W	\$3,045.00	\$2,607.81
336320	TruckVault Inc.	T-FDEXLM2-07M-TR	Expedition EL Mag 2 Dwr	\$2,985.00	\$2,556.42
336320	TruckVault Inc.	T-FDEXLM2-07S	Ford Expedition EL Mag 2 Dwr, dimensions: 27L x 48W	\$2,645.00	\$2,265.24
336320	TruckVault Inc.	T-FDEXLMO-07F	Ford Expedition EL Mag OS Dwr, dimensions: 60L x 48W	\$3,245.00	\$2,779.09
336320	TruckVault Inc.	T-FDEXLMO-07F-HT	Expedition EL Mag OS Dwr	\$3,740.00	\$3,203.02
336320	TruckVault Inc.	T-FDEXLMO-07F-PS	Ford Expedition EL Mag OS Dwr, dimensions: 60L x 48W	\$3,245.00	\$2,779.09
336320	TruckVault Inc.	T-FDEXLMO-07F-PT	Ford Expedition EL Mag OS Dwr, dimensions: 58L x 48W	\$3,740.00	\$3,203.02
336320	TruckVault Inc.	T-FDEXLMO-07F-TR	Ford Expedition EL Mag OS Dwr, dimensions: 60L x 48W	\$3,245.00	\$2,779.09
336320	TruckVault Inc.	T-FDEXLMO-07F-TR-PP	Expedition EL Mag OS Dwr	\$3,045.00	\$2,607.81
336320	TruckVault Inc.	T-FDEXLMO-07M	Ford Expedition EL Mag OS Dwr, dimensions: 52L x 48W	\$2,985.00	\$2,556.42
336320	TruckVault Inc.	T-FDEXLMO-07M-PS	Ford Expedition EL Mag OS Dwr, dimensions: 52L x 48W	\$2,985.00	\$2,556.42
336320	TruckVault Inc.	T-FDEXLMO-07M-PT	Ford Expedition EL Mag OS Dwr, dimensions: 51L x 48W	\$3,740.00	\$3,203.02
336320	TruckVault Inc.	T-FDEXLMO-07M-TR	Ford Expedition EL Mag OS Dwr, dimensions: 52L x 48W	\$2,985.00	\$2,556.42
336320	TruckVault Inc.	T-FDEXLMO-07S	Ford Expedition EL Mag Offset Dwrs, dimensions: 27L x 48W	\$2,645.00	\$2,265.24
336320	TruckVault Inc.	T-FDEXLN1-07N-ZC10064	Expedition EL CustomC10064	\$1,875.00	\$1,605.79
336320	TruckVault Inc.	T-FDEXLS1-07M	Ford Expedition EL Std 1 Dwr, dimensions: 52L x 48W	\$2,215.00	\$1,896.98
336320	TruckVault Inc.	T-FDEXLS1-07S	Ford Expedition EL Std 1 Dwr, dimensions: 28L x 48W	\$1,895.00	\$1,622.92
336320	TruckVault Inc.	T-FDEXLS1-07S-HT	Expedition EL Std 1 Dwr	\$2,590.00	\$2,218.14
336320	TruckVault Inc.	T-FDEXLS2-07F	Ford Expedition EL Std 2 Dwr, dimensions: 61L x 48W	\$2,985.00	\$2,556.42
336320	TruckVault Inc.	T-FDEXLS2-07F-HT	Expedition EL Std 2 Dwr	\$3,540.00	\$3,031.74
336320	TruckVault Inc.	T-FDEXLS2-07F-PP	Ford Expedition EL Std 2 Dwr, dimensions: 58L x 48W	\$2,845.00	\$2,436.52
336320	TruckVault Inc.	T-FDEXLS2-07F-PT	Ford Expedition EL Std 2 Dwr, dimensions: 60L x 48W	\$3,685.00	\$3,155.92
336320	TruckVault Inc.	T-FDEXLS2-07F-TR	Ford Expedition EL Std 2 Dwr, dimensions: 61L x 48W	\$2,985.00	\$2,556.42
336320	TruckVault Inc.	T-FDEXLS2-07F-TR-PP	Ford Expedition EL Std 2 Dwr, dimensions: 58L x 48W	\$2,845.00	\$2,436.52
336320	TruckVault Inc.	T-FDEXLS2-07M	Ford Expedition EL Std 2 Dwr, dimensions: 52L x 48W	\$2,755.00	\$2,359.45
336320	TruckVault Inc.	T-FDEXLS2-07M-PT	Ford Expedition EL Std 2 Dwr, dimensions: 52L x 48W	\$3,465.00	\$2,967.51
336320	TruckVault Inc.	T-FDEXLS2-07M-TR	Ford Expedition EL Std 2 Dwr, dimensions: 52L x 48W	\$2,755.00	\$2,359.45
336320	TruckVault Inc.	T-FDEXLS2-07M-TR-PT	Ford Expedition EL Std 2 Dwr, dimensions: 52L x 48W	\$3,465.00	\$2,967.51
336320	TruckVault Inc.	T-FDEXLS2-07S	Ford Expedition EL Std 2 Dwr, dimensions: 28L x 48W	\$2,445.00	\$2,093.95
336320	TruckVault Inc.	T-FDEXLSO-07F	Ford Expedition EL Std OS Dwr, dimensions: 28L x 48W	\$2,445.00	\$2,093.95
336320	TruckVault Inc.	T-FDEXLSO-07F-TR	Ford Expedition EL Std OS Dwr, dimensions: 61L x 48W	\$2,985.00	\$2,556.42
336320	TruckVault Inc.	T-FDEXLSO-07M	Ford Expedition EL Std OS Dwr, dimensions: 52L x 48W	\$2,755.00	\$2,359.45
336320	TruckVault Inc.	T-FDEXLU2-07F	Expedition EL Utility 2 Dwr	\$3,095.00	\$2,650.63
336320	TruckVault Inc.	T-FDEXLU2-07M-TR	Expedition EL Utility 2 Dwr3rd Row Seat Removed	\$2,765.00	\$2,368.01
336320	TruckVault Inc.	T-FDEXPM1-03N	Ford Expedition Mag 1 Dwr, dimensions: 45L x 48W	\$2,295.00	\$1,965.49
336320	TruckVault Inc.	T-FDEXPM1-03N-BS	Ford Expedition Mag 1 Dwr, dimensions: 46L x 48.625W	\$2,295.00	\$1,965.49
336320	TruckVault Inc.	T-FDEXPM1-03N-HD	Expedition Mag 1 Dwr	\$1,895.00	\$1,622.92
336320	TruckVault Inc.	T-FDEXPM1-03N-HP	Expedition Mag 1 Dwr Half Width	\$1,895.00	\$1,622.92
336320	TruckVault Inc.	T-FDEXPM1-03N-HT	Expedition Mag 1 Dwr	\$2,990.00	\$2,560.71
336320	TruckVault Inc.	T-FDEXPM1-03N-HT-TR	Expedition Mag 1 Dwr	\$2,990.00	\$2,560.71
336320	TruckVault Inc.	T-FDEXPM1-03N-PP	Ford Expedition Mag 1 Dwr, dimensions: 42L x 48W	\$2,295.00	\$1,965.49
336320	TruckVault Inc.	T-FDEXPM1-03N-PP-PT	Ford Expedition Mag 1 Dwr, dimensions: 42L x 48W	\$2,990.00	\$2,560.71
336320	TruckVault Inc.	T-FDEXPM1-03N-PP-TR	Expedition Mag 1 Dwr	\$2,295.00	\$1,965.49
336320	TruckVault Inc.	T-FDEXPM1-03N-PP-ZC10731	Expedition Mag 1 Dwr3rd Seat Folded, P-Cage	\$2,115.00	\$1,811.34
336320	TruckVault Inc.	T-FDEXPM1-03N-PS	Ford Expedition Mag 1 Dwr, dimensions: 45L x 48W	\$2,295.00	\$1,965.49
336320	TruckVault Inc.	T-FDEXPM1-03N-PS-PP	Ford Expedition Mag 1 Dwr, dimensions: 42L x 48W	\$2,295.00	\$1,965.49
336320	TruckVault Inc.	T-FDEXPM1-03N-PS-PT	Ford Expedition Mag 1 Dwr, dimensions: 44L x 48W	\$2,990.00	\$2,560.71
336320	TruckVault Inc.	T-FDEXPM1-03N-PT	Ford Expedition Mag 1 Dwr, dimensions: 44L x 48W	\$2,990.00	\$2,560.71
336320	TruckVault Inc.	T-FDEXPM1-03N-TR	Ford Expedition Mag 1 Dwr, dimensions: 45L x 48W	\$2,295.00	\$1,965.49
336320	TruckVault Inc.	T-FDEXPM1-18N	Expedition Mag 1 Dwr	\$2,295.00	\$1,965.49
336320	TruckVault Inc.	T-FDEXPM1-18N-C1-ZC7810	Expedition Mag 1 Dwr Custom	\$1,575.00	\$1,348.87
336320	TruckVault Inc.	T-FDEXPM1-18N-HD	Expedition Mag 1 Dwr Half Width3rd Row Folded; Drivers Side	\$1,895.00	\$1,622.92
336320	TruckVault Inc.	T-FDEXPM1-18N-HG	Expedition Magnum 1 DrawerElevated Version; No 3rd Row	\$2,045.00	\$1,751.39
336320	TruckVault Inc.	T-FDEXPM1-18N-PP-TR	Expedition Mag 1 Dwr	\$2,295.00	\$1,965.49

336320	TruckVault Inc.	T-FDEXPM1-18N-PT	Expedition Mag 1 Dwr	\$2,990.00	\$2,560.71
336320	TruckVault Inc.	T-FDEXPM1-18N-TR	Expedition Mag 1 Dwr	\$2,295.00	\$1,965.49
336320	TruckVault Inc.	T-FDEXPM1-18N-TR-HD	Expedition Mag 1 Dwr Half Width3rd Row Removed or SSV; Drivers Side	\$1,855.00	\$1,588.66
336320	TruckVault Inc.	T-FDEXPM1-18N-TR-HT	Expedition Mag 1 Dwr HD Table	\$2,990.00	\$2,560.71
336320	TruckVault Inc.	T-FDEXPM1-18S	Expedition Mag 1 Dwr	\$1,895.00	\$1,622.92
336320	TruckVault Inc.	T-FDEXPM1-96N	Ford Expedition Mag 1 Dwr, dimensions: 42.5L x 48W	\$2,295.00	\$1,965.49
336320	TruckVault Inc.	T-FDEXPM1-96N-PA	Ford Expedition Mag 1 Dwr, dimensions: 42.5L x 48W	\$2,295.00	\$1,965.49
336320	TruckVault Inc.	T-FDEXPM1-96N-PP	Ford Expedition Mag 1 Dwr, dimensions: 39.5L x 48W	\$2,295.00	\$1,965.49
336320	TruckVault Inc.	T-FDEXPM1-96N-PT	Ford Expedition Mag 1 Dwr, dimensions: 41.5L x 48W	\$2,990.00	\$2,560.71
336320	TruckVault Inc.	T-FDEXPM2-03N	Ford Expedition Mag 2 Dwr, dimensions: 45L x 48W	\$2,845.00	\$2,436.52
336320	TruckVault Inc.	T-FDEXPM2-03N-BS	Ford Expedition Mag 2 Dwr, dimensions: 46L x 48.625W	\$2,845.00	\$2,436.52
336320	TruckVault Inc.	T-FDEXPM2-03N-HT	Expedition Mag 2 Dwr	\$3,540.00	\$3,031.74
336320	TruckVault Inc.	T-FDEXPM2-03N-PP	Ford Expedition Mag 2 Dwr, dimensions: 42L x 48W	\$2,845.00	\$2,436.52
336320	TruckVault Inc.	T-FDEXPM2-03N-PS	Ford Expedition Mag 2 Dwr, dimensions: 45L x 48W	\$2,845.00	\$2,436.52
336320	TruckVault Inc.	T-FDEXPM2-03N-PS-PP	Ford Expedition Mag 2 Dwr, dimensions: 42L x 48W	\$2,845.00	\$2,436.52
336320	TruckVault Inc.	T-FDEXPM2-03N-PS-PP-PT	Ford Expedition Mag 2 Dwr, dimensions: 41L x 48W	\$3,540.00	\$3,031.74
336320	TruckVault Inc.	T-FDEXPM2-03N-PS-PT	Ford Expedition Mag 2 Dwr, dimensions: 44L x 48W	\$3,540.00	\$3,031.74
336320	TruckVault Inc.	T-FDEXPM2-03N-PT	Ford Expedition Mag 2 Dwr, dimensions: 44L x 48W	\$3,540.00	\$3,031.74
336320	TruckVault Inc.	T-FDEXPM2-03N-TR	Ford Expedition Mag 2 Dwr, dimensions: 45L x 48W	\$2,845.00	\$2,436.52
336320	TruckVault Inc.	T-FDEXPM2-03N-TR-HT	Expedition Mag 2 Dwr	\$3,540.00	\$3,031.74
336320	TruckVault Inc.	T-FDEXPM2-03N-TR-PP	Ford Expedition Mag 2 Dwr, dimensions: 42L x 48W	\$2,845.00	\$2,436.52
336320	TruckVault Inc.	T-FDEXPM2-03N-TR-PP-PT	Ford Expedition Mag 2 Dwr, Tbl Ex, dimensions: 41L x 48W	\$3,540.00	\$3,031.74
336320	TruckVault Inc.	T-FDEXPM2-03N-TR-PT	Ford Expedition Mag 2 Dwr, dimensions: 44L x 48W	\$3,540.00	\$3,031.74
336320	TruckVault Inc.	T-FDEXPM2-03N-TT-ZC8155	Expedition Mag 2 Dwr	\$4,055.00	\$3,472.80
336320	TruckVault Inc.	T-FDEXPM2-18N	Expedition Mag 2 Dwr	\$2,845.00	\$2,436.52
336320	TruckVault Inc.	T-FDEXPM2-18N-PP-TR	Expedition Mag 2 Dwr	\$2,845.00	\$2,436.52
336320	TruckVault Inc.	T-FDEXPM2-18N-TR	Expedition Mag 2 Dwr	\$2,845.00	\$2,436.52
336320	TruckVault Inc.	T-FDEXPM2-18N-TR-HT	Expedition Mag 2 Dwr	\$3,540.00	\$3,031.74
336320	TruckVault Inc.	T-FDEXPM2-18N-TT	Expedition Mag 2 Dwr3rd Row Folded; Top Tray	\$3,745.00	\$3,207.30
336320	TruckVault Inc.	T-FDEXPM2-18N-TT-ZC10194	Expedition Mag 2 Dwr Dual Top Trays3rd Row Folded	\$4,525.00	\$3,875.31
336320	TruckVault Inc.	T-FDEXPM2-18S	Expedition Mag 2 DwrS-Size, Behind 3rd Row Seats	\$2,445.00	\$2,093.95
336320	TruckVault Inc.	T-FDEXPM2-96N	Ford Expedition Mag 2 Dwr, dimensions: 42.5L x 48W	\$2,845.00	\$2,436.52
336320	TruckVault Inc.	T-FDEXPM2-96N-PA	Ford Expedition Mag 2 Dwr, dimensions: 42.5L x 48W	\$2,845.00	\$2,436.52
336320	TruckVault Inc.	T-FDEXPM2-96N-PP	Ford Expedition Mag 2 Dwr, dimensions: 39.5L x 48W	\$2,845.00	\$2,436.52
336320	TruckVault Inc.	T-FDEXPM2-96N-PP-PA	Ford Expedition Mag 2 Dwr, dimensions: 39.5L x 48W	\$2,845.00	\$2,436.52
336320	TruckVault Inc.	T-FDEXPML-96N	Ford Expedition Mag L Dwr, dimensions: 42.5L x 52W	\$2,225.00	\$1,905.54
336320	TruckVault Inc.	T-FDEXPMO-03N	Ford Expedition Mag OS Dwr, dimensions: 45L x 48W	\$2,845.00	\$2,436.52
336320	TruckVault Inc.	T-FDEXPMO-03N-PP	Ford Expedition Mag OS Dwr, dimensions: 42L x 48W	\$2,845.00	\$2,436.52
336320	TruckVault Inc.	T-FDEXPMO-03N-PP-HT	Expedition Mag Offset Dwr	\$3,540.00	\$3,031.74
336320	TruckVault Inc.	T-FDEXPMO-03N-PP-PT	Ford Expedition Mag OS Dwr, dimensions: 44L x 48W	\$3,540.00	\$3,031.74
336320	TruckVault Inc.	T-FDEXPMO-03N-PS	Ford Expedition Mag OS Dwr, dimensions: 45L x 48W	\$2,845.00	\$2,436.52
336320	TruckVault Inc.	T-FDEXPMO-03N-PS-PP	Ford Expedition Mag OS Dwr, dimensions: 42L x 48W	\$2,845.00	\$2,436.52
336320	TruckVault Inc.	T-FDEXPMO-03N-PS-PT	Ford Expedition Mag OS Dwr, dimensions: 44L x 48W	\$3,540.00	\$3,031.74
336320	TruckVault Inc.	T-FDEXPMO-03N-PT	Ford Expedition Mag OS Dwr, dimensions: 44L x 48W	\$3,540.00	\$3,031.74
336320	TruckVault Inc.	T-FDEXPMO-03N-TR	Ford Expedition Mag OS Dwr, dimensions: 45L x 48W	\$2,845.00	\$2,436.52
336320	TruckVault Inc.	T-FDEXPMO-03N-TR-PP	Ford Expedition Mag OS Dwr, dimensions: 42L x 48W	\$2,845.00	\$2,436.52
336320	TruckVault Inc.	T-FDEXPMO-18N	Expedition Mag OS Dwr	\$2,845.00	\$2,436.52
336320	TruckVault Inc.	T-FDEXPMO-18N-PP-TR	Expedition Mag OS Dwr	\$2,845.00	\$2,436.52
336320	TruckVault Inc.	T-FDEXPMO-18N-TR	Expedition Mag OS Dwr	\$2,845.00	\$2,436.52
336320	TruckVault Inc.	T-FDEXPMO-18N-TR-PP-ZC10041	Expedition Custom 1 Dwr	\$2,485.00	\$2,128.21
336320	TruckVault Inc.	T-FDEXPMO-18N-TR-ZC10041	Expedition Mag OS DwrC10041	\$2,605.00	\$2,230.98
336320	TruckVault Inc.	T-FDEXPMO-96N	Ford Expedition Mag OS Dwr, dimensions: 42.5L x 48W	\$2,845.00	\$2,436.52
336320	TruckVault Inc.	T-FDEXPMO-96N-PA	Ford Expedition Mag OS Dwr, dimensions: 30.125L x 48W	\$2,645.00	\$2,265.24
336320	TruckVault Inc.	T-FDEXPMO-96N-PT	Ford Expedition Mag OS Dwr, dimensions: 30.125L x 48W	\$3,340.00	\$2,860.45
336320	TruckVault Inc.	T-FDEXPMT-96N	Ford Expedition Mag T Dwr, dimensions: 42.5L x 56W	\$2,295.00	\$1,965.49
336320	TruckVault Inc.	T-FDEXPN0-18N-TR-C3-ZC10667D	Expedition Custom Design	\$2,055.00	\$1,759.95
336320	TruckVault Inc.	T-FDEXPN1-03N-ZC10579	Expedition Cust 1 DwrC10579	\$1,905.00	\$1,631.49
336320	TruckVault Inc.	T-FDEXPN1-03N-ZC7457	Expedition CUST 1 Dwr	\$2,365.00	\$2,025.44
336320	TruckVault Inc.	T-FDEXPN1-18N-TR-C1-HT-ZC10445	Expedition Cust 1 Dwr	\$1,905.00	\$1,631.49
336320	TruckVault Inc.	T-FDEXPN1-18N-TR-ZC10580	Expedition Cust 1 DwrC10580	\$1,905.00	\$1,631.49
336320	TruckVault Inc.	T-FDEXPN1-18N-ZC10580	Expedition Cust 1 DwrC10580	\$1,905.00	\$1,631.49
336320	TruckVault Inc.	T-FDEXPN1-18N-ZC8145	Expedition CUST 1 Dwr	\$2,485.00	\$2,128.21
336320	TruckVault Inc.	T-FDEXPN1-18N-ZC8283	Expedition CUST 1 Dwr	\$2,705.00	\$2,316.62
336320	TruckVault Inc.	T-FDEXPN1-18N-ZC9159	Expedition CUST 1 Dwr	\$2,725.00	\$2,333.75
336320	TruckVault Inc.	T-FDEXPN2-18N-TR-HT-ZC11459	Expedition Custom 2 Dwr	\$3,695.00	\$3,164.48
336320	TruckVault Inc.	T-FDEXPN2-18N-TR-ZC11016B	Expedition Custom 2 DwrC11016B	\$2,955.00	\$2,530.73
336320	TruckVault Inc.	T-FDEXPNO-18N-PP-TR-ZC8888	Expedition Custom Offset Dwr	\$3,055.00	\$2,616.37
336320	TruckVault Inc.	T-FDEXPS1-03N	Ford Expedition Std 1 Dwr, dimensions: 47L x 48W	\$2,095.00	\$1,794.21
336320	TruckVault Inc.	T-FDEXPS1-03N-BS	Ford Expedition Std 1 Dwr, dimensions: 47L x 48.625W	\$2,095.00	\$1,794.21

336320	TruckVault Inc.	T-FDEXPS1-03N-HP	Expedition Std 1 Dwr 1/2 Width PassengerFold 3rd Seat, or 07+	\$1,695.00	\$1,451.64
336320	TruckVault Inc.	T-FDEXPS1-03N-HT	Ford Expedition Std 1 Dwr, dimensions: 45L x 48W	\$2,790.00	\$2,389.42
336320	TruckVault Inc.	T-FDEXPS1-03N-PP	Ford Expedition Std 1 Dwr, dimensions: 44L x 48W	\$2,095.00	\$1,794.21
336320	TruckVault Inc.	T-FDEXPS1-03N-PS	Ford Expedition Std 1 Dwr, dimensions: 47L x 48W	\$2,095.00	\$1,794.21
336320	TruckVault Inc.	T-FDEXPS1-03N-PS-PP	Ford Expedition Std 1 Dwr, dimensions: 44L x 48W	\$2,095.00	\$1,794.21
336320	TruckVault Inc.	T-FDEXPS1-03N-PS-PT	Ford Expedition Std 1 Dwr, dimensions: 46L x 48W	\$2,790.00	\$2,389.42
336320	TruckVault Inc.	T-FDEXPS1-03N-PT	Ford Expedition Std 1 Dwr, dimensions: 46L x 48W	\$2,790.00	\$2,389.42
336320	TruckVault Inc.	T-FDEXPS1-03N-TR	Ford Expedition Std 1 Dwr, dimensions: 47L x 48W	\$2,095.00	\$1,794.21
336320	TruckVault Inc.	T-FDEXPS1-03N-TR-PP	Ford Expedition Std 1 Dwr, dimensions: 44L x 48W	\$2,095.00	\$1,794.21
336320	TruckVault Inc.	T-FDEXPS1-18N	Expedition Std 1 Dwr	\$2,095.00	\$1,794.21
336320	TruckVault Inc.	T-FDEXPS1-18N-PP-TR	Expedition Std 1 Dwr	\$2,095.00	\$1,794.21
336320	TruckVault Inc.	T-FDEXPS1-18N-TR	Expedition Std 1 Dwr	\$2,095.00	\$1,794.21
336320	TruckVault Inc.	T-FDEXPS1-18S	Expedition Std 1 Dwr	\$1,695.00	\$1,451.64
336320	TruckVault Inc.	T-FDEXPS1-96N	Ford Expedition Std 1 Dwr, dimensions: 44L x 48W	\$2,095.00	\$1,794.21
336320	TruckVault Inc.	T-FDEXPS1-96N-PA	Ford Expedition Std 1 Dwr, dimensions: 44L x 48W	\$2,095.00	\$1,794.21
336320	TruckVault Inc.	T-FDEXPS2-03N	Ford Expedition Std 2 Dwr, dimensions: 47L x 48W	\$2,645.00	\$2,265.24
336320	TruckVault Inc.	T-FDEXPS2-03N-BS	Ford Expedition Std 2 Dwr, dimensions: 47L x 48.625W	\$2,645.00	\$2,265.24
336320	TruckVault Inc.	T-FDEXPS2-03N-HT	Expedition Std 2 Dwr	\$3,340.00	\$2,860.45
336320	TruckVault Inc.	T-FDEXPS2-03N-PP	Ford Expedition Std 2 Dwr, dimensions: 44L x 48W	\$2,645.00	\$2,265.24
336320	TruckVault Inc.	T-FDEXPS2-03N-PP-PT	Ford Expedition Std 2 Dwr, dimensions: 43L x 48W	\$3,340.00	\$2,860.45
336320	TruckVault Inc.	T-FDEXPS2-03N-PS	Ford Expedition Std 2 Dwr, dimensions: 46L x 48W	\$2,645.00	\$2,265.24
336320	TruckVault Inc.	T-FDEXPS2-03N-PS-PP	Ford Expedition Std 2 Dwr, dimensions: 44L x 48W	\$2,645.00	\$2,265.24
336320	TruckVault Inc.	T-FDEXPS2-03N-PS-PT	Ford Expedition Std 2 Dwr, dimensions: 46L x 48W	\$3,340.00	\$2,860.45
336320	TruckVault Inc.	T-FDEXPS2-03N-PT	Ford Expedition Std 2 Dwr, dimensions: 46L x 48W	\$3,340.00	\$2,860.45
336320	TruckVault Inc.	T-FDEXPS2-03N-TR	Ford Expedition Std 2 Dwr, dimensions: 47L x 48W	\$2,645.00	\$2,265.24
336320	TruckVault Inc.	T-FDEXPS2-03N-TR-HT	Expedition Std 2 Dwr3rd Row Seat Removed; Heavy Duty Table	\$3,340.00	\$2,860.45
336320	TruckVault Inc.	T-FDEXPS2-03N-TR-PP	Ford Expedition Std 2 Dwr, dimensions: 44L x 48W	\$2,645.00	\$2,265.24
336320	TruckVault Inc.	T-FDEXPS2-18N	Expedition Std 2 Dwr	\$2,645.00	\$2,265.24
336320	TruckVault Inc.	T-FDEXPS2-18N-PP-TR	Expedition Std 2 Dwr	\$2,645.00	\$2,265.24
336320	TruckVault Inc.	T-FDEXPS2-18N-PP-TR-ZC8775	Expedition Std 2 Dwr	\$2,585.00	\$2,213.85
336320	TruckVault Inc.	T-FDEXPS2-18N-TR	Expedition Std 2 Dwr	\$2,645.00	\$2,265.24
336320	TruckVault Inc.	T-FDEXPS2-18N-TT	Expedition Std 2 Dwr Top Tray3rd Row Seat Folded	\$3,525.00	\$3,018.89
336320	TruckVault Inc.	T-FDEXPS2-96N	Ford Expedition Std 2 Dwr, dimensions: 44L x 48W	\$2,645.00	\$2,265.24
336320	TruckVault Inc.	T-FDEXPS2-96N-PA	Ford Expedition Std 2 Dwr, dimensions: 44L x 48W	\$2,645.00	\$2,265.24
336320	TruckVault Inc.	T-FDEXPS2-96N-PA-PT	Ford Expedition Std 2 Dwr, dimensions: 43L x 48W	\$3,340.00	\$2,860.45
336320	TruckVault Inc.	T-FDEXPS2-96N-PP	Ford Expedition Std 2 Dwr, dimensions: 41L x 48W	\$2,645.00	\$2,265.24
336320	TruckVault Inc.	T-FDEXPS2-96N-PT	Ford Expedition Std 2 Dwr, dimensions: 43L x 48W	\$3,340.00	\$2,860.45
336320	TruckVault Inc.	T-FDEXPSL-96N	Ford Expedition Std L Dwr, dimensions: 44L x 52W	\$2,025.00	\$1,734.26
336320	TruckVault Inc.	T-FDEXPSO-03N	Ford Expedition Std OS Dwr, dimensions: 47L x 48W	\$2,645.00	\$2,265.24
336320	TruckVault Inc.	T-FDEXPSO-03N-HT	Expedition Std OS Dwr	\$3,340.00	\$2,860.45
336320	TruckVault Inc.	T-FDEXPSO-03N-PP	Ford Expedition Std OS Dwr, dimensions: 44L x 48W	\$2,645.00	\$2,265.24
336320	TruckVault Inc.	T-FDEXPSO-03N-PP-PT	Ford Expedition Std OS Dwr, dimensions: 43L x 48W	\$3,340.00	\$2,860.45
336320	TruckVault Inc.	T-FDEXPSO-03N-PS	Ford Expedition Std OS Dwr, dimensions: 47L x 48W	\$2,645.00	\$2,265.24
336320	TruckVault Inc.	T-FDEXPSO-03N-PS-PP	Ford Expedition Std OS Dwr, dimensions: 44L x 48W	\$2,645.00	\$2,265.24
336320	TruckVault Inc.	T-FDEXPSO-03N-PS-PT	Ford Expedition Std OS Dwr, dimensions: 43L x 48W	\$3,340.00	\$2,860.45
336320	TruckVault Inc.	T-FDEXPSO-03N-PT	Ford Expedition Std OS Dwr, dimensions: 46L x 48W	\$3,340.00	\$2,860.45
336320	TruckVault Inc.	T-FDEXPSO-03N-TR	Ford Expedition Std OS Dwr, dimensions: 47L x 48W	\$2,645.00	\$2,265.24
336320	TruckVault Inc.	T-FDEXPSO-03N-TR-PP	Ford Expedition Std OS Dwr, dimensions: 44L x 48W	\$2,645.00	\$2,265.24
336320	TruckVault Inc.	T-FDEXPSO-03N-TR-PT	Ford Expedition Std OS Dwr, dimensions: 46L x 48W	\$3,340.00	\$2,860.45
336320	TruckVault Inc.	T-FDEXPSO-18N	Expedition Std OS Dwr	\$2,645.00	\$2,265.24
336320	TruckVault Inc.	T-FDEXPSO-18N-PP-TR	Expedition Std OS Dwr	\$2,645.00	\$2,265.24
336320	TruckVault Inc.	T-FDEXPSO-18N-TR	Expedition Std OS Dwr	\$2,645.00	\$2,265.24
336320	TruckVault Inc.	T-FDEXPSO-96N	Ford Expedition Std OS Dwr, dimensions: 44L x 48W	\$2,645.00	\$2,265.24
336320	TruckVault Inc.	T-FDEXPSO-96N-PA	Ford Expedition Std OS Dwr, dimensions: 44L x 48W	\$2,645.00	\$2,265.24
336320	TruckVault Inc.	T-FDEXPSO-96N-PT	Ford Expedition Std OS Dwr, dimensions: 43L x 48W	\$3,340.00	\$2,860.45
336320	TruckVault Inc.	T-FDEXPST-96N	Ford Expedition Std T Dwr, dimensions: 44L x 56W	\$2,095.00	\$1,794.21
336320	TruckVault Inc.	T-FDEXPU1-03N	Expedition Utility 1 Dwr	\$2,195.00	\$1,879.85
336320	TruckVault Inc.	T-FDEXPU1-03N-TR	Expedition Utility 1 Dwr	\$2,195.00	\$1,879.85
336320	TruckVault Inc.	T-FDEXPU1-18N	Expedition Utility 1 Dwr	\$2,125.00	\$1,819.90
336320	TruckVault Inc.	T-FDEXPU1-18N-TR	Expedition Utility 1 Dwr	\$2,195.00	\$1,879.85
336320	TruckVault Inc.	T-FDEXPU1-18N-TR-PP	Expedition Utility 1 Dwr Cage	\$2,195.00	\$1,879.85
336320	TruckVault Inc.	T-FDEXPU1-18S	Expedition Utility 1 Dwr	\$1,795.00	\$1,537.28
336320	TruckVault Inc.	T-FDEXPU2-03N	Expedition Utility 2 Dwr	\$2,745.00	\$2,350.88
336320	TruckVault Inc.	T-FDEXPU2-03N-TR	Expedition Utility 2 Dwr	\$2,745.00	\$2,350.88
336320	TruckVault Inc.	T-FDEXPU2-18N	Expedition Utility 2 Dwr	\$2,745.00	\$2,350.88
336320	TruckVault Inc.	T-FDEXPU2-18N-TR	Expedition Utility 2 Dwr	\$2,745.00	\$2,350.88
336320	TruckVault Inc.	T-FDEXPU2-18N-TR-PP	Expedition Utility 2 Dwr	\$2,745.00	\$2,350.88
336320	TruckVault Inc.	T-FDEXPUO-03N-PP	Expedition Utility Offset Dwr	\$2,745.00	\$2,350.88

336320	TruckVault Inc.	T-FDEXPUO-03N-TR-HT	Expedition Utility Offset Dwr3rd Row Seat Removed; Heavy Duty Table	\$3,440.00	\$2,946.10
336320	TruckVault Inc.	T-FDEXPUO-03N-TR-PP	Expedition Utility 2 Dwr Offset	\$2,745.00	\$2,350.88
336320	TruckVault Inc.	T-FDEXPUO-18N	Expedition Utility Offset Dwr3rd Row Seat Folded	\$2,745.00	\$2,350.88
336320	TruckVault Inc.	T-FDEXPUO-18N-TR	Expedition Utility OS Dwr	\$2,745.00	\$2,350.88
336320	TruckVault Inc.	T-FDEXRM1-02N	Ford Explorer Mag 1 Dwr, dimensions: 40L x 44.5W	\$2,295.00	\$1,965.49
336320	TruckVault Inc.	T-FDEXRM1-02N-HT	Ford Explorer Mag 1 Dwr, dimensions: 40L x 44.5W	\$2,990.00	\$2,560.71
336320	TruckVault Inc.	T-FDEXRM1-02N-PP	Ford Explorer Mag 1 Dwr, dimensions: 37L x 44.5W	\$2,295.00	\$1,965.49
336320	TruckVault Inc.	T-FDEXRM1-02N-PT	Ford Explorer Mag 1 Dwr, dimensions: 39L x 44.5W	\$2,990.00	\$2,560.71
336320	TruckVault Inc.	T-FDEXRM1-06N	Ford Explorer Mag 1 Dwr, dimensions: 38.5L x 44.5W	\$2,295.00	\$1,965.49
336320	TruckVault Inc.	T-FDEXRM1-06N-PP	Ford Explorer Mag 1 Dwr, dimensions: 35.5L x 44.5W	\$2,095.00	\$1,794.21
336320	TruckVault Inc.	T-FDEXRM1-06N-PT	Ford Explorer Mag 1 Dwr, dimensions: 37.5L x 44.5W	\$2,990.00	\$2,560.71
336320	TruckVault Inc.	T-FDEXRM1-06N-T3	Ford Explorer Mag 1 Dwr, dimensions: 36.5L x 44.5W	\$2,295.00	\$1,965.49
336320	TruckVault Inc.	T-FDEXRM1-11N	Ford Explorer Mag 1 Dwr, dimensions: 41L x 40W	\$2,295.00	\$1,965.49
336320	TruckVault Inc.	T-FDEXRM1-11N-HG	Explorer Magnum 1 Drawer	\$1,965.00	\$1,682.87
336320	TruckVault Inc.	T-FDEXRM1-11N-HT	Ford Explorer Mag 1 Dwr, dimensions: 38L x 40W	\$2,990.00	\$2,560.71
336320	TruckVault Inc.	T-FDEXRM1-11N-LT	Ford Explorer Mag 1 Dwr, dimensions: 41L x 40W	\$2,990.00	\$2,560.71
336320	TruckVault Inc.	T-FDEXRM1-11N-PP	Ford Explorer Mag 1 Dwr, dimensions: 38L x 40W	\$2,295.00	\$1,965.49
336320	TruckVault Inc.	T-FDEXRM1-11N-PP-LT	Ford Explorer Mag 1 Dwr, dimensions: 36L x 40W	\$2,990.00	\$2,560.71
336320	TruckVault Inc.	T-FDEXRM1-11N-PS	Ford Explorer Mag 1 Dwr, dimensions: 41L x 40W	\$2,295.00	\$1,965.49
336320	TruckVault Inc.	T-FDEXRM1-11N-PS-HG	Explorer Magnum 1 Drawer	\$1,965.00	\$1,682.87
336320	TruckVault Inc.	T-FDEXRM1-11N-PS-HT	Explorer Mag 1 Dwr	\$2,990.00	\$2,560.71
336320	TruckVault Inc.	T-FDEXRM1-11N-PS-LT	Ford Explorer Mag 1 Dwr, dimensions: 41L x 40W	\$2,890.00	\$2,475.06
336320	TruckVault Inc.	T-FDEXRM1-11N-PS-P7	Explorer Mag 1 Dwr	\$2,095.00	\$1,794.21
336320	TruckVault Inc.	T-FDEXRM1-11N-PS-PP	Ford Explorer Mag 1 Dwr, dimensions: 38L x 40W	\$2,295.00	\$1,965.49
336320	TruckVault Inc.	T-FDEXRM1-11N-PS-PP-HT	Explorer Mag 1 Dwr	\$2,990.00	\$2,560.71
336320	TruckVault Inc.	T-FDEXRM1-11N-PS-PP-LT	Ford Explorer Mag 1 Dwr, dimensions: 36L x 40W	\$2,890.00	\$2,475.06
336320	TruckVault Inc.	T-FDEXRM1-11N-PS-PP-PT	Ford Explorer Mag 1 Dwr, dimensions: 37L x 40W	\$2,990.00	\$2,560.71
336320	TruckVault Inc.	T-FDEXRM1-11N-PS-PP-TT	Explorer Mag 1 Dwr	\$3,195.00	\$2,736.27
336320	TruckVault Inc.	T-FDEXRM1-11N-PS-PP-TT-ZC8254	Explorer Mag 1 Dwr	\$3,275.00	\$2,804.79
336320	TruckVault Inc.	T-FDEXRM1-11N-PS-PT	Ford Explorer Mag 1 Dwr, dimensions: 40L x 40W	\$2,990.00	\$2,560.71
336320	TruckVault Inc.	T-FDEXRM1-11N-PS-SA	Ford Explorer Mag 1 Dwr, dimensions: 28L x 40W	\$2,095.00	\$1,794.21
336320	TruckVault Inc.	T-FDEXRM1-11N-PS-SA-P7	Ford Explorer Mag 1 Dwr, dimensions: 21L x 40W	\$1,895.00	\$1,622.92
336320	TruckVault Inc.	T-FDEXRM1-11N-PS-SA-PP	Ford Explorer Mag 1 Dwr, dimensions: 25L x 40W	\$2,095.00	\$1,794.21
336320	TruckVault Inc.	T-FDEXRM1-11N-PS-TT	Explorer Mag 1 Dwr	\$3,195.00	\$2,736.27
336320	TruckVault Inc.	T-FDEXRM1-11N-PT	Ford Explorer Mag 1 Dwr, dimensions: 40L x 40W	\$2,990.00	\$2,560.71
336320	TruckVault Inc.	T-FDEXRM1-11N-SA	Ford Explorer Mag 1 Dwr, dimensions: 32L x 40W	\$2,095.00	\$1,794.21
336320	TruckVault Inc.	T-FDEXRM1-11N-SA-PP	Ford Explorer Mag 1 Dwr, dimensions: 29L x 40W	\$2,095.00	\$1,794.21
336320	TruckVault Inc.	T-FDEXRM1-20N	Explorer Mag 1 Dwr	\$2,295.00	\$1,965.49
336320	TruckVault Inc.	T-FDEXRM1-20N-HG	Explorer Magnum 1 Drawer	\$1,965.00	\$1,682.87
336320	TruckVault Inc.	T-FDEXRM1-20N-HT	Explorer Mag 1 Dwr3rd Seat Folded HD Table	\$2,990.00	\$2,560.71
336320	TruckVault Inc.	T-FDEXRM1-20N-HT-LT	Explorer Mag 1 DwrLift, HD Table	\$3,790.00	\$3,245.84
336320	TruckVault Inc.	T-FDEXRM1-20N-LT	Explorer Mag 1 Dwr	\$3,095.00	\$2,650.63
336320	TruckVault Inc.	T-FDEXRM1-20N-PP-LT	Explorer Mag 1 DwrLift	\$3,095.00	\$2,650.63
336320	TruckVault Inc.	T-FDEXRM1-20N-PS	Explorer Mag 1 Dwr	\$2,295.00	\$1,965.49
336320	TruckVault Inc.	T-FDEXRM1-20N-PS-C1-LT-ZC9642	Explorer Mag 1 Dwr	\$2,415.00	\$2,068.26
336320	TruckVault Inc.	T-FDEXRM1-20N-PS-C2-LT-ZC10758	Explorer CustomC10758	\$2,535.00	\$2,171.03
336320	TruckVault Inc.	T-FDEXRM1-20N-PS-HG	Explorer Magnum 1 Drawer	\$2,045.00	\$1,751.39
336320	TruckVault Inc.	T-FDEXRM1-20N-PS-K9	Explorer Mag 1 Dwr	\$2,095.00	\$1,794.21
336320	TruckVault Inc.	T-FDEXRM1-20N-PS-LT	Explorer Mag 1 Dwr	\$3,095.00	\$2,650.63
336320	TruckVault Inc.	T-FDEXRM1-20N-PS-P7	Explorer Mag 1 DwrPolice Package; 7" Shorten	\$2,095.00	\$1,794.21
336320	TruckVault Inc.	T-FDEXRM1-20N-PS-PP	Explorer Mag 1 Dwr	\$2,295.00	\$1,965.49
336320	TruckVault Inc.	T-FDEXRM1-20N-PS-PP-HT	Explorer Mag 1 Dwr	\$2,990.00	\$2,560.71
336320	TruckVault Inc.	T-FDEXRM1-20N-PS-PP-LR	Explorer Magnum 1 DwrPolice Package; Prisoner Cage; Radio Lift & Tray	\$3,095.00	\$2,650.63
336320	TruckVault Inc.	T-FDEXRM1-20N-PS-PP-LT	Explorer Mag 1 Dwr	\$3,095.00	\$2,650.63
336320	TruckVault Inc.	T-FDEXRM1-20N-PS-PT-ZC10872A	Explorer Mag 1 Dwr CustomC10872A	\$2,705.00	\$2,316.62
336320	TruckVault Inc.	T-FDEXRM1-20N-PS-RD-HG	Explorer Magnum 1 DrawerElevated Version; Radio Drawer; Police Package	\$2,495.00	\$2,136.78
336320	TruckVault Inc.	T-FDEXRM1-20N-PS-SA	Explorer Mag 1 Dwr	\$2,095.00	\$1,794.21
336320	TruckVault Inc.	T-FDEXRM1-20N-PS-SA-PP	Explorer Mag 1 Dwr	\$1,895.00	\$1,622.92
336320	TruckVault Inc.	T-FDEXRM1-20N-PS-Z1	Explorer Mag 1 Dwr	\$2,325.00	\$1,991.18
336320	TruckVault Inc.	T-FDEXRM1-20N-SA	Explorer Mag 1 Dwr	\$2,095.00	\$1,794.21
336320	TruckVault Inc.	T-FDEXRM1-20N-TR-C1-ZC11089	Explorer Mag 1 Dwr CustomC11089	\$2,035.00	\$1,742.82
336320	TruckVault Inc.	T-FDEXRM1-20S	Explorer Mag 1 Dwr	\$1,895.00	\$1,622.92
336320	TruckVault Inc.	T-FDEXRM2-02N	Ford Explorer Mag 2 Dwr, dimensions: 40L x 44.5W	\$2,845.00	\$2,436.52
336320	TruckVault Inc.	T-FDEXRM2-02N-PP	Ford Explorer Mag 2 Dwr, dimensions: 37L x 44.5W	\$2,845.00	\$2,436.52
336320	TruckVault Inc.	T-FDEXRM2-06N	Ford Explorer Mag 2 Dwr, dimensions: 38.5L x 44.5W	\$2,845.00	\$2,436.52

336320	TruckVault Inc.	T-FDEXRM2-06N-PP	Ford Explorer Mag 2 Dwr, dimensions: 35.5L x 44.5W	\$2,645.00	\$2,265.24
336320	TruckVault Inc.	T-FDEXRM2-06N-PT	Ford Explorer Mag 2 Dwr, dimensions: 37.5L x 44.5W	\$3,540.00	\$3,031.74
336320	TruckVault Inc.	T-FDEXRM2-11N	Ford Explorer Mag 2 Dwr, dimensions: 41L x 40W	\$2,845.00	\$2,436.52
336320	TruckVault Inc.	T-FDEXRM2-11N-HT	Explorer Mag 2 Dwr	\$3,540.00	\$3,031.74
336320	TruckVault Inc.	T-FDEXRM2-11N-LT	Ford Explorer Mag 2 Dwr, dimensions: 41L x 40W	\$3,540.00	\$3,031.74
336320	TruckVault Inc.	T-FDEXRM2-11N-PP	Ford Explorer Mag 2 Dwr, dimensions: 38L x 40W	\$2,845.00	\$2,436.52
336320	TruckVault Inc.	T-FDEXRM2-11N-PP-LT	Ford Explorer Mag 2 Dwr, dimensions: 36L x 40W	\$3,540.00	\$3,031.74
336320	TruckVault Inc.	T-FDEXRM2-11N-PS	Ford Explorer Mag 2 Dwr, dimensions: 41L x 40W	\$2,845.00	\$2,436.52
336320	TruckVault Inc.	T-FDEXRM2-11N-PS-HT	Explorer Mag 2 Dwr	\$3,540.00	\$3,031.74
336320	TruckVault Inc.	T-FDEXRM2-11N-PS-LT	Ford Explorer Mag 2 Dwr, dimensions: 41L x 40W	\$3,440.00	\$2,946.10
336320	TruckVault Inc.	T-FDEXRM2-11N-PS-P7	Ford Explorer Mag 2 Dwr, dimensions: 34L x 40W	\$2,645.00	\$2,265.24
336320	TruckVault Inc.	T-FDEXRM2-11N-PS-P7-PT	Ford Explorer Mag 2 Dwr, dimensions: 34L x 40W	\$3,340.00	\$2,860.45
336320	TruckVault Inc.	T-FDEXRM2-11N-PS-PP	Ford Explorer Mag 2 Dwr, dimensions: 38L x 40W	\$2,845.00	\$2,436.52
336320	TruckVault Inc.	T-FDEXRM2-11N-PS-PP-HT	Explorer Mag 2 Dwr, P-Cage	\$3,340.00	\$2,860.45
336320	TruckVault Inc.	T-FDEXRM2-11N-PS-PP-LT	Ford Explorer Mag 2 Dwr, dimensions: 36L x 40W	\$3,440.00	\$2,946.10
336320	TruckVault Inc.	T-FDEXRM2-11N-PS-PP-PT	Ford Explorer Mag 2 Dwr, dimensions: 38L x 40W	\$3,540.00	\$3,031.74
336320	TruckVault Inc.	T-FDEXRM2-11N-PS-PP-SA	Ford Explorer Mag 2 Dwr, dimensions: 25L x 40W	\$2,645.00	\$2,265.24
336320	TruckVault Inc.	T-FDEXRM2-11N-PS-PP-ZC9371	Explorer Mag 2 Dwr	\$2,815.00	\$2,410.83
336320	TruckVault Inc.	T-FDEXRM2-11N-PS-SA	Ford Explorer Mag 2 Dwr, dimensions: 28L x 40W	\$2,645.00	\$2,265.24
336320	TruckVault Inc.	T-FDEXRM2-11N-PS-SA-P7	Ford Explorer Mag 2 Dwr, dimensions: 32L x 40W	\$2,645.00	\$2,265.24
336320	TruckVault Inc.	T-FDEXRM2-11N-PT	Ford Explorer Mag 2 Dwr, dimensions: 40L x 40W	\$3,540.00	\$3,031.74
336320	TruckVault Inc.	T-FDEXRM2-11N-SA	Ford Explorer Mag 2 Dwr, dimensions: 32L x 40W	\$2,645.00	\$2,265.24
336320	TruckVault Inc.	T-FDEXRM2-20N	Explorer Mag 2 Dwr	\$2,845.00	\$2,436.52
336320	TruckVault Inc.	T-FDEXRM2-20N-HT	Explorer Mag 2 Dwr	\$3,540.00	\$3,031.74
336320	TruckVault Inc.	T-FDEXRM2-20N-LT	Explorer Mag 2 Dwr	\$3,645.00	\$3,121.66
336320	TruckVault Inc.	T-FDEXRM2-20N-PS	Explorer Mag 2 Dwr	\$2,845.00	\$2,436.52
336320	TruckVault Inc.	T-FDEXRM2-20N-PS-HT	Explorer Mag 2 DwrPolice Package No 3rd Row Seat; Heavy Duty Table	\$3,540.00	\$3,031.74
336320	TruckVault Inc.	T-FDEXRM2-20N-PS-LR	Explorer Mag 2 Dwr	\$3,725.00	\$3,190.18
336320	TruckVault Inc.	T-FDEXRM2-20N-PS-LT	Explorer Mag 2 Dwr	\$3,645.00	\$3,121.66
336320	TruckVault Inc.	T-FDEXRM2-20N-PS-P7	Explorer Mag 2 DwrPolice Package; 7" Shorten	\$2,645.00	\$2,265.24
336320	TruckVault Inc.	T-FDEXRM2-20N-PS-PP	Explorer Mag 2 Dwr	\$2,845.00	\$2,436.52
336320	TruckVault Inc.	T-FDEXRM2-20N-PS-PP-HT	Explorer Mag 2 Dwr HD TablePolice Package No 3rd Row Seat	\$3,540.00	\$3,031.74
336320	TruckVault Inc.	T-FDEXRM2-20N-PS-PP-LR	Explorer Magnum 2 DwrPolice Package; Prisoner Cage; Radio Lift & Tray	\$3,645.00	\$3,121.66
336320	TruckVault Inc.	T-FDEXRM2-20N-PS-PP-LT	Explorer Mag 2 Dwr	\$3,645.00	\$3,121.66
336320	TruckVault Inc.	T-FDEXRM2-20N-PS-PP-ZC11146	Explorer Mag 2 DwrPolice Package No 3rd Row Seat	\$2,855.00	\$2,445.09
336320	TruckVault Inc.	T-FDEXRM2-20S	Explorer Mag 2 Dwr	\$2,445.00	\$2,093.95
336320	TruckVault Inc.	T-FDEXRMO-02N	Ford Explorer Mag OS Dwr, dimensions: 40L x 44.5W	\$2,845.00	\$2,436.52
336320	TruckVault Inc.	T-FDEXRMO-02N-PP	Ford Explorer Mag OS Dwr, dimensions: 37L x 44.5W	\$2,845.00	\$2,436.52
336320	TruckVault Inc.	T-FDEXRMO-02N-PT	Ford Explorer Mag OS Dwr, dimensions: 39L x 44.5W	\$3,540.00	\$3,031.74
336320	TruckVault Inc.	T-FDEXRMO-06N	Ford Explorer Mag OS Dwr, dimensions: 38.5L x 44.5W	\$2,845.00	\$2,436.52
336320	TruckVault Inc.	T-FDEXRMO-06N-PP	Ford Explorer Mag OS Dwr, dimensions: 35.5L x 44.5W	\$2,645.00	\$2,265.24
336320	TruckVault Inc.	T-FDEXRMO-06N-PT	Ford Explorer Mag OS Dwr, dimensions: 37.5L x 44.5W	\$3,540.00	\$3,031.74
336320	TruckVault Inc.	T-FDEXRMO-06N-T3	Ford Explorer Mag OS Dwr, dimensions: 36.5L x 44.5W	\$2,845.00	\$2,436.52
336320	TruckVault Inc.	T-FDEXRMO-06N-T3-PP	Ford Explorer Mag OS Dwr, dimensions: 33.5L x 44.5W	\$2,645.00	\$2,265.24
336320	TruckVault Inc.	T-FDEXRMO-06N-T3-PT	Ford Explorer Mag OS Dwr, dimensions: 35.5L x 44.5W	\$3,340.00	\$2,860.45
336320	TruckVault Inc.	T-FDEXRMO-11N	Ford Explorer Mag Offset, dimensions: 41L x 40W	\$2,845.00	\$2,436.52
336320	TruckVault Inc.	T-FDEXRMO-11N-LT	Ford Explorer Mag Offset, dimensions: 41L x 40W	\$3,540.00	\$3,031.74
336320	TruckVault Inc.	T-FDEXRMO-11N-PP	Ford Explorer Mag Offset, dimensions: 38L x 40W	\$2,845.00	\$2,436.52
336320	TruckVault Inc.	T-FDEXRMO-11N-PS	Ford Explorer Mag Offset, dimensions: 41L x 40W	\$2,845.00	\$2,436.52
336320	TruckVault Inc.	T-FDEXRMO-11N-PS-LT	Ford Explorer Mag Offset Dwr, dimensions: 41L x 40W	\$3,440.00	\$2,946.10
336320	TruckVault Inc.	T-FDEXRMO-11N-PS-P7	Ford Explorer Mag Offset, dimensions: 34L x 40W	\$2,645.00	\$2,265.24
336320	TruckVault Inc.	T-FDEXRMO-11N-PS-PP	Ford Explorer Mag Offset, dimensions: 38L x 40W	\$2,845.00	\$2,436.52
336320	TruckVault Inc.	T-FDEXRMO-11N-PS-PP-LT	Ford Explorer Mag Offset, dimensions: 36L x 40W	\$3,440.00	\$2,946.10
336320	TruckVault Inc.	T-FDEXRMO-11N-PS-PP-PT	Ford Explorer Mag OS Dwr, dimensions: 36L x 40W	\$3,540.00	\$3,031.74
336320	TruckVault Inc.	T-FDEXRMO-11N-PS-PT	Ford Explorer Mag Offset, dimensions: 39L x 40W	\$3,540.00	\$3,031.74
336320	TruckVault Inc.	T-FDEXRMO-11N-PS-SA	Ford Explorer Mag Offset, dimensions: 28L x 40W	\$2,645.00	\$2,265.24
336320	TruckVault Inc.	T-FDEXRMO-20N	Explorer Mag Offset Dwr	\$2,845.00	\$2,436.52
336320	TruckVault Inc.	T-FDEXRMO-20N-HG	Explorer Magnum 2 Offset DrawerElevated Version; 3rd Row Removed	\$2,185.00	\$1,871.28
336320	TruckVault Inc.	T-FDEXRMO-20N-HT	Explorer Mag Offset DwrFolding 3rd Row Seat HD Table	\$3,540.00	\$3,031.74
336320	TruckVault Inc.	T-FDEXRMO-20N-LT	Explorer Mag 2 Offset Dwr	\$3,645.00	\$3,121.66
336320	TruckVault Inc.	T-FDEXRMO-20N-PS	Explorer Mag Offset	\$2,845.00	\$2,436.52
336320	TruckVault Inc.	T-FDEXRMO-20N-PS-LT	Explorer Mag 2 Offset Dwr	\$3,645.00	\$3,121.66
336320	TruckVault Inc.	T-FDEXRMO-20N-PS-PP-LT	Explorer Mag Offset	\$3,645.00	\$3,121.66
336320	TruckVault Inc.	T-FDEXRMO-20S	Explorer Mag Offset Dwr	\$2,445.00	\$2,093.95
336320	TruckVault Inc.	T-FDEXRNO-11N-PS-C1-ZC10694A	Explorer CustomC10694A	\$775.00	\$663.73
336320	TruckVault Inc.	T-FDEXRNO-11N-PS-C1-ZC8070	Explorer Custom	\$1,575.00	\$1,348.87

336320	TruckVault Inc.	T-FDEXRN0-11N-PS-C9-ZC8991	Explorer Custom	\$1,885.00	\$1,614.36
336320	TruckVault Inc.	T-FDEXRN0-11N-PS-ZC10001	Explorer Custom Tray	\$1,765.00	\$1,511.59
336320	TruckVault Inc.	T-FDEXRN0-11N-PS-ZC8761	Explorer Custom	\$1,065.00	\$912.09
336320	TruckVault Inc.	T-FDEXRN0-11N-ZC8710	Explorer Cust Sliding Tray	\$785.00	\$672.29
336320	TruckVault Inc.	T-FDEXRN0-20N-PS-C2-Z1	Explorer Floor Vault	\$3,085.00	\$2,642.07
336320	TruckVault Inc.	T-FDEXRN0-20N-PS-C3-ZC11464C	Explorer Custom	\$2,300.00	\$1,969.77
336320	TruckVault Inc.	T-FDEXRN0-20N-PS-C3-ZC11537B	Explorer 1 Drawer	\$1,350.00	\$1,156.17
336320	TruckVault Inc.	T-FDEXRN1-11N-HG-ZC8359	Explorer 1 Drawer	\$1,575.00	\$1,348.87
336320	TruckVault Inc.	T-FDEXRN1-11N-PP-ZC7454	Explorer CUST 1 Dwr	\$2,365.00	\$2,025.44
336320	TruckVault Inc.	T-FDEXRN1-11N-PS-PP-ZC10617A	Explorer Custom 1 DwrNo3rd Row Seat, Prisoner	\$2,585.00	\$2,213.85
336320	TruckVault Inc.	T-FDEXRN1-11N-PS-PP-ZC9045	Explorer Custom	\$2,085.00	\$1,785.64
336320	TruckVault Inc.	T-FDEXRN1-11N-PS-ZC7456	Explorer CUST 1 Dwr	\$2,365.00	\$2,025.44
336320	TruckVault Inc.	T-FDEXRN1-20N-PS-C1-ZC11538B	Explorer Custom	\$2,595.00	\$2,222.42
336320	TruckVault Inc.	T-FDEXRN1-20N-PS-HG-ZC10960	Explorer CustomC10960	\$1,975.00	\$1,691.44
336320	TruckVault Inc.	T-FDEXRN1-20N-PS-PP-ZC11043	Explorer CustomC11043	\$2,455.00	\$2,102.52
336320	TruckVault Inc.	T-FDEXRN1-20N-PS-ZC10575B	Explorer 10 7/8 Interior 1 DwrPolice Package; No 3rd Row Seat	\$2,455.00	\$2,102.52
336320	TruckVault Inc.	T-FDEXRN1-20N-PS-ZC10576B	Explorer 10 7/8 Interior 1 DwrPolice Package; No 3rd Row Seat	\$2,455.00	\$2,102.52
336320	TruckVault Inc.	T-FDEXRN2-11N-PS-HT-PT-ZC8280	Explorer Cust 2 Dwr	\$4,515.00	\$3,866.75
336320	TruckVault Inc.	T-FDEXRN2-11N-PS-TT-ZC7948	Explorer Cust 2 Dwr	\$3,645.00	\$3,121.66
336320	TruckVault Inc.	T-FDEXRN2-20N-PS-PP-HT-ZC10904	Explorer 13' 2 Dwr HD Table	\$3,850.00	\$3,297.23
336320	TruckVault Inc.	T-FDEXRS1-02N	Ford Explorer Std 1 Dwr, dimensions: 41.5L x 44.5W	\$2,095.00	\$1,794.21
336320	TruckVault Inc.	T-FDEXRS1-02N-PP	Ford Explorer Std 1 Dwr, dimensions: 38.5L x 44.5W	\$2,095.00	\$1,794.21
336320	TruckVault Inc.	T-FDEXRS1-02N-PT	Ford Explorer Std 1 Dwr, dimensions: 39L x 44.5W	\$2,790.00	\$2,389.42
336320	TruckVault Inc.	T-FDEXRS1-06N	Ford Explorer Std 1 Dwr, dimensions: 40L x 44.5W	\$2,095.00	\$1,794.21
336320	TruckVault Inc.	T-FDEXRS1-06N-PP	Ford Explorer Std 1 Dwr, dimensions: 37L x 44.5W	\$2,095.00	\$1,794.21
336320	TruckVault Inc.	T-FDEXRS1-06N-PT	Ford Explorer Std 1 Dwr, dimensions: 39L x 44.5W	\$2,790.00	\$2,389.42
336320	TruckVault Inc.	T-FDEXRS1-06N-T3	Ford Explorer Std 1 Dwr, dimensions: 37L x 44.5W	\$2,095.00	\$1,794.21
336320	TruckVault Inc.	T-FDEXRS1-11N	Ford Explorer Std 1 Dwr, dimensions: 43L x 40W	\$2,095.00	\$1,794.21
336320	TruckVault Inc.	T-FDEXRS1-11N-HG	Explorer Standard 1 Drawer	\$1,745.00	\$1,494.46
336320	TruckVault Inc.	T-FDEXRS1-11N-HT-LT	Explorer Std 1 Dwr	\$3,485.00	\$2,984.63
336320	TruckVault Inc.	T-FDEXRS1-11N-LT	Ford Explorer Std 1 Dwr, dimensions: 41L x 40W	\$2,790.00	\$2,389.42
336320	TruckVault Inc.	T-FDEXRS1-11N-PP	Ford Explorer Std 1 Dwr, dimensions: 40L x 40W	\$2,095.00	\$1,794.21
336320	TruckVault Inc.	T-FDEXRS1-11N-PP-HT-LT	Explorer Std 1 Dwr	\$3,485.00	\$2,984.63
336320	TruckVault Inc.	T-FDEXRS1-11N-PP-LT	Ford Explorer Std 1 Dwr, dimensions: 36L x 40W	\$2,790.00	\$2,389.42
336320	TruckVault Inc.	T-FDEXRS1-11N-PS	Ford Explorer Std 1 Dwr, dimensions: 43L x 40W	\$2,095.00	\$1,794.21
336320	TruckVault Inc.	T-FDEXRS1-11N-PS-HG	Explorer Standard 1 Drawer	\$1,745.00	\$1,494.46
336320	TruckVault Inc.	T-FDEXRS1-11N-PS-HT-LT	Ford Explorer Std 1 Dwr, dimensions: 36L x 40W	\$3,385.00	\$2,898.99
336320	TruckVault Inc.	T-FDEXRS1-11N-PS-LT	Ford Explorer Std 1 Dwr, dimensions: 41L x 40W	\$2,690.00	\$2,303.78
336320	TruckVault Inc.	T-FDEXRS1-11N-PS-P7	Ford Explorer Std 1 Dwr, dimensions: 36L x 40W	\$2,095.00	\$1,794.21
336320	TruckVault Inc.	T-FDEXRS1-11N-PS-PP	Ford Explorer Std 1 Dwr, dimensions: 40L x 40W	\$2,095.00	\$1,794.21
336320	TruckVault Inc.	T-FDEXRS1-11N-PS-PP-HT-LT	Ford Explorer Std 1 Dwr, dimensions: 36L x 40W	\$3,385.00	\$2,898.99
336320	TruckVault Inc.	T-FDEXRS1-11N-PS-PP-LT	Ford Explorer Std 1 Dwr, dimensions: 36L x 40W	\$2,690.00	\$2,303.78
336320	TruckVault Inc.	T-FDEXRS1-11N-PS-PP-PT	Ford Explorer Std 1 Dwr, dimensions: 40L x 40W	\$2,790.00	\$2,389.42
336320	TruckVault Inc.	T-FDEXRS1-11N-PS-PP-PT-LT	Ford Explorer Std 1 Dwr, dimensions: 36L x 40W	\$3,385.00	\$2,898.99
336320	TruckVault Inc.	T-FDEXRS1-11N-PS-PP-TT-LT	Ford Explorer Std 1 Dwr, dimensions: 36L x 40W	\$3,635.00	\$3,113.10
336320	TruckVault Inc.	T-FDEXRS1-11N-PS-PT-LT	Ford Explorer Std 1 Dwr, dimensions: 41L x 40W	\$3,385.00	\$2,898.99
336320	TruckVault Inc.	T-FDEXRS1-11N-PS-SA	Ford Explorer Std 1 Dwr, dimensions: 28L x 40W	\$1,895.00	\$1,622.92
336320	TruckVault Inc.	T-FDEXRS1-11N-PS-SA-PP	Ford Explorer Std 1 Dwr, dimensions: 25L x 40W	\$1,895.00	\$1,622.92
336320	TruckVault Inc.	T-FDEXRS1-11N-PS-TT-LT	Explorer Std 1 Dwr	\$3,635.00	\$3,113.10
336320	TruckVault Inc.	T-FDEXRS1-11N-PS-ZC9910	Explorer Custom	\$1,765.00	\$1,511.59
336320	TruckVault Inc.	T-FDEXRS1-11N-SA	Ford Explorer Std 1 Dwr, dimensions: 32L x 40W	\$1,895.00	\$1,622.92
336320	TruckVault Inc.	T-FDEXRS1-11N-TR-ZC8822	Explorer Custom 1 Drawer	\$1,685.00	\$1,443.07
336320	TruckVault Inc.	T-FDEXRS1-11N-ZC8165	Explorer Std 1 Dwr	\$1,685.00	\$1,443.07
336320	TruckVault Inc.	T-FDEXRS1-11N-ZC8822	Explorer Custom 1 Drawer	\$1,685.00	\$1,443.07
336320	TruckVault Inc.	T-FDEXRS1-20N	Explorer Std 1 Dwr	\$2,095.00	\$1,794.21
336320	TruckVault Inc.	T-FDEXRS1-20N-HG	Explorer Standard 1 Drawer	\$1,845.00	\$1,580.10
336320	TruckVault Inc.	T-FDEXRS1-20N-HT	Explorer Std 1 Dwr No 3rd Row Seat; Heavy Duty Table	\$2,790.00	\$2,389.42
336320	TruckVault Inc.	T-FDEXRS1-20N-HT-LT	Explorer Std 1 Dwr	\$3,590.00	\$3,074.56
336320	TruckVault Inc.	T-FDEXRS1-20N-LT	Explorer Std 1 Dwr	\$2,895.00	\$2,479.35
336320	TruckVault Inc.	T-FDEXRS1-20N-PS	Explorer Std 1 Dwr	\$2,095.00	\$1,794.21
336320	TruckVault Inc.	T-FDEXRS1-20N-PS-HG	Explorer Standard 1 Drawer	\$1,845.00	\$1,580.10
336320	TruckVault Inc.	T-FDEXRS1-20N-PS-HT	Explorer Std 1 Dwr	\$2,790.00	\$2,389.42
336320	TruckVault Inc.	T-FDEXRS1-20N-PS-HT-LT	Explorer Std 1 Dwr	\$3,590.00	\$3,074.56
336320	TruckVault Inc.	T-FDEXRS1-20N-PS-LR	Explorer Std 1 Dwr	\$3,225.00	\$2,761.96
336320	TruckVault Inc.	T-FDEXRS1-20N-PS-LT	Explorer Std 1 Dwr	\$2,895.00	\$2,479.35
336320	TruckVault Inc.	T-FDEXRS1-20N-PS-P7	Explorer Std 1 DwrPolice Package; 7" Shorten	\$2,095.00	\$1,794.21
336320	TruckVault Inc.	T-FDEXRS1-20N-PS-P7-Z1	Explorer Std 1 Dwr	\$1,975.00	\$1,691.44
336320	TruckVault Inc.	T-FDEXRS1-20N-PS-PP	Explorer Std 1 Dwr	\$2,095.00	\$1,794.21
336320	TruckVault Inc.	T-FDEXRS1-20N-PS-PP-HT-LR	Explorer Std 1 DwrPolice Package; Radio Lift & Tray	\$3,790.00	\$3,245.84

336320	TruckVault Inc.	T-FDEXRS1-20N-PS-PP-HT-LT	Explorer Std 1 Dwr	\$3,590.00	\$3,074.56
336320	TruckVault Inc.	T-FDEXRS1-20N-PS-PP-LR	Explorer Std 1 DwrPolice Package; Prisoner Cage; Radio Lift & Tray	\$3,295.00	\$2,821.91
336320	TruckVault Inc.	T-FDEXRS1-20N-PS-PP-LT	Explorer Std 1 Dwr	\$2,895.00	\$2,479.35
336320	TruckVault Inc.	T-FDEXRS1-20N-PS-RD-HG	Explorer Standard 1 DrawerElevated Version; Radio Drawer; Police Version	\$2,295.00	\$1,965.49
336320	TruckVault Inc.	T-FDEXRS1-20N-PS-SA	Explorer Std 1 Dwr	\$1,895.00	\$1,622.92
336320	TruckVault Inc.	T-FDEXRS1-20N-PS-ZC10414	Explorer Std 1 Dwr CustomC10414	\$1,595.00	\$1,365.99
336320	TruckVault Inc.	T-FDEXRS1-20N-SA	Explorer Std 1 DwrSpare Access	\$1,895.00	\$1,622.92
336320	TruckVault Inc.	T-FDEXRS1-20N-ZC10414	Explorer Std 1 DwrC10414	\$1,595.00	\$1,365.99
336320	TruckVault Inc.	T-FDEXRS1-20S	Explorer Std 1 Dwr	\$1,695.00	\$1,451.64
336320	TruckVault Inc.	T-FDEXRS2-02N	Ford Explorer Std 2 Dwr, dimensions: 41.5L x 44.5W	\$2,645.00	\$2,265.24
336320	TruckVault Inc.	T-FDEXRS2-02N-PT	Ford Explorer Std 2 Dwr, dimensions: 40.5L x 44.5W	\$3,340.00	\$2,860.45
336320	TruckVault Inc.	T-FDEXRS2-06N	Ford Explorer Std 2 Dwr, dimensions: 40L x 44.5W	\$2,645.00	\$2,265.24
336320	TruckVault Inc.	T-FDEXRS2-06N-PP	Ford Explorer Std 2 Dwr, dimensions: 37L x 44.5W	\$2,645.00	\$2,265.24
336320	TruckVault Inc.	T-FDEXRS2-06N-PT	Ford Explorer Std 2 Dwr, dimensions: 39L x 44.5W	\$3,340.00	\$2,860.45
336320	TruckVault Inc.	T-FDEXRS2-11N	Ford Explorer Std 2 Dwr, dimensions: 43L x 40W	\$2,645.00	\$2,265.24
336320	TruckVault Inc.	T-FDEXRS2-11N-BS	Ford Explorer Std 2 Dwr, dimensions: 0L x 0W	\$2,645.00	\$2,265.24
336320	TruckVault Inc.	T-FDEXRS2-11N-HT-LT	Explorer Std 2 Dwr	\$4,035.00	\$3,455.67
336320	TruckVault Inc.	T-FDEXRS2-11N-LT	Explorer Std 2 Dwr	\$3,340.00	\$2,860.45
336320	TruckVault Inc.	T-FDEXRS2-11N-PP	Ford Explorer Std 2 Dwr, dimensions: 40L x 40W	\$2,645.00	\$2,265.24
336320	TruckVault Inc.	T-FDEXRS2-11N-PP-LT	Explorer Std 2 Dwr	\$3,340.00	\$2,860.45
336320	TruckVault Inc.	T-FDEXRS2-11N-PS	Ford Explorer Std 2 Dwr, dimensions: 43L x 40W	\$2,645.00	\$2,265.24
336320	TruckVault Inc.	T-FDEXRS2-11N-PS-HG	Explorer Std 2 Drawer	\$2,185.00	\$1,871.28
336320	TruckVault Inc.	T-FDEXRS2-11N-PS-HT-LT	Explorer Std 2 Dwr	\$3,935.00	\$3,370.03
336320	TruckVault Inc.	T-FDEXRS2-11N-PS-LT	Ford Explorer Std 2 Dwr, dimensions: 41L x 40W	\$3,240.00	\$2,774.81
336320	TruckVault Inc.	T-FDEXRS2-11N-PS-P7	Ford Explorer Std 2 Dwr, dimensions: 36L x 40W	\$2,645.00	\$2,265.24
336320	TruckVault Inc.	T-FDEXRS2-11N-PS-PP	Ford Explorer Std 2 Dwr, dimensions: 40L x 40W	\$2,645.00	\$2,265.24
336320	TruckVault Inc.	T-FDEXRS2-11N-PS-PP-HT-LT	Explorer Std 2 Dwr	\$3,935.00	\$3,370.03
336320	TruckVault Inc.	T-FDEXRS2-11N-PS-PP-LT	Ford Explorer Std 2 Dwr, dimensions: 36L x 40W	\$3,240.00	\$2,774.81
336320	TruckVault Inc.	T-FDEXRS2-11N-PS-PP-PT	Ford Explorer Std 2 Dwr, dimensions: 40L x 40W	\$3,340.00	\$2,860.45
336320	TruckVault Inc.	T-FDEXRS2-11N-PS-PP-PT-LT	Explorer Std 2 Dwr	\$3,735.00	\$3,198.74
336320	TruckVault Inc.	T-FDEXRS2-11N-PS-PT	Explorer Std 2 Dwr	\$3,340.00	\$2,860.45
336320	TruckVault Inc.	T-FDEXRS2-11N-PS-PT-LT	Ford Explorer Std 2 Dwr, dimensions: 41L x 40W	\$3,935.00	\$3,370.03
336320	TruckVault Inc.	T-FDEXRS2-11N-PS-SA	Ford Explorer Std 2 Dwr, dimensions: 28L x 40W	\$2,445.00	\$2,093.95
336320	TruckVault Inc.	T-FDEXRS2-11N-PS-SA-P7	Explorer Std 2 Dwr	\$2,245.00	\$1,922.67
336320	TruckVault Inc.	T-FDEXRS2-11N-PT	Ford Explorer Std 2 Dwr, dimensions: 42L x 40W	\$3,340.00	\$2,860.45
336320	TruckVault Inc.	T-FDEXRS2-11N-PT-LT	Ford Explorer Std 2 Dwr, dimensions: 41L x 40W	\$4,035.00	\$3,455.67
336320	TruckVault Inc.	T-FDEXRS2-11N-SA	Ford Explorer Std 2 Dwr, dimensions: 32L x 40W	\$2,445.00	\$2,093.95
336320	TruckVault Inc.	T-FDEXRS2-20N	Explorer Std 2 Dwr	\$2,645.00	\$2,265.24
336320	TruckVault Inc.	T-FDEXRS2-20N-LT	Explorer Std 2 DwrLift	\$3,445.00	\$2,950.38
336320	TruckVault Inc.	T-FDEXRS2-20N-PS	Explorer Std 2 Dwr	\$2,645.00	\$2,265.24
336320	TruckVault Inc.	T-FDEXRS2-20N-PS-HG	Explorer Std 2 Drawer	\$2,145.00	\$1,837.03
336320	TruckVault Inc.	T-FDEXRS2-20N-PS-HT-LT	Explorer Std 2 DwrPolice Pack; Hvy Tbl, Lift;	\$4,140.00	\$3,545.59
336320	TruckVault Inc.	T-FDEXRS2-20N-PS-LR	Explorer Std 2 Dwr	\$3,845.00	\$3,292.95
336320	TruckVault Inc.	T-FDEXRS2-20N-PS-LT	Explorer Std 2 Dwr	\$3,445.00	\$2,950.38
336320	TruckVault Inc.	T-FDEXRS2-20N-PS-P7	Explorer Std 2 DwrPolice Package; 7" Shorten	\$2,645.00	\$2,265.24
336320	TruckVault Inc.	T-FDEXRS2-20N-PS-PP	Explorer Std 2 Dwr	\$2,645.00	\$2,265.24
336320	TruckVault Inc.	T-FDEXRS2-20N-PS-PP-HT-LR	Explorer Std 2 Dwr	\$4,340.00	\$3,716.88
336320	TruckVault Inc.	T-FDEXRS2-20N-PS-PP-HT-LT	Explorer Std 2 Dwr	\$4,140.00	\$3,545.59
336320	TruckVault Inc.	T-FDEXRS2-20N-PS-PP-LR	Explorer Std 2 Dwr	\$3,725.00	\$3,190.18
336320	TruckVault Inc.	T-FDEXRS2-20N-PS-PP-LT	Explorer Std 2 Dwr	\$3,245.00	\$2,779.09
336320	TruckVault Inc.	T-FDEXRS2-20S	Explorer Std 2 Dwr	\$2,245.00	\$1,922.67
336320	TruckVault Inc.	T-FDEXRSO-02N	Ford Explorer Std OS Dwr, dimensions: 41.5L x 44.5W	\$2,645.00	\$2,265.24
336320	TruckVault Inc.	T-FDEXRSO-02N-PP	Ford Explorer Std OS Dwr, dimensions: 38.5L x 44.5W	\$2,645.00	\$2,265.24
336320	TruckVault Inc.	T-FDEXRSO-02N-PT	Ford Explorer Std OS Dwr, dimensions: 40.5L x 44.5W	\$3,340.00	\$2,860.45
336320	TruckVault Inc.	T-FDEXRSO-06N	Ford Explorer Std OS Dwr, dimensions: 40L x 44.5W	\$2,645.00	\$2,265.24
336320	TruckVault Inc.	T-FDEXRSO-06N-PP	Ford Explorer Std OS Dwr, dimensions: 37L x 44.5W	\$2,645.00	\$2,265.24
336320	TruckVault Inc.	T-FDEXRSO-06N-PT	Ford Explorer Std OS Dwr, dimensions: 39L x 44.5W	\$3,340.00	\$2,860.45
336320	TruckVault Inc.	T-FDEXRSO-11N	Ford Explorer Std Offset Dwr, dimensions: 43L x 40W	\$2,645.00	\$2,265.24
336320	TruckVault Inc.	T-FDEXRSO-11N-LT	Explorer Std Offset	\$3,340.00	\$2,860.45
336320	TruckVault Inc.	T-FDEXRSO-11N-PP	Ford Explorer Std Offset Dwr, dimensions: 40L x 40W	\$2,645.00	\$2,265.24
336320	TruckVault Inc.	T-FDEXRSO-11N-PP-PS	Ford Explorer Std Offset Dwr, dimensions: 40L x 40W	\$2,645.00	\$2,265.24
336320	TruckVault Inc.	T-FDEXRSO-11N-PS	Ford Explorer Std Offset Dwr, dimensions: 43L x 40W	\$2,645.00	\$2,265.24
336320	TruckVault Inc.	T-FDEXRSO-11N-PS-HT-LT	Explorer Std Offset Dwr	\$3,935.00	\$3,370.03
336320	TruckVault Inc.	T-FDEXRSO-11N-PS-LT	Ford Explorer Std Offset Dwr, dimensions: 41L x 40W	\$3,240.00	\$2,774.81
336320	TruckVault Inc.	T-FDEXRSO-11N-PS-P7	Ford Explorer Std Offset Dwr, dimensions: 36L x 40W	\$2,645.00	\$2,265.24
336320	TruckVault Inc.	T-FDEXRSO-11N-PS-PP	Ford Explorer Std Offset Dwr, dimensions: 40L x 40W	\$2,645.00	\$2,265.24
336320	TruckVault Inc.	T-FDEXRSO-11N-PS-PP-HT-LT	Explorer Std OS Dwr	\$3,935.00	\$3,370.03
336320	TruckVault Inc.	T-FDEXRSO-11N-PS-PP-LT	Ford Explorer Std Offset Dwr, dimensions: 36L x 40W	\$3,240.00	\$2,774.81



336320	TruckVault Inc.	T-FDEXRSO-11N-PS-PP-PT	Ford Explorer Std Offset Dwr, dimensions: 40L x 40W	\$3,340.00	\$2,860.45
336320	TruckVault Inc.	T-FDEXRSO-11N-PS-SA	Ford Explorer Std OS Dwr, dimensions: 28L x 40W	\$2,445.00	\$2,093.95
336320	TruckVault Inc.	T-FDEXRSO-11N-PT-LT	Explorer Std OS Dwr	\$4,035.00	\$3,455.67
336320	TruckVault Inc.	T-FDEXRSO-11N-SA	Ford Explorer Std Offset Dwr, dimensions: 32L x 40W	\$2,445.00	\$2,093.95
336320	TruckVault Inc.	T-FDEXRSO-20N	Explorer Std Offset Dwr	\$2,645.00	\$2,265.24
336320	TruckVault Inc.	T-FDEXRSO-20N-LT	Explorer Std Offset DwrLift	\$3,445.00	\$2,950.38
336320	TruckVault Inc.	T-FDEXRSO-20N-PS	Explorer Std Offset Dwr	\$2,645.00	\$2,265.24
336320	TruckVault Inc.	T-FDEXRSO-20N-PS-HT-LT	Explorer Std OS DwrPolice Pack; Hvy Tbl, Lift;	\$4,140.00	\$3,545.59
336320	TruckVault Inc.	T-FDEXRSO-20N-PS-LT	Explorer Std Offset Dwr	\$3,445.00	\$2,950.38
336320	TruckVault Inc.	T-FDEXRSO-20N-PS-PP	Explorer Std Offset Dwr	\$2,645.00	\$2,265.24
336320	TruckVault Inc.	T-FDEXRSO-20N-PS-PP-HT	Explorer Std Offset DwrPolice; P-Cage HD Table	\$3,340.00	\$2,860.45
336320	TruckVault Inc.	T-FDEXRSO-20N-PS-PP-HT-LT	Explorer Std OS DwrPolice Pack; Hvy Tbl, Lift; P-Cage	\$4,140.00	\$3,545.59
336320	TruckVault Inc.	T-FDEXRSO-20N-PS-PP-LT	Explorer Std 2 Dwr Off SetPolice Package; Lift	\$3,445.00	\$2,950.38
336320	TruckVault Inc.	T-FDEXRSO-20S	Explorer Std Offset Dwr	\$2,245.00	\$1,922.67
336320	TruckVault Inc.	T-FDEXRU1-06N-T3	Explorer Utility 1 Dwr	\$2,195.00	\$1,879.85
336320	TruckVault Inc.	T-FDEXRU1-11N	Explorer Utility 1 Dwr	\$2,195.00	\$1,879.85
336320	TruckVault Inc.	T-FDEXRU1-11N-HG	Explorer Utility 1 Drawer	\$1,855.00	\$1,588.66
336320	TruckVault Inc.	T-FDEXRU1-11N-LT	Explorer Utility 1 Dwr	\$2,890.00	\$2,475.06
336320	TruckVault Inc.	T-FDEXRU1-11N-PP-LT	Explorer Utility 1 Dwr	\$2,890.00	\$2,475.06
336320	TruckVault Inc.	T-FDEXRU1-11N-PS	Explorer Utility 1 Dwr	\$2,195.00	\$1,879.85
336320	TruckVault Inc.	T-FDEXRU1-11N-PS-HG	Explorer Utility Height 1 Drawer	\$1,855.00	\$1,588.66
336320	TruckVault Inc.	T-FDEXRU1-11N-PS-LT	Explorer Utility 1 Dwr	\$2,790.00	\$2,389.42
336320	TruckVault Inc.	T-FDEXRU1-11N-PS-PP	Explorer Utility 1 Dwr	\$2,195.00	\$1,879.85
336320	TruckVault Inc.	T-FDEXRU1-11N-PS-PP-LT	Explorer Utility 1 Dwr	\$2,790.00	\$2,389.42
336320	TruckVault Inc.	T-FDEXRU1-11N-PS-PP-MT-ZC10789	Explorer Utility 1 DwrPolice Package No 3rd Row; P-Cage	\$2,225.00	\$1,905.54
336320	TruckVault Inc.	T-FDEXRU1-20N	Explorer Utility 1 DwrFolding 3rd Row Seat	\$2,195.00	\$1,879.85
336320	TruckVault Inc.	T-FDEXRU1-20N-HG	Explorer Utility Height 1 Drawer	\$2,075.00	\$1,777.08
336320	TruckVault Inc.	T-FDEXRU1-20N-LT	Explorer Utility 1 DwrCivilian; Lift	\$2,995.00	\$2,564.99
336320	TruckVault Inc.	T-FDEXRU1-20N-PS	Explorer Utility 1 Dwr	\$2,195.00	\$1,879.85
336320	TruckVault Inc.	T-FDEXRU1-20N-PS-HG	Explorer Utility Height 1 Drawer	\$1,945.00	\$1,665.74
336320	TruckVault Inc.	T-FDEXRU1-20N-PS-HT	Explorer Utility 1 Dwr	\$2,890.00	\$2,475.06
336320	TruckVault Inc.	T-FDEXRU1-20N-PS-LR	Explorer Utility 1 Dwr	\$3,195.00	\$2,736.27
336320	TruckVault Inc.	T-FDEXRU1-20N-PS-LT	Explorer Utility 1 Dwr	\$2,995.00	\$2,564.99
336320	TruckVault Inc.	T-FDEXRU1-20N-PS-P7	Explorer Utility 1 DwrPolice Package; 7" Shorten	\$1,995.00	\$1,708.56
336320	TruckVault Inc.	T-FDEXRU1-20N-PS-PP	Explorer Utility 1 Dwr	\$2,195.00	\$1,879.85
336320	TruckVault Inc.	T-FDEXRU1-20N-PS-PP-HT	Explorer Utility 1 DwrPolice Package No 3rd Row; P-Cage	\$2,890.00	\$2,475.06
336320	TruckVault Inc.	T-FDEXRU1-20N-PS-PP-LR	Explorer Utility 1 DwrPolice Package; Prisoner Cage; Radio Lift & Tray	\$2,995.00	\$2,564.99
336320	TruckVault Inc.	T-FDEXRU1-20N-PS-PP-LT	Explorer Utility 1 Dwr	\$2,995.00	\$2,564.99
336320	TruckVault Inc.	T-FDEXRU1-20N-PS-PP-PT-LT	Explorer Utility 1 Dwr	\$2,995.00	\$2,564.99
336320	TruckVault Inc.	T-FDEXRU1-20N-PS-RD-HG	Explorer Utility Height 1 DrawerElevated Version; Radio Drawer; Police Package	\$2,395.00	\$2,051.13
336320	TruckVault Inc.	T-FDEXRU1-20N-PS-RD-HG-ZC10577	Explorer Utility Height 1 DrawerElevated Version; Radio Drawer; C10577	\$2,555.00	\$2,188.16
336320	TruckVault Inc.	T-FDEXRU1-20N-PS-SA	Explorer Utility 1 Dwr	\$1,995.00	\$1,708.56
336320	TruckVault Inc.	T-FDEXRU1-20N-PS-Z1	Explorer Utility 1 Dwr	\$1,805.00	\$1,545.84
336320	TruckVault Inc.	T-FDEXRU1-20N-SA	Explorer Utility 1 DwrSpare Access	\$1,995.00	\$1,708.56
336320	TruckVault Inc.	T-FDEXRU1-20S	Explorer Utility 1 Dwr	\$1,795.00	\$1,537.28
336320	TruckVault Inc.	T-FDEXRU2-11N	Explorer Utility 2 Dwr	\$2,745.00	\$2,350.88
336320	TruckVault Inc.	T-FDEXRU2-11N-HG-ZC8332	Explorer 2 Drawer	\$2,025.00	\$1,734.26
336320	TruckVault Inc.	T-FDEXRU2-11N-LT	Explorer Utility 2 Dwr	\$3,440.00	\$2,946.10
336320	TruckVault Inc.	T-FDEXRU2-11N-PP-LT	Explorer Utility 2 Dwr	\$3,440.00	\$2,946.10
336320	TruckVault Inc.	T-FDEXRU2-20N-PS	Explorer Utility 2 Dwr	\$2,745.00	\$2,350.88
336320	TruckVault Inc.	T-FDEXRU2-11N-PS-LT	Explorer Utility 2 Dwr	\$3,340.00	\$2,860.45
336320	TruckVault Inc.	T-FDEXRU2-11N-PS-PP	Explorer Utility 2 Dwr	\$2,745.00	\$2,350.88
336320	TruckVault Inc.	T-FDEXRU2-11N-PS-PP-HT	Explorer Utility 2 Dwr Pullout Table	\$3,440.00	\$2,946.10
336320	TruckVault Inc.	T-FDEXRU2-11N-PS-PP-LT	Explorer Utility 2 Dwr	\$3,340.00	\$2,860.45
336320	TruckVault Inc.	T-FDEXRU2-20N	Explorer Utility 2 Dwr	\$2,745.00	\$2,350.88
336320	TruckVault Inc.	T-FDEXRU2-20N-PP-LT	Explorer Utility 2 DwrCivilian; Lift : cage	\$3,545.00	\$3,036.02
336320	TruckVault Inc.	T-FDEXRU2-20N-PS	Explorer Utility 2 Dwr	\$2,745.00	\$2,350.88
336320	TruckVault Inc.	T-FDEXRU2-20N-PS-HG	Explorer Utility Height 2 Drawer	\$2,345.00	\$2,008.31
336320	TruckVault Inc.	T-FDEXRU2-20N-PS-LR	Explorer Utility 2 Dwr	\$3,625.00	\$3,104.53
336320	TruckVault Inc.	T-FDEXRU2-20N-PS-LT	Explorer Utility 2 Dwr	\$3,545.00	\$3,036.02
336320	TruckVault Inc.	T-FDEXRU2-20N-PS-P7	Explorer Utility 2 DwrPolice Package; 7" Shorten	\$2,545.00	\$2,179.60
336320	TruckVault Inc.	T-FDEXRU2-20N-PS-PP	Explorer Utility 2 Dwr	\$2,745.00	\$2,350.88
336320	TruckVault Inc.	T-FDEXRU2-20N-PS-PP-HT	Explorer Utility 2 Dwr Pullout Table	\$3,440.00	\$2,946.10
336320	TruckVault Inc.	T-FDEXRU2-20N-PS-PP-LR	Explorer Utility 2 Dwr	\$3,625.00	\$3,104.53
336320	TruckVault Inc.	T-FDEXRU2-20N-PS-PP-LT	Explorer Utility 2 Dwr	\$3,545.00	\$3,036.02

336320	TruckVault Inc.	T-FDEXRU2-20N-PS-ZC9909	Explorer Utility 2 Dwr	\$2,485.00	\$2,128.21
336320	TruckVault Inc.	T-FDEXRU2-20N-ZC9909	Explorer Utility 2 Dwr	\$2,485.00	\$2,128.21
336320	TruckVault Inc.	T-FDEXRU2-20S	Explorer Utility 2 Dwr	\$2,345.00	\$2,008.31
336320	TruckVault Inc.	T-FDEXRUO-11N-PS-LT	Explorer Utility OS Dwr	\$3,340.00	\$2,860.45
336320	TruckVault Inc.	T-FDEXRUO-11N-PS-PP	Explorer Utility Offset Dwr	\$2,745.00	\$2,350.88
336320	TruckVault Inc.	T-FDEXRUO-11N-PS-PP-LT	Explorer Utility Offset Dwr	\$3,340.00	\$2,860.45
336320	TruckVault Inc.	T-FDEXRUO-20N	Explorer Utility Offset Dwr	\$2,745.00	\$2,350.88
336320	TruckVault Inc.	T-FDEXRUO-20N-PS	Explorer Utility Offset Dwr	\$2,745.00	\$2,350.88
336320	TruckVault Inc.	T-FDEXRUO-20N-PS-LT	Explorer Utility OS Dwr	\$3,545.00	\$3,036.02
336320	TruckVault Inc.	T-FDEXRUO-20N-PS-PP	Explorer Utility Offset Dwr	\$2,745.00	\$2,350.88
336320	TruckVault Inc.	T-FDEXRUO-20N-PS-PP-HT	Explorer Utility Offset Dwr Pullout Table Police Package No 3rd Row; P-Cage	\$3,440.00	\$2,946.10
336320	TruckVault Inc.	T-FDEXRUO-20S	Explorer Utility Offset Dwr	\$1,885.00	\$1,614.36
336320	TruckVault Inc.	T-FDEXM1-02N	Ford Explorer Sport Trac Mag 1 Dwr, dimensions: 47L x 40W	\$2,295.00	\$1,965.49
336320	TruckVault Inc.	T-FDEXSM1-07N	Ford Explorer Sport Trac Mag 1 Dwr, dimensions: 47.5L x 42W	\$2,295.00	\$1,965.49
336320	TruckVault Inc.	T-FDEXSM2-02N	Ford Explorer Sport Trac Mag 2 Dwr, dimensions: 47L x 40W	\$2,845.00	\$2,436.52
336320	TruckVault Inc.	T-FDEXSM2-02N-PW	Ford Explorer Sport Trac Mag 2 Dwr, dimensions: 0L x 0W	\$2,845.00	\$2,436.52
336320	TruckVault Inc.	T-FDEXSM2-07N	Ford Explorer Sport Trac Mag 2 Dwr, dimensions: 47.5L x 42W	\$2,845.00	\$2,436.52
336320	TruckVault Inc.	T-FDEXSM2-07N-PW	Ford Explorer Sport Trac Mag 2 Dwr, dimensions: 49.5L x 42W	\$3,095.00	\$2,650.63
336320	TruckVault Inc.	T-FDEXSMO-02N	Ford Explorer Sport Trac Mag Offset, dimensions: 47L x 40W	\$2,845.00	\$2,436.52
336320	TruckVault Inc.	T-FDEXSMO-07N	Ford Explorer Sport Trac Mag Offset, dimensions: 47.5L x 42W	\$2,845.00	\$2,436.52
336320	TruckVault Inc.	T-FDEXSS1-02N	Ford Explorer Sport Trac Std 1 Dwr, dimensions: 47L x 40W	\$2,095.00	\$1,794.21
336320	TruckVault Inc.	T-FDEXSS1-07N	Ford Explorer Sport Trac Std 1 Dwr, dimensions: 47.5L x 42W	\$2,095.00	\$1,794.21
336320	TruckVault Inc.	T-FDEXSS2-02N	Ford Explorer Sport Trac Std 2 Dwr, dimensions: 47L x 40W	\$2,645.00	\$2,265.24
336320	TruckVault Inc.	T-FDEXSS2-02N-PW	Ford Explorer Sport Trac Std 2 Dwr, dimensions: 1L x 1W	\$2,645.00	\$2,265.24
336320	TruckVault Inc.	T-FDEXSS2-07N	Ford Explorer Sport Trac Std 2 Dwr, dimensions: 47.5L x 42W	\$2,645.00	\$2,265.24
336320	TruckVault Inc.	T-FDEXSS2-07N-PW	Ford Explorer Sport Trac Std 2 Dwr, dimensions: 49.5L x 42W	\$3,095.00	\$2,650.63
336320	TruckVault Inc.	T-FDEXSSO-02N	Ford Explorer Sport Trac Std Offset, dimensions: 47L x 40W	\$2,645.00	\$2,265.24
336320	TruckVault Inc.	T-FDEXSSO-07N	Ford Explorer Sport Trac Std Offset, dimensions: 47.5L x 42W	\$2,645.00	\$2,265.24
336320	TruckVault Inc.	T-FDEXSU2-02N-PW	Explorer Sport Trac Utility 2 Dwr	\$3,545.00	\$3,036.02
336320	TruckVault Inc.	T-FDFLXM1-09N	Ford Flex Mag 1 Dwr, dimensions: 39L x 40W	\$2,295.00	\$1,965.49
336320	TruckVault Inc.	T-FDFLXM1-09N-PT	Ford Flex Mag 1 Dwr, dimensions: 38L x 40W	\$2,990.00	\$2,560.71
336320	TruckVault Inc.	T-FDFLXM1-19N-HG	Flex Mag 1 Dwr	\$2,245.00	\$1,922.67
336320	TruckVault Inc.	T-FDFLXM2-09N	Ford Flex Mag 2 Dwr, dimensions: 39L x 40W	\$2,845.00	\$2,436.52
336320	TruckVault Inc.	T-FDFLXM2-09N-PT	Ford Flex Mag 2 Dwr, dimensions: 38L x 40W	\$3,540.00	\$3,031.74
336320	TruckVault Inc.	T-FDFLXMO-09N	Ford Flex Mag Offset, dimensions: 39L x 40W	\$2,845.00	\$2,436.52
336320	TruckVault Inc.	T-FDFLXS1-09N	Ford Flex Std 1 Dwr, dimensions: 41L x 40W	\$2,095.00	\$1,794.21
336320	TruckVault Inc.	T-FDFLXS1-09S	Flex Std 1 Dwr Behind 3rd Row Seat	\$1,695.00	\$1,451.64
336320	TruckVault Inc.	T-FDFLXS1-19N-HG	Flex Std 1 Dwr	\$1,995.00	\$1,708.56
336320	TruckVault Inc.	T-FDFLXS2-09N	Ford Flex Std 2 Dwr, dimensions: 41L x 40W	\$2,645.00	\$2,265.24
336320	TruckVault Inc.	T-FDFLXSO-09N	Ford Flex Std Offset Dwr, dimensions: 41L x 40W	\$2,645.00	\$2,265.24
336320	TruckVault Inc.	T-FDFOCM1-04N	Focus 5-Door Mag 1 Dwr	\$2,095.00	\$1,794.21
336320	TruckVault Inc.	T-FDFOCM1-11N	Focus 5-Door Mag 1 Dwr	\$1,695.00	\$1,451.64
336320	TruckVault Inc.	T-FDFOCN1-11N-HG	Focus 5-Door	\$1,695.00	\$1,451.64
336320	TruckVault Inc.	T-FDFOC1-11N	Focus 5-Door Std 1 Dwr	\$1,495.00	\$1,280.35
336320	TruckVault Inc.	T-FDFREM1-05N	Ford Freestyle Mag 1 Dwr, dimensions: 44L x 40W	\$2,295.00	\$1,965.49
336320	TruckVault Inc.	T-FDFREM2-05N	Ford Freestyle Mag 2 Dwr, dimensions: 0L x 0W	\$2,845.00	\$2,436.52
336320	TruckVault Inc.	T-FDFRES1-05N	Ford Freestyle Std 1 Dwr, dimensions: 0L x 0W	\$2,095.00	\$1,794.21
336320	TruckVault Inc.	T-FDFRES2-05N	Ford Freestyle Std 2 Dwr, dimensions: 44L x 40W	\$2,645.00	\$2,265.24
336320	TruckVault Inc.	T-FDFRSM1-04N	Ford Freestar Mag 1 Dwr, dimensions: 46L x 41.25W	\$2,295.00	\$1,965.49
336320	TruckVault Inc.	T-FDFRSM2-04N	Ford Freestar Mag 2 Dwr, dimensions: 46L x 41.25W	\$2,845.00	\$2,436.52
336320	TruckVault Inc.	T-FDFRSS1-04N	Ford Freestar Std 1 Dwr, dimensions: 48L x 41.25W	\$2,215.00	\$1,896.98
336320	TruckVault Inc.	T-FDFRSS2-04N	Ford Freestar Std 2 Dwr, dimensions: 48L x 41.25W	\$2,755.00	\$2,359.45
336320	TruckVault Inc.	T-FDFRSSO-04N	Ford Freestar Std OS Dwr, dimensions: 48L x 41.25W	\$2,755.00	\$2,359.45
336320	TruckVault Inc.	T-FDFSEM1-04L-HD	Ford F-Series Mag 1 Dwr Half Width, dimensions: 93.25L x 24W	\$2,655.00	\$2,273.80
336320	TruckVault Inc.	T-FDFSEM1-04L-HD-PW	Ford F-Series Mag 1 Dwr Half Width, dimensions: 96L x 24W	\$3,245.00	\$2,779.09
336320	TruckVault Inc.	T-FDFSEM1-04L-HP	Ford F-Series Mag 1 Dwr Half Width, dimensions: 93.25L x 24W	\$2,655.00	\$2,273.80
336320	TruckVault Inc.	T-FDFSEM1-04L-HP-PW	Ford F-Series Mag 1 Dwr Half Width, dimensions: 96L x 24W	\$3,245.00	\$2,779.09
336320	TruckVault Inc.	T-FDFSEM1-04S-HD	Ford F-Series Mag 1 Dwr Half Width, dimensions: 75.5L x 24W	\$2,545.00	\$2,179.60
336320	TruckVault Inc.	T-FDFSEM1-04S-HD-PW	Ford F-Series Mag 1 Dwr Half Width, dimensions: 63L x 49.25W	\$3,045.00	\$2,607.81
336320	TruckVault Inc.	T-FDFSEM1-04S-HP-PW	Ford F-Series Mag 1 Dwr Half Width, dimensions: 63L x 49.25W	\$3,045.00	\$2,607.81
336320	TruckVault Inc.	T-FDFSEM1-04S-PC-HD-PW	Ford F-Series Mag 1 Dwr Half Width, dimensions: 65L x 24W	\$2,745.00	\$2,350.88
336320	TruckVault Inc.	T-FDFSEM1-04S-PC-HD-ZC10156	F-Series Mag 1 Dwr Half Width 5' 6" S-Crew; Driver's Side	\$2,115.00	\$1,811.34
336320	TruckVault Inc.	T-FDFSEM1-04S-PC-HP-PW	Ford F-Series Mag 1 Dwr Half Width, dimensions: 65L x 24W	\$2,745.00	\$2,350.88
336320	TruckVault Inc.	T-FDFSEM1-09L-PF-HD	Ford F-Series Mag 1 Dwr Half Width, dimensions: 0L x 0W	\$2,655.00	\$2,273.80

336320	TruckVault Inc.	T-DFDSEM1-09L-PF-HD-PW	Ford F-Series Mag 1 Dwr Half Width, dimensions: 96L x 24W	\$3,245.00	\$2,779.09
336320	TruckVault Inc.	T-DFDSEM1-09L-PF-HP	Ford F-Series Mag 1 Dwr Half Width, dimensions: 0L x 0W	\$2,655.00	\$2,273.80
336320	TruckVault Inc.	T-DFDSEM1-09L-PF-HP-PW	Ford F-Series Mag 1 Dwr Half Width, dimensions: 96L x 24W	\$3,245.00	\$2,779.09
336320	TruckVault Inc.	T-DFDSEM1-09S-HD-ZC10141	F-Series Mag 1 Dwr Half WidthC10141	\$2,015.00	\$1,725.69
336320	TruckVault Inc.	T-DFDSEM1-09S-PC-PF-HD	Ford F-Series Mag 1 Dwr Half Width, dimensions: 63L x 24W	\$2,495.00	\$2,136.78
336320	TruckVault Inc.	T-DFDSEM1-09S-PC-PF-HD-PW	Ford F-Series Mag 1 Dwr Half Width, dimensions: 63L x 24W	\$2,745.00	\$2,350.88
336320	TruckVault Inc.	T-DFDSEM1-09S-PC-PF-HP	Ford F-Series Mag 1 Dwr, dimensions: 63L x 24W	\$2,495.00	\$2,136.78
336320	TruckVault Inc.	T-DFDSEM1-09S-PC-PF-HP-PW	Ford F-Series Mag 1 Dwr Half Width, dimensions: 63L x 24W	\$2,745.00	\$2,350.88
336320	TruckVault Inc.	T-DFDSEM1-09S-PF-HD	Ford F-Series Mag 1 Dwr Half Width, dimensions: 72.5L x 48W	\$2,545.00	\$2,179.60
336320	TruckVault Inc.	T-DFDSEM1-09S-PF-HD-PW	Ford F-Series Mag 1 Dwr Half Width, dimensions: 75L x 25.25W	\$3,045.00	\$2,607.81
336320	TruckVault Inc.	T-DFDSEM1-09S-PF-HP	Ford F-Series Mag 1 Dwr Half Width, dimensions: 72.5L x 48W	\$2,545.00	\$2,179.60
336320	TruckVault Inc.	T-DFDSEM1-09S-PF-HP-PW	Ford F-Series Mag 1 Dwr Half Width, dimensions: 63L x 49.25W	\$3,045.00	\$2,607.81
336320	TruckVault Inc.	T-DFDSEM1-12L-P5-HD	Ford F-Series Mag 1 Dwr Half Width, dimensions: 94.25L x 24W	\$2,655.00	\$2,273.80
336320	TruckVault Inc.	T-DFDSEM1-12L-P5-HP-PW	Ford F-Series Mag 1 Dwr Half Width, dimensions: 96L x 25.25W	\$3,245.00	\$2,779.09
336320	TruckVault Inc.	T-DFDSEM1-12L-P5-PF-HD	F-Series Mag 1 Dwr Half Width	\$2,655.00	\$2,273.80
336320	TruckVault Inc.	T-DFDSEM1-12L-P5-PF-HD-PW	F-Series Mag 1 Dwr Half Width	\$3,245.00	\$2,779.09
336320	TruckVault Inc.	T-DFDSEM1-12S-P5-HD	Ford F-Series Mag 1 Dwr Half Width, dimensions: 79L x 24W	\$2,545.00	\$2,179.60
336320	TruckVault Inc.	T-DFDSEM1-12S-P5-HD-PW	F-Series Mag 1 Dwr Half Width	\$3,045.00	\$2,607.81
336320	TruckVault Inc.	T-DFDSEM1-12S-P5-HP	Ford F-Series Mag 1 Dwr Half Width, dimensions: 79L x 24W	\$2,545.00	\$2,179.60
336320	TruckVault Inc.	T-DFDSEM1-12S-P5-PF-HD	Ford F-Series Mag 1 Dwr Half Width, dimensions: 76.5L x 24W	\$2,545.00	\$2,179.60
336320	TruckVault Inc.	T-DFDSEM1-12S-P5-PF-HD-PW	Ford F-Series Mag 1 Dwr Half Width, dimensions: 79L x 24W	\$3,045.00	\$2,607.81
336320	TruckVault Inc.	T-DFDSEM1-12S-P5-PF-HP	F-Series Mag 1 Dwr Half Width	\$2,545.00	\$2,179.60
336320	TruckVault Inc.	T-DFDSEM1-12S-P5-PF-HP-PW	F-Series Mag 1 Dwr Half Width	\$3,045.00	\$2,607.81
336320	TruckVault Inc.	T-DFDSEM1-15L-HD	F-Series Mag 1 Dwr Half Width	\$2,655.00	\$2,273.80
336320	TruckVault Inc.	T-DFDSEM1-15L-HD-PW	F-Series Mag 1 Dwr Half Width	\$3,245.00	\$2,779.09
336320	TruckVault Inc.	T-DFDSEM1-15S-HD	Ford F-Series Mag 1 Dwr Half Width, dimensions: 75.5L x 34W	\$2,545.00	\$2,179.60
336320	TruckVault Inc.	T-DFDSEM1-15S-HD-PW	F-Series Mag 1 Dwr Half Width	\$3,045.00	\$2,607.81
336320	TruckVault Inc.	T-DFDSEM1-15S-HP	F-Series Mag 1 Dwr Half Width	\$2,545.00	\$2,179.60
336320	TruckVault Inc.	T-DFDSEM1-15S-HP-PW	Ford F-Series Mag 1 Dwr Half Width, dimensions: 77.5L x 24W	\$3,045.00	\$2,607.81
336320	TruckVault Inc.	T-DFDSEM1-15S-PC-HD-PW	Ford F-Series Mag 1 Dwr Half Width, dimensions: 63L x 49.25W	\$2,745.00	\$2,350.88
336320	TruckVault Inc.	T-DFDSEM1-15S-PC-HD-RX	F-Series Mag 1 Dwr Half Width5' 6" S-Crew; Drivers Side ReTrax	\$2,215.00	\$1,896.98
336320	TruckVault Inc.	T-DFDSEM1-15S-PC-HD-RX-PW	F-Series Mag 1 Dwr Half Width ReTrax5' 6" Crew, All Wthr; Drivers Side	\$2,545.00	\$2,179.60
336320	TruckVault Inc.	T-DFDSEM1-15S-PC-HP-PW	F-Series Mag 1 Dwr Half Width	\$2,745.00	\$2,350.88
336320	TruckVault Inc.	T-DFDSEM1-15S-PC-HP-PW-ZC10286	F-Series Mag 1 Dwr Cust5' 6", A-Wthr, C10286	\$2,585.00	\$2,213.85
336320	TruckVault Inc.	T-DFDSEM1-15S-PC-HP-RX	F-Series Mag 1 Dwr Half Width5' 6" S-Crew; Pass Side, ReTrax	\$2,215.00	\$1,896.98
336320	TruckVault Inc.	T-DFDSEM1-15S-PC-HP-RX-PW	F-Series Mag 1 Dwr Half Width ReTrax5' 6" Crew, All Wthr; PassengerSide	\$2,545.00	\$2,179.60
336320	TruckVault Inc.	T-DFDSEM1-15S-PC-PW-ZC7929	F-Series Mag 1 Dwr Cust	\$3,155.00	\$2,702.02
336320	TruckVault Inc.	T-DFDSEM1-15S-PC-RX-HP-ZC11587	F-Series Mag 1 Dwr	\$2,025.00	\$1,734.26
336320	TruckVault Inc.	T-DFDSEM1-15S-PC-ZC8645	F-Series Mag 1 Dwr	\$2,025.00	\$1,734.26
336320	TruckVault Inc.	T-DFDSEM1-17L-P5-HD-PW	F-Series Mag 1 Dwr Half Width	\$3,245.00	\$2,779.09
336320	TruckVault Inc.	T-DFDSEM1-17L-P5-HP	F-Series Mag 1 Dwr Half Width	\$2,655.00	\$2,273.80
336320	TruckVault Inc.	T-DFDSEM1-17L-P5-HP-PW	F-Series Mag 1 Dwr Half Width	\$3,245.00	\$2,779.09
336320	TruckVault Inc.	T-DFDSEM1-17L-P5-HP-PW-ZC10035	F-Series Mag 1 Dwr Half Width	\$3,235.00	\$2,770.53
336320	TruckVault Inc.	T-DFDSEM1-17S-P5-HD	F-Series Mag 1 Dwr Half Width	\$2,695.00	\$2,308.06
336320	TruckVault Inc.	T-DFDSEM1-17S-P5-HD-PW	F-Series Mag 1 Dwr Half Width	\$3,045.00	\$2,607.81
336320	TruckVault Inc.	T-DFDSEM1-17S-P5-HP	F-Series Mag 1 Dwr Half Width	\$2,545.00	\$2,179.60
336320	TruckVault Inc.	T-DFDSEM1-17S-P5-HP-PW	F-Series Mag 1 Dwr Half Width	\$3,045.00	\$2,607.81
336320	TruckVault Inc.	T-DFDSEM1-17S-P5-HP-PW-ZC9123	F-Series Mag 1 Dwr Half Width Custom	\$2,935.00	\$2,513.60
336320	TruckVault Inc.	T-DFDSEM1-97S-P5-HD-PW	F-Series Mag 1 Dwr Half Width	\$3,045.00	\$2,607.81
336320	TruckVault Inc.	T-DFDSEM1-97S-P5-HP	Ford F-Series Mag 1 Dwr Half Width, dimensions: 80L x 24W	\$2,545.00	\$2,179.60
336320	TruckVault Inc.	T-DFDSEM1-97S-P5-HP-PW	Ford F-Series Mag 1 Dwr Half Width, dimensions: 82L x 24W	\$3,045.00	\$2,607.81
336320	TruckVault Inc.	T-DFDSEM2-01S-PC	Ford F-Series Pickup Mag 2 Dwr, dimensions: 63L x 53W	\$3,545.00	\$3,036.02
336320	TruckVault Inc.	T-DFDSEM2-01S-PC-PW	Ford F-Series Pickup Mag 2 Dwr, dimensions: 0L x 0W	\$3,545.00	\$3,036.02
336320	TruckVault Inc.	T-DFDSEM2-04L	Ford F-Series Pickup Mag 2 Dwr, dimensions: 93.5L x 48W	\$3,945.00	\$3,378.59
336320	TruckVault Inc.	T-DFDSEM2-04L-PT	Ford F-Series Pickup Mag 2 Dwr, dimensions: 74L x 48W	\$4,440.00	\$3,802.52
336320	TruckVault Inc.	T-DFDSEM2-04L-PW	Ford F-Series Pickup Mag 2 Dwr, dimensions: 96L x 48W	\$4,945.00	\$4,235.01
336320	TruckVault Inc.	T-DFDSEM2-04S	Ford F-Series Pickup Mag 2 Dwr, dimensions: 75L x 48W	\$3,745.00	\$3,207.30
336320	TruckVault Inc.	T-DFDSEM2-04S-HT-PW	F-Series Pickup Mag 2 Dwr	\$5,340.00	\$4,573.30
336320	TruckVault Inc.	T-DFDSEM2-04S-PC	Ford F-Series Pickup Mag 2 Dwr, dimensions: 63L x 48W	\$3,545.00	\$3,036.02
336320	TruckVault Inc.	T-DFDSEM2-04S-PC-PT	Ford F-Series Pickup Mag 2 Dwr, dimensions: 63L x 48W	\$4,240.00	\$3,631.23
336320	TruckVault Inc.	T-DFDSEM2-04S-PC-PW	Ford F-Series Pickup Mag 2 Dwr, dimensions: 65L x 48W	\$4,345.00	\$3,721.16

336320	TruckVault Inc.	T-FDFSEM2-04S-PT	Ford F-Series Pickup Mag 2 Dwr, dimensions: 75.5L x 48W	\$4,440.00	\$3,802.52
336320	TruckVault Inc.	T-FDFSEM2-04S-PW	Ford F-Series Pickup Mag 2 Dwr, dimensions: 76.5L x 48W	\$4,645.00	\$3,978.09
336320	TruckVault Inc.	T-FDFSEM2-09L-PF	Ford F-Series Pickup Mag 2 Dwr, dimensions: 90.25L x 48W	\$3,945.00	\$3,378.59
336320	TruckVault Inc.	T-FDFSEM2-09L-PF-PW	Ford F-Series Pickup Mag 2 Dwr, dimensions: 96L x 48W	\$4,945.00	\$4,235.01
336320	TruckVault Inc.	T-FDFSEM2-09S-PC-PF	Ford F-Series Pickup Mag 2 Dwr, dimensions: 62L x 48W	\$3,545.00	\$3,036.02
336320	TruckVault Inc.	T-FDFSEM2-09S-PC-PF-PW	Ford F-Series Pickup Mag 2 Dwr, dimensions: 63L x 53W	\$4,345.00	\$3,721.16
336320	TruckVault Inc.	T-FDFSEM2-09S-PF	Ford F-Series Pickup Mag 2 Dwr, dimensions: 74L x 48W	\$3,745.00	\$3,207.30
336320	TruckVault Inc.	T-FDFSEM2-09S-PF-PW	Ford F-Series Pickup Mag 2 Dwr, dimensions: 75L x 48W	\$4,645.00	\$3,978.09
336320	TruckVault Inc.	T-FDFSEM2-12L-P5	Ford F-Series Pickup Mag 2 Dwr, dimensions: 93.5L x 48W	\$3,945.00	\$3,378.59
336320	TruckVault Inc.	T-FDFSEM2-12L-P5-PF	Ford F-Series Pickup Mag 2 Dwr, dimensions: 93L x 48W	\$3,945.00	\$3,378.59
336320	TruckVault Inc.	T-FDFSEM2-12L-P5-PF-PW	Ford F-Series Pickup Mag 2 Dwr, dimensions: 94L x 48W	\$4,945.00	\$4,235.01
336320	TruckVault Inc.	T-FDFSEM2-12L-P5-PW	Ford F-Series Pickup Mag 2 Dwr, dimensions: 96L x 48W	\$4,945.00	\$4,235.01
336320	TruckVault Inc.	T-FDFSEM2-12S-P5	Ford F-Series Pickup Mag 2 Dwr, dimensions: 79L x 48W	\$3,745.00	\$3,207.30
336320	TruckVault Inc.	T-FDFSEM2-12S-P5-HT	Ford F-Series Pickup Mag 2 Dwr, dimensions: 77L x 48W	\$4,440.00	\$3,802.52
336320	TruckVault Inc.	T-FDFSEM2-12S-P5-PF	Ford F-Series Pickup Mag 2 Dwr, dimensions: 77.5L x 48W	\$3,745.00	\$3,207.30
336320	TruckVault Inc.	T-FDFSEM2-12S-P5-PF-PW	Ford F-Series Pickup Mag 2 Dwr, dimensions: 78L x 48W	\$4,645.00	\$3,978.09
336320	TruckVault Inc.	T-FDFSEM2-12S-P5-PW	Ford F-Series Pickup Mag 2 Dwr, dimensions: 80L x 48W	\$4,645.00	\$3,978.09
336320	TruckVault Inc.	T-FDFSEM2-12S-P5-PW-HT-Z1	F-Series Pickup AW Mag 2 Dwr	\$5,785.00	\$4,954.41
336320	TruckVault Inc.	T-FDFSEM2-15L	Ford F-Series Pickup Mag 2 Dwr, dimensions: 94.5L x 50.5W	\$3,945.00	\$3,378.59
336320	TruckVault Inc.	T-FDFSEM2-15L-PW	F-Series Pickup Mag 2 Dwr	\$4,945.00	\$4,235.01
336320	TruckVault Inc.	T-FDFSEM2-15L-ZC8193	F-Series Pickup Mag 2 Dwr	\$3,275.00	\$2,804.79
336320	TruckVault Inc.	T-FDFSEM2-15S	Ford F-Series Pickup Mag 2 Dwr, dimensions: 75.5L x 48W	\$3,745.00	\$3,207.30
336320	TruckVault Inc.	T-FDFSEM2-15S-HT-PW	F-Series Pickup Mag 2 Dwr	\$5,340.00	\$4,573.30
336320	TruckVault Inc.	T-FDFSEM2-15S-PC	Ford F-Series Pickup Mag 2 Dwr, dimensions: 63L x 48W	\$3,545.00	\$3,036.02
336320	TruckVault Inc.	T-FDFSEM2-15S-PC-HT	F-Series Pickup Mag 2 Dwr	\$4,040.00	\$3,459.95
336320	TruckVault Inc.	T-FDFSEM2-15S-PC-HT-PW	F-Series Pickup Mag 2 Dwr	\$5,040.00	\$4,316.37
336320	TruckVault Inc.	T-FDFSEM2-15S-PC-PT	Ford F-Series Pickup Mag 2 Dwr, dimensions: 64L x 53W	\$4,240.00	\$3,631.23
336320	TruckVault Inc.	T-FDFSEM2-15S-PC-PW	Ford F-Series Pickup Mag 2 Dwr, dimensions: 65.5L x 53W	\$4,345.00	\$3,721.16
336320	TruckVault Inc.	T-FDFSEM2-15S-PC-PW-ZC8823	F-Series Pickup Mag 2 Dwr	\$3,275.00	\$2,804.79
336320	TruckVault Inc.	T-FDFSEM2-15S-PC-PW-ZC9208	F-Series Pickup Mag 2 Dwr Custom	\$4,065.00	\$3,481.36
336320	TruckVault Inc.	T-FDFSEM2-15S-PC-RX	F-Series Pickup Mag 2 Dwr5' 6" S-Crew; Retrax	\$3,345.00	\$2,864.74
336320	TruckVault Inc.	T-FDFSEM2-15S-PC-RX-PW	F-Series Pickup Mag 2 Dwr5' 6" S-Crew, All Weather; Retrax	\$4,045.00	\$3,464.23
336320	TruckVault Inc.	T-FDFSEM2-15S-PC-ZC10301	F-Series Pickup Mag 2 Dwr5' 6" S-Crew; C10301	\$3,485.00	\$2,984.63
336320	TruckVault Inc.	T-FDFSEM2-15S-PC-ZC8154	F-Series Pickup Mag 2 Dwr	\$3,505.00	\$3,001.76
336320	TruckVault Inc.	T-FDFSEM2-15S-PC-ZC8823	F-Series Pickup Mag 2 Dwr	\$3,275.00	\$2,804.79
336320	TruckVault Inc.	T-FDFSEM2-15S-PC-ZC9174	F-Series Pickup Mag 2 Dwr	\$3,275.00	\$2,804.79
336320	TruckVault Inc.	T-FDFSEM2-15S-PW	Ford F-Series Pickup Mag 2 Dwr, dimensions: 77.5L x 48W	\$4,645.00	\$3,978.09
336320	TruckVault Inc.	T-FDFSEM2-15S-ZC8188	F-Series Pickup Mag 2 Dwr	\$3,275.00	\$2,804.79
336320	TruckVault Inc.	T-FDFSEM2-17L-P5	F-Series Pickup Mag 2 Dwr	\$3,945.00	\$3,378.59
336320	TruckVault Inc.	T-FDFSEM2-17L-P5-PW	F-Series Pickup Mag 2 Dwr	\$4,945.00	\$4,235.01
336320	TruckVault Inc.	T-FDFSEM2-17L-P5-PW-RX	F-Series Pickup Mag 2 Dwr ReTrax	\$4,645.00	\$3,978.09
336320	TruckVault Inc.	T-FDFSEM2-17L-P5-PW-ZC9509	F-Series Pickup Mag 2 Dwr	\$4,285.00	\$3,669.77
336320	TruckVault Inc.	T-FDFSEM2-17N-P5-HT-PW-ZC10318	Ford F250 Pickup Mag OS DwrA/W, Custom HD Table w/ map board, C10318	\$6,265.00	\$5,365.49
336320	TruckVault Inc.	T-FDFSEM2-17S-P5	F-Series Pickup Mag 2 Dwr	\$3,745.00	\$3,207.30
336320	TruckVault Inc.	T-FDFSEM2-17S-P5-HT	F-Series Pickup Mag 2 Dwr	\$4,440.00	\$3,802.52
336320	TruckVault Inc.	T-FDFSEM2-17S-P5-PW	F-Series Pickup Mag 2 Dwr	\$4,645.00	\$3,978.09
336320	TruckVault Inc.	T-FDFSEM2-17S-P5-PW-ZC8550	F-Series Pickup Mag 2 Dwr	\$4,285.00	\$3,669.77
336320	TruckVault Inc.	T-FDFSEM2-17S-P5-PW-ZC8609	F-Series Pickup Mag 2 Dwr	\$4,525.00	\$3,875.31
336320	TruckVault Inc.	T-FDFSEM2-17S-P5-PW-ZC9785	F-Series Pickup Custom Mag 2 DwrC9785	\$3,345.00	\$2,864.74
336320	TruckVault Inc.	T-FDFSEM2-17S-P5-ZC11155	F-Series Pickup Mag 2 DwrC11155	\$3,275.00	\$2,804.79
336320	TruckVault Inc.	T-FDFSEM2-17S-P5-ZC9201	F-Series Pickup Mag 2 Dwr	\$3,055.00	\$2,616.37
336320	TruckVault Inc.	T-FDFSEM2-80L-P5	Ford F-Series Pickup Mag 2 Dwr, dimensions: 0L x 0W	\$3,745.00	\$3,207.30
336320	TruckVault Inc.	T-FDFSEM2-80L-P5-PW	Ford F-Series Pickup Mag 2 Dwr, dimensions: 0L x 0W	\$4,945.00	\$4,235.01
336320	TruckVault Inc.	T-FDFSEM2-87L	Ford F-Series Pickup Mag 2 Dwr, dimensions: 93.25L x 49.25W	\$3,945.00	\$3,378.59
336320	TruckVault Inc.	T-FDFSEM2-87L-PW	F-Series Pickup Mag 2 Dwr	\$4,945.00	\$4,235.01
336320	TruckVault Inc.	T-FDFSEM2-87S	F-Series Pickup Mag 2 Dwr	\$3,745.00	\$3,207.30
336320	TruckVault Inc.	T-FDFSEM2-88L-P5-PW	Ford F-Series Pickup Mag 2 Dwr, dimensions: 0L x 0W	\$4,945.00	\$4,235.01
336320	TruckVault Inc.	T-FDFSEM2-92L-P5	F-Series Pickup Mag 2 Dwr	\$3,945.00	\$3,378.59
336320	TruckVault Inc.	T-FDFSEM2-92L-P5-PW	F-Series Pickup Mag 2 Dwr	\$4,945.00	\$4,235.01
336320	TruckVault Inc.	T-FDFSEM2-97L	Ford F-Series Pickup Mag 2 Dwr, dimensions: 94.5L x 48W	\$3,945.00	\$3,378.59
336320	TruckVault Inc.	T-FDFSEM2-97L-P5	Ford F-Series Pickup Mag 2 Dwr, dimensions: 94.5L x 48W	\$3,945.00	\$3,378.59
336320	TruckVault Inc.	T-FDFSEM2-97L-P5-BS	Ford F-Series Pickup Mag 2 Dwr, dimensions: 61.5L x 49.25W	\$3,245.00	\$2,779.09
336320	TruckVault Inc.	T-FDFSEM2-97L-P5-PF	Ford F-Series Pickup Mag 2 Dwr, dimensions: 95L x 48W	\$3,945.00	\$3,378.59
336320	TruckVault Inc.	T-FDFSEM2-97L-P5-PF-BS	Ford F-Series Pickup Mag 2 Dwr, dimensions: 91L x 48W	\$3,645.00	\$3,121.66
336320	TruckVault Inc.	T-FDFSEM2-97L-P5-PF-PW	Ford F-Series Pickup Mag 2 Dwr, dimensions: 94L x 48W	\$4,945.00	\$4,235.01
336320	TruckVault Inc.	T-FDFSEM2-97L-P5-PT	Ford F-Series Pickup Mag 2 Dwr, dimensions: 95L x 48W	\$4,640.00	\$3,973.80
336320	TruckVault Inc.	T-FDFSEM2-97L-P5-PW	Ford F-Series Pickup Mag 2 Dwr, dimensions: 96L x 48W	\$4,945.00	\$4,235.01
336320	TruckVault Inc.	T-FDFSEM2-97L-PW	Ford F-Series Pickup Mag 2 Dwr, dimensions: 96L x 49.25W	\$4,945.00	\$4,235.01

336320	TruckVault Inc.	T-FDFSEM2-97S	Ford F-Series Pickup Mag 2 Dwr, dimensions: 76.5L x 48W	\$3,745.00	\$3,207.30
336320	TruckVault Inc.	T-FDFSEM2-97S-P5	Ford F-Series Pickup Mag 2 Dwr, dimensions: 80L x 48W	\$3,745.00	\$3,207.30
336320	TruckVault Inc.	T-FDFSEM2-97S-P5-PF	Ford F-Series Pickup Mag 2 Dwr, dimensions: 77.5L x 48W	\$3,745.00	\$3,207.30
336320	TruckVault Inc.	T-FDFSEM2-97S-P5-PF-PW	Ford F-Series Pickup Mag 2 Dwr, dimensions: 79L x 48W	\$4,645.00	\$3,978.09
336320	TruckVault Inc.	T-FDFSEM2-97S-P5-PT	Ford F-Series Pickup Mag 2 Dwr, dimensions: 80L x 48W	\$4,440.00	\$3,802.52
336320	TruckVault Inc.	T-FDFSEM2-97S-P5-PW	Ford F-Series Pickup Mag 2 Dwr, dimensions: 81L x 48W	\$4,645.00	\$3,978.09
336320	TruckVault Inc.	T-FDFSEM2-97S-PC-PW	Ford F-Series Pickup Mag 2 Dwr, dimensions: 65L x 48W	\$4,345.00	\$3,721.16
336320	TruckVault Inc.	T-FDFSEM2-97S-PW	Ford F-Series Pickup Mag 2 Dwr, dimensions: 0L x 0W	\$4,645.00	\$3,978.09
336320	TruckVault Inc.	T-FDFSEM3-12L-P5-C2-PW-ZC9709	F-Series PU CUST Mag 3 Dwr	\$5,445.00	\$4,663.22
336320	TruckVault Inc.	T-FDFSEM3-15S-PC-PW-ZC10706	F-Series Pickup Mag 2 DwrC10706	\$4,745.00	\$4,063.73
336320	TruckVault Inc.	T-FDFSEM3-17L-P5-C2-PW-ZC11679	F-Series Pickup Mag 3 Dwr	\$5,145.00	\$4,406.30
336320	TruckVault Inc.	T-FDFSEM3-17L-P5-C2-PW-ZC9816	F-Series Pickup Mag 3 Dwr	\$5,445.00	\$4,663.22
336320	TruckVault Inc.	T-FDFSEM3-17S-P5-C2-PW-ZC11017	F-Series PU CUST Mag 3 DwrF-250/350, SB, A-Wthr, Gooseneck;	\$5,145.00	\$4,406.30
336320	TruckVault Inc.	T-FDFSEM3-17S-P5-C2-PW-ZC11037	F-Series Mag 3 Dwr shortened for Toll BoxF-250/350, SB, A-Wthr, Gooseneck;	\$4,545.00	\$3,892.44
336320	TruckVault Inc.	T-FDFSEM3-97S-P5-PF-ZC8419	F-Series Pickup Mag 3 Dwr	\$4,755.00	\$4,072.29
336320	TruckVault Inc.	T-FDFSEM0-01S-PC	Ford F-Series Pickup Mag OS Dwr, dimensions: 63L x 53W	\$3,545.00	\$3,036.02
336320	TruckVault Inc.	T-FDFSEM0-01S-PC-PW	Ford F-Series Pickup Mag OS Dwr, dimensions: 65L x 49.25W	\$4,345.00	\$3,721.16
336320	TruckVault Inc.	T-FDFSEM0-04L	Ford F-Series Pickup Mag OS Dwr, dimensions: 94.5L x 48W	\$3,945.00	\$3,378.59
336320	TruckVault Inc.	T-FDFSEM0-04L-PW	Ford F-Series Pickup Mag OS Dwr, dimensions: 0L x 0W	\$4,945.00	\$4,235.01
336320	TruckVault Inc.	T-FDFSEM0-04S	Ford F-Series Pickup Mag Offset Dwr, dimensions: 75L x 48W	\$3,745.00	\$3,207.30
336320	TruckVault Inc.	T-FDFSEM0-04S-PC	Ford F-Series Pickup Mag OS Dwr, dimensions: 64L x 53W	\$3,545.00	\$3,036.02
336320	TruckVault Inc.	T-FDFSEM0-04S-PC-PT	Ford F-Series Pickup Mag OS Dwr, dimensions: 63L x 53W	\$4,240.00	\$3,631.23
336320	TruckVault Inc.	T-FDFSEM0-04S-PC-PW	Ford F-Series Pickup Mag OS Dwr, dimensions: 65L x 53W	\$4,345.00	\$3,721.16
336320	TruckVault Inc.	T-FDFSEM0-04S-PT	Ford F-Series Pickup Mag Offset Dwr, dimensions: 75.5L x 48W	\$4,440.00	\$3,802.52
336320	TruckVault Inc.	T-FDFSEM0-04S-PW	Ford F-Series Pickup Mag Offset Dwr, dimensions: 76.5L x 48W	\$4,645.00	\$3,978.09
336320	TruckVault Inc.	T-FDFSEM0-09L-PF	Ford F-Series Pickup Mag Offset Dwr, dimensions: 90.25L x 48W	\$3,945.00	\$3,378.59
336320	TruckVault Inc.	T-FDFSEM0-09L-PF-PW	Ford F-Series Pickup Mag OS Dwr, dimensions: 96L x 48W	\$4,945.00	\$4,235.01
336320	TruckVault Inc.	T-FDFSEM0-09S-PC-PF	Ford F-Series Pickup Mag Offset Dwr, dimensions: 63L x 48W	\$3,545.00	\$3,036.02
336320	TruckVault Inc.	T-FDFSEM0-09S-PC-PF-PW	Ford F-Series Pickup Mag Offset, dimensions: 63L x 53W	\$4,345.00	\$3,721.16
336320	TruckVault Inc.	T-FDFSEM0-09S-PF	Ford F-Series Pickup Mag Offset Dwr, dimensions: 73L x 48W	\$3,645.00	\$3,121.66
336320	TruckVault Inc.	T-FDFSEM0-09S-PF-PW	Ford F-Series Pickup Mag OS Dwr, dimensions: 75L x 48W	\$4,645.00	\$3,978.09
336320	TruckVault Inc.	T-FDFSEM0-12L-P5	Ford F-Series Pickup Mag OS Dwr, dimensions: 94.5L x 48W	\$3,945.00	\$3,378.59
336320	TruckVault Inc.	T-FDFSEM0-12L-P5-PF	Ford F-Series Pickup Mag Offset Dwr, dimensions: 93L x 48W	\$3,945.00	\$3,378.59
336320	TruckVault Inc.	T-FDFSEM0-12L-P5-PF-PW	Ford F-Series Pickup Mag Offset Dwr, dimensions: 93L x 48W	\$4,945.00	\$4,235.01
336320	TruckVault Inc.	T-FDFSEM0-12L-P5-PW	Ford F-Series Pickup Mag OS Dwr, dimensions: 96L x 48W	\$4,945.00	\$4,235.01
336320	TruckVault Inc.	T-FDFSEM0-12L-P5-ZC9452	F-Series Pickup Mag Offset Dwr	\$2,625.00	\$2,248.11
336320	TruckVault Inc.	T-FDFSEM0-12S-P5	Ford F-Series Pickup Mag OS Dwr, dimensions: 79L x 48W	\$3,745.00	\$3,207.30
336320	TruckVault Inc.	T-FDFSEM0-12S-P5-HT-PW	F-Series Pickup Mag OS Dwr	\$5,340.00	\$4,573.30
336320	TruckVault Inc.	T-FDFSEM0-12S-P5-PF	Ford F-Series Pickup Mag Offset Dwr, dimensions: 76.5L x 48W	\$3,745.00	\$3,207.30
336320	TruckVault Inc.	T-FDFSEM0-12S-P5-PF-PW	Ford F-Series Pickup Mag Offset Dwr, dimensions: 78L x 48W	\$4,645.00	\$3,978.09
336320	TruckVault Inc.	T-FDFSEM0-12S-P5-PW	Ford F-Series Pickup Mag OS Dwr, dimensions: 80L x 48W	\$4,645.00	\$3,978.09
336320	TruckVault Inc.	T-FDFSEM0-15L	F-Series Pickup Mag Offset Dwr	\$3,945.00	\$3,378.59
336320	TruckVault Inc.	T-FDFSEM0-15L-PW	F-Series Pickup Mag OS Dwr	\$4,945.00	\$4,235.01
336320	TruckVault Inc.	T-FDFSEM0-15L-ZC11095	F-Series Pickup Mag Offset DwrC11095	\$3,275.00	\$2,804.79
336320	TruckVault Inc.	T-FDFSEM0-15S	Ford F-Series Pickup Mag Offset Dwr, dimensions: 76.5L x 48W	\$3,745.00	\$3,207.30
336320	TruckVault Inc.	T-FDFSEM0-15S-PC	Ford F-Series Pickup Mag OS Dwr, dimensions: 64L x 53W	\$3,545.00	\$3,036.02
336320	TruckVault Inc.	T-FDFSEM0-15S-PC-HT	F-Series Pickup Mag OS Dwr	\$4,040.00	\$3,459.95
336320	TruckVault Inc.	T-FDFSEM0-15S-PC-PW	Ford F-Series Pickup Mag OS Dwr, dimensions: 65.5L x 53W	\$4,345.00	\$3,721.16
336320	TruckVault Inc.	T-FDFSEM0-15S-PC-PW-Z3	F-Series Pickup Mag OS Dwr	\$4,425.00	\$3,789.67
336320	TruckVault Inc.	T-FDFSEM0-15S-PC-PW-ZC9208	F-Series Pickup Mag 2 Dwr Offset	\$4,065.00	\$3,481.36
336320	TruckVault Inc.	T-FDFSEM0-15S-PC-RX	F-Series Pickup Mag OS Dwr5' 6" S-Crew ReTrax	\$3,345.00	\$2,864.74
336320	TruckVault Inc.	T-FDFSEM0-15S-PC-RX-PW	F-Series Pickup Mag Offset Dwr ReTrax5' 6" SB, Crew Cab, All-Whtr	\$4,045.00	\$3,464.23
336320	TruckVault Inc.	T-FDFSEM0-15S-PC-ZC10213	F-Series Pickup Mag Offset CustomC10213	\$3,275.00	\$2,804.79
336320	TruckVault Inc.	T-FDFSEM0-15S-PW	Ford F-Series Pickup Mag Offset Dwr, dimensions: 77.5L x 48W	\$4,645.00	\$3,978.09
336320	TruckVault Inc.	T-FDFSEM0-17L-P5	F-Series Pickup Mag OS Dwr	\$3,945.00	\$3,378.59
336320	TruckVault Inc.	T-FDFSEM0-17L-P5-HT	F-Series Pickup Mag OS Dwr8' Bed F-250/350; Heavy Duty Table	\$4,640.00	\$3,973.80
336320	TruckVault Inc.	T-FDFSEM0-17L-P5-PW	F-Series Pickup Mag OS Dwr	\$4,945.00	\$4,235.01
336320	TruckVault Inc.	T-FDFSEM0-17S-P5	F-Series Pickup Mag OS Dwr	\$3,745.00	\$3,207.30
336320	TruckVault Inc.	T-FDFSEM0-17S-P5-HT	F-Series Pickup Mag OS Dwr	\$4,440.00	\$3,802.52

336320	TruckVault Inc.	T-DFDSEMO-17S-P5-PW	F-Series Pickup Mag OS Dwr	\$4,645.00	\$3,978.09
336320	TruckVault Inc.	T-DFDSEMO-17S-P5-PW-ZC8550	F-Series Pickup Mag Offset Dwr	\$4,285.00	\$3,669.77
336320	TruckVault Inc.	T-DFDSEMO-17S-P5-PW-ZC8950	F-Series Pickup Mag OS Dwr	\$5,085.00	\$4,354.91
336320	TruckVault Inc.	T-DFDSEMO-17S-P5-PW-ZC8998	F-Series Pickup Mag Offset Dwr	\$5,085.00	\$4,354.91
336320	TruckVault Inc.	T-DFDSEMO-88L-P5	Ford F-Series Pickup Mag OS Dwr, dimensions: 0L x 0W	\$3,745.00	\$3,207.30
336320	TruckVault Inc.	T-DFDSEMO-88L-P5-PW	Ford F-Series Pickup Mag OS Dwr, dimensions: 0L x 0W	\$4,645.00	\$3,978.09
336320	TruckVault Inc.	T-DFDSEMO-92L-P5-PW	F-Series Pickup Mag OS Dwr8' Bed F-250/350, All-Wthr	\$4,945.00	\$4,235.01
336320	TruckVault Inc.	T-DFDSEMO-97L	Ford F-Series Pickup Mag Offset Dwr, dimensions: 93.25L x 48W	\$3,945.00	\$3,378.59
336320	TruckVault Inc.	T-DFDSEMO-97L-P5	Ford F-Series Pickup Mag OS Dwr, dimensions: 94.5L x 48W	\$3,945.00	\$3,378.59
336320	TruckVault Inc.	T-DFDSEMO-97L-P5-PT	Ford F-Series Pickup Mag OS Dwr, dimensions: 95.375L x 48W	\$4,640.00	\$3,973.80
336320	TruckVault Inc.	T-DFDSEMO-97L-P5-PW	Ford F-Series Pickup Mag OS Dwr, dimensions: 96L x 48W	\$4,945.00	\$4,235.01
336320	TruckVault Inc.	T-DFDSEMO-97L-P5-ZC10682B	F-Series CustomC10682B	\$3,795.00	\$3,250.13
336320	TruckVault Inc.	T-DFDSEMO-97L-PW	F-Series Pickup Mag 2 Dwr Offset	\$4,945.00	\$4,235.01
336320	TruckVault Inc.	T-DFDSEMO-97S	Ford F-Series Pickup Mag OS Dwr, dimensions: 76.5L x 48W	\$3,745.00	\$3,207.30
336320	TruckVault Inc.	T-DFDSEMO-97S-P5	Ford F-Series Pickup Mag OS Dwr, dimensions: 80L x 48W	\$3,745.00	\$3,207.30
336320	TruckVault Inc.	T-DFDSEMO-97S-P5-PF	Ford F-Series Pickup Mag Offset Dwr, dimensions: 78.75L x 50.5W	\$3,745.00	\$3,207.30
336320	TruckVault Inc.	T-DFDSEMO-97S-P5-PF-PW	Ford F-Series Pickup Mag Offset Dwr, dimensions: 79L x 48W	\$4,645.00	\$3,978.09
336320	TruckVault Inc.	T-DFDSEMO-97S-P5-PT	Ford F-Series Pickup Mag Offset Dwr, dimensions: 80.1875L x 48W	\$4,440.00	\$3,802.52
336320	TruckVault Inc.	T-DFDSEMO-97S-P5-PW	Ford F-Series Pickup Mag OS Dwr, dimensions: 81L x 48W	\$4,645.00	\$3,978.09
336320	TruckVault Inc.	T-DFDSEMO-97S-PT	Ford F-Series Pickup Mag OS Dwr, dimensions: 76.5L x 48W	\$4,440.00	\$3,802.52
336320	TruckVault Inc.	T-DFDSEMO-97S-PW	Ford F-Series Pickup Mag OS Dwr, dimensions: 0L x 0W	\$4,645.00	\$3,978.09
336320	TruckVault Inc.	T-DFDSENO-15S-C2-ZC8668	F-Series CUST	\$2,225.00	\$1,905.54
336320	TruckVault Inc.	T-DFDSEN1-15S-PC-HD-PW-ZC8454	F-Series Cust 1 Dwr Half Width	\$3,215.00	\$2,753.40
336320	TruckVault Inc.	T-DFDSEN1-15S-PC-HP-ZC9713	F-Series Cust 1 Dwr	\$2,255.00	\$1,931.23
336320	TruckVault Inc.	T-DFDSEN1-15S-PC-ZC8452	F-Series Cust 1 Dwr	\$1,575.00	\$1,348.87
336320	TruckVault Inc.	T-DFDSEN1-15S-PC-ZC9713	F-Series Cust 1 Dwr	\$2,255.00	\$1,931.23
336320	TruckVault Inc.	T-DFDSEN1-15S-PC-ZC9991	F-Series Custom 1 DwrC9991	\$2,635.00	\$2,256.68
336320	TruckVault Inc.	T-DFDSEN1-17S-P5-HP-PW-ZC10411	F-Series Cust 1 Dwr Half Width	\$3,875.00	\$3,318.64
336320	TruckVault Inc.	T-DFDSEN1-17S-P5-HP-ZC10982	F-Series Cust 1 Dwr Half WidthC10982	\$2,535.00	\$2,171.03
336320	TruckVault Inc.	T-DFDSEN1-17S-P5-HP-ZC8840	F-Series Cust 1 Dwr Half Width	\$2,765.00	\$2,368.01
336320	TruckVault Inc.	T-DFDSEN2-12S-P5-PW-ZC9106	F-Series Pickup Cust 2 Dwr	\$5,835.00	\$4,997.23
336320	TruckVault Inc.	T-DFDSEN2-15S-PC-C1-PW-ZC11351	F-Series Pickup Custom 2 Dwr	\$4,845.00	\$4,149.37
336320	TruckVault Inc.	T-DFDSEN2-15S-PC-HP-ZC8602	F-Series Pickup CUSTOM 2 Dwr	\$3,785.00	\$3,241.56
336320	TruckVault Inc.	T-DFDSEN2-15S-PC-PW-ZC11698	F-Series Pickup Custom Height 2 Dwr	\$4,450.00	\$3,811.08
336320	TruckVault Inc.	T-DFDSEN2-15S-PC-PW-ZC8048	F-Series Pickup Cust 2 Dwr	\$4,845.00	\$4,149.37
336320	TruckVault Inc.	T-DFDSEN2-15S-PC-PW-ZC8409	F-Series Pickup Cust 2 Dwr	\$5,315.00	\$4,551.89
336320	TruckVault Inc.	T-DFDSEN2-15S-PC-PW-ZC8773	F-Series Pickup Cust 2 Dwr	\$4,525.00	\$3,875.31
336320	TruckVault Inc.	T-DFDSEN2-15S-PC-RX-ZC10660A	F-Series Pickup 2 Dwr5' 6" Short Bed Shortened for Retrax	\$4,665.00	\$3,995.21
336320	TruckVault Inc.	T-DFDSEN2-15S-PC-ZC10057	F-Series Pickup CUSTOM 2 Dwr	\$3,025.00	\$2,590.68
336320	TruckVault Inc.	T-DFDSEN2-15S-PC-ZC11119	F-Series Pickup Cust 2 DwrC11119	\$3,905.00	\$3,344.33
336320	TruckVault Inc.	T-DFDSEN2-15S-PC-ZC11135	F-Series Pickup Mag 2 Dwr5' 6" S-Crew	\$3,485.00	\$2,984.63
336320	TruckVault Inc.	T-DFDSEN2-15S-PW-ZC8409	F-Series Pickup Cust 2 Dwr	\$5,315.00	\$4,551.89
336320	TruckVault Inc.	T-DFDSEN2-15S-ZC10362	F-Series Pickup Custom 2 Dwr6' 6" Short Bed; C10362	\$3,585.00	\$3,070.28
336320	TruckVault Inc.	T-DFDSEN2-15S-ZC10652A	F-Series Pickup Cust 2 Dwr6' 6" Short Bed; C10652A	\$4,725.00	\$4,046.60
336320	TruckVault Inc.	T-DFDSEN2-15S-ZC7953	F-Series Pickup Cust 2 Dwr	\$3,815.00	\$3,267.25
336320	TruckVault Inc.	T-DFDSEN2-15S-ZC8651	F-Series Pickup Cust 2 Dwr	\$3,835.00	\$3,284.38
336320	TruckVault Inc.	T-DFDSEN2-17L-P5-PW-ZC11266	F-Series Pickup CustomC11266	\$5,585.00	\$4,783.12
336320	TruckVault Inc.	T-DFDSEN2-17L-P5-ZC11686	F-Series Pickup Cust 2 Dwr	\$4,045.00	\$3,464.23
336320	TruckVault Inc.	T-DFDSEN2-17L-P5-ZC6973	F-Series Pickup Cust 2 Dwr	\$4,355.00	\$3,729.72
336320	TruckVault Inc.	T-DFDSEN2-17S-P5-PW-ZC10608	F-Series Pickup CustomC10608	\$4,115.00	\$3,524.18
336320	TruckVault Inc.	T-DFDSEN2-17S-P5-PW-ZC8969	F-Series Pickup CUSTOM 2 Dwr	\$5,205.00	\$4,457.68
336320	TruckVault Inc.	T-DFDSEN2-17S-P5-PW-ZC9317	F-Series Pickup Custom	\$5,255.00	\$4,500.50
336320	TruckVault Inc.	T-DFDSEN2-17S-P5-PW-ZC9819	F-Series Pickup Custom	\$4,855.00	\$4,157.93
336320	TruckVault Inc.	T-DFDSEN2-17S-P5-ZC10021	F-Series Pickup CustomC10021	\$4,495.00	\$3,849.62
336320	TruckVault Inc.	T-DFDSEN2-17S-P5-ZC8926	F-Series Pickup Custom	\$4,125.00	\$3,532.75
336320	TruckVault Inc.	T-DFDSEN3-04R-PC	Ford F-Series Pickup Field Ranger, dimensions: 0L x 0W	\$3,725.00	\$3,190.18
336320	TruckVault Inc.	T-DFDSENO-15S-PC-ZC10638	F-Series Custom	\$3,975.00	\$3,404.28
336320	TruckVault Inc.	T-DFDSENO-17S-P5-PW-ZC9819	F-Series Pickup Custom	\$4,855.00	\$4,157.93
336320	TruckVault Inc.	T-DFDSES1-04L-HD	Ford F-Series Std 1 Dwr Half Width, dimensions: 94.5L x 24W	\$2,435.00	\$2,085.39
336320	TruckVault Inc.	T-DFDSES1-04L-HD-PW	Ford F-Series Std 1 Dwr Half Width, dimensions: 96L x 24W	\$3,045.00	\$2,607.81
336320	TruckVault Inc.	T-DFDSES1-04L-HP	Ford F-Series Std 1 Dwr Half Width, dimensions: 64L x 49.25W	\$2,435.00	\$2,085.39
336320	TruckVault Inc.	T-DFDSES1-04L-HP-PW	Ford F-Series Std 1 Dwr Half Width, dimensions: 63L x 49.25W	\$3,045.00	\$2,607.81
336320	TruckVault Inc.	T-DFDSES1-04S-HD	Ford F-Series Std 1 Dwr Half Width, dimensions: 64L x 49.25W	\$2,325.00	\$1,991.18
336320	TruckVault Inc.	T-DFDSES1-04S-HD-PW	Ford F-Series Std 1 Dwr Half Width, dimensions: 76.5L x 25.25W	\$2,845.00	\$2,436.52

336320	TruckVault Inc.	T-FDFSES1-04S-HP	Ford F-Series Std 1 Dwr Half Width, dimensions: 75L x 24W	\$2,325.00	\$1,991.18
336320	TruckVault Inc.	T-FDFSES1-04S-HP-PW	Ford F-Series Std 1 Dwr Half Width, dimensions: 63L x 49.25W	\$2,845.00	\$2,436.52
336320	TruckVault Inc.	T-FDFSES1-04S-PC-HD-PW	Ford F-Series Std 1 Dwr Half Width, dimensions: 65L x 48W	\$2,545.00	\$2,179.60
336320	TruckVault Inc.	T-FDFSES1-04S-PC-HP-PW	Ford F-Series Std 1 Dwr Half Width, dimensions: 65L x 24W	\$2,545.00	\$2,179.60
336320	TruckVault Inc.	T-FDFSES1-09L-PF-HD	Ford F-Series Std 1 Dwr Half Width, dimensions: 0L x 0W	\$2,435.00	\$2,085.39
336320	TruckVault Inc.	T-FDFSES1-09L-PF-HD-PW	Ford F-Series Std 1 Dwr Half Width, dimensions: 63L x 49.25W	\$3,045.00	\$2,607.81
336320	TruckVault Inc.	T-FDFSES1-09L-PF-HP	Ford F-Series Std 1 Dwr Half Width, dimensions: 0L x 0W	\$2,435.00	\$2,085.39
336320	TruckVault Inc.	T-FDFSES1-09L-PF-HP-PW	Ford F-Series Std 1 Dwr Half Width, dimensions: 63L x 49.25W	\$3,045.00	\$2,607.81
336320	TruckVault Inc.	T-FDFSES1-09S-PC-PF-HD-PW	Ford F-Series Std 1 Dwr Half Width, dimensions: 64L x 24W	\$2,545.00	\$2,179.60
336320	TruckVault Inc.	T-FDFSES1-09S-PC-PF-HP-PW	Ford F-Series Std 1 Dwr Half Width, dimensions: 64L x 24W	\$2,545.00	\$2,179.60
336320	TruckVault Inc.	T-FDFSES1-09S-PF-HD	Ford F-Series Std 1 Dwr Half Width, dimensions: 72.5L x 48W	\$2,325.00	\$1,991.18
336320	TruckVault Inc.	T-FDFSES1-09S-PF-HD-PW	Ford F-Series Std 1 Dwr Half Width, dimensions: 75L x 24W	\$2,845.00	\$2,436.52
336320	TruckVault Inc.	T-FDFSES1-09S-PF-HP	Ford F-Series Std 1 Dwr Half Width, dimensions: 72.5L x 48W	\$2,325.00	\$1,991.18
336320	TruckVault Inc.	T-FDFSES1-09S-PF-HP-PW	Ford F-Series Std 1 Dwr Half Width, dimensions: 63L x 49.25W	\$2,545.00	\$2,179.60
336320	TruckVault Inc.	T-FDFSES1-12S-P5-HP	Ford F-Series Std 1 Dwr Half Width, dimensions: 79L x 24W	\$2,325.00	\$1,991.18
336320	TruckVault Inc.	T-FDFSES1-12S-P5-PF-HD	Ford F-Series Std 1 Dwr Half Width, dimensions: 76.5L x 24W	\$2,325.00	\$1,991.18
336320	TruckVault Inc.	T-FDFSES1-15S-HD	F-Series Std 1 Dwr Half Width	\$2,325.00	\$1,991.18
336320	TruckVault Inc.	T-FDFSES1-15S-HD-PW	F-Series Std 1 Dwr Half Width	\$2,845.00	\$2,436.52
336320	TruckVault Inc.	T-FDFSES1-15S-HP	F-Series Std 1 Dwr Half Width	\$2,325.00	\$1,991.18
336320	TruckVault Inc.	T-FDFSES1-15S-HP-PW	F-Series Std 1 Dwr Half Width	\$2,845.00	\$2,436.52
336320	TruckVault Inc.	T-FDFSES1-15S-PC-HD-PW	F-Series Std 1 Dwr Half Width	\$2,545.00	\$2,179.60
336320	TruckVault Inc.	T-FDFSES1-15S-PC-HP-PW	F-Series Std 1 Dwr Half Width	\$2,545.00	\$2,179.60
336320	TruckVault Inc.	T-FDFSES1-15S-PC-HP-RX-PW	F-Series Mag 1 Dwr Half Width ReTrax5' 6" Crew, All Wthr; Passenger Side	\$2,345.00	\$2,008.31
336320	TruckVault Inc.	T-FDFSES1-15S-PC-ZC8092	F-Series Std 1 Dwr Cust Width	\$1,805.00	\$1,545.84
336320	TruckVault Inc.	T-FDFSES1-15S-PC-ZC8158	F-Series Std 1 Dwr Cust Width	\$1,805.00	\$1,545.84
336320	TruckVault Inc.	T-FDFSES1-15S-PC-ZC8646	F-Series Std 1 Dwr	\$1,805.00	\$1,545.84
336320	TruckVault Inc.	T-FDFSES1-17L-P5-HD-PW	F-Series Std 1 Dwr Half Width	\$3,045.00	\$2,607.81
336320	TruckVault Inc.	T-FDFSES1-17L-P5-HP	F-Series MStd1 Dwr Half Width	\$2,225.00	\$1,905.54
336320	TruckVault Inc.	T-FDFSES1-17L-P5-HP-PW	F-Series Std 1 Dwr Half Width	\$3,045.00	\$2,607.81
336320	TruckVault Inc.	T-FDFSES1-17S-P5-HD	F-Series Std 1 Dwr Half Width	\$2,325.00	\$1,991.18
336320	TruckVault Inc.	T-FDFSES1-17S-P5-HD-PW	F-Series Std 1 Dwr Half Width	\$2,845.00	\$2,436.52
336320	TruckVault Inc.	T-FDFSES1-17S-P5-HP	F-Series Std 1 Dwr Half Width <sup>6</sup> Bed, Passenger Side	\$2,325.00	\$1,991.18
336320	TruckVault Inc.	T-FDFSES1-17S-P5-HP-PW	F-Series Std 1 Dwr Half Width	\$2,845.00	\$2,436.52
336320	TruckVault Inc.	T-FDFSES1-97S-P5-HD-PW	F-Series Std 1 Dwr Half Width	\$2,825.00	\$2,419.40
336320	TruckVault Inc.	T-FDFSES1-97S-P5-HP	F-Series Std 1 Dwr Half Width	\$2,325.00	\$1,991.18
336320	TruckVault Inc.	T-FDFSES1-97S-P5-HP-PW	F-Series Std 1 Dwr Half Width	\$2,325.00	\$1,991.18
336320	TruckVault Inc.	T-FDFSES2-01S-PC	Ford F-Series Pickup Std 2 Dwr, dimensions: 63L x 48W	\$3,345.00	\$2,864.74
336320	TruckVault Inc.	T-FDFSES2-01S-PC-PT	Ford F-Series Pickup Std 2 Dwr, dimensions: 63L x 48W	\$4,040.00	\$3,459.95
336320	TruckVault Inc.	T-FDFSES2-01S-PC-PW	Ford F-Series Pickup Std 2 Dwr, dimensions: 64L x 48W	\$4,145.00	\$3,549.87
336320	TruckVault Inc.	T-FDFSES2-04L	Ford F-Series Pickup Std 2 Dwr, dimensions: 94.5L x 48W	\$3,745.00	\$3,207.30
336320	TruckVault Inc.	T-FDFSES2-04L-HT	F-Series Pickup Std 2 Dwr	\$4,440.00	\$3,802.52
336320	TruckVault Inc.	T-FDFSES2-04L-PW	Ford F-Series Pickup Std 2 Dwr, dimensions: 96L x 48W	\$4,745.00	\$4,063.73
336320	TruckVault Inc.	T-FDFSES2-04S	Ford F-Series Pickup Std 2 Dwr, dimensions: 75L x 48W	\$3,545.00	\$3,036.02
336320	TruckVault Inc.	T-FDFSES2-04S-PC	Ford F-Series Pickup Std 2 Dwr, dimensions: 64L x 48W	\$3,345.00	\$2,864.74
336320	TruckVault Inc.	T-FDFSES2-04S-PC-PT	Ford F-Series Pickup Std 2 Dwr, dimensions: 63L x 48W	\$4,040.00	\$3,459.95
336320	TruckVault Inc.	T-FDFSES2-04S-PC-PW	Ford F-Series Pickup Std 2 Dwr, dimensions: 65L x 48W	\$4,145.00	\$3,549.87
336320	TruckVault Inc.	T-FDFSES2-04S-PT	Ford F-Series Pickup Std 2 Dwr, dimensions: 75.625L x 48W	\$4,240.00	\$3,631.23
336320	TruckVault Inc.	T-FDFSES2-04S-PW	Ford F-Series Pickup Std 2 Dwr, dimensions: 76.5L x 48W	\$4,445.00	\$3,806.80
336320	TruckVault Inc.	T-FDFSES2-09L-PF	Ford F-Series Pickup Std 2 Dwr, dimensions: 90.75L x 48W	\$3,745.00	\$3,207.30
336320	TruckVault Inc.	T-FDFSES2-09L-PF-PW	Ford F-Series Pickup Std 2 Dwr, dimensions: 0L x 0W	\$4,745.00	\$4,063.73
336320	TruckVault Inc.	T-FDFSES2-09S-PC-PF	Ford F-Series Pickup Std 2 Dwr, dimensions: 63L x 48W	\$3,345.00	\$2,864.74
336320	TruckVault Inc.	T-FDFSES2-09S-PC-PF-PT	Ford F-Series Pickup Std 2 Dwr, dimensions: 63L x 48W	\$4,040.00	\$3,459.95
336320	TruckVault Inc.	T-FDFSES2-09S-PC-PF-PW	Ford F-Series Pickup Std 2 Dwr, dimensions: 64L x 48W	\$4,145.00	\$3,549.87
336320	TruckVault Inc.	T-FDFSES2-09S-PF	Ford F-Series Pickup Std 2 Dwr, dimensions: 74L x 48W	\$3,545.00	\$3,036.02
336320	TruckVault Inc.	T-FDFSES2-09S-PF-PW	Ford F-Series Pickup Std 2 Dwr, dimensions: 75L x 48W	\$4,445.00	\$3,806.80
336320	TruckVault Inc.	T-FDFSES2-12L-P5	Ford F-Series Pickup Std 2 Dwr, dimensions: 94.5L x 48W	\$3,745.00	\$3,207.30
336320	TruckVault Inc.	T-FDFSES2-12L-P5-PF	Ford F-Series Pickup Std 2 Dwr, dimensions: 93L x 48W	\$3,745.00	\$3,207.30
336320	TruckVault Inc.	T-FDFSES2-12L-P5-PF-PT	Ford F-Series Pickup Std 2 Dwr, dimensions: 93L x 48W	\$4,440.00	\$3,802.52
336320	TruckVault Inc.	T-FDFSES2-12L-P5-PF-PW	Ford F-Series Pickup Std 2 Dwr, dimensions: 93L x 48W	\$4,745.00	\$4,063.73
336320	TruckVault Inc.	T-FDFSES2-12L-P5-PT	Ford F-Series Pickup Std 2 Dwr, dimensions: 93L x 48W	\$4,440.00	\$3,802.52
336320	TruckVault Inc.	T-FDFSES2-12L-P5-PW	Ford F-Series Pickup Std 2 Dwr, dimensions: 96L x 48W	\$4,745.00	\$4,063.73
336320	TruckVault Inc.	T-FDFSES2-12S-P5	Ford F-Series Pickup Std 2 Dwr, dimensions: 79L x 48W	\$3,545.00	\$3,036.02
336320	TruckVault Inc.	T-FDFSES2-12S-P5-HT	F-Series Pickup Std 2 Dwr	\$4,240.00	\$3,631.23
336320	TruckVault Inc.	T-FDFSES2-12S-P5-PF	Ford F-Series Pickup Std 2 Dwr, dimensions: 76.5L x 48W	\$3,545.00	\$3,036.02
336320	TruckVault Inc.	T-FDFSES2-12S-P5-PF-PW	Ford F-Series Pickup Std 2 Dwr, dimensions: 78L x 48W	\$4,445.00	\$3,806.80
336320	TruckVault Inc.	T-FDFSES2-12S-P5-PF-ZC8113	F-Series Pickup Std 2 Dwr	\$2,815.00	\$2,410.83
336320	TruckVault Inc.	T-FDFSES2-12S-P5-PT	Ford F-Series Pickup Std 2 Dwr, dimensions: 78L x 48W	\$4,240.00	\$3,631.23

336320	TruckVault Inc.	T-DFSES2-12S-P5-PW	Ford F-Series Pickup Std 2 Dwr, dimensions: 80L x 48W	\$4,445.00	\$3,806.80
336320	TruckVault Inc.	T-DFSES2-15L	Ford F-Series Pickup Std 2 Dwr, dimensions: 94L x 48W	\$3,745.00	\$3,207.30
336320	TruckVault Inc.	T-DFSES2-15L-PW	F-Series Pickup Std 2 Dwr	\$4,745.00	\$4,063.73
336320	TruckVault Inc.	T-DFSES2-15S	F-Series Pickup Std 2 Dwr	\$3,545.00	\$3,036.02
336320	TruckVault Inc.	T-DFSES2-15S-HT	F-Series Pickup Std 2 Dwr	\$4,240.00	\$3,631.23
336320	TruckVault Inc.	T-DFSES2-15S-IW-PW	F-Series Pickup Std 2 Dwr	\$4,045.00	\$3,464.23
336320	TruckVault Inc.	T-DFSES2-15S-ORV	F-Series Pickup Std 2 Dwr	\$3,545.00	\$3,036.02
336320	TruckVault Inc.	T-DFSES2-15S-PC	Ford F-Series Pickup Std 2 Dwr, dimensions: 64L x 48W	\$3,345.00	\$2,864.74
336320	TruckVault Inc.	T-DFSES2-15S-PC-HT	F-Series Pickup Std 2 Dwr	\$4,040.00	\$3,459.95
336320	TruckVault Inc.	T-DFSES2-15S-PC-HT-PW	F-Series Pickup Std 2 Dwr5' 6", S-Crew, All Weather; AW Heavy Duty Table	\$4,840.00	\$4,145.09
336320	TruckVault Inc.	T-DFSES2-15S-PC-IW-PW	F-Series Pickup Std 2 Dwr	\$4,145.00	\$3,549.87
336320	TruckVault Inc.	T-DFSES2-15S-PC-PT	Ford F-Series Pickup Std 2 Dwr, dimensions: 64L x 48W	\$4,040.00	\$3,459.95
336320	TruckVault Inc.	T-DFSES2-15S-PC-PW	Ford F-Series Pickup Std 2 Dwr, dimensions: 65.5L x 48W	\$4,145.00	\$3,549.87
336320	TruckVault Inc.	T-DFSES2-15S-PC-RX	F-Series Pickup Std 2 Dwr5' 6" S-Crew Shortened for Retrax	\$2,765.00	\$2,368.01
336320	TruckVault Inc.	T-DFSES2-15S-PC-RX-PW	F-Series Pickup Std 2 Dwr	\$3,845.00	\$3,292.95
336320	TruckVault Inc.	T-DFSES2-15S-PC-ZC9776	F-Series Pickup Std 2 Dwr	\$3,275.00	\$2,804.79
336320	TruckVault Inc.	T-DFSES2-15S-PW	Ford F-Series Pickup Std 2 Dwr, dimensions: 77.5L x 48W	\$4,045.00	\$3,464.23
336320	TruckVault Inc.	T-DFSES2-15S-RX-PW	F-Series Pickup Std 2 Dwr5' 6", S-Crew, All Weather Retrax	\$4,145.00	\$3,549.87
336320	TruckVault Inc.	T-DFSES2-17L-P5	F-Series Pickup Std 2 Dwr	\$3,745.00	\$3,207.30
336320	TruckVault Inc.	T-DFSES2-17L-P5-C2-PW-ZC11658	F250/350 HD PU CUST 2 Dwr	\$4,845.00	\$4,149.37
336320	TruckVault Inc.	T-DFSES2-17L-P5-PW	F-Series Pickup Std 2 Dwr	\$4,745.00	\$4,063.73
336320	TruckVault Inc.	T-DFSES2-17S-P5	F-Series Pickup Std 2 Dwr	\$3,545.00	\$3,036.02
336320	TruckVault Inc.	T-DFSES2-17S-P5-C2-PW-ZC11636	F250/350 HD PU CUST 2 Dwr	\$4,545.00	\$3,892.44
336320	TruckVault Inc.	T-DFSES2-17S-P5-HT-PW	F-Series Pickup Std 2 Dwr	\$5,140.00	\$4,402.02
336320	TruckVault Inc.	T-DFSES2-17S-P5-L1-ZC10341	F-Series Pickup Std 2 Dwr6' 9" Bed F250/350; C10341	\$4,845.00	\$4,149.37
336320	TruckVault Inc.	T-DFSES2-17S-P5-PW	F-Series Pickup Std 2 Dwr	\$4,445.00	\$3,806.80
336320	TruckVault Inc.	T-DFSES2-17S-P5-PW-ZC8889	F-Series Pickup Std 2 Dwr	\$4,285.00	\$3,669.77
336320	TruckVault Inc.	T-DFSES2-17S-P5-ZC10707A	F-Series Pickup Std 2 DwrC10707A	\$3,275.00	\$2,804.79
336320	TruckVault Inc.	T-DFSES2-84L-P5	Ford F-Series Pickup Std 2 Dwr, dimensions: 95L x 48W	\$3,745.00	\$3,207.30
336320	TruckVault Inc.	T-DFSES2-87L	Ford F-Series Pickup Std 2 Dwr, dimensions: 93.25L x 48W	\$3,745.00	\$3,207.30
336320	TruckVault Inc.	T-DFSES2-87L-PW	Ford F-Series Pickup Std 2 Dwr, dimensions: 96L x 49.25W	\$4,745.00	\$4,063.73
336320	TruckVault Inc.	T-DFSES2-87S	F-Series Pickup Std 2 Dwr	\$3,545.00	\$3,036.02
336320	TruckVault Inc.	T-DFSES2-88L-P5-PW	Ford F-Series Pickup Std 2 Dwr, dimensions: 93.25L x 48W	\$4,745.00	\$4,063.73
336320	TruckVault Inc.	T-DFSES2-92L-P5	F-Series Pickup Std 2 Dwr	\$3,745.00	\$3,207.30
336320	TruckVault Inc.	T-DFSES2-92L-P5-PW	F-Series Pickup Std 2 Dwr	\$4,745.00	\$4,063.73
336320	TruckVault Inc.	T-DFSES2-97L	Ford F-Series Pickup Std 2 Dwr, dimensions: 94.5L x 48W	\$3,745.00	\$3,207.30
336320	TruckVault Inc.	T-DFSES2-97L-P5	Ford F-Series Pickup Std 2 Dwr, dimensions: 95.5L x 48W	\$3,745.00	\$3,207.30
336320	TruckVault Inc.	T-DFSES2-97L-P5-BS	Ford F-Series Pickup Std 2 Dwr, dimensions: 0L x 0W	\$3,445.00	\$2,950.38
336320	TruckVault Inc.	T-DFSES2-97L-P5-PF	Ford F-Series Pickup Std 2 Dwr, dimensions: 93.75L x 48W	\$3,745.00	\$3,207.30
336320	TruckVault Inc.	T-DFSES2-97L-P5-PF-PW	Ford F-Series Pickup Std 2 Dwr, dimensions: 94L x 48W	\$4,745.00	\$4,063.73
336320	TruckVault Inc.	T-DFSES2-97L-P5-PT	Ford F-Series Pickup Std 2 Dwr, dimensions: 95.25L x 48W	\$4,440.00	\$3,802.52
336320	TruckVault Inc.	T-DFSES2-97L-P5-PW	Ford F-Series Pickup Std 2 Dwr, dimensions: 96L x 48W	\$4,745.00	\$4,063.73
336320	TruckVault Inc.	T-DFSES2-97L-PW	Ford F-Series Pickup Std 2 Dwr, dimensions: 96L x 48W	\$4,745.00	\$4,063.73
336320	TruckVault Inc.	T-DFSES2-97S	Ford F-Series Pickup Std 2 Dwr, dimensions: 76.5L x 48W	\$3,545.00	\$3,036.02
336320	TruckVault Inc.	T-DFSES2-97S-P5	Ford F-Series Pickup Std 2 Dwr, dimensions: 80L x 48W	\$3,545.00	\$3,036.02
336320	TruckVault Inc.	T-DFSES2-97S-P5-PF	Ford F-Series Pickup Std 2 Dwr, dimensions: 77.5L x 48W	\$3,545.00	\$3,036.02
336320	TruckVault Inc.	T-DFSES2-97S-P5-PF-PT	Ford F-Series Pickup Std 2 Dwr, dimensions: 77.5L x 48W	\$4,240.00	\$3,631.23
336320	TruckVault Inc.	T-DFSES2-97S-P5-PF-PW	Ford F-Series Pickup Std 2 Dwr, dimensions: 79L x 48W	\$4,445.00	\$3,806.80
336320	TruckVault Inc.	T-DFSES2-97S-P5-PT	Ford F-Series Pickup Std 2 Dwr, dimensions: 80L x 48W	\$4,240.00	\$3,631.23
336320	TruckVault Inc.	T-DFSES2-97S-P5-PW	Ford F-Series Pickup Std 2 Dwr, dimensions: 81L x 48W	\$4,445.00	\$3,806.80
336320	TruckVault Inc.	T-DFSES2-97S-PW	Ford F-Series Pickup Std 2 Dwr, dimensions: 76.5L x 48W	\$4,445.00	\$3,806.80
336320	TruckVault Inc.	T-DFSES3-07S-PC-C2-PW-ZC10649	F-Series PU CUST Std 3 DwrF-150, SB, A-Wthr, Gooseneck;	\$4,645.00	\$3,978.09
336320	TruckVault Inc.	T-DFSES3-12L-P5-C2-PW-ZC9705	F-Series PU CUST Std 3 Dwr	\$5,245.00	\$4,491.94
336320	TruckVault Inc.	T-DFSES3-12S-P5-C2-PW-ZC11625	F-Series PU CUST Std 3 Dwr ReTrax	\$4,945.00	\$4,235.01
336320	TruckVault Inc.	T-DFSES3-12S-P5-C2-PW-ZC8790	F-Series PU CUST Std 3 Dwr	\$4,945.00	\$4,235.01
336320	TruckVault Inc.	T-DFSES3-15S-PC-C2-PW-ZC9704	F-Series PU CUST Std 3 DwrF-150, SB, A-Wthr, Gooseneck;	\$4,645.00	\$3,978.09
336320	TruckVault Inc.	T-DFSES3-17L-P5-C2-PW-ZC8123	F-Series PU CUST Std 3 Dwr	\$5,245.00	\$4,491.94
336320	TruckVault Inc.	T-DFSES3-17S-PC-C2-PW-ZC9704	F-Series PU CUST Std 3 Dwr	\$4,645.00	\$3,978.09
336320	TruckVault Inc.	T-DFSES0-01S-PC	Ford F-Series Pickup Std Offset Dwr, dimensions: 63L x 48W	\$3,345.00	\$2,864.74
336320	TruckVault Inc.	T-DFSES0-01S-PC-PT	Ford F-Series Pickup Std Offset Dwr, dimensions: 63L x 48W	\$4,040.00	\$3,459.95
336320	TruckVault Inc.	T-DFSES0-01S-PC-PW	Ford F-Series Pickup Std Offset Dwr, dimensions: 64L x 48W	\$4,145.00	\$3,549.87
336320	TruckVault Inc.	T-DFSES0-04L	Ford F-Series Pickup Std Offset Dwr, dimensions: 93.75L x 48W	\$3,745.00	\$3,207.30
336320	TruckVault Inc.	T-DFSES0-04S	Ford F-Series Pickup Std OS Dwr, dimensions: 75.625L x 48W	\$3,545.00	\$3,036.02
336320	TruckVault Inc.	T-DFSES0-04S-PC	Ford F-Series Pickup Std OS Dwr, dimensions: 64L x 48W	\$3,345.00	\$2,864.74
336320	TruckVault Inc.	T-DFSES0-04S-PC-PT	Ford F-Series Pickup Std Offset Dwr, dimensions: 63L x 48W	\$4,040.00	\$3,459.95
336320	TruckVault Inc.	T-DFSES0-04S-PC-PW	Ford F-Series Pickup Std OS Dwr, dimensions: 65L x 48W	\$4,145.00	\$3,549.87
336320	TruckVault Inc.	T-DFSES0-04S-PT	Ford F-Series Pickup Std OS Dwr, dimensions: 75.625L x 48W	\$4,240.00	\$3,631.23
336320	TruckVault Inc.	T-DFSES0-04S-PW	Ford F-Series Pickup Std Offset Dwr, dimensions: 76.5L x 48W	\$4,445.00	\$3,806.80



336320	TruckVault Inc.	T-DFSESO-09L-PF	Ford F-Series Pickup Std Offset Dwr, dimensions: 90.75L x 48W	\$3,745.00	\$3,207.30
336320	TruckVault Inc.	T-DFSESO-09L-PF-PW	Ford F-Series Pickup Std OS Dwr, dimensions: 0L x 0W	\$4,745.00	\$4,063.73
336320	TruckVault Inc.	T-DFSESO-09S-PC-PF	Ford F-Series Pickup Std Offset Dwr, dimensions: 63L x 48W	\$3,345.00	\$2,864.74
336320	TruckVault Inc.	T-DFSESO-09S-PC-PF-PT	Ford F-Series Std Offset Table Ext, dimensions: 64L x 48W	\$4,040.00	\$3,459.95
336320	TruckVault Inc.	T-DFSESO-09S-PC-PF-PW	Ford F-Series Pickup Std OS Dwr, dimensions: 64L x 48W	\$4,145.00	\$3,549.87
336320	TruckVault Inc.	T-DFSESO-09S-PF	Ford F-Series Pickup Std Offset Dwr, dimensions: 74L x 48W	\$3,545.00	\$3,036.02
336320	TruckVault Inc.	T-DFSESO-09S-PF-PW	Ford F-Series Pickup Std OS Dwr, dimensions: 73.5L x 48W	\$4,445.00	\$3,806.80
336320	TruckVault Inc.	T-DFSESO-12L-P5	Ford F-Series Pickup Std Offset Dwr, dimensions: 94.5L x 48W	\$3,745.00	\$3,207.30
336320	TruckVault Inc.	T-DFSESO-12L-P5-PF	Ford F-Series Pickup Std Offset Dwr, dimensions: 93.75L x 48W	\$3,745.00	\$3,207.30
336320	TruckVault Inc.	T-DFSESO-12L-P5-PF-PW	Ford F-Series Pickup Std Offset Dwr, dimensions: 94L x 48W	\$4,745.00	\$4,063.73
336320	TruckVault Inc.	T-DFSESO-12L-P5-PW	Ford F-Series Pickup Std Offset Dwr, dimensions: 95L x 48W	\$4,745.00	\$4,063.73
336320	TruckVault Inc.	T-DFSESO-12S-P5	Ford F-Series Pickup Std Offset Dwr, dimensions: 79.25L x 48W	\$3,545.00	\$3,036.02
336320	TruckVault Inc.	T-DFSESO-12S-P5-PF	Ford F-Series Pickup Std Offset Dwr, dimensions: 77.5L x 48W	\$3,545.00	\$3,036.02
336320	TruckVault Inc.	T-DFSESO-12S-P5-PF-PW	Ford F-Series Pickup Std Offset Dwr, dimensions: 78L x 48W	\$4,445.00	\$3,806.80
336320	TruckVault Inc.	T-DFSESO-12S-P5-PW	Ford F-Series Pickup Std Offset Dwr, dimensions: 80L x 48W	\$4,445.00	\$3,806.80
336320	TruckVault Inc.	T-DFSESO-15L	F-Series Pickup Std OS Dwr	\$3,745.00	\$3,207.30
336320	TruckVault Inc.	T-DFSESO-15L-PW	F-Series Pickup Std OS Dwr	\$4,745.00	\$4,063.73
336320	TruckVault Inc.	T-DFSESO-15S	F-Series Pickup Std Offset Dwr	\$3,545.00	\$3,036.02
336320	TruckVault Inc.	T-DFSESO-15S-PC	Ford F-Series Pickup Std Offset Dwr, dimensions: 64L x 48W	\$3,345.00	\$2,864.74
336320	TruckVault Inc.	T-DFSESO-15S-PC-IW-PW	F-Series Pickup Std Offset Dwr	\$4,145.00	\$3,549.87
336320	TruckVault Inc.	T-DFSESO-15S-PC-PW	Ford F-Series Pickup Std Offset Dwr, dimensions: 65.5L x 48W	\$4,145.00	\$3,549.87
336320	TruckVault Inc.	T-DFSESO-15S-PC-PW-ZC10859	F-Series Pickup CustomC10859	\$3,925.00	\$3,361.46
336320	TruckVault Inc.	T-DFSESO-15S-PW	Ford F-Series Pickup Std Offset Dwr, dimensions: 77.5L x 48W	\$4,445.00	\$3,806.80
336320	TruckVault Inc.	T-DFSESO-17L-P5	F-Series Pickup Std Offset Dwr	\$3,745.00	\$3,207.30
336320	TruckVault Inc.	T-DFSESO-17L-P5-PW	F-Series Pickup Std Offset Dwr	\$4,745.00	\$4,063.73
336320	TruckVault Inc.	T-DFSESO-17S-P5	F-Series Pickup Std Offset Dwr	\$3,545.00	\$3,036.02
336320	TruckVault Inc.	T-DFSESO-17S-P5-PW	F-Series Pickup Std Offset Dwr	\$4,445.00	\$3,806.80
336320	TruckVault Inc.	T-DFSESO-17S-P5-PW-ZC10176	F-Series Pickup Custom 2 DwrC10176	\$3,905.00	\$3,344.33
336320	TruckVault Inc.	T-DFSESO-92L-P5-PW	F-Series Pickup Std 2 Dwr Offset	\$4,745.00	\$4,063.73
336320	TruckVault Inc.	T-DFSESO-97L	Ford F-Series Pickup Std Offset Dwr, dimensions: 93.25L x 48W	\$3,745.00	\$3,207.30
336320	TruckVault Inc.	T-DFSESO-97L-P5	Ford F-Series Pickup Std Offset Dwr, dimensions: 95.5L x 48W	\$3,745.00	\$3,207.30
336320	TruckVault Inc.	T-DFSESO-97L-P5-PF	Ford F-Series Pickup Std Offset Dwr, dimensions: 93.75L x 48W	\$3,745.00	\$3,207.30
336320	TruckVault Inc.	T-DFSESO-97L-P5-PF-PW	Ford F-Series Pickup Std Offset Dwr, dimensions: 93L x 48W	\$4,745.00	\$4,063.73
336320	TruckVault Inc.	T-DFSESO-97L-P5-PW	Ford F-Series Pickup Std Offset Dwr, dimensions: 96L x 48W	\$4,745.00	\$4,063.73
336320	TruckVault Inc.	T-DFSESO-97L-PW	Ford F-Series Pickup Std Offset Dwr, dimensions: 96L x 48W	\$4,745.00	\$4,063.73
336320	TruckVault Inc.	T-DFSESO-97S	Ford F-Series Pickup Std Offset Dwr, dimensions: 76.5L x 48W	\$3,545.00	\$3,036.02
336320	TruckVault Inc.	T-DFSESO-97S-P5	Ford F-Series Pickup Std Offset Dwr, dimensions: 80L x 48W	\$3,545.00	\$3,036.02
336320	TruckVault Inc.	T-DFSESO-97S-P5-PF	Ford F-Series Pickup Std Offset Dwr, dimensions: 77.5L x 48W	\$3,545.00	\$3,036.02
336320	TruckVault Inc.	T-DFSESO-97S-P5-PF-PT	Ford F-Series Pickup Std Offset Dwr, dimensions: 77.5L x 48W	\$4,240.00	\$3,631.23
336320	TruckVault Inc.	T-DFSESO-97S-P5-PF-PW	Ford F-Series Pickup Std Offset Dwr, dimensions: 79L x 48W	\$4,445.00	\$3,806.80
336320	TruckVault Inc.	T-DFSESO-97S-P5-PT	Ford F-Series Pickup Std Offset Dwr, dimensions: 80.25L x 48W	\$4,240.00	\$3,631.23
336320	TruckVault Inc.	T-DFSESO-97S-P5-PW	Ford F-Series Pickup Std Offset Dwr, dimensions: 81L x 48W	\$4,445.00	\$3,806.80
336320	TruckVault Inc.	T-DFSESO-97S-PW	Ford F-Series Pickup Std Offset Dwr, dimensions: 76.5L x 48W	\$4,445.00	\$3,806.80
336320	TruckVault Inc.	T-DFSEU1-12S-P5-HP-PW	F-Series Utility 1 Dwr Half Width6' 9", A-Wthr, Passenger Side	\$2,945.00	\$2,522.17
336320	TruckVault Inc.	T-DFSEU1-15L-HP	F-Series Std 1 Dwr Half Width8' Bed, P Side	\$2,545.00	\$2,179.60
336320	TruckVault Inc.	T-DFSEU1-15S-HD	F-Series Utility 1 Dwr Half Width	\$2,435.00	\$2,085.39
336320	TruckVault Inc.	T-DFSEU1-15S-HD-PW	F-Series Utility 1 Dwr Half Width	\$2,845.00	\$2,436.52
336320	TruckVault Inc.	T-DFSEU1-15S-HP	F-Series Utility 1 Dwr Half Width	\$2,435.00	\$2,085.39
336320	TruckVault Inc.	T-DFSEU1-15S-HP-PW	F-Series Utility 1 Dwr Half Width	\$2,845.00	\$2,436.52
336320	TruckVault Inc.	T-DFSEU1-15S-PC-HD	F-Series Utility 1 Dwr Half Width	\$2,325.00	\$1,991.18
336320	TruckVault Inc.	T-DFSEU1-15S-PC-HD-PW	F-Series Utility 1 Dwr Half Width	\$2,645.00	\$2,265.24
336320	TruckVault Inc.	T-DFSEU1-15S-PC-HP	F-Series Utility 1 Dwr Half Width	\$2,325.00	\$1,991.18
336320	TruckVault Inc.	T-DFSEU1-15S-PC-HP-PW	F-Series Utility 1 Dwr Half Width	\$2,645.00	\$2,265.24
336320	TruckVault Inc.	T-DFSEU1-17L-P5-HP	F-Series Utility 1 Dwr Half Width8'; Passenger Side	\$2,545.00	\$2,179.60
336320	TruckVault Inc.	T-DFSEU1-17S-P5-HD-PW	F-Series Utility 1 Dwr Half Width	\$2,435.00	\$2,085.39
336320	TruckVault Inc.	T-DFSEU1-17S-P5-HD-PW-RX	F-Series Utility 1 Dwr Half Width6'9" Bed, AW, Driver Side, ReTrax	\$2,645.00	\$2,265.24
336320	TruckVault Inc.	T-DFSEU1-17S-P5-HP	F-Series Utility1 Dwr Half Width6' Bed, Passenger Side	\$2,435.00	\$2,085.39
336320	TruckVault Inc.	T-DFSEU1-17S-P5-HP-PW	F-Series Utility 1 Dwr Half Width	\$2,435.00	\$2,085.39
336320	TruckVault Inc.	T-DFSEU1-17S-P5-HP-RX	F-Series Utility 1 Dwr Half Width6' Bed, Passenger Side Retrax	\$2,325.00	\$1,991.18
336320	TruckVault Inc.	T-DFSEU1-17S-P5-PW-ZC10354	F-Series Utility 1 Dwr CustomC10354	\$2,225.00	\$1,905.54
336320	TruckVault Inc.	T-DFSEU1-17S-P5-PW-ZC10677	F-Series Custom 1 DwrC10677	\$4,795.00	\$4,106.55
336320	TruckVault Inc.	T-DFSEU1-97S-P5-HP-PW	F-Series Utility 1 Dwr Half Width	\$2,945.00	\$2,522.17

336320	TruckVault Inc.	T-FDFSEU2-04S	F-Series Pickup Utility 2 Dwr	\$3,645.00	\$3,121.66
336320	TruckVault Inc.	T-FDFSEU2-04S-PC	F-Series Pickup Utility 2 Dwr	\$3,445.00	\$2,950.38
336320	TruckVault Inc.	T-FDFSEU2-04S-PC-PW	F-Series Pickup Utility 2 Dwr5' 6" S-Crew, A-Wthr	\$4,245.00	\$3,635.52
336320	TruckVault Inc.	T-FDFSEU2-04S-PW	F-Series Pickup Utility 2 Dwr6' 6" Short Bed, All Weather	\$4,545.00	\$3,892.44
336320	TruckVault Inc.	T-FDFSEU2-09S-PC-PF	F-Series Pickup Utility 2 Dwr	\$3,445.00	\$2,950.38
336320	TruckVault Inc.	T-FDFSEU2-09S-PC-PF-PW	F-Series Pickup Utility 2 Dwr5' 6", S-Crew, All Weather TG Step	\$4,245.00	\$3,635.52
336320	TruckVault Inc.	T-FDFSEU2-09S-PF	F-Series Pickup Utility 2 Dwr6' 6", Folding Step	\$3,645.00	\$3,121.66
336320	TruckVault Inc.	T-FDFSEU2-12L-P5	F-Series Pickup Utility 2 Dwr	\$3,845.00	\$3,292.95
336320	TruckVault Inc.	T-FDFSEU2-12L-P5-PF-PW	F-Series Pickup 2 Dwr8' Long Bed F-250/350, A-Wthr	\$4,845.00	\$4,149.37
336320	TruckVault Inc.	T-FDFSEU2-12L-P5-PW	F-Series Pickup 2 Dwr8' Long Bed F-250/350, A-Wthr	\$4,845.00	\$4,149.37
336320	TruckVault Inc.	T-FDFSEU2-12L-P5-PW-ZC8572	F-Series Pickup Utility 2 Dwr	\$4,405.00	\$3,772.54
336320	TruckVault Inc.	T-FDFSEU2-12S-P5	F-Series Pickup Utility 2 Dwr	\$3,645.00	\$3,121.66
336320	TruckVault Inc.	T-FDFSEU2-12S-P5-PF	F-Series Pickup Utility 2 Dwr	\$3,645.00	\$3,121.66
336320	TruckVault Inc.	T-FDFSEU2-12S-P5-PF-PW	F-Series Pickup Utility 2 Dwr	\$4,545.00	\$3,892.44
336320	TruckVault Inc.	T-FDFSEU2-12S-P5-PW	F-Series Pickup Utility 2 Dwr	\$4,545.00	\$3,892.44
336320	TruckVault Inc.	T-FDFSEU2-15L	F-Series Pickup Utility 2 Dwr	\$3,845.00	\$3,292.95
336320	TruckVault Inc.	T-FDFSEU2-15L-PW	F-Series Pickup Utility 2 Dwr	\$4,845.00	\$4,149.37
336320	TruckVault Inc.	T-FDFSEU2-15S	F-Series Pickup Utility 2 Dwr	\$3,645.00	\$3,121.66
336320	TruckVault Inc.	T-FDFSEU2-15S-PC	F-Series Pickup Utility 2 Dwr	\$3,445.00	\$2,950.38
336320	TruckVault Inc.	T-FDFSEU2-15S-PC-PW	F-Series Pickup Utility 2 Dwr	\$4,245.00	\$3,635.52
336320	TruckVault Inc.	T-FDFSEU2-15S-PC-PW-ZC10155	F-Series Pickup Utility 2 DwrC10155	\$3,115.00	\$2,667.76
336320	TruckVault Inc.	T-FDFSEU2-15S-PC-RX-PW	F-Series Pickup Utility 2 Dwr5' 6", S-Crew, All Weather ReTrax	\$3,945.00	\$3,378.59
336320	TruckVault Inc.	T-FDFSEU2-15S-PW	F-Series Pickup Utility 2 Dwr	\$4,545.00	\$3,892.44
336320	TruckVault Inc.	T-FDFSEU2-15S-RX	F-Series Pickup Utility 2 Dwr	\$3,445.00	\$2,950.38
336320	TruckVault Inc.	T-FDFSEU2-15S-RX-PW	F-Series Pickup Utility 2 Dwr6' 6" SB, All Weather, ReTrax	\$4,245.00	\$3,635.52
336320	TruckVault Inc.	T-FDFSEU2-17L-P5	F-Series Pickup Utility 2 Dwr	\$3,845.00	\$3,292.95
336320	TruckVault Inc.	T-FDFSEU2-17L-P5-C2-PW-ZC11664	F250/350 HD PU CUST 2 Dwr	\$4,945.00	\$4,235.01
336320	TruckVault Inc.	T-FDFSEU2-17L-P5-PW	F-Series Pickup Utility 2 Dwr	\$4,845.00	\$4,149.37
336320	TruckVault Inc.	T-FDFSEU2-17L-P5-PW-ZC10227	F-Series Pickup Utility 2 Dwr8' Long Bed F-250/350, A-Wthr	\$4,325.00	\$3,704.03
336320	TruckVault Inc.	T-FDFSEU2-17L-P5-PW-ZC11285	F-Series Pickup Utility 2 DwrC11285	\$4,325.00	\$3,704.03
336320	TruckVault Inc.	T-FDFSEU2-17L-P5-RX	F-Series Pickup Utility 2 Dwr8' Long Bed F-250/350 Retrax	\$3,645.00	\$3,121.66
336320	TruckVault Inc.	T-FDFSEU2-17S-P5	F-Series Pickup Utility 2 Dwr	\$3,645.00	\$3,121.66
336320	TruckVault Inc.	T-FDFSEU2-17S-P5-C4-PW-ZC11789	F-Series PU CUST Utility 2 Dwr	\$4,825.00	\$4,132.24
336320	TruckVault Inc.	T-FDFSEU2-17S-P5-PW	F-Series Pickup Utility 2 Dwr	\$4,545.00	\$3,892.44
336320	TruckVault Inc.	T-FDFSEU2-17S-P5-PW-ZC9646	F-Series Pickup Utility 2 Dwr to 60"	\$4,405.00	\$3,772.54
336320	TruckVault Inc.	T-FDFSEU2-17S-P5-RX-PW	F-Series Pickup Utility 2 Dwr6' 9" Bed F250/350, ReTrtax A-Wthr	\$4,245.00	\$3,635.52
336320	TruckVault Inc.	T-FDFSEU2-17S-P5-ZC11136B	F-Series Pickup Utility 2 DwrC11136B	\$3,375.00	\$2,890.43
336320	TruckVault Inc.	T-FDFSEU2-87S	F-Series Pickup Utility 2 Dwr	\$3,645.00	\$3,121.66
336320	TruckVault Inc.	T-FDFSEU2-92L-P5	F-Series Pickup Utility 2 Dwr	\$3,845.00	\$3,292.95
336320	TruckVault Inc.	T-FDFSEU2-97L-P5-PW	F-Series Pickup Utility 2 Dwr	\$4,845.00	\$4,149.37
336320	TruckVault Inc.	T-FDFSEU2-97L-PW	F-Series Pickup Utility 2 Dwr8' Long Bed, A-Wthr	\$4,845.00	\$4,149.37
336320	TruckVault Inc.	T-FDFSEU2-97L-PW-ZC10562	F-Series Pickup Utility 2 Dwr8' Long Bed/All Wea; C10562	\$5,375.00	\$4,603.27
336320	TruckVault Inc.	T-FDFSEU2-97S-P5	F-Series Pickup Utility 2 Dwr	\$3,645.00	\$3,121.66
336320	TruckVault Inc.	T-FDFSEU2-97S-P5-PW	F-Series Pickup Utility 2 Dwr	\$4,545.00	\$3,892.44
336320	TruckVault Inc.	T-FDFSEU3-12L-P5-C2-PW-ZC11067	F-Series PU CUST Utility 3 DwrF-250/350, LB, A-Wthr, Gooseneck; C11067	\$5,345.00	\$4,577.58
336320	TruckVault Inc.	T-FDFSEU3-12S-P5-C2-PW-ZC11638	F-Series PU CUST Utility 3 Dwr	\$5,045.00	\$4,320.65
336320	TruckVault Inc.	T-FDFSEU3-15S-PC-C2-PW-ZC10662	F-Series PU CUST Utility 3 DwrF-150, SB, A-Wthr, Gooseneck;	\$4,745.00	\$4,063.73
336320	TruckVault Inc.	T-FDFSEU3-17L-P5-C2-PW-ZC9707	F-Series PU CUST Utility 3 Dwr	\$5,345.00	\$4,577.58
336320	TruckVault Inc.	T-FDFSEU3-17L-P5-RX-PW-ZC11672	F-Series PU CUST Utility 3 Dwr ReTrax	\$5,045.00	\$4,320.65
336320	TruckVault Inc.	T-FDFSEU3-17S-P5-C2-PW-ZC10037	F-Series PU CUST Utility 3 Dwr	\$4,945.00	\$4,235.01
336320	TruckVault Inc.	T-FDFSEU3-17S-P5-C2-PW-ZC11289	F-Series PU CUST Utility 3 Dwr ReTraxF-250/350, SB, A-Wthr, Gooseneck;	\$4,745.00	\$4,063.73
336320	TruckVault Inc.	T-FDFSEU3-97L-P5-C2-PW-ZC10168	F-Series PU CUST Utility 3 DwrF-250/350, LB, A-Wthr, Gooseneck; C10168	\$5,345.00	\$4,577.58
336320	TruckVault Inc.	T-FDFSEUO-04S-PC	F-Series Pickup Utility OS Dwr	\$3,445.00	\$2,950.38
336320	TruckVault Inc.	T-FDFSEUO-04S-PC-L1-PW-ZC9794	F-Series Pickup Utility OS Dwr	\$6,355.00	\$5,442.57
336320	TruckVault Inc.	T-FDFSEUO-04S-PC-PW	F-Series Pickup Utility OS Dwr	\$4,245.00	\$3,635.52
336320	TruckVault Inc.	T-FDFSEUO-09S-PC-PF	F-Series Pickup Utility Offset Dwr	\$3,445.00	\$2,950.38
336320	TruckVault Inc.	T-FDFSEUO-12L-P5	F-Series Pickup Utility Offset Dwr8' Long Bed F-250/350	\$3,845.00	\$3,292.95
336320	TruckVault Inc.	T-FDFSEUO-12L-P5-PW	F-Series Pickup Offset Dwr	\$4,845.00	\$4,149.37
336320	TruckVault Inc.	T-FDFSEUO-12S-P5-PW	F-Series Pickup Utility Offset Dwr	\$4,545.00	\$3,892.44
336320	TruckVault Inc.	T-FDFSEUO-15L	F-Series Pickup Utility 2 Dwr Offset	\$3,725.00	\$3,190.18
336320	TruckVault Inc.	T-FDFSEUO-15S	F-Series Pickup Utility 2 Dwr Offset6' 6" Short Bed	\$3,645.00	\$3,121.66
336320	TruckVault Inc.	T-FDFSEUO-15S-PC	F-Series Pickup Utility OS Dwr	\$3,445.00	\$2,950.38
336320	TruckVault Inc.	T-FDFSEUO-15S-PC-PW	F-Series Pickup Utility OS Dwr	\$4,245.00	\$3,635.52
336320	TruckVault Inc.	T-FDFSEUO-15S-PC-RX-PW	F-Series Pickup Utility OS Dwr5' 6", S-Crew, All Weather ReTrax	\$3,945.00	\$3,378.59
336320	TruckVault Inc.	T-FDFSEUO-15S-PW	F-Series Pickup Utility OS Dwr	\$4,545.00	\$3,892.44

336320	TruckVault Inc.	T-FDFSEUO-15S-PW-ZC11801B	F-Series Pickup Utility custom Offset Dwr	\$4,445.00	\$3,806.80
336320	TruckVault Inc.	T-FDFSEUO-15S-RX	F-Series Pickup Utility 2 Dwr Offset	\$3,445.00	\$2,950.38
336320	TruckVault Inc.	T-FDFSEUO-15S-RX-PW	F-Series Pickup Utility 2 Dwr Offset	\$4,245.00	\$3,635.52
336320	TruckVault Inc.	T-FDFSEUO-17L-P5	F-Series Pickup Utility OS Dwr	\$3,845.00	\$3,292.95
336320	TruckVault Inc.	T-FDFSEUO-17L-P5-PW	F-Series Pickup Utility Offset Dwr	\$4,845.00	\$4,149.37
336320	TruckVault Inc.	T-FDFSEUO-17S-P5	F-Series Pickup Utility Offset Dwr	\$3,645.00	\$3,121.66
336320	TruckVault Inc.	T-FDFSEUO-17S-P5-HM	F-Series Pickup Utility Offset Dwr	\$3,645.00	\$3,121.66
336320	TruckVault Inc.	T-FDFSEUO-17S-P5-PW	F-Series Pickup Utility OS Dwr	\$4,545.00	\$3,892.44
336320	TruckVault Inc.	T-FDFSEUO-17S-P5-PW-ZC11335	F-Series Custom	\$4,955.00	\$4,243.58
336320	TruckVault Inc.	T-FDFSEUO-87L	F-Series Pickup Utility 2 Dwr Offset8' Bed	\$3,845.00	\$3,292.95
336320	TruckVault Inc.	T-FDFSEUO-92L-P5-PW	F-Series Pickup Utility OS Dwr8' Bed F-250/350, All-Wthr	\$4,845.00	\$4,149.37
336320	TruckVault Inc.	T-FDFSEUO-97L-P5	F-Series Pickup Utility Offset Dwr	\$3,845.00	\$3,292.95
336320	TruckVault Inc.	T-FDFSEUO-97L-PW	F-Series Pickup Utility Offset Dwr8' Long Bed, A-Wthr	\$4,845.00	\$4,149.37
336320	TruckVault Inc.	T-FDFSEUO-97S-P5	F-Series Pickup Utility OS Dwr	\$3,645.00	\$3,121.66
336320	TruckVault Inc.	T-FDFFSM2-04S	Ford F-Series, Flare Mag 2 Dwr, dimensions: 76L x 48W	\$3,745.00	\$3,207.30
336320	TruckVault Inc.	T-FDFFSM2-04S-PW	Ford F-Series Flare Mag 2 Dwr, dimensions: 76L x 48W	\$4,645.00	\$3,978.09
336320	TruckVault Inc.	T-FDFFSM2-99S	Ford F-Series, Flare Mag 2 Dwr, dimensions: 62.5L x 47W	\$3,545.00	\$3,036.02
336320	TruckVault Inc.	T-FDFFSM2-99S-PW	Ford F-Series Flare Mag 2 Dwr, dimensions: 76L x 48W	\$4,645.00	\$3,978.09
336320	TruckVault Inc.	T-FDFFSMO-04S	Ford F-Series, Flare Mag 2 Dwr OS, dimensions: 76L x 48W	\$3,745.00	\$3,207.30
336320	TruckVault Inc.	T-FDFFSMO-99S-PW	Ford F-Series Flare Mag OS Dwr, dimensions: 76L x 48W	\$4,645.00	\$3,978.09
336320	TruckVault Inc.	T-FDFFS2-04S	Ford F-Series, Flare Std 2 Dwr, dimensions: 76L x 48W	\$3,545.00	\$3,036.02
336320	TruckVault Inc.	T-FDFFS2-04S-PW	Ford F-Series, Flare Std 2 Dwr, dimensions: 0L x 0W	\$4,445.00	\$3,806.80
336320	TruckVault Inc.	T-FDFFS2-99S	Ford F-Series, Flare Std 2 Dwr, dimensions: 77L x 48W	\$3,545.00	\$3,036.02
336320	TruckVault Inc.	T-FDFFS2-99S-PW	Ford F-Series, Flare Std 2 Dwr, dimensions: 76L x 48W	\$4,445.00	\$3,806.80
336320	TruckVault Inc.	T-FDFFSO-04S	Ford F-Series, Flare Std Offset Dwr, dimensions: 76L x 48W	\$3,545.00	\$3,036.02
336320	TruckVault Inc.	T-FDFFSO-99S	Ford F-Series, Flare Std Offset Dwr, dimensions: 77L x 48W	\$3,545.00	\$3,036.02
336320	TruckVault Inc.	T-FDMAXM1-18F-HD	Expedition Max Mag 1 Dwr	\$2,095.00	\$1,794.21
336320	TruckVault Inc.	T-FDMAXM1-18F-HP	Expedition Max Mag 1 Dwr3rd Row Folded / 1/2 Width Passenger Side	\$2,095.00	\$1,794.21
336320	TruckVault Inc.	T-FDMAXM1-18F-TR-HD	Expedition Max Mag 1 Dwr	\$2,095.00	\$1,794.21
336320	TruckVault Inc.	T-FDMAXM1-18F-TR-HT	Expedition Max Mag 1 DwrFull-Length; Seat Removed	\$3,190.00	\$2,731.99
336320	TruckVault Inc.	T-FDMAXM1-18M	Expedition Max Mag 1 DwrMid-Length; Seat Folded	\$2,435.00	\$2,085.39
336320	TruckVault Inc.	T-FDMAXM1-18M-TR	Expedition Max Mag 1 Dwr	\$2,435.00	\$2,085.39
336320	TruckVault Inc.	T-FDMAXM1-18N-C1-ZC11070	Expedition Max Mag 1 Dwr CustomC11070; 3rd Row Folded	\$2,515.00	\$2,153.90
336320	TruckVault Inc.	T-FDMAXM1-18N-C1-ZC7810	Expedition MAX Mag 1 Dwr Custom	\$1,575.00	\$1,348.87
336320	TruckVault Inc.	T-FDMAXM1-18N-ZC11040	Expedition Max Mag 1 Dwr CustomC11040	\$2,195.00	\$1,879.85
336320	TruckVault Inc.	T-FDMAXM1-18S	Expedition Max Mag 1 Dwr	\$2,095.00	\$1,794.21
336320	TruckVault Inc.	T-FDMAXM1-18S-HT	Expedition Max Mag 1 DwrShort Size HD Table	\$2,790.00	\$2,389.42
336320	TruckVault Inc.	T-FDMAXM2-18F	Expedition Max Mag 2 Dwr	\$3,045.00	\$2,607.81
336320	TruckVault Inc.	T-FDMAXM2-18F-PP	Expedition Max Mag 2 DwrMust Fold 3rd Seat; P-Cage	\$2,985.00	\$2,556.42
336320	TruckVault Inc.	T-FDMAXM2-18F-PP-TR	Expedition Max Mag 2 Dwr	\$2,985.00	\$2,556.42
336320	TruckVault Inc.	T-FDMAXM2-18F-TR	Expedition Max Mag 2 Dwr	\$3,045.00	\$2,607.81
336320	TruckVault Inc.	T-FDMAXM2-18F-TR-HT	Expedition Max Mag 2 Dwr	\$3,740.00	\$3,203.02
336320	TruckVault Inc.	T-FDMAXM2-18N-TT-ZC10683	Expedition Max Mag 2 DwrC10683	\$4,735.00	\$4,055.16
336320	TruckVault Inc.	T-FDMAXM2-18S	Expedition Max Mag 2 Dwr	\$2,645.00	\$2,265.24
336320	TruckVault Inc.	T-FDMAXMO-18F	Expedition Max Mag OS Dwr	\$3,045.00	\$2,607.81
336320	TruckVault Inc.	T-FDMAXMO-18F-PP-TR	Expedition Max Mag OS Dwr	\$2,985.00	\$2,556.42
336320	TruckVault Inc.	T-FDMAXMO-18F-TR	Expedition Max Mag OS Dwr	\$3,045.00	\$2,607.81
336320	TruckVault Inc.	T-FDMAXMO-18M	Expedition Max Mag 2 Dwr OffsetFolded 3rd Seat	\$2,985.00	\$2,556.42
336320	TruckVault Inc.	T-FDMAXMO-18M-TR-HT	Expedition Max Mag 2 Dwr Offset 3rd Seat Removed	\$3,740.00	\$3,203.02
336320	TruckVault Inc.	T-FDMAXMO-18N-HT-ZC10287	Expedition Max Mag OS DwrC10287; Heavy Duty Table	\$3,395.00	\$2,907.56
336320	TruckVault Inc.	T-FDMAXN1-18N-TR-ZC10062	Expedition Max Custom 1 DwrC10062; Removed 3rd Row	\$1,875.00	\$1,605.79
336320	TruckVault Inc.	T-FDMAXN1-18N-ZC10061	Expedition Max Custom 1 DwrC10061; Folded 3rd Row	\$1,875.00	\$1,605.79
336320	TruckVault Inc.	T-FDMAXN2-18N-TR-ZC11742	Expedition Max Custom 2 Dwr	\$3,100.00	\$2,654.91
336320	TruckVault Inc.	T-FDMAXS1-18S	Expedition Max Std 1 Dwr	\$1,895.00	\$1,622.92
336320	TruckVault Inc.	T-FDMAXS2-18F	Expedition Max Std 2 Dwr	\$2,845.00	\$2,436.52
336320	TruckVault Inc.	T-FDMAXS2-18F-PP-TR	Expedition Max Std 2 Dwr	\$2,765.00	\$2,368.01
336320	TruckVault Inc.	T-FDMAXS2-18F-TR	Expedition Max Std 2 Dwr	\$2,845.00	\$2,436.52
336320	TruckVault Inc.	T-FDMAXS2-18M	Expedition Max Std 2 DwrFolded 3rd Seat	\$2,765.00	\$2,368.01
336320	TruckVault Inc.	T-FDMAXS2-18S	Expedition Max Std 2 DwrShort Size	\$2,245.00	\$1,922.67
336320	TruckVault Inc.	T-FDMAXS2-18S-HT	Expedition Max Std 2 Dwr	\$3,140.00	\$2,689.17
336320	TruckVault Inc.	T-FDMAXSO-18F	Expedition Max Std OS Dwr	\$2,845.00	\$2,436.52
336320	TruckVault Inc.	T-FDMAXSO-18F-TR-HT	Expedition Max Std 2 Dwr Offset3rd Row Seat Removed or SSV, HD Table	\$3,540.00	\$3,031.74
336320	TruckVault Inc.	T-FDMAXSO-18S-PT	Expedition Max Std Offset Dwr	\$2,940.00	\$2,517.88
336320	TruckVault Inc.	T-FDMAXU1-18M	Expedition Max Utility 1 Dwr	\$2,325.00	\$1,991.18
336320	TruckVault Inc.	T-FDMAXU1-18M-TR	Expedition Max Utility 1 Dwr	\$2,325.00	\$1,991.18
336320	TruckVault Inc.	T-FDMAXU1-18S	Expedition Max Utility1 Dwr	\$1,725.00	\$1,477.33
336320	TruckVault Inc.	T-FDMAXU1-18S-HT	Expedition Max Utility 1 Dwr	\$2,690.00	\$2,303.78

336320	TruckVault Inc.	T-FDMAXU2-18F	Expedition Max Utility 2 Dwr	\$2,945.00	\$2,522.17
336320	TruckVault Inc.	T-FDMAXU2-18F-TR	Expedition Max Utility 2 Dwr	\$2,945.00	\$2,522.17
336320	TruckVault Inc.	T-FDMAXU2-18F-TR-HT	Expedition Max Utility 2 Dwr	\$3,640.00	\$3,117.38
336320	TruckVault Inc.	T-FDMAXUO-18F-PT	Expedition Max Utility OS Dwr	\$3,640.00	\$3,117.38
336320	TruckVault Inc.	T-FDMAXUO-18F-TR-HT	Expedition Max Utility 2 Dwr Offset	\$3,640.00	\$3,117.38
336320	TruckVault Inc.	T-FDMAXUO-18N-TR-C1-HT-ZC10044	Expedition Max Utility 1 Dwr	\$3,865.00	\$3,310.08
336320	TruckVault Inc.	T-FDMAXUO-18S	Expedition Max Utility Offset Dwr	\$2,345.00	\$2,008.31
336320	TruckVault Inc.	T-FDRAFS2-93S-PW	Ford Ranger Flare Pickup Std 2 Dwr, dimensions: 1L x 1W	\$4,045.00	\$3,464.23
336320	TruckVault Inc.	T-FDRAFS2-99S-PW	Ford Ranger Flare Pickup Std 2 Dwr, dimensions: 1L x 1W	\$4,045.00	\$3,464.23
336320	TruckVault Inc.	T-FDRANM1-19S-HD-PW	Ranger Pickup Mag 1 Dwr	\$2,645.00	\$2,265.24
336320	TruckVault Inc.	T-FDRANM1-19S-HD-RX-PW	Ranger Pickup Mag 1 Dwr	\$2,445.00	\$2,093.95
336320	TruckVault Inc.	T-FDRANM1-19S-HP	Ranger Pickup Mag 1 Dwr6' Short Bed; Passenger Side	\$2,325.00	\$1,991.18
336320	TruckVault Inc.	T-FDRANM1-19S-HP-RX	Ranger Pickup Mag 1 Dwr	\$2,125.00	\$1,819.90
336320	TruckVault Inc.	T-FDRANM1-19S-HP-RX-PW	Ranger Pickup Mag 1 Dwr	\$2,445.00	\$2,093.95
336320	TruckVault Inc.	T-FDRANM1-19S-PC-HD	Ranger Pickup Mag 1 Dwr5' Short Bed; Drivers Side	\$2,195.00	\$1,879.85
336320	TruckVault Inc.	T-FDRANM1-19S-PC-HD-PW	Ranger Pickup Mag 1 Dwr5' SB, A-Wthr, Drivers Side	\$2,445.00	\$2,093.95
336320	TruckVault Inc.	T-FDRANM1-19S-PC-HP	Ranger Pickup Mag 1 Dwr5' Short Bed; Passenger Side	\$2,195.00	\$1,879.85
336320	TruckVault Inc.	T-FDRANM2-19S	Ranger Pickup Mag 2 Dwr	\$3,345.00	\$2,864.74
336320	TruckVault Inc.	T-FDRANM2-19S-PC	Ranger Pickup Mag 2 Dwr5' Short Bed	\$3,145.00	\$2,693.45
336320	TruckVault Inc.	T-FDRANM2-19S-PC-PW	Ranger Pickup Mag 2 Dwr	\$3,945.00	\$3,378.59
336320	TruckVault Inc.	T-FDRANM2-19S-PW	Ranger Pickup Mag 2 Dwr	\$4,245.00	\$3,635.52
336320	TruckVault Inc.	T-FDRANM2-93S-PW	Ford Ranger Pickup Mag 2 Dwr, dimensions: 70.75L x 40.25W	\$4,245.00	\$3,635.52
336320	TruckVault Inc.	T-FDRANM2-99S-PW	Ford Ranger Pickup Mag 2 Dwr, dimensions: 70.75L x 39W	\$4,245.00	\$3,635.52
336320	TruckVault Inc.	T-FDRANMO-19S-PC	Ranger Pickup Mag 2 Dwr Offset5' Short Bed	\$3,145.00	\$2,693.45
336320	TruckVault Inc.	T-FDRANMO-19S-PC-PW	Ranger Pickup Mag Offset Dwr	\$3,945.00	\$3,378.59
336320	TruckVault Inc.	T-FDRANMO-19S-PW	Ranger Pickup Mag Offset Dwr	\$4,245.00	\$3,635.52
336320	TruckVault Inc.	T-FDRANMO-93S	Ranger Pickup Mag OS Dwr	\$3,345.00	\$2,864.74
336320	TruckVault Inc.	T-FDRANMO-93S-PW	Ranger Pickup Mag OS Dwr	\$4,245.00	\$3,635.52
336320	TruckVault Inc.	T-FDRANMO-99S-PW	Ford Ranger Pickup Mag OS Dwr, dimensions: 70.75L x 39W	\$4,245.00	\$3,635.52
336320	TruckVault Inc.	T-FDRANS1-19S-PC-HD	Ranger Pickup Std 1 Dwr5' Short Bed; Drivers Side	\$1,995.00	\$1,708.56
336320	TruckVault Inc.	T-FDRANS1-19S-PC-HD-PW	Ranger Pickup Std 1 Dwr Half Width5', A-Wthr, Drivers Side	\$2,245.00	\$1,922.67
336320	TruckVault Inc.	T-FDRANS1-19S-PC-HP-PW	Ranger Pickup Std 1 Dwr Half Width5', A-Wthr, Passenger Side	\$2,245.00	\$1,922.67
336320	TruckVault Inc.	T-FDRANS2-19S	Ranger Pickup Std 2 DwrShort Bed	\$3,145.00	\$2,693.45
336320	TruckVault Inc.	T-FDRANS2-19S-PC	Ranger Pickup Std 2 Dwr	\$2,945.00	\$2,522.17
336320	TruckVault Inc.	T-FDRANS2-19S-PC-PW	Ranger Pickup Std 2 Dwr	\$3,745.00	\$3,207.30
336320	TruckVault Inc.	T-FDRANS2-19S-PW	Ranger Pickup Std 2 Dwr	\$4,045.00	\$3,464.23
336320	TruckVault Inc.	T-FDRANS2-93S-PW	Ranger Pickup Std 2 Dwr	\$4,145.00	\$3,549.87
336320	TruckVault Inc.	T-FDRANS2-99L-PW	Ford Ranger Pickup Std 2 Dwr, dimensions: 1L x 1W	\$4,645.00	\$3,978.09
336320	TruckVault Inc.	T-FDRANS2-99S-PW	Ford Ranger Pickup Std 2 Dwr, dimensions: 70.75L x 39W	\$4,045.00	\$3,464.23
336320	TruckVault Inc.	T-FDRANSO-19S	Ranger Pickup Std Offset Dwr	\$3,145.00	\$2,693.45
336320	TruckVault Inc.	T-FDRANSO-19S-PC-PL-PW	Ranger Pickup Std OS Dwr5' Short Bed, A-Wthr; Bed Logo	\$3,745.00	\$3,207.30
336320	TruckVault Inc.	T-FDRANSO-19S-PC-PW	Ranger Pickup Std OS Dwr	\$3,745.00	\$3,207.30
336320	TruckVault Inc.	T-FDRANSO-99S-PW	Ford Ranger Pickup Std OS Dwr, dimensions: 70.75L x 39W	\$4,045.00	\$3,464.23
336320	TruckVault Inc.	T-FDRANU1-19S-PC-HP-PW	Ranger Pickup Utility 1 Dwr	\$2,445.00	\$2,093.95
336320	TruckVault Inc.	T-FDRANU2-12S-PW-ZC11503	Ranger PickupUtility 2 Dwr	\$3,695.00	\$3,164.48
336320	TruckVault Inc.	T-FDRANU2-19S	Ranger Pickup Utility 2 DwrShort Bed	\$3,245.00	\$2,779.09
336320	TruckVault Inc.	T-FDRANU2-19S-PC	Ranger Pickup Utility 2 Dwr	\$3,045.00	\$2,607.81
336320	TruckVault Inc.	T-FDRANU2-19S-PC-PW	Ranger Pickup Utility 2 Dwr	\$3,845.00	\$3,292.95
336320	TruckVault Inc.	T-FDRANU2-99S	Ranger Pickup Utility 2 Dwr	\$3,245.00	\$2,779.09
336320	TruckVault Inc.	T-FDRANUO-19S-PC	Ranger Pickup Utility OS Dwr	\$3,045.00	\$2,607.81
336320	TruckVault Inc.	T-FDRT6S1-12S-HD	Ranger T6 Std 1 Dwr Half Width	\$1,995.00	\$1,708.56
336320	TruckVault Inc.	T-FDRT6S2-12S	Ranger T6 Std 2 Dwr	\$2,945.00	\$2,522.17
336320	TruckVault Inc.	T-FDTAXM1-08N	Ford Taurus X Mag 1 Dwr, dimensions: 44L x 40W	\$2,295.00	\$1,965.49
336320	TruckVault Inc.	T-FDTAXM2-08N	Ford Taurus X Mag 2 Dwr, dimensions: 44L x 40W	\$2,845.00	\$2,436.52
336320	TruckVault Inc.	T-FDTAXS1-08N	Ford Taurus X Std 1 Dwr, dimensions: 44L x 40W	\$2,095.00	\$1,794.21
336320	TruckVault Inc.	T-FDTAXS2-08N	Ford Taurus X Std 2 Dwr, dimensions: 0L x 0W	\$2,645.00	\$2,265.24
336320	TruckVault Inc.	T-FDTAXS2-08N-PP	Ford Taurus X Std 2 Dwr, dimensions: 41L x 40W	\$2,645.00	\$2,265.24
336320	TruckVault Inc.	T-FDTCM2-14F	Transit Connect Mag 2 Dwr	\$3,445.00	\$2,950.38
336320	TruckVault Inc.	T-FDTCM2-14F-HT	Transit Connect Mag 2 DwrLWB; Full Length Vault; Heavy Duty Table	\$3,940.00	\$3,374.31
336320	TruckVault Inc.	T-FDTCM2-14F-PT	Transit Connect Mag 2 Dwr	\$3,940.00	\$3,374.31
336320	TruckVault Inc.	T-FDTCM2-14M	Transit Connect Mag 2 DwrLWB; Mid Length Vault	\$2,845.00	\$2,436.52
336320	TruckVault Inc.	T-FDTCM2-14M	Transit Connect Std 2 Dwr	\$2,645.00	\$2,265.24
336320	TruckVault Inc.	T-FDTCM2-14M	Transit Connect Utility 2 DwrLWB; Mid Length Vault	\$2,745.00	\$2,350.88
336320	TruckVault Inc.	T-FDTCM2-02F	Transit Connect Mag 2 Dwr	\$3,045.00	\$2,607.81
336320	TruckVault Inc.	T-FDTCM2-14F	Transit Connect Mag 2 Dwr	\$3,045.00	\$2,607.81
336320	TruckVault Inc.	T-FDTCSS1-14N-ZC9477	Transit Connect Std 1 Dwr	\$2,135.00	\$1,828.46
336320	TruckVault Inc.	T-FDTRAM1-14S	Transit Magnum 1 Dwr	\$2,295.00	\$1,965.49
336320	TruckVault Inc.	T-FDTRAM2-14L	Transit Magnum 2 Dwr	\$3,245.00	\$2,779.09

336320	TruckVault Inc.	T-FDTRAM2-14M	Transit Full Size Van	\$3,245.00	\$2,779.09
336320	TruckVault Inc.	T-FDTRAM2-14N-TR-HT-ZC8326	Transit Mag 2 Dwr Custom	\$4,125.00	\$3,532.75
336320	TruckVault Inc.	T-FDTRAN3-06N-C1-PT-ZC8671	Transit Custom	\$4,815.00	\$4,123.68
336320	TruckVault Inc.	T-FDTRAS1-14N-TR	Transit Std 1 Dwr	\$2,095.00	\$1,794.21
336320	TruckVault Inc.	T-FDTRAS1-14N-TR-C1-ZC8274	Transit Std 1 Dwr	\$2,795.00	\$2,393.70
336320	TruckVault Inc.	T-FDTRAS2-14N-TR	Transit Std 2 Dwr	\$2,645.00	\$2,265.24
336320	TruckVault Inc.	T-FDTRAU1-14N-ZC10772	Transit Full Size VanC10772	\$2,435.00	\$2,085.39
336320	TruckVault Inc.	T-FDTRAU1-15N-HT-ZC10938	Full Size Van CustomC10938	\$3,475.00	\$2,976.07
336320	TruckVault Inc.	T-FDTRAU2-14N-HT-ZC10938	Full Size Van CustomC10938	\$3,475.00	\$2,976.07
336320	TruckVault Inc.	T-FDTRAU2-15N-HT-ZC10938	Full Size Van CustomC10938	\$3,475.00	\$2,976.07
336320	TruckVault Inc.	T-FDTRLM1-14M	Transit LWB Magnum 1 DwrBehind 3rd Row	\$2,435.00	\$2,085.39
336320	TruckVault Inc.	T-FDTRLM1-14S	Transit LWB Magnum 1 Dwr	\$2,025.00	\$1,734.26
336320	TruckVault Inc.	T-FDTRLM2-14L	Full Size Van Mag 2 Dwr	\$3,645.00	\$3,121.66
336320	TruckVault Inc.	T-FDTRSS2-14M-TR-HT	Ford Transit Std 2 DwrSWB 3rd Seat Removed; HD Table	\$3,340.00	\$2,860.45
336320	TruckVault Inc.	T-FDTRXM2-14F	Full Size Van Mag 2 Dwr	\$3,645.00	\$3,121.66
336320	TruckVault Inc.	T-FDTRXS1-14N-ZC8249	Full Size Van Std 1 Dwr	\$1,685.00	\$1,443.07
336320	TruckVault Inc.	T-FDTRXS2-14F	Full Size Van Std 2 Dwr	\$3,445.00	\$2,950.38
336320	TruckVault Inc.	T-FDWINM1-03L	Ford Windstar Mag 1 Dwr, dimensions: 48.5L x 46.5W	\$2,435.00	\$2,085.39
336320	TruckVault Inc.	T-FDWINM1-99L	Ford Windstar Mag 1 Dwr, dimensions: 48.5L x 46.5W	\$2,435.00	\$2,085.39
336320	TruckVault Inc.	T-FDWINM2-03L	Ford Windstar Mag 2 Dwr, dimensions: 48.5L x 46.5W	\$2,985.00	\$2,556.42
336320	TruckVault Inc.	T-FDWINM2-95L	Ford Windstar Mag 2 Dwr, dimensions: 0L x 0W	\$2,985.00	\$2,556.42
336320	TruckVault Inc.	T-FDWINM2-99L	Ford Windstar Mag 2 Dwr, dimensions: 48.5L x 46.5W	\$2,985.00	\$2,556.42
336320	TruckVault Inc.	T-FDWINM2-99S	Ford Windstar Mag 2 Dwr, dimensions: 43L x 47W	\$2,845.00	\$2,436.52
336320	TruckVault Inc.	T-FDWINS1-03L	Ford Windstar Std 1 Dwr, dimensions: 50L x 46.5W	\$2,215.00	\$1,896.98
336320	TruckVault Inc.	T-FDWINS2-03L	Ford Windstar Std 2 Dwr, dimensions: 50L x 46.5W	\$2,755.00	\$2,359.45
336320	TruckVault Inc.	T-FDWINS2-99L	Ford Windstar Std 2 Dwr, dimensions: 48.5L x 46.5W	\$2,755.00	\$2,359.45
336320	TruckVault Inc.	T-FDWINS2-99S	Ford Windstar Std 2 Dwr, dimensions: 43L x 47W	\$2,645.00	\$2,265.24
336320	TruckVault Inc.	T-FI50LU1-14N	Fiat 500L	\$1,595.00	\$1,365.99
336320	TruckVault Inc.	T-GMACAM1-07N	Acadia	\$2,295.00	\$1,965.49
336320	TruckVault Inc.	T-GMACAM1-07N-ZC8356	Acadia Mag 1 Dwr	\$2,185.00	\$1,871.28
336320	TruckVault Inc.	T-GMACAM1-17N	Acadia	\$2,295.00	\$1,965.49
336320	TruckVault Inc.	T-GMACAM1-17N-HG	Acadia Elevated Vault	\$2,045.00	\$1,751.39
336320	TruckVault Inc.	T-GMACAM2-07N	Acadia	\$2,845.00	\$2,436.52
336320	TruckVault Inc.	T-GMACAM2-07N-PP	Acadia	\$2,845.00	\$2,436.52
336320	TruckVault Inc.	T-GMACAM2-17N	Acadia	\$2,845.00	\$2,436.52
336320	TruckVault Inc.	T-GMACAMO-07N	Acadia	\$2,845.00	\$2,436.52
336320	TruckVault Inc.	T-GMACAMO-07N-PT	Acadia	\$3,540.00	\$3,031.74
336320	TruckVault Inc.	T-GMACAMO-17N	Acadia Mag OS Dwr	\$2,845.00	\$2,436.52
336320	TruckVault Inc.	T-GMACANO-07N-Z1	Acadia	\$2,305.00	\$1,974.06
336320	TruckVault Inc.	T-GMACANO-17N-Z1	Acadia	\$2,305.00	\$1,974.06
336320	TruckVault Inc.	T-GMACAS1-07N	Acadia	\$2,095.00	\$1,794.21
336320	TruckVault Inc.	T-GMACAS1-17N	Acadia	\$2,095.00	\$1,794.21
336320	TruckVault Inc.	T-GMACAS1-17N-HG	Acadia Elevated Vault	\$1,845.00	\$1,580.10
336320	TruckVault Inc.	T-GMACAS1-17S	Acadia Std 1 Drawer	\$1,415.00	\$1,211.84
336320	TruckVault Inc.	T-GMACAS2-07N	Acadia	\$2,645.00	\$2,265.24
336320	TruckVault Inc.	T-GMACAS2-17N	Acadia	\$2,645.00	\$2,265.24
336320	TruckVault Inc.	T-GMACASO-07N	Acadia	\$2,645.00	\$2,265.24
336320	TruckVault Inc.	T-GMACASO-17N	Acadia Std OS Dwr	\$2,645.00	\$2,265.24
336320	TruckVault Inc.	T-GMACAU1-17N	Acadia	\$2,195.00	\$1,879.85
336320	TruckVault Inc.	T-GMACAU1-17N-HG	Acadia Elevated Vault	\$1,855.00	\$1,588.66
336320	TruckVault Inc.	T-GMACAU1-17N-ZC11184	AcadiaUtility 1 Drawer	\$2,015.00	\$1,725.69
336320	TruckVault Inc.	T-GMACAU2-17N	Acadia	\$2,745.00	\$2,350.88
336320	TruckVault Inc.	T-GMACAUO-17N	Acadia	\$2,745.00	\$2,350.88
336320	TruckVault Inc.	T-GMCANM1-04S-PC-HD	Canyon Mag 1 Dwr Half Width	\$2,195.00	\$1,879.85
336320	TruckVault Inc.	T-GMCANM1-15S-PC-HP	Canyon Mag 1 Dwr Half Width	\$2,195.00	\$1,879.85
336320	TruckVault Inc.	T-GMCANM1-15S-PC-PW-Z1	Canyon Pickup Custom	\$2,645.00	\$2,265.24
336320	TruckVault Inc.	T-GMCANM1-15S-PC-Z1	Canyon Mag 1 Dwr Cust Width	\$1,925.00	\$1,648.61
336320	TruckVault Inc.	T-GMCANM2-04S	Canyon Pickup Mag 2 Dwr	\$3,345.00	\$2,864.74
336320	TruckVault Inc.	T-GMCANM2-04S-PC	Canyon Pickup Mag 2 Dwr	\$3,145.00	\$2,693.45
336320	TruckVault Inc.	T-GMCANM2-04S-PC-PW	Canyon Pickup Mag 2 Dwr	\$3,945.00	\$3,378.59
336320	TruckVault Inc.	T-GMCANM2-04S-PW	Canyon Pickup Mag 2 Dwr	\$4,245.00	\$3,635.52
336320	TruckVault Inc.	T-GMCANM2-15S	Canyon Pickup Mag 2 Dwr	\$3,345.00	\$2,864.74
336320	TruckVault Inc.	T-GMCANM2-15S-PC	Canyon Pickup Mag 2 Dwr	\$3,145.00	\$2,693.45
336320	TruckVault Inc.	T-GMCANM2-15S-PC-PW	Canyon Pickup Mag 2 Dwr	\$3,945.00	\$3,378.59
336320	TruckVault Inc.	T-GMCANM2-15S-PW	Canyon Pickup Mag 2 Dwr	\$4,245.00	\$3,635.52
336320	TruckVault Inc.	T-GMCANMO-04S-PC	Canyon Pickup Mag Offset	\$3,145.00	\$2,693.45
336320	TruckVault Inc.	T-GMCANMO-04S-PC-PW	Canyon Pickup Mag Offset	\$3,945.00	\$3,378.59
336320	TruckVault Inc.	T-GMCANMO-15S-PC-PW	Canyon Pickup Mag Offset Dwr	\$3,945.00	\$3,378.59
336320	TruckVault Inc.	T-GMCANMO-15S-PW	Canyon Pickup Mag Offset Dwr	\$4,245.00	\$3,635.52

336320	TruckVault Inc.	T-GMCANS1-15S-PC-PL-HD	Canyon Pickup Std 1 Dwr5' Short Bed; Logo Driver's Side	\$1,995.00	\$1,708.56
336320	TruckVault Inc.	T-GMCANS1-15S-PL-HD-PW	Canyon Pickup Std 1 Dwr	\$2,545.00	\$2,179.60
336320	TruckVault Inc.	T-GMCANS2-04S	Canyon Pickup Std 2 Dwr	\$3,145.00	\$2,693.45
336320	TruckVault Inc.	T-GMCANS2-04S-PC	Canyon Pickup Std 2 Dwr	\$2,945.00	\$2,522.17
336320	TruckVault Inc.	T-GMCANS2-04S-PC-PW	Canyon Pickup Std 2 Dwr	\$3,745.00	\$3,207.30
336320	TruckVault Inc.	T-GMCANS2-04S-PW	Canyon Pickup Std 2 Dwr	\$4,045.00	\$3,464.23
336320	TruckVault Inc.	T-GMCANS2-15S	Canyon Pickup Std 2 Dwr	\$3,145.00	\$2,693.45
336320	TruckVault Inc.	T-GMCANS2-15S-PC	Canyon Pickup Std 2 Dwr	\$2,945.00	\$2,522.17
336320	TruckVault Inc.	T-GMCANS2-15S-PC-PL	Canyon Pickup Std 2 Dwr	\$2,945.00	\$2,522.17
336320	TruckVault Inc.	T-GMCANS2-15S-PC-PW	Canyon Pickup Std 2 Dwr	\$3,745.00	\$3,207.30
336320	TruckVault Inc.	T-GMCANS2-15S-PW	Canyon Pickup Std 2 Dwr	\$4,345.00	\$3,721.16
336320	TruckVault Inc.	T-GMCANS2-15S-ZC8786	Canyon Pickup Std 2 Dwr	\$2,605.00	\$2,230.98
336320	TruckVault Inc.	T-GMCANSO-04S-PC	Canyon Pickup Std OS Dwr	\$2,945.00	\$2,522.17
336320	TruckVault Inc.	T-GMCANSO-15S	Canyon Pickup Std OS Dwr	\$4,045.00	\$3,464.23
336320	TruckVault Inc.	T-GMCANSO-15S-PC	Canyon Pickup Std OS Dwr	\$2,945.00	\$2,522.17
336320	TruckVault Inc.	T-GMCANSO-15S-PC-PL-PW	Canyon Pickup Std Offset Dwr	\$3,745.00	\$3,207.30
336320	TruckVault Inc.	T-GMCANU2-15S-PC	Canyon Pickup Utility 2 Dwr	\$3,045.00	\$2,607.81
336320	TruckVault Inc.	T-GMCANUO-15S-PC	Canyon Pickup Utility OS Dwr	\$3,045.00	\$2,607.81
336320	TruckVault Inc.	T-GMCANUO-15S-PW	Canyon Pickup Offset 2 DwrShort Bed, All-Wthr	\$4,145.00	\$3,549.87
336320	TruckVault Inc.	T-GMENVM1-02N	Envoy Mag 1 Dwr	\$2,095.00	\$1,794.21
336320	TruckVault Inc.	T-GMENVM2-02N	Envoy Mag 2 Dwr	\$2,645.00	\$2,265.24
336320	TruckVault Inc.	T-GMENVS1-02N	Envoy Std 1 Dwr	\$1,895.00	\$1,622.92
336320	TruckVault Inc.	T-GMENVS2-02N	Envoy Std 2 Dwr	\$2,445.00	\$2,093.95
336320	TruckVault Inc.	T-GMEXLM1-02N	Envoy XL Mag 1 Dwr	\$2,295.00	\$1,965.49
336320	TruckVault Inc.	T-GMEXLM1-02N-TR	Envoy XL Mag 1 Dwr	\$2,295.00	\$1,965.49
336320	TruckVault Inc.	T-GMEXLM2-02N	Envoy XL Mag 2 Dwr	\$2,845.00	\$2,436.52
336320	TruckVault Inc.	T-GMEXLM2-02N-TR	Envoy XL Mag 2 Dwr	\$2,845.00	\$2,436.52
336320	TruckVault Inc.	T-GMEXLM2-02N-TR-PT	Envoy XL Mag 2 Dwr	\$3,540.00	\$3,031.74
336320	TruckVault Inc.	T-GMEXLS1-02N	Envoy XL Std 1 Dwr	\$2,095.00	\$1,794.21
336320	TruckVault Inc.	T-GMEXLS2-02N	Envoy XL Std 2 Dwr	\$2,645.00	\$2,265.24
336320	TruckVault Inc.	T-GMH3TM1-09N-HD-PW	Hummer H3 SUT Mag 1 Dwr Half W	\$2,545.00	\$2,179.60
336320	TruckVault Inc.	T-GMH3TM2-09N	Hummer H3 SUT Mag 2 Dwr	\$3,045.00	\$2,607.81
336320	TruckVault Inc.	T-GMH3TS2-09N	Hummer H3 SUT Std 2 Dwr	\$2,845.00	\$2,436.52
336320	TruckVault Inc.	T-GMH3TS2-09N-PW	H3 Std 2 Dwr	\$3,745.00	\$3,207.30
336320	TruckVault Inc.	T-GMHH2M1-02N	Hummer H2 Mag 1 Dwr	\$2,095.00	\$1,794.21
336320	TruckVault Inc.	T-GMHH2M1-02N-PW	Hummer H2 Mag 1 DwrSpare Out All-Weather	\$2,395.00	\$2,051.13
336320	TruckVault Inc.	T-GMHH2M2-02N	Hummer H2 Mag 2 DwrSpare Out	\$2,645.00	\$2,265.24
336320	TruckVault Inc.	T-GMHH2M2-02N-PW	Hummer H2 Mag 2 DwrSpare Out All-Weather	\$2,845.00	\$2,436.52
336320	TruckVault Inc.	T-GMHH2S1-02N	Hummer H2 Std 1 Dwr	\$2,095.00	\$1,794.21
336320	TruckVault Inc.	T-GMHH2S1-02N-SI	Hummer H2 Std 1 Dwr	\$2,495.00	\$2,136.78
336320	TruckVault Inc.	T-GMHH2S1-02N-Z2	Hummer H2 Std 1 Dwr C4745	\$1,975.00	\$1,691.44
336320	TruckVault Inc.	T-GMHH2S2-02N	Hummer H2 Std 2 Dwr	\$2,645.00	\$2,265.24
336320	TruckVault Inc.	T-GMHH2S2-02N-PW	Hummer H2 Std 2 Dwr	\$2,645.00	\$2,265.24
336320	TruckVault Inc.	T-GMHH2SO-02N	Hummer H2 Std OS Dwr	\$2,645.00	\$2,265.24
336320	TruckVault Inc.	T-GMHH2U1-02N	Hummer H2 Utility 1 Dwr	\$2,195.00	\$1,879.85
336320	TruckVault Inc.	T-GMHH2U1-02N-HT	Hummer H2 Utility 1 Dwr	\$2,690.00	\$2,303.78
336320	TruckVault Inc.	T-GMHH2U2-02N	Hummer H2 Utility 2 DwrSpare Out	\$2,745.00	\$2,350.88
336320	TruckVault Inc.	T-GMHH3M1-06N	H3 Mag 1 Dwr	\$2,095.00	\$1,794.21
336320	TruckVault Inc.	T-GMHH3M1-06N-PT	H3 Mag 1 Dwr	\$2,790.00	\$2,389.42
336320	TruckVault Inc.	T-GMHH3M2-06N	H3 Mag 2 Dwr	\$2,645.00	\$2,265.24
336320	TruckVault Inc.	T-GMHH3M2-06N-PW	H3 Mag 2 DwrAll-Weather	\$2,845.00	\$2,436.52
336320	TruckVault Inc.	T-GMHH3MO-06N	H3 Mag Offset Dwr	\$2,645.00	\$2,265.24
336320	TruckVault Inc.	T-GMHH3S1-06N	H3 Std 1 Dwr	\$1,895.00	\$1,622.92
336320	TruckVault Inc.	T-GMHH3S1-06N-PT	H3 Std 1 Dwr	\$2,590.00	\$2,218.14
336320	TruckVault Inc.	T-GMHH3S2-06N	H3 Std 2 Dwr	\$2,445.00	\$2,093.95
336320	TruckVault Inc.	T-GMHH3S2-06N-PT	H3 Std 2 Dwr	\$3,140.00	\$2,689.17
336320	TruckVault Inc.	T-GMHH3SO-06N	H3 Std Offset	\$2,445.00	\$2,093.95
336320	TruckVault Inc.	T-GMHH3U1-06N	H3 Utility 1 Dwr	\$1,925.00	\$1,648.61
336320	TruckVault Inc.	T-GMHH3U2-06N	H3 Utility 2 Dwr	\$2,545.00	\$2,179.60
336320	TruckVault Inc.	T-GMHHTM1-05N	Hummer H2 SUT Mag 1 Dwr	\$2,095.00	\$1,794.21
336320	TruckVault Inc.	T-GMHHTM1-05N-PW	Hummer H2 SUT Mag 1 DwrA-Wthr	\$2,795.00	\$2,393.70
336320	TruckVault Inc.	T-GMHHTS1-05N	Hummer H2 SUT Std 1 Dwr	\$1,895.00	\$1,622.92
336320	TruckVault Inc.	T-GMHHTS1-05N-PW	Hummer H2 SUT Std 1 DwrA-Wthr	\$2,625.00	\$2,248.11
336320	TruckVault Inc.	T-GMHHTS2-05N	Hummer H2 SUT Std 2 Dwr	\$2,445.00	\$2,093.95
336320	TruckVault Inc.	T-GMHHTSO-05N	Hummer H2 SUT Std OS Dwr	\$2,445.00	\$2,093.95
336320	TruckVault Inc.	T-GMHHTUO-05N-HT	Hummer H2 SUT Utility OS Dwr	\$3,240.00	\$2,774.81
336320	TruckVault Inc.	T-GMKSEM2-88L-PW	Sierra Pickup Mag 2 DwrLong Bed, All-Weather	\$4,945.00	\$4,235.01
336320	TruckVault Inc.	T-GMKSEM2-99L	Sierra Pickup Mag 2 Dwr	\$3,945.00	\$3,378.59
336320	TruckVault Inc.	T-GMKSEM2-99L-PW	Sierra Pickup Mag 2 DwrLong Bed, All-Weather	\$4,945.00	\$4,235.01

336320	TruckVault Inc.	T-GMKSEM2-99S	Sierra Pickup Mag 2 Dwr	\$3,745.00	\$3,207.30
336320	TruckVault Inc.	T-GMKSEM2-99S-PT	Sierra Pickup Mag 2 Dwr	\$4,440.00	\$3,802.52
336320	TruckVault Inc.	T-GMKSEM2-99S-PW	Sierra Pickup Mag 2 Dwr	\$4,645.00	\$3,978.09
336320	TruckVault Inc.	T-GMKSEMO-88L	Sierra Pickup Mag Offset Dwr	\$3,645.00	\$3,121.66
336320	TruckVault Inc.	T-GMKSEMO-88S	Sierra Pickup Mag OS Dwr	\$3,445.00	\$2,950.38
336320	TruckVault Inc.	T-GMKSEMO-88S-PW	Sierra Pickup Mag OS Dwr	\$4,645.00	\$3,978.09
336320	TruckVault Inc.	T-GMKSEMO-99L	Sierra Pickup Mag Offset Dwr	\$3,645.00	\$3,121.66
336320	TruckVault Inc.	T-GMKSEMO-99L-PW	Sierra Pickup Mag Offset DwrLong Bed, All-Wthr	\$4,945.00	\$4,235.01
336320	TruckVault Inc.	T-GMKSEMO-99S	Sierra Pickup Mag Offset Dwr	\$3,445.00	\$2,950.38
336320	TruckVault Inc.	T-GMKSEMO-99S-PT	Sierra Pickup Mag Offset Dwr	\$3,940.00	\$3,374.31
336320	TruckVault Inc.	T-GMKSEMO-99S-PW	Sierra Pickup Mag OS Dwr	\$4,645.00	\$3,978.09
336320	TruckVault Inc.	T-GMKSES2-88L	Sierra Pickup Std 2 Dwr	\$3,745.00	\$3,207.30
336320	TruckVault Inc.	T-GMKSES2-88S	Sierra Pickup Std 2 Dwr	\$3,545.00	\$3,036.02
336320	TruckVault Inc.	T-GMKSES2-88S-PW	Sierra Pickup Std 2 Dwr	\$4,445.00	\$3,806.80
336320	TruckVault Inc.	T-GMKSES2-99L	Sierra Pickup Std 2 Dwr	\$3,745.00	\$3,207.30
336320	TruckVault Inc.	T-GMKSES2-99L-PW	Sierra Pickup Std 2 DwrLong Bed, A-Wthr	\$4,745.00	\$4,063.73
336320	TruckVault Inc.	T-GMKSES2-99S	Sierra Pickup Std 2 Dwr	\$3,545.00	\$3,036.02
336320	TruckVault Inc.	T-GMKSES2-99S-PT	Sierra Pickup Std 2 Dwr	\$4,240.00	\$3,631.23
336320	TruckVault Inc.	T-GMKSES2-99S-PW	Sierra Pickup Std 2 Dwr	\$4,445.00	\$3,806.80
336320	TruckVault Inc.	T-GMKSES0-88L	Sierra Pickup Std OS Dwr	\$3,745.00	\$3,207.30
336320	TruckVault Inc.	T-GMKSES0-88S-PW	Sierra Pickup Std OS Dwr	\$4,445.00	\$3,806.80
336320	TruckVault Inc.	T-GMKSES0-99L	Sierra Pickup Std OS Dwr	\$3,445.00	\$2,950.38
336320	TruckVault Inc.	T-GMKSES0-99L-PW	Sierra Pickup Std OS DwrLong Bed, A-Wthr	\$4,745.00	\$4,063.73
336320	TruckVault Inc.	T-GMKSES0-99S	Sierra Pickup Std OS Dwr	\$3,245.00	\$2,779.09
336320	TruckVault Inc.	T-GMKSES0-99S-PT	Sierra Pickup Std OS Dwr	\$3,940.00	\$3,374.31
336320	TruckVault Inc.	T-GMKSES0-99S-PW	Sierra Pickup Std OS Dwr	\$4,445.00	\$3,806.80
336320	TruckVault Inc.	T-GMSAFM2-86S	Safari Van Mag 2 Dwr	\$2,845.00	\$2,436.52
336320	TruckVault Inc.	T-GMSAFS1-02S	Safari Std 1 Dwr	\$1,895.00	\$1,622.92
336320	TruckVault Inc.	T-GMSAFS1-86S	Safari Std 1 Dwr	\$1,895.00	\$1,622.92
336320	TruckVault Inc.	T-GMSAFS2-86S	Safari Van Std 2 Dwr	\$2,845.00	\$2,436.52
336320	TruckVault Inc.	T-GMSAVM2-98L	Savana Mag 2 Dwr	\$3,245.00	\$2,779.09
336320	TruckVault Inc.	T-GMSAVN1-98N-HT-Z1	Savana Custom	\$3,185.00	\$2,727.71
336320	TruckVault Inc.	T-GMSAVS2-03L	Savana Std 2 Dwr	\$3,445.00	\$2,950.38
336320	TruckVault Inc.	T-GMSAVS2-98L	Savana Std 2 Dwr	\$3,045.00	\$2,607.81
336320	TruckVault Inc.	T-GMSAVU2-03F	Savana Utility 2 Dwr	\$3,095.00	\$2,650.63
336320	TruckVault Inc.	T-GMSJIM1-02N-D2	S-15 Jimmy Mag 1 Dwr	\$2,795.00	\$2,393.70
336320	TruckVault Inc.	T-GMSJIM1-95N	S-15 Jimmy Mag 1 Dwr	\$2,095.00	\$1,794.21
336320	TruckVault Inc.	T-GMSJIS1-01N-D2	S-15 Jimmy Std 1 Dwr	\$2,795.00	\$2,393.70
336320	TruckVault Inc.	T-GMSJIS1-95N	S-15 Jimmy Std 1 Dwr	\$1,895.00	\$1,622.92
336320	TruckVault Inc.	T-GMSRAM1-07S-HD-PW	Sierra Mag 1 Dwr Half Width	\$3,045.00	\$2,607.81
336320	TruckVault Inc.	T-GMSRAM1-07S-HP	Sierra Mag 1 Dwr Half Width	\$2,545.00	\$2,179.60
336320	TruckVault Inc.	T-GMSRAM1-07S-HP-PW	Sierra Mag 1 Dwr Half Width	\$3,045.00	\$2,607.81
336320	TruckVault Inc.	T-GMSRAM1-07S-PC-HD-PW	Sierra Mag 1 Dwr Half Width	\$2,745.00	\$2,350.88
336320	TruckVault Inc.	T-GMSRAM1-07S-PC-HP	Sierra Mag 1 Dwr Half Width	\$2,495.00	\$2,136.78
336320	TruckVault Inc.	T-GMSRAM1-07S-PC-HP-PW	Sierra Mag 1 Dwr Half Width	\$2,745.00	\$2,350.88
336320	TruckVault Inc.	T-GMSRAM1-07S-PC-HT-HD-PW	Sierra Mag 1 Dwr Half Width	\$3,440.00	\$2,946.10
336320	TruckVault Inc.	T-GMSRAM1-19S-HD	Sierra Mag 1 Dwr Half Width6' 6" Bed, Driver's Side	\$2,545.00	\$2,179.60
336320	TruckVault Inc.	T-GMSRAM1-19S-PC-HD	Sierra Mag 1 Dwr Half Width5' 8" Bed, Drivers Side FLAG	\$2,435.00	\$2,085.39
336320	TruckVault Inc.	T-GMSRAM1-19S-PC-HP	Sierra Mag 1 Dwr Half Width	\$2,225.00	\$1,905.54
336320	TruckVault Inc.	T-GMSRAM1-19S-PC-HT-HD-PW	Sierra Mag 1 Dwr Half Width	\$3,440.00	\$2,946.10
336320	TruckVault Inc.	T-GMSRAM1-20S-P5-CB-HP-PW	Sierra Mag 1 Dwr Half Width6'6", All Wthr; Passanger Side Carbon	\$3,045.00	\$2,607.81
336320	TruckVault Inc.	T-GMSRAM2-04S-PC	Sierra Pickup Mag 2 Dwr	\$3,545.00	\$3,036.02
336320	TruckVault Inc.	T-GMSRAM2-04S-PC-PW	Sierra Pickup Mag 2 Dwr	\$4,345.00	\$3,721.16
336320	TruckVault Inc.	T-GMSRAM2-07L	Sierra Pickup Mag 2 Dwr	\$3,945.00	\$3,378.59
336320	TruckVault Inc.	T-GMSRAM2-07L-PW	Sierra Pickup Mag 2 Dwr8' Long Bed (New), All Wthr	\$4,945.00	\$4,235.01
336320	TruckVault Inc.	T-GMSRAM2-07S	Sierra Pickup Mag 2 Dwr	\$3,745.00	\$3,207.30
336320	TruckVault Inc.	T-GMSRAM2-07S-HT	Sierra Pickup Mag 2 Dwr	\$4,440.00	\$3,802.52
336320	TruckVault Inc.	T-GMSRAM2-07S-HT-PW	Sierra Pickup Mag 2 Dwr	\$5,340.00	\$4,573.30
336320	TruckVault Inc.	T-GMSRAM2-07S-P5-C3-PW-ZC11842	SierraHD PU CUST Custom 2 Dwr	\$4,245.00	\$3,635.52
336320	TruckVault Inc.	T-GMSRAM2-07S-PC	Sierra Pickup Mag 2 Dwr	\$3,545.00	\$3,036.02
336320	TruckVault Inc.	T-GMSRAM2-07S-PC-PW	Sierra Pickup Mag 2 Dwr	\$4,345.00	\$3,721.16
336320	TruckVault Inc.	T-GMSRAM2-07S-PC-PW-Z2	Sierra Pickup Mag 2 Dwr	\$4,185.00	\$3,584.13
336320	TruckVault Inc.	T-GMSRAM2-07S-PW	Sierra Pickup Mag 2 Dwr	\$4,645.00	\$3,978.09
336320	TruckVault Inc.	T-GMSRAM2-07S-RX-PW	Sierra Pickup Mag 2 Dwr6' 6" Bed, A-Wthr Shortened for Retrax	\$4,345.00	\$3,721.16
336320	TruckVault Inc.	T-GMSRAM2-19L	Sierra Pickup Mag Dwr	\$3,945.00	\$3,378.59
336320	TruckVault Inc.	T-GMSRAM2-19L-PW	Sierra Pickup Mag Dwr	\$4,945.00	\$4,235.01
336320	TruckVault Inc.	T-GMSRAM2-19S	Sierra Pickup Mag 2 Dwr	\$3,745.00	\$3,207.30

336320	TruckVault Inc.	T-GMSRAM2-19S-PC	Sierra Pickup Mag 2 Dwr	\$3,545.00	\$3,036.02
336320	TruckVault Inc.	T-GMSRAM2-19S-PC-PW	Sierra Pickup Mag 2 Dwr	\$4,345.00	\$3,721.16
336320	TruckVault Inc.	T-GMSRAM2-19S-PF-PW	Sierra Pickup Mag 2 Dwr	\$4,345.00	\$3,721.16
336320	TruckVault Inc.	T-GMSRAM2-19S-PW	Sierra Pickup Mag 2 Dwr	\$4,645.00	\$3,978.09
336320	TruckVault Inc.	T-GMSRAM2-20L-P5-PW	Sierra Pickup Mag 2 Dwr	\$5,225.00	\$4,474.81
336320	TruckVault Inc.	T-GMSRAM2-20S-P5	Sierra Pickup Mag 2 Dwr6' 8" Bed	\$3,745.00	\$3,207.30
336320	TruckVault Inc.	T-GMSRAM2-20S-P5-PF	Sierra Pickup Mag 2 Dwr	\$3,545.00	\$3,036.02
336320	TruckVault Inc.	T-GMSRAM2-20S-P5-PW	Sierra Pickup Mag 2 Dwr6' 6" Bed, A-Wthr 2500	\$4,645.00	\$3,978.09
336320	TruckVault Inc.	T-GMSRAM2-20S-P5-RX	Sierra Pickup Mag 2 Dwr	\$3,545.00	\$3,036.02
336320	TruckVault Inc.	T-GMSRAM2-20S-P5-RX-PW	Sierra 2500 Pickup Mag 2 Dwr	\$4,345.00	\$3,721.16
336320	TruckVault Inc.	T-GMSRAM3-07L-C2-PW-Z1	Sierra Pickup Mag 3 Dwr	\$5,445.00	\$4,663.22
336320	TruckVault Inc.	T-GMSRAM3-07S-C2-PW-ZC10691	Sierra Pickup Mag 3 DwrGooseneck; All Weather; C10691	\$5,145.00	\$4,406.30
336320	TruckVault Inc.	T-GMSRAMO-04S-PC	Sierra Pickup Mag OS Dwr	\$3,245.00	\$2,779.09
336320	TruckVault Inc.	T-GMSRAMO-04S-PC-PW	Sierra Pickup Mag OS Dwr	\$4,345.00	\$3,721.16
336320	TruckVault Inc.	T-GMSRAMO-07L	Sierra Pickup Mag Offset Dwr	\$3,645.00	\$3,121.66
336320	TruckVault Inc.	T-GMSRAMO-07L-PW	Sierra Pickup Mag Offset Dwr8" Bed, All-Wthr	\$4,945.00	\$4,235.01
336320	TruckVault Inc.	T-GMSRAMO-07S	Sierra Pickup Mag Offset Dwr	\$3,445.00	\$2,950.38
336320	TruckVault Inc.	T-GMSRAMO-07S-PC	Sierra Pickup Mag Offset Dwr	\$3,245.00	\$2,779.09
336320	TruckVault Inc.	T-GMSRAMO-07S-PC-PW	Sierra Pickup Mag OS Dwr	\$4,345.00	\$3,721.16
336320	TruckVault Inc.	T-GMSRAMO-07S-PW	Sierra Pickup Mag OS Dwr	\$4,645.00	\$3,978.09
336320	TruckVault Inc.	T-GMSRAMO-07S-Z1	Sierra Pickup Mag Reverse Offset Dwr	\$3,525.00	\$3,018.89
336320	TruckVault Inc.	T-GMSRAMO-19S-PC-PW	Sierra Pickup Mag OS Dwr	\$4,345.00	\$3,721.16
336320	TruckVault Inc.	T-GMSRAMO-19S-PF-PW	Sierra Pickup Mag OS Dwr	\$4,345.00	\$3,721.16
336320	TruckVault Inc.	T-GMSRAMO-20S-P5	Sierra Pickup Mag Offset Dwr6' 8" Bed	\$3,445.00	\$2,950.38
336320	TruckVault Inc.	T-GMSRAMO-20S-P5-PL-PW	Sierra 2500/3500 Mag OS Dwr6' 8" Short Bed; All-Weather	\$4,645.00	\$3,978.09
336320	TruckVault Inc.	T-GMSRAMO-20S-P5-PW	Sierra Pickup Mag OS Dwr6' 8" Bed, A-Wthr	\$4,645.00	\$3,978.09
336320	TruckVault Inc.	T-GMSRAN1-07S-PW-ZC10465A	Sierra Pickup Custom 1 DwrC10465A	\$3,635.00	\$3,113.10
336320	TruckVault Inc.	T-GMSRAN2-07L-PW-Z1	Sierra Pickup CUST 2 Dwr	\$4,625.00	\$3,960.96
336320	TruckVault Inc.	T-GMSRAN2-07S-PW-Z1	Sierra Pickup CUST 2 Dwr	\$4,185.00	\$3,584.13
336320	TruckVault Inc.	T-GMSRAS1-07S-HD	Sierra Std 1 Dwr Half Width	\$2,495.00	\$2,136.78
336320	TruckVault Inc.	T-GMSRAS1-07S-HP	Sierra Std 1 Dwr Half Width	\$2,325.00	\$1,991.18
336320	TruckVault Inc.	T-GMSRAS1-07S-HP-PW	Sierra Std 1 Dwr Half Width	\$2,845.00	\$2,436.52
336320	TruckVault Inc.	T-GMSRAS1-07S-PC-HD	Sierra Std 1 Dwr Half Width	\$2,215.00	\$1,896.98
336320	TruckVault Inc.	T-GMSRAS1-15S-PC-PL-HD-PW	Sierra Std 1 Dwr Half Width	\$2,545.00	\$2,179.60
336320	TruckVault Inc.	T-GMSRAS1-15S-PL-HD-PW	Sierra Std 1 Dwr Half Width	\$2,845.00	\$2,436.52
336320	TruckVault Inc.	T-GMSRAS1-19S-HP	Sierra Std 1 Dwr Half Width	\$2,325.00	\$1,991.18
336320	TruckVault Inc.	T-GMSRAS1-19S-HP-PW	Sierra Std 1 Dwr Half Width	\$2,845.00	\$2,436.52
336320	TruckVault Inc.	T-GMSRAS1-19S-PC-HP	Sierra Std 1 Dwr Half Width5' 8" Bed, Passenger Side	\$2,215.00	\$1,896.98
336320	TruckVault Inc.	T-GMSRAS1-19S-PC-HP-PW	Sierra Std 1 Dwr Half Width	\$2,545.00	\$2,179.60
336320	TruckVault Inc.	T-GMSRAS1-19S-PC-PW-ZC10805	Sierra Pickup Std 2 Dwr5' 8" Bed, Crew Cab, A-Wthr	\$2,225.00	\$1,905.54
336320	TruckVault Inc.	T-GMSRAS1-20S-P5-HD-PW	Sierra Std 1 Dwr Half Width	\$2,825.00	\$2,419.40
336320	TruckVault Inc.	T-GMSRAS1-20S-P5-HP-PW	Sierra Std 1 Dwr Half Width	\$2,825.00	\$2,419.40
336320	TruckVault Inc.	T-GMSRAS1-20S-P5-PL-HD	Sierra HD Std1 Dwr Half Width	\$2,125.00	\$1,819.90
336320	TruckVault Inc.	T-GMSRAS1-20S-P5-PL-HP	Sierra HD Std1 Dwr Half Width	\$2,125.00	\$1,819.90
336320	TruckVault Inc.	T-GMSRAS2-04S-PC	Sierra Pickup Std 2 Dwr	\$3,345.00	\$2,864.74
336320	TruckVault Inc.	T-GMSRAS2-04S-PC-PW	Sierra Pickup Std 2 Dwr	\$4,145.00	\$3,549.87
336320	TruckVault Inc.	T-GMSRAS2-07L	Sierra Pickup Std 2 Dwr	\$3,745.00	\$3,207.30
336320	TruckVault Inc.	T-GMSRAS2-07L-PW	Sierra Pickup Std 2 Dwr8' Long Bed, A-Wthr (New)	\$4,745.00	\$4,063.73
336320	TruckVault Inc.	T-GMSRAS2-07S	Sierra Pickup Std 2 Dwr	\$3,545.00	\$3,036.02
336320	TruckVault Inc.	T-GMSRAS2-07S-PC	Sierra Pickup Std 2 Dwr	\$3,345.00	\$2,864.74
336320	TruckVault Inc.	T-GMSRAS2-07S-PC-PT	Sierra Pickup Std 2 Dwr	\$4,040.00	\$3,459.95
336320	TruckVault Inc.	T-GMSRAS2-07S-PC-PW	Sierra Pickup Std 2 Dwr	\$4,145.00	\$3,549.87
336320	TruckVault Inc.	T-GMSRAS2-07S-PT	Sierra Pickup Std 2 Dwr	\$4,040.00	\$3,459.95
336320	TruckVault Inc.	T-GMSRAS2-07S-PW	Sierra Pickup Std 2 Dwr	\$4,445.00	\$3,806.80
336320	TruckVault Inc.	T-GMSRAS2-07S-PW-Z2	Sierra Pickup Std 2 Dwr	\$3,965.00	\$3,395.72
336320	TruckVault Inc.	T-GMSRAS2-07S-RX-PW	Sierra Pickup Std 2 DwrShort Bed, A-Wthr Retrax	\$4,145.00	\$3,549.87
336320	TruckVault Inc.	T-GMSRAS2-15L-PL	Sierra Pickup Std 2 Dwr	\$3,745.00	\$3,207.30
336320	TruckVault Inc.	T-GMSRAS2-15L-PL-PW	Sierra Pickup Std 2 Dwr	\$4,745.00	\$4,063.73
336320	TruckVault Inc.	T-GMSRAS2-15S-PC-PL	Sierra Pickup Std 2 Dwr	\$3,345.00	\$2,864.74
336320	TruckVault Inc.	T-GMSRAS2-15S-PC-PL-PW	Sierra Pickup Std 2 Dwr	\$4,145.00	\$3,549.87
336320	TruckVault Inc.	T-GMSRAS2-15S-PC-PL-RX	Sierra Pickup Std 2 Dwr Retrax5' 8" Bed, Crew Cab; Bed Spray	\$3,145.00	\$2,693.45
336320	TruckVault Inc.	T-GMSRAS2-15S-PC-PL-RX-PW	Sierra Pickup Std 2 Dwr5' 8" Bed, Crew, A-Wthr, Retrax	\$3,845.00	\$3,292.95
336320	TruckVault Inc.	T-GMSRAS2-15S-PL	Sierra Pickup Std 2 Dwr	\$3,545.00	\$3,036.02
336320	TruckVault Inc.	T-GMSRAS2-15S-PL-PW	Sierra Pickup Std 2 Dwr	\$4,445.00	\$3,806.80
336320	TruckVault Inc.	T-GMSRAS2-19L	Sierra Pickup Std 2 Dwr	\$3,745.00	\$3,207.30
336320	TruckVault Inc.	T-GMSRAS2-19S	Sierra Pickup Std 2 Dwr	\$3,545.00	\$3,036.02



336320	TruckVault Inc.	T-GMSRAS2-19S-PC	Sierra Pickup Std 2 Dwr	\$3,345.00	\$2,864.74
336320	TruckVault Inc.	T-GMSRAS2-19S-PC-CB	Sierra Pickup Std 2 Dwr	\$3,125.00	\$2,676.32
336320	TruckVault Inc.	T-GMSRAS2-19S-PC-CB-PW	Sierra Pickup Std 2 Dwr5' 8" Bed, Crew Cab, AW (New)	\$4,145.00	\$3,549.87
336320	TruckVault Inc.	T-GMSRAS2-19S-PC-PW	Sierra Pickup Std 2 Dwr	\$4,145.00	\$3,549.87
336320	TruckVault Inc.	T-GMSRAS2-19S-PL	Sierra Pickup Std 2 Dwr	\$3,545.00	\$3,036.02
336320	TruckVault Inc.	T-GMSRAS2-19S-PW	Sierra Pickup Std 2 Dwr	\$4,445.00	\$3,806.80
336320	TruckVault Inc.	T-GMSRAS2-20L-P5-PW	Sierra 2500/3500 Pickup Std 2 Dwr8' Long Bed, A-Wthr	\$4,745.00	\$4,063.73
336320	TruckVault Inc.	T-GMSRAS2-20L-PL-P5	Sierra Pickup Std 2 Dwr	\$3,645.00	\$3,121.66
336320	TruckVault Inc.	T-GMSRAS2-20S-P5	Sierra Pickup Std 2 Dwr6' 8" Bed	\$3,545.00	\$3,036.02
336320	TruckVault Inc.	T-GMSRAS2-20S-P5-CB-PW	Sierra 2500/3500 Std Dwr6' 8" SB Carbon Body; All-Weather	\$4,445.00	\$3,806.80
336320	TruckVault Inc.	T-GMSRAS2-20S-P5-PL	Sierra Pickup Std 2 Dwr6' 8" Bed	\$3,545.00	\$3,036.02
336320	TruckVault Inc.	T-GMSRAS2-20S-P5-PL-PW	Sierra 2500/3500 Std Dwr6' 8" Short Bed; All-Weather	\$4,445.00	\$3,806.80
336320	TruckVault Inc.	T-GMSRAS2-20S-P5-PW	Sierra 2500/3500 Std Dwr6' 8" Short Bed; All-Weather	\$4,445.00	\$3,806.80
336320	TruckVault Inc.	T-GMSRAS3-07L-P5-C2-PW-ZC9712	Sierra PU CUST Std 3 DwrSierra, LB, A-Wthr, Gooseneck; C9721	\$5,245.00	\$4,491.94
336320	TruckVault Inc.	T-GMSRAS3-19S-C2-PW-Z1	Sierra Pickup Std 3 Dwr	\$4,945.00	\$4,235.01
336320	TruckVault Inc.	T-GMSRAS3-19S-C2-PW-ZC9774	Sierra Pickup Std 3 Dwr	\$4,945.00	\$4,235.01
336320	TruckVault Inc.	T-GMSRAS3-20L-P5-PW-ZC10780	Sierra 2500/3500 Pickup Std Gooseneck	\$5,245.00	\$4,491.94
336320	TruckVault Inc.	T-GMSRAS3-20L-P5-PW-ZC11689	Sierra 2500/3500 Pickup Std Gooseneck	\$5,245.00	\$4,491.94
336320	TruckVault Inc.	T-GMSRAS3-20S-P5-PW-ZC10958	Sierra 2500/3500 Pickup Std GooseneckShort Bed, A-Wthr C10958	\$4,945.00	\$4,235.01
336320	TruckVault Inc.	T-GMSRAS3-20S-P5-PW-ZC11195	Sierra 2500/3500 Pickup Std GooseneckShort Bed, A-Wthr Tailgate Handle	\$5,375.00	\$4,603.27
336320	TruckVault Inc.	T-GMSRAS0-04S-PC	Sierra Pickup Std OS Dwr	\$3,045.00	\$2,607.81
336320	TruckVault Inc.	T-GMSRAS0-04S-PC-PW	Sierra Pickup Std OS Dwr	\$4,145.00	\$3,549.87
336320	TruckVault Inc.	T-GMSRAS0-07L	Sierra Pickup Std Offset Dwr	\$3,445.00	\$2,950.38
336320	TruckVault Inc.	T-GMSRAS0-07L-PW	Sierra Pickup Std Offset DwrLong Bed, All-Wthr	\$4,745.00	\$4,063.73
336320	TruckVault Inc.	T-GMSRAS0-07S	Sierra Pickup Std OS Dwr	\$3,245.00	\$2,779.09
336320	TruckVault Inc.	T-GMSRAS0-07S-PC	Sierra Pickup Std OS Dwr	\$3,045.00	\$2,607.81
336320	TruckVault Inc.	T-GMSRAS0-07S-PC-PW	Sierra Pickup Std OS Dwr	\$4,145.00	\$3,549.87
336320	TruckVault Inc.	T-GMSRAS0-07S-PW	Sierra Pickup Std OS Dwr	\$4,445.00	\$3,806.80
336320	TruckVault Inc.	T-GMSRAS0-15L-PL-PW	Sierra Pickup Std Offset Dwr	\$4,745.00	\$4,063.73
336320	TruckVault Inc.	T-GMSRAS0-15S-PC-PL	Sierra Pickup Std OS Dwr	\$3,045.00	\$2,607.81
336320	TruckVault Inc.	T-GMSRAS0-15S-PC-PL-PW	Sierra Pickup Std OS Dwr	\$4,145.00	\$3,549.87
336320	TruckVault Inc.	T-GMSRAS0-15S-PL	Sierra Pickup Std OS Dwr	\$3,245.00	\$2,779.09
336320	TruckVault Inc.	T-GMSRAS0-15S-PL-PW	Sierra Pickup Std OS Dwr	\$4,445.00	\$3,806.80
336320	TruckVault Inc.	T-GMSRAS0-19L-PL-PW	Sierra Pickup Std Offset Dwr	\$4,745.00	\$4,063.73
336320	TruckVault Inc.	T-GMSRAS0-19L-PW	Sierra Pickup Std Offset Dwr	\$4,745.00	\$4,063.73
336320	TruckVault Inc.	T-GMSRAS0-19S-PC	Sierra Pickup Std OS Dwr5' 8" Bed, Crew Cab	\$3,045.00	\$2,607.81
336320	TruckVault Inc.	T-GMSRAS0-19S-PC-PL	Sierra Pickup Std OS Dwr5' 8" Bed, Crew Cab; Bed Spray	\$3,045.00	\$2,607.81
336320	TruckVault Inc.	T-GMSRAS0-19S-PC-PW	Sierra Pickup Std 2 Dwr Offset5' 8" Bed, Crew Cab, AW (New)	\$4,145.00	\$3,549.87
336320	TruckVault Inc.	T-GMSRAS0-19S-PW	Sierra Pickup Std 2 Dwr Offset	\$4,445.00	\$3,806.80
336320	TruckVault Inc.	T-GMSRAS0-20S-P5-PL	Sierra Pickup Std 2 Dwr Offset6' 8" Bed	\$3,245.00	\$2,779.09
336320	TruckVault Inc.	T-GMSRAS0-20S-P5-PL-PW	Sierra 2500/3500 Std Dwr Offset6' 8" Short Bed; All-Weather	\$4,445.00	\$3,806.80
336320	TruckVault Inc.	T-GMSRAU1-07S-HP	Sierra Utility 1 Dwr Half Width	\$2,435.00	\$2,085.39
336320	TruckVault Inc.	T-GMSRAU1-15S-PL-HD-PW	Sierra Utility 1 Dwr Half Width	\$2,945.00	\$2,522.17
336320	TruckVault Inc.	T-GMSRAU1-19S-HP-PW	Sierra Utility 1 Dwr Half Width	\$2,945.00	\$2,522.17
336320	TruckVault Inc.	T-GMSRAU1-19S-PC-HD-PW	Sierra Utility 1 Dwr Half Width	\$2,645.00	\$2,265.24
336320	TruckVault Inc.	T-GMSRAU1-19S-PC-HP-PW	Sierra Utility 1 Dwr Half Width	\$2,645.00	\$2,265.24
336320	TruckVault Inc.	T-GMSRAU1-20S-P5-CB-HP-PW	Sierra Utility 1 Dwr Half Width6'6", All Wthr; Passanger Side Carbon	\$2,945.00	\$2,522.17
336320	TruckVault Inc.	T-GMSRAU1-20S-P5-HP	Sierra HD Utility 1 Dwr Half Width	\$2,225.00	\$1,905.54
336320	TruckVault Inc.	T-GMSRAU2-04S-PC	Sierra Pickup Utility 2 Dwr	\$3,445.00	\$2,950.38
336320	TruckVault Inc.	T-GMSRAU2-07L-PW	Sierra Pickup Utility 2 Dwr	\$4,845.00	\$4,149.37
336320	TruckVault Inc.	T-GMSRAU2-07S	Sierra Pickup Utility 2 Dwr	\$3,645.00	\$3,121.66
336320	TruckVault Inc.	T-GMSRAU2-07S-PC-PW	Sierra Pickup Utility 2 Dwr5' 8" Bed, Crew Cab, A-Wthr	\$4,245.00	\$3,635.52
336320	TruckVault Inc.	T-GMSRAU2-07S-PW	Sierra Pickup Utility 2 Dwr	\$4,545.00	\$3,892.44
336320	TruckVault Inc.	T-GMSRAU2-07S-RX-PW	Sierra Pickup Utility 2 DwrShort Bed, A-Wthr Retrax	\$4,245.00	\$3,635.52
336320	TruckVault Inc.	T-GMSRAU2-15L-PL-PW	Sierra Pickup Utility 2 Dwr	\$4,845.00	\$4,149.37
336320	TruckVault Inc.	T-GMSRAU2-15S-PC-PL	Sierra Pickup Utility 2 Dwr	\$3,445.00	\$2,950.38
336320	TruckVault Inc.	T-GMSRAU2-15S-PC-PL-PW	Sierra Pickup Utility 2 Dwr5' 8" Bed, CC, Spray Logo, AW	\$4,245.00	\$3,635.52
336320	TruckVault Inc.	T-GMSRAU2-15S-PL	Sierra Pickup Utility 2 Dwr	\$3,645.00	\$3,121.66
336320	TruckVault Inc.	T-GMSRAU2-15S-PL-PW	Sierra Pickup Utility 2 DwrShort Bed, A-Wthr	\$4,545.00	\$3,892.44
336320	TruckVault Inc.	T-GMSRAU2-19L-PW	Sierra Pickup Utility 2 Dwr	\$4,845.00	\$4,149.37
336320	TruckVault Inc.	T-GMSRAU2-19S	Sierra Pickup Utility 2 DwrShort Bed, New Body Style	\$3,645.00	\$3,121.66
336320	TruckVault Inc.	T-GMSRAU2-19S-CB-PW	Sierra Pickup Utility 2 Dwr	\$4,725.00	\$4,046.60
336320	TruckVault Inc.	T-GMSRAU2-19S-PC	Sierra Pickup Utility 2 Dwr	\$3,445.00	\$2,950.38

336320	TruckVault Inc.	T-GMSRAU2-19S-PC-CB	Sierra Pickup Utility 2 Dwr5' 8" Bed, Crew Carbon Bed	\$3,445.00	\$2,950.38
336320	TruckVault Inc.	T-GMSRAU2-19S-PC-CB-PW	Sierra Pickup Utility 2 Dwr	\$4,125.00	\$3,532.75
336320	TruckVault Inc.	T-GMSRAU2-19S-PC-PT	Sierra Pickup Utility 2 Dwr	\$4,140.00	\$3,545.59
336320	TruckVault Inc.	T-GMSRAU2-19S-PC-PW	Sierra Pickup Utility 2 Dwr	\$4,245.00	\$3,635.52
336320	TruckVault Inc.	T-GMSRAU2-19S-PF-PW	Sierra Pickup Utility 2 Dwr	\$4,245.00	\$3,635.52
336320	TruckVault Inc.	T-GMSRAU2-19S-PL-PW	Sierra Pickup Utility 2 Dwr	\$4,545.00	\$3,892.44
336320	TruckVault Inc.	T-GMSRAU2-19S-PW	Sierra Pickup Utility 2 Dwr	\$4,545.00	\$3,892.44
336320	TruckVault Inc.	T-GMSRAU2-20L-P5-PL-PW	Sierra 2500/3500 Pickup Utility 2 Dwr	\$4,845.00	\$4,149.37
336320	TruckVault Inc.	T-GMSRAU2-20S-P5	Sierra Pickup Utility 2 DwrShort Bed, New Body Style	\$3,645.00	\$3,121.66
336320	TruckVault Inc.	T-GMSRAU2-20S-P5-PL	Sierra Pickup Utility 2 Dwr	\$3,645.00	\$3,121.66
336320	TruckVault Inc.	T-GMSRAU2-20S-P5-PL-PW	Sierra 2500/3500 Utility 2 Dwr6' 8" Short Bed; All-Weather	\$4,545.00	\$3,892.44
336320	TruckVault Inc.	T-GMSRAU3-07S-C2-PW-ZC10690	Sierra Pickup Utility 3 DwrGooseneck; All Weather; C10690	\$5,045.00	\$4,320.65
336320	TruckVault Inc.	T-GMSRAU3-20S-P5-PW-ZC10270	Sierra 2500/3500 Pickup Utility GooseneckShort Bed, A-Wthr C10270	\$5,045.00	\$4,320.65
336320	TruckVault Inc.	T-GMSRAU3-20S-P5-PW-ZC11617	Sierra 2500/3500 Pickup Utility Gooseneck	\$4,745.00	\$4,063.73
336320	TruckVault Inc.	T-GMSRAU0-07L	Sierra Pickup Utility Offset Dwr	\$3,545.00	\$3,036.02
336320	TruckVault Inc.	T-GMSRAU0-07L-PW	Sierra Pickup Utility Offset Dwr8' Long Bed, A-Wthr	\$4,845.00	\$4,149.37
336320	TruckVault Inc.	T-GMSRAU0-07S	Sierra Pickup Utility OS Dwr	\$3,345.00	\$2,864.74
336320	TruckVault Inc.	T-GMSRAU0-07S-PW	Sierra Pickup Utility OS Dwr	\$4,545.00	\$3,892.44
336320	TruckVault Inc.	T-GMSRAU0-15S-PC-PL-PW	Sierra Pickup Utility 2 Dwr Offset	\$4,245.00	\$3,635.52
336320	TruckVault Inc.	T-GMSRAU0-15S-PL	Sierra Pickup Utility Offset Dwr	\$3,645.00	\$3,121.66
336320	TruckVault Inc.	T-GMSRAU0-19S-PC	Sierra Pickup Utility 2 Dwr Offset	\$3,145.00	\$2,693.45
336320	TruckVault Inc.	T-GMSRAU0-19S-PC-PW	Sierra Pickup Utility Offset Dwr	\$4,245.00	\$3,635.52
336320	TruckVault Inc.	T-GMSRAU0-19S-PW	Sierra Pickup Utility 2 Dwr Offset	\$4,545.00	\$3,892.44
336320	TruckVault Inc.	T-GMSRAU0-20S-P5-PF-PW	Sierra 2500/3500 Utility OS Dwr	\$4,545.00	\$3,892.44
336320	TruckVault Inc.	T-GMSRAU0-20S-P5-PL-PW	Sierra 2500/3500 Utility OS Dwr6' 8" Short Bed; All-Weather	\$4,545.00	\$3,892.44
336320	TruckVault Inc.	T-GMSRAU0-20S-P5-PW	Sierra 2500/3500 Utility OS Dwr6' 8" Short Bed; All-Weather	\$4,545.00	\$3,892.44
336320	TruckVault Inc.	T-GMSSEM2-99L	Sonoma Pickup Mag 2 Dwr	\$3,545.00	\$3,036.02
336320	TruckVault Inc.	T-GMSSES2-94S	Sonoma Pickup Std 2 Dwr	\$3,345.00	\$2,864.74
336320	TruckVault Inc.	T-GMSSES2-94S-PW	Sonoma Pickup Std 2 Dwr	\$4,345.00	\$3,721.16
336320	TruckVault Inc.	T-GMSSES2-99L	Sonoma Pickup Std 2 Dwr	\$3,345.00	\$2,864.74
336320	TruckVault Inc.	T-GMSSES2-99L-PW	Sonoma Pickup Std 2 Dwr	\$4,345.00	\$3,721.16
336320	TruckVault Inc.	T-GMSUBM1-00S	Suburban Mag 1 Dwr	\$2,095.00	\$1,794.21
336320	TruckVault Inc.	T-GMSUBM1-88S	Suburban Mag 1 Dwr	\$2,095.00	\$1,794.21
336320	TruckVault Inc.	T-GMSUBM1-88S-PT	Suburban Mag 1 Dwr	\$2,790.00	\$2,389.42
336320	TruckVault Inc.	T-GMSUBM2-00F	Suburban Mag 2 Dwr	\$3,245.00	\$2,779.09
336320	TruckVault Inc.	T-GMSUBM2-00F-PT	Suburban Mag 2 Dwr	\$3,940.00	\$3,374.31
336320	TruckVault Inc.	T-GMSUBM2-00M	Suburban Mag 2 Dwr	\$3,045.00	\$2,607.81
336320	TruckVault Inc.	T-GMSUBM2-00S	Suburban Mag 2 Dwr	\$2,645.00	\$2,265.24
336320	TruckVault Inc.	T-GMSUBM2-88M	Suburban Mag 2 Dwr	\$3,045.00	\$2,607.81
336320	TruckVault Inc.	T-GMSUBMO-00F	Suburban Mag OS Dwr	\$3,245.00	\$2,779.09
336320	TruckVault Inc.	T-GMSUBMO-00M	Suburban Mag OS Dwr	\$3,045.00	\$2,607.81
336320	TruckVault Inc.	T-GMSUBMO-00S	Suburban Mag OS Dwr	\$2,645.00	\$2,265.24
336320	TruckVault Inc.	T-GMSUBS1-00S	Suburban Std 1 Dwr	\$1,895.00	\$1,622.92
336320	TruckVault Inc.	T-GMSUBS1-12S	Suburban Std 1 Dwr	\$1,895.00	\$1,622.92
336320	TruckVault Inc.	T-GMSUBS1-88S	Suburban Std 1 Dwr	\$1,895.00	\$1,622.92
336320	TruckVault Inc.	T-GMSUBS2-00F	Suburban Std 2 Dwr	\$3,045.00	\$2,607.81
336320	TruckVault Inc.	T-GMSUBS2-00M	Suburban Std 2 Dwr	\$2,845.00	\$2,436.52
336320	TruckVault Inc.	T-GMSUBS2-00S	Suburban Std 2 Dwr	\$2,445.00	\$2,093.95
336320	TruckVault Inc.	T-GMSUBS2-88F	Suburban Std 2 Dwr	\$2,845.00	\$2,436.52
336320	TruckVault Inc.	T-GMSUBS2-88M	Suburban Std 2 Dwr	\$2,845.00	\$2,436.52
336320	TruckVault Inc.	T-GMSUBS2-88S	Suburban Std 2 Dwr	\$2,445.00	\$2,093.95
336320	TruckVault Inc.	T-GMSUBSO-00F	Suburban Std OS Dwr	\$3,045.00	\$2,607.81
336320	TruckVault Inc.	T-GMSUBSO-00M	Suburban Std OS Dwr	\$2,845.00	\$2,436.52
336320	TruckVault Inc.	T-GMSUBSO-00S	Suburban Std OS Dwr	\$2,445.00	\$2,093.95
336320	TruckVault Inc.	T-GMSUBSO-88F	Suburban Std OS Dwr	\$3,045.00	\$2,607.81
336320	TruckVault Inc.	T-GMSUBSO-88M	Suburban Std OS Dwr	\$2,845.00	\$2,436.52
336320	TruckVault Inc.	T-GMSUBSO-88S	Suburban Std OS Dwr	\$2,445.00	\$2,093.95
336320	TruckVault Inc.	T-GMTERM1-10N	Terrain Mag 1 Dwr	\$2,095.00	\$1,794.21
336320	TruckVault Inc.	T-GMTERM1-10N-HG	Terrain Mag 1 Dwr	\$2,245.00	\$1,922.67
336320	TruckVault Inc.	T-GMTERM1-18N	Terrain Mag 1 Dwr	\$2,095.00	\$1,794.21
336320	TruckVault Inc.	T-GMTERM1-18N-HG	Terrain Mag 1 Dwr	\$1,995.00	\$1,708.56
336320	TruckVault Inc.	T-GMTERM1-18N-HT	Terrain Mag 1 Dwr	\$2,790.00	\$2,389.42
336320	TruckVault Inc.	T-GMTERM2-10N	Terrain Mag 2 Dwr	\$2,645.00	\$2,265.24
336320	TruckVault Inc.	T-GMTERM2-10N-PT	Terrain Mag 2 Dwr	\$3,340.00	\$2,860.45
336320	TruckVault Inc.	T-GMTERMO-10N	Terrain Mag Offset Dwr	\$2,645.00	\$2,265.24
336320	TruckVault Inc.	T-GMTERS1-10N	Terrain Std 1 Dwr	\$1,895.00	\$1,622.92

336320	TruckVault Inc.	T-GMTERS1-10N-HG	Terrain Std 1 Dwr	\$1,965.00	\$1,682.87
336320	TruckVault Inc.	T-GMTERS1-18N	Terrain Std 1 Dwr	\$1,895.00	\$1,622.92
336320	TruckVault Inc.	T-GMTERS1-18N-HG	Terrain Std 1 Dwr	\$1,845.00	\$1,580.10
336320	TruckVault Inc.	T-GMTERS1-18N-HG-ZC8181	Terrain Std 1 Dwr	\$1,455.00	\$1,246.10
336320	TruckVault Inc.	T-GMTERS2-10N	Terrain Std 2 Dwr	\$2,445.00	\$2,093.95
336320	TruckVault Inc.	T-GMTERS2-18N	Terrain Std 2 Dwr	\$2,445.00	\$2,093.95
336320	TruckVault Inc.	T-GMTERSO-18N	Terrain Std OS Dwr	\$2,445.00	\$2,093.95
336320	TruckVault Inc.	T-GMTERU1-18N	Terrain Utility1 Dwr	\$1,995.00	\$1,708.56
336320	TruckVault Inc.	T-GMTERU1-18N-HG	Terrain Utility 1 Dwr	\$1,945.00	\$1,665.74
336320	TruckVault Inc.	T-GMYDEM1-00N	Yukon/Denali Mag 1 Dwr	\$2,295.00	\$1,965.49
336320	TruckVault Inc.	T-GMYDEM1-00N-LN	Yukon/Denali Mag 1 Dwr	\$2,295.00	\$1,965.49
336320	TruckVault Inc.	T-GMYDEM1-00N-PT	Yukon/Denali Mag 1 Dwr	\$2,990.00	\$2,560.71
336320	TruckVault Inc.	T-GMYDEM1-00N-TC	Yukon/Denali Mag 1 Dwr	\$2,295.00	\$1,965.49
336320	TruckVault Inc.	T-GMYDEM1-07N	Yukon/Denali Mag 1 Dwr	\$2,295.00	\$1,965.49
336320	TruckVault Inc.	T-GMYDEM1-07N-PP	Yukon/Denali Mag 1 Dwr	\$2,095.00	\$1,794.21
336320	TruckVault Inc.	T-GMYDEM1-07N-PT	Yukon/Denali Mag 1 Dwr	\$2,990.00	\$2,560.71
336320	TruckVault Inc.	T-GMYDEM1-12N	Yukon/Denali Mag 1 Dwr	\$2,295.00	\$1,965.49
336320	TruckVault Inc.	T-GMYDEM1-12N-PP	Yukon/Denali Mag 1 Dwr	\$2,095.00	\$1,794.21
336320	TruckVault Inc.	T-GMYDEM1-12N-PT	Yukon/Denali Mag 1 Dwr	\$2,990.00	\$2,560.71
336320	TruckVault Inc.	T-GMYDEM1-15N	Yukon/Denali Mag 1 Dwr	\$2,295.00	\$1,965.49
336320	TruckVault Inc.	T-GMYDEM1-15N-CR	Yukon/Denali Mag 1 Dwr	\$2,645.00	\$2,265.24
336320	TruckVault Inc.	T-GMYDEM1-15N-CR-HP	Yukon/Denali Mag 1 Dwr 1/2 Width	\$2,045.00	\$1,751.39
336320	TruckVault Inc.	T-GMYDEM1-15N-ZC7840	Yukon/Denali Mag 1 Dwr	\$1,875.00	\$1,605.79
336320	TruckVault Inc.	T-GMYDEM1-21N-TF-HT	Yukon/Denali Mag 1 Dwr3rd Seat Folded, HD Table	\$2,990.00	\$2,560.71
336320	TruckVault Inc.	T-GMYDEM1-97N	Yukon/Denali Mag 1 Dwr	\$2,295.00	\$1,965.49
336320	TruckVault Inc.	T-GMYDEM2-00N	Yukon/Denali Mag 2 Dwr	\$2,845.00	\$2,436.52
336320	TruckVault Inc.	T-GMYDEM2-00N-PP-LN	Yukon/Denali Mag 2 Dwr	\$2,845.00	\$2,436.52
336320	TruckVault Inc.	T-GMYDEM2-00N-TC-LN	Yukon/Denali Mag 2 Dwr	\$2,845.00	\$2,436.52
336320	TruckVault Inc.	T-GMYDEM2-07N	Yukon/Denali Mag 2 Dwr	\$2,845.00	\$2,436.52
336320	TruckVault Inc.	T-GMYDEM2-07N-PW-ZC11060	Yukon/Denali Mag 2 DwrC11060	\$3,905.00	\$3,344.33
336320	TruckVault Inc.	T-GMYDEM2-12N	Yukon/Denali Mag 2 Dwr	\$2,845.00	\$2,436.52
336320	TruckVault Inc.	T-GMYDEM2-12N-PP	Yukon/Denali Mag 2 Dwr	\$2,645.00	\$2,265.24
336320	TruckVault Inc.	T-GMYDEM2-15N	Yukon/Denali Mag 2 Dwr	\$2,845.00	\$2,436.52
336320	TruckVault Inc.	T-GMYDEM2-15N-CR	Yukon/Denali Mag 2 Dwr	\$2,995.00	\$2,564.99
336320	TruckVault Inc.	T-GMYDEM2-97N	Yukon/Denali Mag 2 Dwr	\$2,845.00	\$2,436.52
336320	TruckVault Inc.	T-GMYDEMO-00N	Yukon/Denali Mag OS Dwr	\$2,845.00	\$2,436.52
336320	TruckVault Inc.	T-GMYDEMO-07N	Yukon/Denali Mag OS Dwr	\$2,845.00	\$2,436.52
336320	TruckVault Inc.	T-GMYDEMO-12N	Yukon/Denali Mag OS Dwr	\$2,845.00	\$2,436.52
336320	TruckVault Inc.	T-GMYDEMO-12N-HT	Yukon/Denali Mag OS Dwr	\$3,540.00	\$3,031.74
336320	TruckVault Inc.	T-GMYDEMO-15N	Yukon/Denali Mag OS Dwr	\$2,845.00	\$2,436.52
336320	TruckVault Inc.	T-GMYDEMO-15N-CR	Yukon/Denali Mag OS Dwr	\$3,195.00	\$2,736.27
336320	TruckVault Inc.	T-GMYDEMO-15N-HT	Yukon/Denali Mag OS Dwr	\$3,540.00	\$3,031.74
336320	TruckVault Inc.	T-GMYDEMO-92N	Yukon/Denali Mag OS Dwr	\$2,845.00	\$2,436.52
336320	TruckVault Inc.	T-GMYDEMO-92N-PP	Yukon/Denali Mag OS Dwr	\$2,845.00	\$2,436.52
336320	TruckVault Inc.	T-GMYDEMT-92N	Yukon/Denali Mag T Dwr	\$2,295.00	\$1,965.49
336320	TruckVault Inc.	T-GMYDEMT-92N-BT	Yukon/Denali Mag T Dwr	\$2,295.00	\$1,965.49
336320	TruckVault Inc.	T-GMYDEMT-97N	Yukon/Denali Mag T Dwr	\$2,295.00	\$1,965.49
336320	TruckVault Inc.	T-GMYDEN0-15N-C2-Z1	Yukon/Denali Custom	\$715.00	\$612.34
336320	TruckVault Inc.	T-GMYDEN0-15S-Z1	Yukon/Denali CUST Box	\$1,115.00	\$954.91
336320	TruckVault Inc.	T-GMYDEN1-15N-HT-TT-ZC11586D	Yukon/Denali Custom 1 Drawer	\$3,415.00	\$2,924.69
336320	TruckVault Inc.	T-GMYDEN1-15N-Z1	Yukon/Denali CUST 1 Dwr	\$1,645.00	\$1,408.82
336320	TruckVault Inc.	T-GMYDEN1-15N-ZC8077	Yukon/Denali Cust 1 Dwr	\$1,555.00	\$1,331.74
336320	TruckVault Inc.	T-GMYDEN2-07N-Z2	Yukon/Denali CUSTOM 2 Dwr	\$2,205.00	\$1,888.41
336320	TruckVault Inc.	T-GMYDES1-00N	Yukon/Denali Std 1 Dwr	\$2,095.00	\$1,794.21
336320	TruckVault Inc.	T-GMYDES1-00N-PP	Yukon/Denali Std 1 Dwr	\$2,095.00	\$1,794.21
336320	TruckVault Inc.	T-GMYDES1-00N-PT	Yukon/Denali Std 1 Dwr	\$2,790.00	\$2,389.42
336320	TruckVault Inc.	T-GMYDES1-00N-TC	Yukon/Denali Std 1 Dwr	\$2,095.00	\$1,794.21
336320	TruckVault Inc.	T-GMYDES1-07N	Yukon/Denali Std 1 Dwr	\$2,095.00	\$1,794.21
336320	TruckVault Inc.	T-GMYDES1-07N-PT	Yukon/Denali Std 1 Dwr	\$2,790.00	\$2,389.42
336320	TruckVault Inc.	T-GMYDES1-12N	Yukon/Denali Std 1 Dwr	\$2,095.00	\$1,794.21
336320	TruckVault Inc.	T-GMYDES1-12N-PT	Yukon/Denali Std 1 Dwr	\$2,790.00	\$2,389.42
336320	TruckVault Inc.	T-GMYDES1-15N	Yukon/Denali Std 1 Dwr	\$2,095.00	\$1,794.21
336320	TruckVault Inc.	T-GMYDES1-15N-CR	Yukon/Denali Std 1 Dwr	\$2,445.00	\$2,093.95
336320	TruckVault Inc.	T-GMYDES1-21N-TF	Yukon/Denali Std 1 Dwr	\$2,095.00	\$1,794.21
336320	TruckVault Inc.	T-GMYDES1-92N-D2	Yukon/Denali Std 1 Dwr	\$2,795.00	\$2,393.70
336320	TruckVault Inc.	T-GMYDES1-97N	Yukon/Denali Std 1 Dwr	\$2,095.00	\$1,794.21

336320	TruckVault Inc.	T-GMYDES2-00N	Yukon/Denali Std 2 Dwr	\$2,645.00	\$2,265.24
336320	TruckVault Inc.	T-GMYDES2-07N	Yukon/Denali Std 2 Dwr	\$2,645.00	\$2,265.24
336320	TruckVault Inc.	T-GMYDES2-07N-PP	Yukon/Denali Std 2 Dwr	\$2,645.00	\$2,265.24
336320	TruckVault Inc.	T-GMYDES2-12N	Yukon/Denali Std 2 Dwr	\$2,645.00	\$2,265.24
336320	TruckVault Inc.	T-GMYDES2-15N	Yukon/Denali Std 2 Dwr	\$2,645.00	\$2,265.24
336320	TruckVault Inc.	T-GMYDES2-15N-CR	Yukon/Denali Std 2 Dwr	\$2,995.00	\$2,564.99
336320	TruckVault Inc.	T-GMYDES2-15N-FP	Yukon Denali Std 2 Dwr	\$2,645.00	\$2,265.24
336320	TruckVault Inc.	T-GMYDES2-21N-TF	Yukon/Denali Std 2 Dwr3rd Seat Folded	\$2,645.00	\$2,265.24
336320	TruckVault Inc.	T-GMYDES2-92N	Yukon/Denali Std 2 Dwr	\$2,645.00	\$2,265.24
336320	TruckVault Inc.	T-GMYDES2-97N	Yukon/Denali Std 2 Dwr	\$2,645.00	\$2,265.24
336320	TruckVault Inc.	T-GMYDESO-00N	Yukon/Denali Std OS Dwr	\$2,645.00	\$2,265.24
336320	TruckVault Inc.	T-GMYDESO-00N-LN	Yukon/Denali Std OS Dwr	\$2,645.00	\$2,265.24
336320	TruckVault Inc.	T-GMYDESO-00N-PT	Yukon/Denali Std OS Dwr	\$3,340.00	\$2,860.45
336320	TruckVault Inc.	T-GMYDESO-00N-Z1	Yukon/Denali Std 1 Dwr	\$2,525.00	\$2,162.47
336320	TruckVault Inc.	T-GMYDESO-07N	Yukon/Denali Std OS Dwr	\$2,645.00	\$2,265.24
336320	TruckVault Inc.	T-GMYDESO-12N	Yukon/Denali Std OS Dwr	\$2,645.00	\$2,265.24
336320	TruckVault Inc.	T-GMYDESO-15N	Yukon/Denali Std OS Dwr	\$2,645.00	\$2,265.24
336320	TruckVault Inc.	T-GMYDESO-15N-CR	Yukon/Denali Std OS Dwr	\$2,995.00	\$2,564.99
336320	TruckVault Inc.	T-GMYDESO-92N	Yukon/Denali Std OS Dwr	\$2,645.00	\$2,265.24
336320	TruckVault Inc.	T-GMYDESO-97N	Yukon/Denali Std OS Dwr	\$2,645.00	\$2,265.24
336320	TruckVault Inc.	T-GMYDEU1-12N	Yukon/Denali Std 1 Dwr	\$2,195.00	\$1,879.85
336320	TruckVault Inc.	T-GMYDEU2-07N-HT	Yukon/Denali Utility 2 Dwr	\$3,320.00	\$2,843.32
336320	TruckVault Inc.	T-GMYDEU2-15N-CR	Yukon/Denali Utility 2 Dwr3rd Row Folded; Tray Removed	\$3,095.00	\$2,650.63
336320	TruckVault Inc.	T-GMYDEU2-92N	Yukon/Denali Utility 2 Dwr	\$2,745.00	\$2,350.88
336320	TruckVault Inc.	T-GMYDEUO-21N-TF	Yukon/Denali Utility OS Dwr	\$2,745.00	\$2,350.88
336320	TruckVault Inc.	T-GMYDM1-15N-HD	Yukon/Denali Mag 1 Dwr 1/2 width Drivers	\$1,825.00	\$1,562.97
336320	TruckVault Inc.	T-GMYXLM1-00S	Yukon XL Mag 1 Dwr	\$2,095.00	\$1,794.21
336320	TruckVault Inc.	T-GMYXLM1-07M	Yukon XL Mag 1 Dwr	\$2,495.00	\$2,136.78
336320	TruckVault Inc.	T-GMYXLM1-07S	Yukon XL Mag 1 Dwr	\$2,095.00	\$1,794.21
336320	TruckVault Inc.	T-GMYXLM1-07S-HT	Yukon XL Mag 1 Dwr	\$2,790.00	\$2,389.42
336320	TruckVault Inc.	T-GMYXLM1-12M	Yukon XL Mag 1 Dwr	\$2,495.00	\$2,136.78
336320	TruckVault Inc.	T-GMYXLM1-12S	Yukon XL Mag 1 Dwr	\$2,095.00	\$1,794.21
336320	TruckVault Inc.	T-GMYXLM1-12S-PT	Yukon XL Mag 1 Dwr	\$2,790.00	\$2,389.42
336320	TruckVault Inc.	T-GMYXLM1-15M	Yukon Mag 1 Dwr	\$2,495.00	\$2,136.78
336320	TruckVault Inc.	T-GMYXLM1-15M-CR	Yukon Mag 1 Dwr	\$2,445.00	\$2,093.95
336320	TruckVault Inc.	T-GMYXLM1-15S	Yukon XL Mag 1 Dwr	\$2,095.00	\$1,794.21
336320	TruckVault Inc.	T-GMYXLM1-15S-HT	Yukon XL Mag 1 Dwr	\$2,790.00	\$2,389.42
336320	TruckVault Inc.	T-GMYXLM1-15S-PT	Yukon XL Mag 1 Dwr	\$2,790.00	\$2,389.42
336320	TruckVault Inc.	T-GMYXLM1-21S	Yukon XL Mag 1 DwrS-Size, 3rd Seat Upright	\$2,095.00	\$1,794.21
336320	TruckVault Inc.	T-GMYXLM1-88S	Yukon XL Mag 1 Dwr	\$2,095.00	\$1,794.21
336320	TruckVault Inc.	T-GMYXLM2-00F	Yukon XL Mag 2 Dwr	\$3,245.00	\$2,779.09
336320	TruckVault Inc.	T-GMYXLM2-00F-LN	Yukon XL Mag 2 Dwr	\$3,245.00	\$2,779.09
336320	TruckVault Inc.	T-GMYXLM2-00F-PP	Yukon XL Mag 2 Dwr	\$3,045.00	\$2,607.81
336320	TruckVault Inc.	T-GMYXLM2-00F-PP-LN	Yukon XL Mag 2 Dwr	\$3,045.00	\$2,607.81
336320	TruckVault Inc.	T-GMYXLM2-00F-PT	Yukon XL Mag 2 Dwr	\$3,940.00	\$3,374.31
336320	TruckVault Inc.	T-GMYXLM2-00F-TC	Yukon XL Mag 2 Dwr	\$3,045.00	\$2,607.81
336320	TruckVault Inc.	T-GMYXLM2-00F-TC-LN	Yukon XL Mag 2 Dwr	\$3,045.00	\$2,607.81
336320	TruckVault Inc.	T-GMYXLM2-00M	Yukon XL Mag 2 Dwr	\$3,045.00	\$2,607.81
336320	TruckVault Inc.	T-GMYXLM2-00M-LN	Yukon XL Mag 2 Dwr	\$3,045.00	\$2,607.81
336320	TruckVault Inc.	T-GMYXLM2-00M-PT	Yukon XL Mag 2 Dwr	\$3,740.00	\$3,203.02
336320	TruckVault Inc.	T-GMYXLM2-00S	Yukon XL Mag 2 Dwr	\$2,645.00	\$2,265.24
336320	TruckVault Inc.	T-GMYXLM2-07F	Yukon XL Mag 2 Dwr	\$3,245.00	\$2,779.09
336320	TruckVault Inc.	T-GMYXLM2-07F-PT	Yukon XL Mag 2 Dwr	\$3,740.00	\$3,203.02
336320	TruckVault Inc.	T-GMYXLM2-07M	Yukon XL Mag 2 Dwr	\$3,045.00	\$2,607.81
336320	TruckVault Inc.	T-GMYXLM2-07S	Yukon XL Mag 2 Dwr	\$2,645.00	\$2,265.24
336320	TruckVault Inc.	T-GMYXLM2-12F	Yukon XL Mag 2 Dwr	\$3,245.00	\$2,779.09
336320	TruckVault Inc.	T-GMYXLM2-12F-PT	Yukon XL Mag 2 Dwr	\$3,740.00	\$3,203.02
336320	TruckVault Inc.	T-GMYXLM2-12M	Yukon XL Mag 2 Dwr	\$3,045.00	\$2,607.81
336320	TruckVault Inc.	T-GMYXLM2-12M-Z1	Yukon XL Mag 2 Dwr	\$2,525.00	\$2,162.47
336320	TruckVault Inc.	T-GMYXLM2-12S	Yukon XL Mag 2 Dwr	\$2,645.00	\$2,265.24
336320	TruckVault Inc.	T-GMYXLM2-15F	Yukon XL Mag 2 Dwr	\$3,245.00	\$2,779.09
336320	TruckVault Inc.	T-GMYXLM2-15F-CR	Yukon XL Mag 2 Dwr	\$3,395.00	\$2,907.56
336320	TruckVault Inc.	T-GMYXLM2-15M	Yukon XL Mag 2 Dwr	\$3,045.00	\$2,607.81
336320	TruckVault Inc.	T-GMYXLM2-15M-CR	Yukon XL Mag 2 Dwr	\$3,395.00	\$2,907.56
336320	TruckVault Inc.	T-GMYXLM2-15S	Yukon XL Mag 2 Dwr	\$2,645.00	\$2,265.24
336320	TruckVault Inc.	T-GMYXLM2-21F-TF-HT	Yukon XL Mag 2 Dwr	\$3,740.00	\$3,203.02

336320	TruckVault Inc.	T-GMYXLM2-88M	Yukon XL Mag 2 Dwr	\$3,045.00	\$2,607.81
336320	TruckVault Inc.	T-GMYXLMO-00F	Yukon XL Mag OS Dwr	\$3,245.00	\$2,779.09
336320	TruckVault Inc.	T-GMYXLMO-00F-LN	Yukon XL Mag OS Dwr	\$3,245.00	\$2,779.09
336320	TruckVault Inc.	T-GMYXLMO-00F-PP	Yukon XL Mag OS Dwr	\$3,045.00	\$2,607.81
336320	TruckVault Inc.	T-GMYXLMO-00F-PP-LN	Yukon XL Mag OS Dwr	\$3,045.00	\$2,607.81
336320	TruckVault Inc.	T-GMYXLMO-00M	Yukon XL Mag OS Dwr	\$3,045.00	\$2,607.81
336320	TruckVault Inc.	T-GMYXLMO-00M-LN	Yukon XL Mag OS Dwr	\$3,045.00	\$2,607.81
336320	TruckVault Inc.	T-GMYXLMO-00M-PT	Yukon XL Mag Offset	\$3,740.00	\$3,203.02
336320	TruckVault Inc.	T-GMYXLMO-00S	Yukon XL Mag OS Dwr	\$2,645.00	\$2,265.24
336320	TruckVault Inc.	T-GMYXLMO-07F	Yukon XL Mag OS Dwr	\$3,245.00	\$2,779.09
336320	TruckVault Inc.	T-GMYXLMO-07F-PT	Yukon XL Mag OS Dwr	\$3,740.00	\$3,203.02
336320	TruckVault Inc.	T-GMYXLMO-07M	Yukon XL Mag OS Dwr	\$3,045.00	\$2,607.81
336320	TruckVault Inc.	T-GMYXLMO-07S	Yukon XL Mag OS Dwr	\$2,645.00	\$2,265.24
336320	TruckVault Inc.	T-GMYXLMO-12F	Yukon XL Mag OS Dwr	\$3,245.00	\$2,779.09
336320	TruckVault Inc.	T-GMYXLMO-12F-PT	Yukon XL Mag OS Dwr	\$3,740.00	\$3,203.02
336320	TruckVault Inc.	T-GMYXLMO-12M	Yukon XL Mag OS Dwr	\$3,045.00	\$2,607.81
336320	TruckVault Inc.	T-GMYXLMO-12S	Yukon XL Mag OS Dwr	\$2,645.00	\$2,265.24
336320	TruckVault Inc.	T-GMYXLMO-15F	Yukon XL Mag OS Dwr	\$3,245.00	\$2,779.09
336320	TruckVault Inc.	T-GMYXLMO-15F-HT	Yukon XL Mag OS Dwr	\$3,740.00	\$3,203.02
336320	TruckVault Inc.	T-GMYXLMO-15M	Yukon XL Mag Offset DwrM-Size, Tray/3rd Removed	\$2,985.00	\$2,556.42
336320	TruckVault Inc.	T-GMYXLN1-15F-Z1	C4868	\$1,865.00	\$1,597.23
336320	TruckVault Inc.	T-GMYXLN1-15S-HT	Yukon XL Mag 1 DwrC8426	\$2,795.00	\$2,393.70
336320	TruckVault Inc.	T-GMYXLN1-15S-HT-ZC8426	Yukon XL Mag 1 DwrC8426	\$2,925.00	\$2,505.04
336320	TruckVault Inc.	T-GMYXLS1-00S	Yukon XL Std 1 Dwr	\$1,895.00	\$1,622.92
336320	TruckVault Inc.	T-GMYXLS1-00S-PT	Yukon XL Std 1 Dwr	\$2,590.00	\$2,218.14
336320	TruckVault Inc.	T-GMYXLS1-07S	Yukon XL Std 1 Dwr	\$1,895.00	\$1,622.92
336320	TruckVault Inc.	T-GMYXLS1-07S-PT	Yukon XL Std 1 Dwr	\$2,590.00	\$2,218.14
336320	TruckVault Inc.	T-GMYXLS1-12M	Yukon XL Std 1 Dwr	\$2,295.00	\$1,965.49
336320	TruckVault Inc.	T-GMYXLS1-12S	Yukon XL Std 1 Dwr	\$1,895.00	\$1,622.92
336320	TruckVault Inc.	T-GMYXLS1-12S-PT	Yukon XL Std 1 Dwr	\$2,590.00	\$2,218.14
336320	TruckVault Inc.	T-GMYXLS1-15M	Yukon XL Std 1 Dwr	\$2,295.00	\$1,965.49
336320	TruckVault Inc.	T-GMYXLS1-15M-CR	Yukon XL Std 1 Dwr	\$2,645.00	\$2,265.24
336320	TruckVault Inc.	T-GMYXLS1-15M-PT	Yukon XL Std 1 Dwr, Pullout Table	\$2,720.00	\$2,329.47
336320	TruckVault Inc.	T-GMYXLS1-15M-Z1	Yukon XL Std 1 Dwr	\$1,975.00	\$1,691.44
336320	TruckVault Inc.	T-GMYXLS1-15S	Yukon XL Std 1 Dwr	\$1,895.00	\$1,622.92
336320	TruckVault Inc.	T-GMYXLS1-15S-HT	Yukon XL Std 1 Dwr	\$2,590.00	\$2,218.14
336320	TruckVault Inc.	T-GMYXLS1-15S-ZC9464	Yukon XL Std 1 Dwr	\$2,345.00	\$2,008.31
336320	TruckVault Inc.	T-GMYXLS1-21S	Yukon XL Std 1 DwrS-Size; 3rd Seat Upright	\$1,895.00	\$1,622.92
336320	TruckVault Inc.	T-GMYXLS1-88S	Yukon XL Std 1 Dwr	\$1,895.00	\$1,622.92
336320	TruckVault Inc.	T-GMYXLS2-00F	Yukon XL Std 2 Dwr	\$3,045.00	\$2,607.81
336320	TruckVault Inc.	T-GMYXLS2-00F-LN	Yukon XL Std 2 Dwr	\$3,045.00	\$2,607.81
336320	TruckVault Inc.	T-GMYXLS2-00F-PT	Yukon XL Std 2 Dwr	\$3,740.00	\$3,203.02
336320	TruckVault Inc.	T-GMYXLS2-00F-TC	Yukon XL Std 2 Dwr	\$2,845.00	\$2,436.52
336320	TruckVault Inc.	T-GMYXLS2-00M	Yukon XL Std 2 Dwr	\$2,845.00	\$2,436.52
336320	TruckVault Inc.	T-GMYXLS2-00M-LN	Yukon XL Std 2 Dwr	\$2,845.00	\$2,436.52
336320	TruckVault Inc.	T-GMYXLS2-00S	Yukon XL Std 2 Dwr	\$2,445.00	\$2,093.95
336320	TruckVault Inc.	T-GMYXLS2-07F	Yukon XL Std 2 Dwr	\$3,045.00	\$2,607.81
336320	TruckVault Inc.	T-GMYXLS2-07F-PT	Yukon XL Std 2 Dwr	\$3,740.00	\$3,203.02
336320	TruckVault Inc.	T-GMYXLS2-07M	Yukon XL Std 2 Dwr	\$2,845.00	\$2,436.52
336320	TruckVault Inc.	T-GMYXLS2-07S	Yukon XL Std 2 Dwr	\$2,445.00	\$2,093.95
336320	TruckVault Inc.	T-GMYXLS2-12F	Yukon XL Std 2 Dwr	\$3,045.00	\$2,607.81
336320	TruckVault Inc.	T-GMYXLS2-12F-PT	Yukon XL Std 2 Dwr	\$3,740.00	\$3,203.02
336320	TruckVault Inc.	T-GMYXLS2-12M	Yukon XL Std 2 Dwr	\$2,845.00	\$2,436.52
336320	TruckVault Inc.	T-GMYXLS2-12S	Yukon XL Std 2 Dwr	\$2,445.00	\$2,093.95
336320	TruckVault Inc.	T-GMYXLS2-12S-PT	Yukon XL Std 2 Dwr	\$3,140.00	\$2,689.17
336320	TruckVault Inc.	T-GMYXLS2-15F	Yukon XL Std 2 Dwr	\$3,045.00	\$2,607.81
336320	TruckVault Inc.	T-GMYXLS2-15F-CR	Yukon XL Std 2 Dwr	\$3,195.00	\$2,736.27
336320	TruckVault Inc.	T-GMYXLS2-15F-PP	Yukon XL Std 2 Dwr	\$2,845.00	\$2,436.52
336320	TruckVault Inc.	T-GMYXLS2-15F-PT	Yukon XL Std 2 Dwr	\$3,740.00	\$3,203.02
336320	TruckVault Inc.	T-GMYXLS2-15M	Yukon XL Std 2 Dwr	\$2,765.00	\$2,368.01
336320	TruckVault Inc.	T-GMYXLS2-15M-CR	Yukon XL Std 2 Dwr	\$3,195.00	\$2,736.27
336320	TruckVault Inc.	T-GMYXLS2-15M-PT	Yukon XL Std 2 Dwr	\$3,465.00	\$2,967.51
336320	TruckVault Inc.	T-GMYXLS2-15S	Yukon XL Std 2 Dwr	\$2,445.00	\$2,093.95
336320	TruckVault Inc.	T-GMYXLS2-15S-PT	Yukon XL Std 2 Dwr	\$3,140.00	\$2,689.17
336320	TruckVault Inc.	T-GMYXLS2-21F-TF	Yukon XL Std 2 DwrF-Size, 3rd Seat Folded	\$2,985.00	\$2,556.42
336320	TruckVault Inc.	T-GMYXLS2-21F-TR	Yukon XL Std 2 Dwr	\$2,845.00	\$2,436.52

336320	TruckVault Inc.	T-GMYXLS2-88M	Yukon XL Std 2 Dwr	\$2,845.00	\$2,436.52
336320	TruckVault Inc.	T-GMYXLSO-00F	Yukon XL Std OS Dwr	\$3,045.00	\$2,607.81
336320	TruckVault Inc.	T-GMYXLSO-00F-LN	Yukon XL Std OS Dwr	\$3,045.00	\$2,607.81
336320	TruckVault Inc.	T-GMYXLSO-00F-PT	Yukon XL Std OS Dwr	\$3,740.00	\$3,203.02
336320	TruckVault Inc.	T-GMYXLSO-00F-TC	Yukon XL Std OS Dwr	\$2,845.00	\$2,436.52
336320	TruckVault Inc.	T-GMYXLSO-00M	Yukon XL Std OS Dwr	\$2,845.00	\$2,436.52
336320	TruckVault Inc.	T-GMYXLSO-00M-LN	Yukon XL Std OS Dwr	\$2,845.00	\$2,436.52
336320	TruckVault Inc.	T-GMYXLSO-00M-PT	Yukon XL Std OS Dwr	\$3,540.00	\$3,031.74
336320	TruckVault Inc.	T-GMYXLSO-00S	Yukon XL Std OS Dwr	\$2,445.00	\$2,093.95
336320	TruckVault Inc.	T-GMYXLSO-00S-PT	Yukon XL Std OS Dwr	\$3,140.00	\$2,689.17
336320	TruckVault Inc.	T-GMYXLSO-07F	Yukon XL Std OS Dwr	\$3,045.00	\$2,607.81
336320	TruckVault Inc.	T-GMYXLSO-07F-ORV	Yukon XL Std OS Dwr	\$2,985.00	\$2,556.42
336320	TruckVault Inc.	T-GMYXLSO-07F-PT	Yukon XL Std OS Dwr	\$3,740.00	\$3,203.02
336320	TruckVault Inc.	T-GMYXLSO-07M	Yukon XL Std OS Dwr	\$2,845.00	\$2,436.52
336320	TruckVault Inc.	T-GMYXLSO-07M-PT	Yukon XL Std OS Dwr	\$3,540.00	\$3,031.74
336320	TruckVault Inc.	T-GMYXLSO-07S	Yukon XL Std OS Dwr	\$2,445.00	\$2,093.95
336320	TruckVault Inc.	T-GMYXLSO-12F	Yukon XL Std OS Dwr	\$3,045.00	\$2,607.81
336320	TruckVault Inc.	T-GMYXLSO-12F-PT	Yukon XL Std OS Dwr	\$3,740.00	\$3,203.02
336320	TruckVault Inc.	T-GMYXLSO-12M	Yukon XL Std OS Dwr	\$2,845.00	\$2,436.52
336320	TruckVault Inc.	T-GMYXLSO-12M-PT	Yukon XL Std OS Dwr	\$3,540.00	\$3,031.74
336320	TruckVault Inc.	T-GMYXLSO-12S	Yukon XL Std OS Dwr	\$2,445.00	\$2,093.95
336320	TruckVault Inc.	T-GMYXLSO-15F	Yukon XL Std OS Dwr	\$3,045.00	\$2,607.81
336320	TruckVault Inc.	T-GMYXLSO-15F-CR	Yukon XL Std Offset Dwr	\$3,195.00	\$2,736.27
336320	TruckVault Inc.	T-GMYXLSO-15F-HT	Yukon XL Std OS Dwr	\$3,740.00	\$3,203.02
336320	TruckVault Inc.	T-GMYXLSO-15S	Yukon XL Std OS Dwr	\$2,445.00	\$2,093.95
336320	TruckVault Inc.	T-GMYXLU1-00S	Yukon XL Utility 1 Dwr	\$1,995.00	\$1,708.56
336320	TruckVault Inc.	T-GMYXLU1-07S	Yukon XL Utility 1 Dwr	\$1,995.00	\$1,708.56
336320	TruckVault Inc.	T-GMYXLU1-15M-CR-PT	Yukon XL Utility 1 Dwr	\$3,440.00	\$2,946.10
336320	TruckVault Inc.	T-GMYXLU1-15S	Yukon XL Utility 1 Dwr	\$1,995.00	\$1,708.56
336320	TruckVault Inc.	T-GMYXLU1-15S-HT	Yukon XL Utility 1 Dwr	\$2,690.00	\$2,303.78
336320	TruckVault Inc.	T-GMYXLU1-21S	Yukon XL Utility 1 DwrS-Size, 3rd Seat Upright	\$1,995.00	\$1,708.56
336320	TruckVault Inc.	T-GMYXLU2-15F	Yukon XL Utility 2 Dwr	\$3,095.00	\$2,650.63
336320	TruckVault Inc.	T-GMYXLU2-15F-CR	Yukon XL Utility 2 DwrF-Size, Tray/3rd Folded	\$3,495.00	\$2,993.20
336320	TruckVault Inc.	T-GMYXLU2-15S	Yukon XL Utility 2 Dwr	\$2,545.00	\$2,179.60
336320	TruckVault Inc.	T-GMYXLU2-21F-TF	Yukon XL Utility 2 Dwr	\$2,825.00	\$2,419.40
336320	TruckVault Inc.	T-GMYXLUO-07F	Yukon XL Utility OS DwrF-Size	\$3,095.00	\$2,650.63
336320	TruckVault Inc.	T-GMYXLUO-15F	Yukon XL Utility OS Dwr	\$2,945.00	\$2,522.17
336320	TruckVault Inc.	T-GMYXLUO-15F-HT	Yukon XL Utility OS Dwr	\$3,840.00	\$3,288.66
336320	TruckVault Inc.	T-GMYXLUO-15M-CR	Yukon XL Utility Offset DwrM-Size, Tray Removed, 3rd Fold	\$3,205.00	\$2,744.84
336320	TruckVault Inc.	T-HDCRVM1-02N	Honda CRV Mag 1 Dwr, dimensions: 31L x 38W	\$2,095.00	\$1,794.21
336320	TruckVault Inc.	T-HDCRVM1-07N	Honda CRV Mag 1 Dwr, dimensions: 30.5L x 39W	\$2,095.00	\$1,794.21
336320	TruckVault Inc.	T-HDCRVM1-17N	CRV Mag 1 Dwr	\$2,095.00	\$1,794.21
336320	TruckVault Inc.	T-HDCRVM2-02N	Honda CRV Mag 2 Dwr, dimensions: 0L x 0W	\$2,645.00	\$2,265.24
336320	TruckVault Inc.	T-HDCRVM2-07N	Honda CRV Mag 2 Dwr, dimensions: 30.5L x 39W	\$2,645.00	\$2,265.24
336320	TruckVault Inc.	T-HDCRVM2-17N	CRV Mag 2 Dwr	\$2,645.00	\$2,265.24
336320	TruckVault Inc.	T-HDCRVS1-02N	Honda CRV Std 1 Dwr, dimensions: 32L x 38W	\$1,895.00	\$1,622.92
336320	TruckVault Inc.	T-HDCRVS1-07N	Honda CRV Std 1 Dwr, dimensions: 31.5L x 39W	\$1,895.00	\$1,622.92
336320	TruckVault Inc.	T-HDCRVS1-17N	CRV Std 1 Dwr	\$1,895.00	\$1,622.92
336320	TruckVault Inc.	T-HDCRVS1-95N	CRV Std 1 Dwr	\$1,695.00	\$1,451.64
336320	TruckVault Inc.	T-HDCRVS2-02N	Honda CRV Std 2 Dwr, dimensions: 0L x 0W	\$2,445.00	\$2,093.95
336320	TruckVault Inc.	T-HDCRVS2-07N	Honda CRV Std 2 Dwr, dimensions: 31.5L x 39W	\$2,445.00	\$2,093.95
336320	TruckVault Inc.	T-HDCRVS2-17N	CRV Std 2 Dwr	\$2,445.00	\$2,093.95
336320	TruckVault Inc.	T-HDCRVU1-17N	CRV Utility 1 Dwr	\$1,995.00	\$1,708.56
336320	TruckVault Inc.	T-HDCTRS1-10N	Honda Crosstour Std 1 Dwr, dimensions: 36L x 30W	\$1,895.00	\$1,622.92
336320	TruckVault Inc.	T-HDELMM1-03N	Honda Element Mag 1 Dwr, dimensions: 21L x 41.25W	\$1,895.00	\$1,622.92
336320	TruckVault Inc.	T-HDELMM2-03N	Honda Element Mag 2 Dwr, dimensions: 0L x 0W	\$2,445.00	\$2,093.95
336320	TruckVault Inc.	T-HDELMU1-03N	Element Utility 1 Dwr	\$1,795.00	\$1,537.28
336320	TruckVault Inc.	T-HDFITS1-14N	Fit Std 1 Dwr	\$1,495.00	\$1,280.35
336320	TruckVault Inc.	T-HDHRVS1-18N	HR-V Std 1 Dwr	\$1,895.00	\$1,622.92
336320	TruckVault Inc.	T-HDHRVS2-18N	HR-V Std 2 Dwr	\$1,995.00	\$1,708.56
336320	TruckVault Inc.	T-HDHRVU1-16N	HR-V Utility 1 Dwr	\$1,995.00	\$1,708.56
336320	TruckVault Inc.	T-HDODYM1-05N	Honda Odyssey Mag 1 Dwr, dimensions: 49L x 46W	\$2,435.00	\$2,085.39
336320	TruckVault Inc.	T-HDODYM1-11N	Odyssey Mag 1 Dwr	\$2,435.00	\$2,085.39
336320	TruckVault Inc.	T-HDODYM1-18N	Odyssey Mag 1 Dwr	\$2,435.00	\$2,085.39
336320	TruckVault Inc.	T-HDODYM2-11N	Honda Odyssey Mag 2 Dwr, dimensions: 49L x 46W	\$2,985.00	\$2,556.42
336320	TruckVault Inc.	T-HDODYMO-11N	Honda Odyssey Mag Offset Dwr, dimensions: 49L x 46W	\$2,985.00	\$2,556.42

336320	TruckVault Inc.	T-HDODYN0-11S	Honda Odyssey Flip Lid 1 Dwr, dimensions: 21L x 41W	\$1,195.00	\$1,023.43
336320	TruckVault Inc.	T-HDODYS1-18N	Odyssey Std 1 Dwr	\$2,215.00	\$1,896.98
336320	TruckVault Inc.	T-HDODYS2-05N	Honda Odyssey Std 2 Dwr, dimensions: 52L x 48W	\$2,755.00	\$2,359.45
336320	TruckVault Inc.	T-HDODYS2-11N	Honda Odyssey Std 2 Dwr, dimensions: 51L x 46W	\$2,755.00	\$2,359.45
336320	TruckVault Inc.	T-HDODYS2-18N	Odyssey Std 2 Dwr	\$2,845.00	\$2,436.52
336320	TruckVault Inc.	T-HDODYU1-05N	Odyssey Utility 1 Dwr	\$2,325.00	\$1,991.18
336320	TruckVault Inc.	T-HDODYU1-18S	Odyssey Utility 1 Dwr3rd Row Up-right	\$1,795.00	\$1,537.28
336320	TruckVault Inc.	T-HDPASM1-19S	Passport Mag 1 Dwr	\$2,095.00	\$1,794.21
336320	TruckVault Inc.	T-HDPASS1-19N	Passport Std 1 Dwr	\$1,895.00	\$1,622.92
336320	TruckVault Inc.	T-HDPASS2-19N	Std 2 Dwr	\$2,445.00	\$2,093.95
336320	TruckVault Inc.	T-HDPASUO-19N	Utility 2 Dwr Offset	\$2,545.00	\$2,179.60
336320	TruckVault Inc.	T-HDPILM1-03N	Honda Pilot Mag 1 Dwr, dimensions: 36L x 48W	\$2,295.00	\$1,965.49
336320	TruckVault Inc.	T-HDPILM1-09N	Honda Pilot Mag 1 Dwr, dimensions: 37L x 46W	\$2,295.00	\$1,965.49
336320	TruckVault Inc.	T-HDPILM1-09N-HT	Pilot Mag 1 Dwr3rd Row Seat Folded; Heavy Duty Table	\$2,990.00	\$2,560.71
336320	TruckVault Inc.	T-HDPILM1-16N	Pilot Mag 1 Dwr	\$2,295.00	\$1,965.49
336320	TruckVault Inc.	T-HDPILM2-03N	Honda Pilot Mag 2 Dwr, dimensions: 36L x 48W	\$2,845.00	\$2,436.52
336320	TruckVault Inc.	T-HDPILM2-09N	Pilot Mag 2 Dwr	\$2,845.00	\$2,436.52
336320	TruckVault Inc.	T-HDPILM2-16N	Pilot Mag 2 Dwr	\$2,845.00	\$2,436.52
336320	TruckVault Inc.	T-HDPILS1-03N	Honda Pilot Std 1 Dwr, dimensions: 38L x 48W	\$2,095.00	\$1,794.21
336320	TruckVault Inc.	T-HDPILS1-09N	Honda Pilot Std 1 Dwr, dimensions: 39L x 46W	\$2,095.00	\$1,794.21
336320	TruckVault Inc.	T-HDPILS1-16N	Pilot Std 1 Dwr	\$2,095.00	\$1,794.21
336320	TruckVault Inc.	T-HDPILS2-03N	Honda Pilot Std 2 Dwr, dimensions: 38L x 48W	\$2,645.00	\$2,265.24
336320	TruckVault Inc.	T-HDPILS2-09N	Pilot Std 2 Dwr	\$2,645.00	\$2,265.24
336320	TruckVault Inc.	T-HDPILS2-16N	Pilot Std 2 Dwr	\$2,645.00	\$2,265.24
336320	TruckVault Inc.	T-HDPILSO-03N	Pilot Std 2 Dwr Offset	\$2,645.00	\$2,265.24
336320	TruckVault Inc.	T-HDPILU1-09N	Pilot Utility 1 Dwr3rd Row Seat Folded	\$2,195.00	\$1,879.85
336320	TruckVault Inc.	T-HDPILU1-16N	Pilot Utility1 DwrSeat Folded	\$2,195.00	\$1,879.85
336320	TruckVault Inc.	T-HDPILU1-16N-ZC11049	Pilot Utility1 Dwr Shortened for cubby accessSeat Folded	\$2,015.00	\$1,725.69
336320	TruckVault Inc.	T-HDRIDM2-17S-PC	Ridgeline Pickup Mag 2 Drawer	\$3,345.00	\$2,864.74
336320	TruckVault Inc.	T-HDRIDS2-05S-PC-PW	Ridgeline Pickup Std 2 Drawer	\$3,755.00	\$3,215.87
336320	TruckVault Inc.	T-HDRIDS2-06S-PC	Ridgeline Pickup Std 2 Drawer5' S-Crew	\$3,145.00	\$2,693.45
336320	TruckVault Inc.	T-HDRIDS2-17S-PC	Ridgeline Pickup Std 2 Drawer	\$2,985.00	\$2,556.42
336320	TruckVault Inc.	T-HDRIDS2-17S-PC-PW	Ridgeline Pickup Std 2 Drawer	\$3,755.00	\$3,215.87
336320	TruckVault Inc.	T-HDRIDSO-05S-PC-PW	Ridgeline Pickup Std OS Drawer	\$3,755.00	\$3,215.87
336320	TruckVault Inc.	T-HDRIDU2-17S-PC-PW	Ridgeline Pickup Utility 2 Drawer	\$3,865.00	\$3,310.08
336320	TruckVault Inc.	T-HYENTS2-07S	Hyundai Entourage Std 2 Dwr, dimensions: 48L x 46W	\$2,755.00	\$2,359.45
336320	TruckVault Inc.	T-HYKONM1-18N	Kona Mag 1 DrawerTrunkVault	\$1,895.00	\$1,622.92
336320	TruckVault Inc.	T-HYPALM1-20N	Palisade Mag 1 Dwr3rd Row Folded	\$2,295.00	\$1,965.49
336320	TruckVault Inc.	T-HYPALM1-20S	Palisade Mag 1 DwrBehind 3rd Row Seat	\$1,895.00	\$1,622.92
336320	TruckVault Inc.	T-HYPALMO-20N	Palisade Mag 2 Dwr Offset	\$2,845.00	\$2,436.52
336320	TruckVault Inc.	T-HYPALS1-20N	Palisade Std 1 Dwr3rd Row Folded	\$2,095.00	\$1,794.21
336320	TruckVault Inc.	T-HYPALS1-20S	Palisade Std 1 DwrBehind 3rd Row Seat	\$1,695.00	\$1,451.64
336320	TruckVault Inc.	T-HYPALS2-20N	Palisade Std 2 Dwr	\$2,525.00	\$2,162.47
336320	TruckVault Inc.	T-HYPALSO-20N	Palisade Std 2 Dwr Offset	\$2,525.00	\$2,162.47
336320	TruckVault Inc.	T-HYPALU1-20N	Palisade Utility 1 Dwr3rd Row Folded	\$2,195.00	\$1,879.85
336320	TruckVault Inc.	T-HYPALU1-20S	Palisade Utility 1 DwrBehind 3rd Row Seat	\$1,795.00	\$1,537.28
336320	TruckVault Inc.	T-HYSANM1-07N	Hyundai Santa Fe Mag 1 Dwr, dimensions: 31L x 45W	\$2,095.00	\$1,794.21
336320	TruckVault Inc.	T-HYSANM1-13N	Hyundai Santa Fe Mag 1 Dwr, dimensions: 32L x 43W	\$2,095.00	\$1,794.21
336320	TruckVault Inc.	T-HYSANM1-13N-ZC9600	Santa Fe Custom	\$1,915.00	\$1,640.05
336320	TruckVault Inc.	T-HYSANM1-19N	Santa Fe Mag 1 Dwr	\$2,095.00	\$1,794.21
336320	TruckVault Inc.	T-HYSANM1-19N-Z1	Santa Fe Mag 1 Dwr	\$2,115.00	\$1,811.34
336320	TruckVault Inc.	T-HYSANM1-19N-ZC9600	Santa Fe Custom	\$1,915.00	\$1,640.05
336320	TruckVault Inc.	T-HYSANM1-19N-ZC9656	Santa Fe Mag 1 Dwr	\$2,135.00	\$1,828.46
336320	TruckVault Inc.	T-HYSANM2-07N	Hyundai Santa Fe Mag 2 Dwr, dimensions: 31L x 45W	\$2,645.00	\$2,265.24
336320	TruckVault Inc.	T-HYSANM2-13N	Santa Fe Mag 2 Dwr	\$2,645.00	\$2,265.24
336320	TruckVault Inc.	T-HYSANMO-13N	Santa Fe Mag Offset Dwr	\$2,645.00	\$2,265.24
336320	TruckVault Inc.	T-HYSANNO-19N-ZC8166	Santa Fe Cust OS Dwr	\$2,815.00	\$2,410.83
336320	TruckVault Inc.	T-HYSANS1-07N	Hyundai Santa Fe Std 1 Dwr, dimensions: 35L x 42W	\$1,895.00	\$1,622.92
336320	TruckVault Inc.	T-HYSANS1-13N	Santa Fe Std 1 Dwr	\$2,095.00	\$1,794.21
336320	TruckVault Inc.	T-HYSANS1-19N	Santa Fe Std 1 Dwr	\$1,895.00	\$1,622.92
336320	TruckVault Inc.	T-HYSANS2-07N	Hyundai Santa Fe Std 2 Dwr, dimensions: 35L x 42W	\$2,445.00	\$2,093.95
336320	TruckVault Inc.	T-HYSANS2-13N	Santa Fe Std 2 Dwr	\$2,645.00	\$2,265.24
336320	TruckVault Inc.	T-HYSANS2-19N	Santa Fe Std 2 Dwr	\$2,445.00	\$2,093.95
336320	TruckVault Inc.	T-HYSANSO-07N	Hyundai Santa Fe Std Offset Dwr, dimensions: 35L x 42W	\$2,445.00	\$2,093.95
336320	TruckVault Inc.	T-HYSANU1-13N	Santa Fe Utility 1 Dwr	\$2,195.00	\$1,879.85
336320	TruckVault Inc.	T-HYSANU1-13N-HG	Santa Fe Utility 1 Dwr	\$2,105.00	\$1,802.77

336320	TruckVault Inc.	T-HYSASM1-13N	Hyundai Santa Fe Sport Mag 1 Dwr, dimensions: 30L x 41W	\$2,095.00	\$1,794.21
336320	TruckVault Inc.	T-HYSASS1-13N	Santa Fe Sport Std 1 Dwr	\$1,895.00	\$1,622.92
336320	TruckVault Inc.	T-HYSASS2-13N	Santa Fe Sport Std 2 Dwr	\$2,445.00	\$2,093.95
336320	TruckVault Inc.	T-HYSASU2-13N	Santa Fe Sport Utility 2 Dwr	\$2,545.00	\$2,179.60
336320	TruckVault Inc.	T-HYTUCM1-05N	Hyundai Tucson Mag 1 Dwr, dimensions: 0L x 0W	\$2,095.00	\$1,794.21
336320	TruckVault Inc.	T-HYTUCM1-15N	Tucson Mag 1 Dwr	\$2,095.00	\$1,794.21
336320	TruckVault Inc.	T-HYTUCM1-15N-HG	Tucson Mag 1 Dwr	\$2,045.00	\$1,751.39
336320	TruckVault Inc.	T-HYTUCM1-15N-HT	Tucson Mag 1 DwrHeavy Duty Table Extension	\$2,790.00	\$2,389.42
336320	TruckVault Inc.	T-HYTUCM2-05N	Hyundai Tucson Mag 2 Dwr, dimensions: 0L x 0W	\$2,645.00	\$2,265.24
336320	TruckVault Inc.	T-HYTUCS1-05N	Hyundai Tucson Std 1 Dwr, dimensions: 25L x 39W	\$1,895.00	\$1,622.92
336320	TruckVault Inc.	T-HYTUCS1-15N	Hyundai Tucson Std 1 Dwr, dimensions: 26L x 39W	\$1,895.00	\$1,622.92
336320	TruckVault Inc.	T-HYTUCS1-15N-HG	Tucson Std 1 Dwr	\$1,845.00	\$1,580.10
336320	TruckVault Inc.	T-HYTUCS2-05N	Hyundai Tucson Std 2 Dwr, dimensions: 25L x 39W	\$2,445.00	\$2,093.95
336320	TruckVault Inc.	T-HYTUCS2-15N	Tucson Std 2 Dwr	\$2,445.00	\$2,093.95
336320	TruckVault Inc.	T-HYTUCS2-15N	Tucson Std OS Dwr	\$2,445.00	\$2,093.95
336320	TruckVault Inc.	T-HYTUCU1-15N-HG	Tucson Utility 1 Dwr	\$1,945.00	\$1,665.74
336320	TruckVault Inc.	T-HYVELL1-18N	Veloster Lid	\$1,495.00	\$1,280.35
336320	TruckVault Inc.	T-HYVERM1-07N	Hyundai Veracruz Mag 1 Dwr, dimensions: 0L x 0W	\$2,225.00	\$1,905.54
336320	TruckVault Inc.	T-HYVERM2-07N	Hyundai Veracruz Mag 2 Dwr, dimensions: 0L x 0W	\$2,725.00	\$2,333.75
336320	TruckVault Inc.	T-HYVERS1-07N	Hyundai Veracruz Std 1 Dwr, dimensions: 0L x 0W	\$2,025.00	\$1,734.26
336320	TruckVault Inc.	T-HYVERS2-07N	Hyundai Veracruz Std 2 Dwr, dimensions: 0L x 0W	\$2,525.00	\$2,162.47
336320	TruckVault Inc.	T-IHS2TS2-72N	Scout Std 2 Dwr	\$2,845.00	\$2,436.52
336320	TruckVault Inc.	T-INEX3M1-08N	Infiniti EX35/37 Mag 1 Dwr, dimensions: 0L x 0W	\$2,225.00	\$1,905.54
336320	TruckVault Inc.	T-INEX3M2-08N	Infiniti EX35/37 Mag 2 Dwr, dimensions: 0L x 0W	\$2,725.00	\$2,333.75
336320	TruckVault Inc.	T-INEX3S1-08N	Infiniti EX35/37 Std 1 Dwr, dimensions: 0L x 0W	\$2,025.00	\$1,734.26
336320	TruckVault Inc.	T-INEX3S2-08N	Infiniti EX35/37 Std 2 Dwr, dimensions: 0L x 0W	\$2,525.00	\$2,162.47
336320	TruckVault Inc.	T-INFXNM1-03N	Infiniti FX35/45 Mag 1 Dwr, dimensions: 0L x 0W	\$2,225.00	\$1,905.54
336320	TruckVault Inc.	T-INFXNM2-03N	Infiniti FX35/45 Mag 2 Dwr, dimensions: 0L x 0W	\$2,725.00	\$2,333.75
336320	TruckVault Inc.	T-INFXNS1-03N	Infiniti FX35/45 Std 1 Dwr, dimensions: 0L x 0W	\$2,025.00	\$1,734.26
336320	TruckVault Inc.	T-INFXNS1-09N	FX35/45 Std 1 Dwr	\$1,895.00	\$1,622.92
336320	TruckVault Inc.	T-INFXNS2-03N	Infiniti FX35/45 Std 2 Dwr, dimensions: 0L x 0W	\$2,525.00	\$2,162.47
336320	TruckVault Inc.	T-INFXNS2-09N	FX35/45 Std 2 Dwr	\$2,445.00	\$2,093.95
336320	TruckVault Inc.	T-INFXNSO-09N	Infiniti FX35/45 Std Offset Dwr, dimensions: 26L x 41W	\$2,445.00	\$2,093.95
336320	TruckVault Inc.	T-INQX0S2-13N	Infiniti QX50 Std 2 Dwr, dimensions: 0L x 0W	\$2,525.00	\$2,162.47
336320	TruckVault Inc.	T-INQX0S2-13N-PT	Infiniti QX50 Std 2 Dwr, dimensions: 39L x 48W	\$3,340.00	\$2,860.45
336320	TruckVault Inc.	T-INQX5M1-04N	Infiniti QX56 Mag 1 Dwr, dimensions: 37.5L x 48W	\$2,295.00	\$1,965.49
336320	TruckVault Inc.	T-INQX5M2-04N	Infiniti QX56 Mag 2 Dwr, dimensions: 37.5L x 48W	\$2,845.00	\$2,436.52
336320	TruckVault Inc.	T-INQX5S1-04N	Infiniti QX56 Std 1 Dwr, dimensions: 40L x 48W	\$2,095.00	\$1,794.21
336320	TruckVault Inc.	T-INQX5S1-11N-PW	QX56/80 Std 1 Dwr	\$1,695.00	\$1,451.64
336320	TruckVault Inc.	T-INQX5S1-11S	QX56/80 Std 1 Dwr	\$1,695.00	\$1,451.64
336320	TruckVault Inc.	T-INQX5S2-04N	Infiniti QX56 Std 2 Dwr, dimensions: 40L x 48W	\$2,645.00	\$2,265.24
336320	TruckVault Inc.	T-INQX5S2-04N-PT	Infiniti QX56 Std 2 Dwr, dimensions: 39L x 48W	\$3,340.00	\$2,860.45
336320	TruckVault Inc.	T-INQX5S2-11N	QX56/80 Std 2 Dwr	\$2,645.00	\$2,265.24
336320	TruckVault Inc.	T-INQX6M1-13N	QX60 Mag 1 Dwr	\$2,295.00	\$1,965.49
336320	TruckVault Inc.	T-INQX6S1-13N	QX60 Std 1 Dwr	\$2,095.00	\$1,794.21
336320	TruckVault Inc.	T-INQX6S1-13S	QX80 Std 1 Dwr	\$1,695.00	\$1,451.64
336320	TruckVault Inc.	T-INQX8M1-11N	QX80 Mag 1 Dwr3rd Seat Folded	\$2,435.00	\$2,085.39
336320	TruckVault Inc.	T-INQX8S1-11S	QX80 Std 1 Dwr	\$1,695.00	\$1,451.64
336320	TruckVault Inc.	T-IZRODS1-98N	Rodeo Std 1 Dwr	\$1,695.00	\$1,451.64
336320	TruckVault Inc.	T-IZTRPM2-92N	Trooper Mag 2 Dwr	\$2,645.00	\$2,265.24
336320	TruckVault Inc.	T-IZTRPSO-92N	Isuzu Trooper Std Offset Dwrs, dimensions: 35.5L x 39.5W	\$2,445.00	\$2,093.95
336320	TruckVault Inc.	T-JPCHSM1-14N	Jeep Cherokee Mag 1 Dwr, dimensions: 24L x 37W	\$2,095.00	\$1,794.21
336320	TruckVault Inc.	T-JPCHSM1-14N-HG	Cherokee Mag 1 Dwr	\$2,045.00	\$1,751.39
336320	TruckVault Inc.	T-JPCHSM1-14N-HT	Cherokee Mag 1 Dwr	\$2,720.00	\$2,329.47
336320	TruckVault Inc.	T-JPCHSM1-19N	Cherokee Mag 1 Dwr	\$2,095.00	\$1,794.21
336320	TruckVault Inc.	T-JPCHSM1-19N-HG	Cherokee Mag 1 Dwr	\$2,045.00	\$1,751.39
336320	TruckVault Inc.	T-JPCHSM1-89N	Jeep Cherokee Mag 1 Dwr, dimensions: 27L x 42W	\$2,095.00	\$1,794.21
336320	TruckVault Inc.	T-JPCHSM1-89N-PT	Jeep Cherokee Mag 1 Dwr, dimensions: 26L x 43W	\$2,790.00	\$2,389.42
336320	TruckVault Inc.	T-JPCHSM1-89N-S9	Jeep Cherokee Mag 1 Dwr, dimensions: 27L x 38W	\$2,095.00	\$1,794.21
336320	TruckVault Inc.	T-JPCHSM1-90N-S6	Jeep Cherokee Mag 1 Dwr, dimensions: 27L x 40W	\$2,095.00	\$1,794.21
336320	TruckVault Inc.	T-JPCHSM1-97N	Jeep Cherokee Mag 1 Dwr, dimensions: 27L x 42W	\$2,095.00	\$1,794.21
336320	TruckVault Inc.	T-JPCHSM1-97N-S9	Jeep Cherokee Mag 1 Dwr, dimensions: 27L x 38W	\$2,095.00	\$1,794.21
336320	TruckVault Inc.	T-JPCHSM2-14N	Jeep Cherokee Mag 2 Dwr, dimensions: 24L x 37W	\$2,645.00	\$2,265.24
336320	TruckVault Inc.	T-JPCHSM2-89N	Jeep Cherokee Mag 2 Dwr, dimensions: 27L x 42W	\$2,645.00	\$2,265.24
336320	TruckVault Inc.	T-JPCHSM2-90N-S6	Jeep Cherokee Mag 2 Dwr, dimensions: 27L x 40W	\$2,645.00	\$2,265.24
336320	TruckVault Inc.	T-JPCHSM2-97N-S9	Jeep Cherokee Mag 2 Dwr, dimensions: 27L x 38W	\$2,645.00	\$2,265.24



336320	TruckVault Inc.	T-JPCHSMO-14N	Cherokee Mag OS Dwr	\$2,645.00	\$2,265.24
336320	TruckVault Inc.	T-JPCHSMO-89N-PT	Jeep Cherokee Mag Offset, dimensions: 26L x 43W	\$3,340.00	\$2,860.45
336320	TruckVault Inc.	T-JPCHSN1-19N-ZC8796	Cherokee Cust 1 Dwr	\$2,305.00	\$1,974.06
336320	TruckVault Inc.	T-JPCHSS1-14N	Jeep Cherokee Std 1 Dwr, dimensions: 26L x 37W	\$1,895.00	\$1,622.92
336320	TruckVault Inc.	T-JPCHSS1-14N-HG	Cherokee Std 1 Dwr	\$1,845.00	\$1,580.10
336320	TruckVault Inc.	T-JPCHSS1-19N	Cherokee Std 1 Dwr	\$1,895.00	\$1,622.92
336320	TruckVault Inc.	T-JPCHSS1-19N-HG	Cherokee Std 1 Dwr	\$1,845.00	\$1,580.10
336320	TruckVault Inc.	T-JPCHSS1-84N	Cherokee Std 1 Dwr	\$1,895.00	\$1,622.92
336320	TruckVault Inc.	T-JPCHSS1-89N	Jeep Cherokee Std 1 Dwr, dimensions: 27L x 43W	\$1,895.00	\$1,622.92
336320	TruckVault Inc.	T-JPCHSS1-90N-S6	Jeep Cherokee Std 1 Dwr, dimensions: 1L x 1W	\$1,895.00	\$1,622.92
336320	TruckVault Inc.	T-JPCHSS1-93N-S9	Jeep Cherokee Std 1 Dwr, dimensions: 29L x 38W	\$1,895.00	\$1,622.92
336320	TruckVault Inc.	T-JPCHSS1-97N-S6	Jeep Cherokee Std 1 Dwr, dimensions: 29L x 40W	\$1,895.00	\$1,622.92
336320	TruckVault Inc.	T-JPCHSS1-97N-S9	Jeep Cherokee Std 1 Dwr, dimensions: 27L x 38W	\$1,895.00	\$1,622.92
336320	TruckVault Inc.	T-JPCHSS2-14N	Jeep Cherokee Std 2 Dwr, dimensions: 26L x 37W	\$2,445.00	\$2,093.95
336320	TruckVault Inc.	T-JPCHSS2-19N	Cherokee Std 2 Dwr	\$2,445.00	\$2,093.95
336320	TruckVault Inc.	T-JPCHSS2-89N	Jeep Cherokee Std 2 Dwr, dimensions: 27L x 43W	\$2,445.00	\$2,093.95
336320	TruckVault Inc.	T-JPCHSS2-97N-S6	Jeep Cherokee Std 2 Dwr, dimensions: 29L x 40W	\$2,445.00	\$2,093.95
336320	TruckVault Inc.	T-JPCHSS2-97N-S9	Jeep Cherokee Std 2 Dwr, dimensions: 29L x 38W	\$1,995.00	\$1,708.56
336320	TruckVault Inc.	T-JPCHSSO-14N	Jeep Cherokee Std Offset Dwr, dimensions: 26L x 37W	\$2,445.00	\$2,093.95
336320	TruckVault Inc.	T-JPCHSSO-93N-S9	Jeep Cherokee Std OS Dwr, dimensions: 29L x 38W	\$2,445.00	\$2,093.95
336320	TruckVault Inc.	T-JPCHSSO-97N-S9	Jeep Cherokee Std OS Dwr, dimensions: 29L x 38W	\$2,445.00	\$2,093.95
336320	TruckVault Inc.	T-JPCHSU1-14N-HG	Cherokee Std 1 DwrElevated Version	\$1,945.00	\$1,665.74
336320	TruckVault Inc.	T-JPCHSU1-19N	Cherokee Utility 1 Dwr	\$1,995.00	\$1,708.56
336320	TruckVault Inc.	T-JPCHSU1-19N-HG	Cherokee Utility 1 Dwr	\$1,945.00	\$1,665.74
336320	TruckVault Inc.	T-JPCHSU1-19N-HT	Cherokee Utility 1 Dwr, HD Table	\$2,690.00	\$2,303.78
336320	TruckVault Inc.	T-JPCHSU2-14N	Cherokee Utility 2 Dwr	\$2,545.00	\$2,179.60
336320	TruckVault Inc.	T-JPCHSU2-19N-HT	Cherokee Utility 2 Dwr, HD Table	\$3,240.00	\$2,774.81
336320	TruckVault Inc.	T-JPCMDM1-06N	Jeep Commander Mag 1 Dwr, dimensions: 32.5L x 43.5W	\$2,095.00	\$1,794.21
336320	TruckVault Inc.	T-JPCMDM1-06N-PT	Jeep Commander Mag 1 Dwr, dimensions: 31.75L x 43.5W	\$2,790.00	\$2,389.42
336320	TruckVault Inc.	T-JPCMDM2-06N	Jeep Commander Mag 2 Dwr, dimensions: 32.5L x 43.5W	\$2,645.00	\$2,265.24
336320	TruckVault Inc.	T-JPCMDM1-06N-PT	Jeep Commander Std 1 Dwr, dimensions: 34.5L x 43.5W	\$1,895.00	\$1,622.92
336320	TruckVault Inc.	T-JPCMDM1-06N-TN	Jeep Commander Std 1 Dwr, dimensions: 34.5L x 42.75W	\$1,895.00	\$1,622.92
336320	TruckVault Inc.	T-JPCMDM2-06N	Jeep Commander Std 2 Dwr, dimensions: 34.5L x 43.5W	\$2,445.00	\$2,093.95
336320	TruckVault Inc.	T-JPCPSM1-07N	Jeep Compass Mag 1 Dwr, dimensions: 0L x 0W	\$2,095.00	\$1,794.21
336320	TruckVault Inc.	T-JPCPSM1-18N	Compass Mag 1 Dwr	\$1,895.00	\$1,622.92
336320	TruckVault Inc.	T-JPCPSM2-07N	Jeep Compass Mag 2 Dwr, dimensions: 0L x 0W	\$2,645.00	\$2,265.24
336320	TruckVault Inc.	T-JPCPSM1-07N	Jeep Compass Std 1 Dwr, dimensions: 27L x 38W	\$1,895.00	\$1,622.92
336320	TruckVault Inc.	T-JPCPSM1-18N	Compass Std 1 Dwr	\$1,895.00	\$1,622.92
336320	TruckVault Inc.	T-JPCPSM1-18N-HG	Compass Std 1 Dwr	\$1,745.00	\$1,494.46
336320	TruckVault Inc.	T-JPCPSM2-07N	Jeep Compass Std 2 Dwr, dimensions: 27L x 38W	\$2,445.00	\$2,093.95
336320	TruckVault Inc.	T-JPCPSU1-18N-HG	Compass Utility 1 Dwr	\$1,855.00	\$1,588.66
336320	TruckVault Inc.	T-JPGCHM1-05N	Jeep Grand Cherokee Mag 1 Dwr, dimensions: 30.5L x 43.75W	\$2,095.00	\$1,794.21
336320	TruckVault Inc.	T-JPGCHM1-05N-PT	Jeep Grand Cherokee Mag 1 Dwr, dimensions: 0L x 0W	\$2,790.00	\$2,389.42
336320	TruckVault Inc.	T-JPGCHM1-11N	Jeep Grand Cherokee Mag 1 Dwr, dimensions: 34L x 40W	\$2,095.00	\$1,794.21
336320	TruckVault Inc.	T-JPGCHM1-11N-HG	Grand Cherokee Mag 1 Dwr	\$2,245.00	\$1,922.67
336320	TruckVault Inc.	T-JPGCHM1-11N-HT	Grand Cherokee Mag 1 Dwr	\$2,790.00	\$2,389.42
336320	TruckVault Inc.	T-JPGCHM1-11N-PP	Grand Cherokee Mag 1 Dwr	\$2,095.00	\$1,794.21
336320	TruckVault Inc.	T-JPGCHM1-11N-PT	Jeep Grand Cherokee Mag 1 Dwr, dimensions: 0L x 0W	\$2,790.00	\$2,389.42
336320	TruckVault Inc.	T-JPGCHM1-11N-RD-HG	Grand Cherokee Magnum 1 Drawer	\$2,495.00	\$2,136.78
336320	TruckVault Inc.	T-JPGCHM1-93N	Jeep Grand Cherokee Mag 1 Dwr, dimensions: 31.5L x 40W	\$2,095.00	\$1,794.21
336320	TruckVault Inc.	T-JPGCHM1-93N-PT	Jeep Grand Cherokee Mag 1 Dwr, dimensions: 1L x 1W	\$2,790.00	\$2,389.42
336320	TruckVault Inc.	T-JPGCHM1-93N-S6	Jeep Grand Cherokee Mag 1 Dwr, dimensions: 29L x 35W	\$1,895.00	\$1,622.92
336320	TruckVault Inc.	T-JPGCHM1-93N-S9	Jeep Grand Cherokee Mag 1 Dwr, dimensions: 28L x 32W	\$1,895.00	\$1,622.92
336320	TruckVault Inc.	T-JPGCHM1-99N	Jeep Grand Cherokee Mag 1 Dwr, dimensions: 30.5L x 37.5W	\$2,095.00	\$1,794.21
336320	TruckVault Inc.	T-JPGCHM1-99N-PM	Jeep Grand Cherokee Mag 1 Dwr, dimensions: 30.5L x 37.5W	\$2,095.00	\$1,794.21
336320	TruckVault Inc.	T-JPGCHM2-05N	Jeep Grand Cherokee Mag 2 Dwr, dimensions: 30.5L x 43.75W	\$2,645.00	\$2,265.24
336320	TruckVault Inc.	T-JPGCHM2-05N-PT	Jeep Grand Cherokee Mag 2 Dwr, dimensions: 29.5L x 43.75W	\$3,340.00	\$2,860.45
336320	TruckVault Inc.	T-JPGCHM2-11N	Jeep Grand Cherokee Mag 2 Dwr, dimensions: 34L x 40W	\$2,645.00	\$2,265.24
336320	TruckVault Inc.	T-JPGCHM2-11N-HT	Grand Cherokee Mag 2 Dwr	\$3,340.00	\$2,860.45
336320	TruckVault Inc.	T-JPGCHM2-11N-PP	Jeep Grand Cherokee Mag 2 Dwr, dimensions: 0L x 0W	\$2,645.00	\$2,265.24
336320	TruckVault Inc.	T-JPGCHM2-11N-PT	Jeep Grand Cherokee Mag 2 Dwr, dimensions: 0L x 0W	\$3,340.00	\$2,860.45
336320	TruckVault Inc.	T-JPGCHM2-93N	Jeep Grand Cherokee Mag 2 Dwr, dimensions: 31.5L x 40W	\$2,645.00	\$2,265.24
336320	TruckVault Inc.	T-JPGCHM2-93N-S6	Jeep Grand Cherokee Mag 2 Dwr, dimensions: 29L x 35W	\$2,445.00	\$2,093.95
336320	TruckVault Inc.	T-JPGCHM2-93N-S9	Jeep Grand Cherokee Mag 2 Dwr, dimensions: 29L x 32W	\$2,445.00	\$2,093.95
336320	TruckVault Inc.	T-JPGCHM2-99N	Jeep Grand Cherokee Mag 2 Dwr, dimensions: 30.5L x 37.5W	\$2,645.00	\$2,265.24
336320	TruckVault Inc.	T-JPGCHMO-05N	Jeep Grand Cherokee Mag OS Dwr, dimensions: 30.5L x 43.75W	\$2,645.00	\$2,265.24

336320	TruckVault Inc.	T-JPGCHMO-05N-PT	Jeep Grand Cherokee Mag OS Dwr, dimensions: 29.5L x 43.75W	\$3,340.00	\$2,860.45
336320	TruckVault Inc.	T-JPGCHMO-11N	Jeep Grand Cherokee Mag Offset, dimensions: 34L x 40W	\$2,645.00	\$2,265.24
336320	TruckVault Inc.	T-JPGCHMO-99N	Jeep Grand Cherokee Mag OS Dwr, dimensions: 30.5L x 37.5W	\$2,645.00	\$2,265.24
336320	TruckVault Inc.	T-JPGCHN1-11N-HG	Grand Cherokee 1 Dwr	\$2,145.00	\$1,837.03
336320	TruckVault Inc.	T-JPGCHN1-11N-ZC8939	Grand Cherokee Custom	\$2,335.00	\$1,999.75
336320	TruckVault Inc.	T-JPGCHN1-11N-ZC9192	Grand Cherokee Custom 1 Drawer	\$2,485.00	\$2,128.21
336320	TruckVault Inc.	T-JPGCHS1-00N	Jeep Grand Cherokee Std 1 Dwr, dimensions: 32L x 37.5W	\$1,895.00	\$1,622.92
336320	TruckVault Inc.	T-JPGCHS1-05N	Jeep Grand Cherokee Std 1 Dwr, dimensions: 32L x 43.75W	\$1,895.00	\$1,622.92
336320	TruckVault Inc.	T-JPGCHS1-05N-PT	Jeep Grand Cherokee Std 1 Dwr, dimensions: 31.5L x 45W	\$2,590.00	\$2,218.14
336320	TruckVault Inc.	T-JPGCHS1-11N	Jeep Grand Cherokee Std 1 Dwr, dimensions: 36L x 40W	\$2,095.00	\$1,794.21
336320	TruckVault Inc.	T-JPGCHS1-11N-HG	Grand Cherokee Std 1 Dwr	\$2,045.00	\$1,751.39
336320	TruckVault Inc.	T-JPGCHS1-11N-HG-ZC11369	Grand Cherokee Std 1 Dwr	\$2,035.00	\$1,742.82
336320	TruckVault Inc.	T-JPGCHS1-11N-HT	Grand Cherokee Std 1 Dwr	\$2,590.00	\$2,218.14
336320	TruckVault Inc.	T-JPGCHS1-11N-PT	Jeep Grand Cherokee Std 1 Dwr, dimensions: 34L x 40W	\$2,590.00	\$2,218.14
336320	TruckVault Inc.	T-JPGCHS1-93N	Jeep Grand Cherokee Std 1 Dwr, dimensions: 31.5L x 40W	\$1,895.00	\$1,622.92
336320	TruckVault Inc.	T-JPGCHS1-93N-S6	Jeep Grand Cherokee Std 1 Dwr, dimensions: 31L x 35W	\$1,695.00	\$1,451.64
336320	TruckVault Inc.	T-JPGCHS1-93N-S9	Jeep Grand Cherokee Std 1 Dwr, dimensions: 31L x 32W	\$1,695.00	\$1,451.64
336320	TruckVault Inc.	T-JPGCHS1-99N	Jeep Grand Cherokee Std 1 Dwr, dimensions: 32L x 37.5W	\$1,895.00	\$1,622.92
336320	TruckVault Inc.	T-JPGCHS1-99N-PM	Jeep Grand Cherokee Std 1 Dwr, dimensions: 32L x 37.5W	\$1,895.00	\$1,622.92
336320	TruckVault Inc.	T-JPGCHS2-05N	Jeep Grand Cherokee Std 2 Dwr, dimensions: 32.5L x 43.75W	\$2,445.00	\$2,093.95
336320	TruckVault Inc.	T-JPGCHS2-11N	Jeep Grand Cherokee Std 2 Dwr, dimensions: 36L x 40W	\$2,645.00	\$2,265.24
336320	TruckVault Inc.	T-JPGCHS2-11N-HT	Grand Cherokee Std 2 Dwr	\$3,160.00	\$2,706.30
336320	TruckVault Inc.	T-JPGCHS2-11N-PP	Jeep Grand Cherokee Std 2 Dwr, dimensions: 31L x 40W	\$2,445.00	\$2,093.95
336320	TruckVault Inc.	T-JPGCHS2-11N-PT	Jeep Grand Cherokee Std 2 Dwr, dimensions: 34L x 40W	\$3,140.00	\$2,689.17
336320	TruckVault Inc.	T-JPGCHS2-11N-ZC8055	Grand Cherokee Std 2 Dwr	\$2,515.00	\$2,153.90
336320	TruckVault Inc.	T-JPGCHS2-93N-S6	Jeep Grand Cherokee Std 2 Dwr, dimensions: 31L x 35W	\$2,245.00	\$1,922.67
336320	TruckVault Inc.	T-JPGCHS2-93N-S9	Jeep Grand Cherokee Std 2 Dwr, dimensions: 31L x 32W	\$2,245.00	\$1,922.67
336320	TruckVault Inc.	T-JPGCHS2-99N	Jeep Grand Cherokee Std 2 Dwr, dimensions: 32L x 37.5W	\$2,445.00	\$2,093.95
336320	TruckVault Inc.	T-JPGCHSO-05N	Jeep Grand Cherokee Std OS Dwr, dimensions: 34L x 40W	\$2,445.00	\$2,093.95
336320	TruckVault Inc.	T-JPGCHSO-11N	Jeep Grand Cherokee Std Offset, dimensions: 34L x 40W	\$2,445.00	\$2,093.95
336320	TruckVault Inc.	T-JPGCHSO-93N	Grand Cherokee Std OS Dwr	\$2,445.00	\$2,093.95
336320	TruckVault Inc.	T-JPGCHSO-93N-S9	Jeep Grand Cherokee Std OS Dwr, dimensions: 0L x 0W	\$2,245.00	\$1,922.67
336320	TruckVault Inc.	T-JPGCHSO-99N	Jeep Grand Cherokee Std OS Dwr, dimensions: 32.5L x 43.75W	\$2,445.00	\$2,093.95
336320	TruckVault Inc.	T-JPGCHU1-05N	Grand Cherokee Utility 1 Dwr	\$1,995.00	\$1,708.56
336320	TruckVault Inc.	T-JPGCHU1-11N	Grand Cherokee Utility 1 Dwr	\$1,995.00	\$1,708.56
336320	TruckVault Inc.	T-JPGCHU1-11N-HG	Grand Cherokee Utility 1 DwrElevated Version	\$2,145.00	\$1,837.03
336320	TruckVault Inc.	T-JPGCHU1-11N-HT	Grand Cherokee Utility 1 Dwr	\$2,690.00	\$2,303.78
336320	TruckVault Inc.	T-JPGCHU2-11N	Grand Cherokee Utility 2 Dwr	\$2,545.00	\$2,179.60
336320	TruckVault Inc.	T-JPGCHU2-11N-HT	Grand Cherokee Utility 2 Dwr	\$3,240.00	\$2,774.81
336320	TruckVault Inc.	T-JPGCHUO-11N	Grand Cherokee Utility Offset	\$2,545.00	\$2,179.60
336320	TruckVault Inc.	T-JPGDRM1-20S-HD-PW	Gladiator Mag 1Dwr1/2 Width Driver's All-Weather	\$2,445.00	\$2,093.95
336320	TruckVault Inc.	T-JPGDRM1-20S-HP-PW	Gladiator Mag 1Dwr1/2 Width Passenger All-Weather	\$2,445.00	\$2,093.95
336320	TruckVault Inc.	T-JPGDRM2-20S	Gladiator Mag 2 Dwr	\$3,145.00	\$2,693.45
336320	TruckVault Inc.	T-JPGDRM2-20S-PW	Gladiator Mag 2 Dwr	\$3,945.00	\$3,378.59
336320	TruckVault Inc.	T-JPGDRMO-20S-PW	Gladiator Mag Offset Dwr	\$3,945.00	\$3,378.59
336320	TruckVault Inc.	T-JPGDRS1-20S-HD	Gladiator Std 1 Dwr	\$2,025.00	\$1,734.26
336320	TruckVault Inc.	T-JPGDRS1-20S-ZC11596B	Gladiator Custom Standard 1 Drawer	\$2,025.00	\$1,734.26
336320	TruckVault Inc.	T-JPGDRS2-20S	Gladiator Std 2 Dwr	\$2,945.00	\$2,522.17
336320	TruckVault Inc.	T-JPGDRS2-20S-PW	Gladiator Std 2 Dwr	\$3,745.00	\$3,207.30
336320	TruckVault Inc.	T-JPGDRSO-20S	Gladiator Std 2 Dwr Offset	\$2,945.00	\$2,522.17
336320	TruckVault Inc.	T-JPGDRSO-20S-PW	Gladiator Std Offset Dwr	\$3,745.00	\$3,207.30
336320	TruckVault Inc.	T-JPGDRU1-20S-HD-PW	Gladiator Utility 1Dwr	\$2,345.00	\$2,008.31
336320	TruckVault Inc.	T-JPGDRU1-20S-HP	Gladiator Utility 1Dwr	\$2,095.00	\$1,794.21
336320	TruckVault Inc.	T-JPGDRU1-20S-HP-PW	Gladiator Utility 1Dwr	\$2,345.00	\$2,008.31
336320	TruckVault Inc.	T-JPGDRU1-20S-ZC11158	Gladiator Utility 1DwrC11158	\$1,875.00	\$1,605.79
336320	TruckVault Inc.	T-JPGDRU2-20S	Gladiator Utility 2 Dwr	\$3,045.00	\$2,607.81
336320	TruckVault Inc.	T-JPGDRU2-20S-PW	Gladiator Utility 2 Dwr	\$3,845.00	\$3,292.95
336320	TruckVault Inc.	T-JPGDRUO-20S-PW	Gladiator Utility 2 Dwr OffsetAll-Weather	\$3,845.00	\$3,292.95
336320	TruckVault Inc.	T-JPGRWN2-85N-ZC10992A	Grande Wagoneer CustomC10992A	\$2,955.00	\$2,530.73
336320	TruckVault Inc.	T-JPLIBM1-08N	Jeep Liberty Mag 1 Dwr, dimensions: 27L x 40.5W	\$2,095.00	\$1,794.21
336320	TruckVault Inc.	T-JPLIBM1-08N-PP	Jeep Liberty Mag 1 Dwr, dimensions: 24L x 40.5W	\$2,095.00	\$1,794.21
336320	TruckVault Inc.	T-JPLIBM2-08N	Jeep Liberty Mag 2 Dwr, dimensions: 27L x 40.5W	\$2,645.00	\$2,265.24
336320	TruckVault Inc.	T-JPLIBS1-08N	Jeep Liberty Std 1 Dwr, dimensions: 28.5L x 40.5W	\$1,895.00	\$1,622.92
336320	TruckVault Inc.	T-JPLIBS2-08N	Jeep Liberty Std 2 Dwr, dimensions: 28.5L x 40.5W	\$2,445.00	\$2,093.95
336320	TruckVault Inc.	T-JPLIBSO-02N	Jeep Liberty Std Offset Dwr, dimensions: 22.5L x 37.25W	\$2,245.00	\$1,922.67
336320	TruckVault Inc.	T-JPPATM1-07N	Jeep Patriot Mag 1 Dwr, dimensions: 25L x 38W	\$2,095.00	\$1,794.21

336320	TruckVault Inc.	T-JPPATM2-07N	Jeep Patriot Mag 2 Dwr, dimensions: 25L x 38W	\$2,645.00	\$2,265.24
336320	TruckVault Inc.	T-JPPATMO-07N	Patriot Mag Offset Dwr	\$2,645.00	\$2,265.24
336320	TruckVault Inc.	T-JPPATS1-07N	Jeep Patriot Std 1 Dwr, dimensions: 27L x 38W	\$1,895.00	\$1,622.92
336320	TruckVault Inc.	T-JPPATS2-07N	Jeep Patriot Std 2 Dwr, dimensions: 27L x 38W	\$2,445.00	\$2,093.95
336320	TruckVault Inc.	T-JPRENM1-15N	Jeep Renegade Mag 1 Dwr, dimensions: 21L x 37W	\$1,895.00	\$1,622.92
336320	TruckVault Inc.	T-JPRENS1-15N	Jeep Renegade Std 1 Dwr, dimensions: 23L x 37W	\$1,695.00	\$1,451.64
336320	TruckVault Inc.	T-JPW2DS1-18S	Wrangler 2 Door Std 1 Dwr	\$1,695.00	\$1,451.64
336320	TruckVault Inc.	T-JPW2DU2-18N-TT	Wrangler 2 Door Utility 2 Dwr	\$3,840.00	\$3,288.66
336320	TruckVault Inc.	T-JPW4DM1-18N	Wrangler 4 Door Mag 1 Dwr	\$2,095.00	\$1,794.21
336320	TruckVault Inc.	T-JPW4DM1-18N-HT	Wrangler 4 Door Mag 1 Dwr	\$2,790.00	\$2,389.42
336320	TruckVault Inc.	T-JPW4DM1-18N-PW	Wrangler 4 Door Mag 1 Dwr	\$2,395.00	\$2,051.13
336320	TruckVault Inc.	T-JPW4DM1-18N-ZC8922	Wrangler 4 Door Mag 1 Dwr	\$1,915.00	\$1,640.05
336320	TruckVault Inc.	T-JPW4DM1-18N-ZC9136	Wrangler 4 Door Mag 1 Dwr	\$1,915.00	\$1,640.05
336320	TruckVault Inc.	T-JPW4DM2-18N	Wrangler 4 Door Mag 2 Dwr	\$2,645.00	\$2,265.24
336320	TruckVault Inc.	T-JPW4DM2-18N-HT	Wrangler 4 Door Mag 2 DwrHD Table Ext.	\$3,340.00	\$2,860.45
336320	TruckVault Inc.	T-JPW4DN1-18N-ZC8089	Wrangler 4 Door Custom 1 Dwr	\$2,255.00	\$1,931.23
336320	TruckVault Inc.	T-JPW4DS1-18N	Wrangler 4 Door Std 1 Dwr	\$1,895.00	\$1,622.92
336320	TruckVault Inc.	T-JPW4DS1-18N-PW	Wrangler 4 Door Std 1 Dwr	\$2,195.00	\$1,879.85
336320	TruckVault Inc.	T-JPW4DS1-18N-PW-ZC10463	Wrangler 4 Door Std 1 DwrA-Wthr; C10463	\$2,115.00	\$1,811.34
336320	TruckVault Inc.	T-JPW4DS1-18N-ZC10787A	Wrangler 4 Door Std 1 DwrC10787A	\$1,905.00	\$1,631.49
336320	TruckVault Inc.	T-JPW4DS2-18N	Wrangler 4 Door Std 2 Dwr	\$2,445.00	\$2,093.95
336320	TruckVault Inc.	T-JPW4DS2-18N-HT	Wrangler 4 Door Std 2 Dwr	\$2,940.00	\$2,517.88
336320	TruckVault Inc.	T-JPW4DS2-18N-PW	Wrangler 4 Door Std 2 Dwr	\$2,645.00	\$2,265.24
336320	TruckVault Inc.	T-JPW4DSO-18N	Wrangler 4 Door Std OS Dwr	\$2,445.00	\$2,093.95
336320	TruckVault Inc.	T-JPW4DU1-18N	Wrangler 4 Door Utility 1 Dwr	\$1,995.00	\$1,708.56
336320	TruckVault Inc.	T-JPW4DU1-18N-HT-PW	Wrangler 4 Door Utility 1 DwrAll-Weather HD Table	\$2,990.00	\$2,560.71
336320	TruckVault Inc.	T-JPW4DU2-18N	Wrangler 4 Door Utility 2 Dwr	\$2,545.00	\$2,179.60
336320	TruckVault Inc.	T-JPW4DUO-18N	Wrangler 4 Door Utility Offset Dwr	\$2,545.00	\$2,179.60
336320	TruckVault Inc.	T-JPW4DUO-18N-PT	Wrangler 4 Door Utility Offset	\$2,890.00	\$2,475.06
336320	TruckVault Inc.	T-JPWAVM2-11N	Wrangler AEV Magnum	\$2,985.00	\$2,556.42
336320	TruckVault Inc.	T-JPWAVM2-11N-HT-PW	Wrangler AEV Mag 2 Dwr	\$3,740.00	\$3,203.02
336320	TruckVault Inc.	T-JPWAVM2-11N-PW	Wrangler AEV Mag 1 Dwr	\$3,045.00	\$2,607.81
336320	TruckVault Inc.	T-JPWAVS2-11N	Jeep Wrangler AEV, dimensions: 57L x 41W	\$2,755.00	\$2,359.45
336320	TruckVault Inc.	T-JPWAVS2-11N-PW	Wrangler AEV Std 2 Dwr	\$2,845.00	\$2,436.52
336320	TruckVault Inc.	T-JPWGRM1-07N-TR	Jeep Wrangler Mag 1 Dwr, dimensions: 38L x 39.5W	\$2,215.00	\$1,896.98
336320	TruckVault Inc.	T-JPWGRM1-07N-TR-HT	Wrangler Mag 1 Dwr	\$2,990.00	\$2,560.71
336320	TruckVault Inc.	T-JPWGRM1-07N-TR-PK	Wrangler Mag 1 Dwr	\$2,095.00	\$1,794.21
336320	TruckVault Inc.	T-JPWGRM1-07N-TR-PW	Jeep Wrangler Mag 1 Dwr, dimensions: 38L x 39.5W	\$2,695.00	\$2,308.06
336320	TruckVault Inc.	T-JPWGRM1-87N	Jeep Wrangler Mag 1 Dwr, dimensions: 38L x 35.5W	\$2,095.00	\$1,794.21
336320	TruckVault Inc.	T-JPWGRM1-97N	Jeep Wrangler Mag 1 Dwr, dimensions: 33L x 33W	\$1,895.00	\$1,622.92
336320	TruckVault Inc.	T-JPWGRM1-99N-TR	Jeep Wrangler Mag 1 Dwr, dimensions: 32L x 33W	\$1,895.00	\$1,622.92
336320	TruckVault Inc.	T-JPWGRM1-99N-TR-PW	Jeep Wrangler Mag 1 Dwr, dimensions: 32L x 33.5W	\$2,195.00	\$1,879.85
336320	TruckVault Inc.	T-JPWGRMO-99N-TR	Jeep Wrangler Mag OS Dwr, dimensions: 32L x 33.5W	\$2,445.00	\$2,093.95
336320	TruckVault Inc.	T-JPWGRS1-07N-TR	Jeep Wrangler Std 1 Dwr, dimensions: 40L x 39.5W	\$1,995.00	\$1,708.56
336320	TruckVault Inc.	T-JPWGRS1-07N-TR-PK	Jeep Wrangler Std 1 Dwr, dimensions: 40L x 34.5W	\$1,895.00	\$1,622.92
336320	TruckVault Inc.	T-JPWGRS1-07N-TR-PK-PT	Wrangler Std 1 Dwr	\$2,590.00	\$2,218.14
336320	TruckVault Inc.	T-JPWGRS1-07N-TR-PT	Jeep Wrangler Std 1 Dwr, dimensions: 38L x 39.5W	\$2,695.00	\$2,308.06
336320	TruckVault Inc.	T-JPWGRS1-07N-TR-PW	Wrangler Std 1 Dwr	\$2,495.00	\$2,136.78
336320	TruckVault Inc.	T-JPWGRS1-87N-TR	Jeep Wrangler Std 1 Dwr, dimensions: 40L x 34W	\$1,895.00	\$1,622.92
336320	TruckVault Inc.	T-JPWGRS1-97N	Jeep Wrangler Std 1 Dwr, dimensions: 25L x 33.5W	\$1,695.00	\$1,451.64
336320	TruckVault Inc.	T-JPWGRS1-99N-TR	Jeep Wrangler Std 1 Dwr, dimensions: 32L x 33.5W	\$1,695.00	\$1,451.64
336320	TruckVault Inc.	T-JPWGRS2-07N-TR-HT	Wrangler Std 2 DwrSeat Removed; HD Table Extension	\$3,340.00	\$2,860.45
336320	TruckVault Inc.	T-JPWGRS2-07N-TR-PT	Wrangler Std 2 Dwr	\$3,340.00	\$2,860.45
336320	TruckVault Inc.	T-JPWGRS2-07N-TR-PW	Wrangler Std 2 Dwr	\$2,945.00	\$2,522.17
336320	TruckVault Inc.	T-JPWGRS2-97N-PW	Wrangler Std 2 Dwr	\$2,445.00	\$2,093.95
336320	TruckVault Inc.	T-JPWGRS2-97N-TR	Wrangler Std 2 Dwr	\$2,245.00	\$1,922.67
336320	TruckVault Inc.	T-JPWGRSO-07N-TR	Jeep Wrangler Std Offset Dwr, dimensions: 40L x 39.5W	\$2,495.00	\$2,136.78
336320	TruckVault Inc.	T-JPWGRU1-07N-TR	Wrangler Utility 1 Dwr2nd Seat Removed	\$2,095.00	\$1,794.21
336320	TruckVault Inc.	T-JPWGRU2-97N-PW	Wrangler Utility 2 Dwr	\$2,545.00	\$2,179.60
336320	TruckVault Inc.	T-JPWULM1-04N	Jeep Wrangler Unlimited Mag 1 Dwr, dimensions: 20L x 33W	\$1,695.00	\$1,451.64
336320	TruckVault Inc.	T-JPWULM1-04N-TF	Jeep Wrangler Unlimited Mag 1 Dwr, dimensions: 36L x 33W	\$2,095.00	\$1,794.21
336320	TruckVault Inc.	T-JPWULM1-04N-TR	Jeep Wrangler Unlimited Mag 1 Dwr, dimensions: 48L x 33W	\$2,215.00	\$1,896.98
336320	TruckVault Inc.	T-JPWULM1-04N-TR-PT	Jeep Wrangler Unlimited Mag 1 Dwr, dimensions: 48L x 33W	\$2,915.00	\$2,496.47
336320	TruckVault Inc.	T-JPWULM1-04N-TR-PW	Jeep Wrangler Unlimited Mag 1 Dwr, dimensions: 48L x 33.75W	\$2,795.00	\$2,393.70
336320	TruckVault Inc.	T-JPWULM1-04N-TR-PW-ZC10949	Wrangler Unlimited Mag 1 DwrC10949	\$2,745.00	\$2,350.88
336320	TruckVault Inc.	T-JPWULM1-07N	Jeep Wrangler Unlimited Mag 1 Dwr, dimensions: 28.5L x 39W	\$1,995.00	\$1,708.56

336320	TruckVault Inc.	T-JPWULM1-07N-HT	Jeep Wrangler Unlimited Mag 1 Dwr, dimensions: 25.5L x 39W	\$2,790.00	\$2,389.42
336320	TruckVault Inc.	T-JPWULM1-07N-HT-PW	Wrangler Unlimited Mag 1 Dwr	\$3,090.00	\$2,646.35
336320	TruckVault Inc.	T-JPWULM1-07N-PK	Jeep Wrangler Unlimited Mag 1 Dwr, dimensions: 28.5L x 34.5W	\$1,895.00	\$1,622.92
336320	TruckVault Inc.	T-JPWULM1-07N-PK-HT	Wrangler Unlimited Mag 1 Dwr	\$2,590.00	\$2,218.14
336320	TruckVault Inc.	T-JPWULM1-07N-PK-PT	Jeep Wrangler Unlimited Mag 1 Dwr, dimensions: 27L x 34.5W	\$2,590.00	\$2,218.14
336320	TruckVault Inc.	T-JPWULM1-07N-PK-PW	Jeep Wrangler Unlimited Mag 1 Dwr, dimensions: 28.5L x 37.75W	\$2,195.00	\$1,879.85
336320	TruckVault Inc.	T-JPWULM1-07N-PT	Wrangler Unlimited Mag 1 Dwr	\$2,790.00	\$2,389.42
336320	TruckVault Inc.	T-JPWULM1-07N-PW	Jeep Wrangler Unlimited Mag 1 Dwr, dimensions: 28.5L x 39W	\$2,395.00	\$2,051.13
336320	TruckVault Inc.	T-JPWULM2-04N-TR-HT	Wrangler Unlimited Mag 2 Dwr	\$3,340.00	\$2,860.45
336320	TruckVault Inc.	T-JPWULM2-04N-TR-PT	Jeep Wrangler Unlimited Mag 2 Dwr, dimensions: 48L x 33W	\$3,340.00	\$2,860.45
336320	TruckVault Inc.	T-JPWULM2-07N-HT	Wrangler Unlimited Mag 2 Dwr	\$3,305.00	\$2,830.48
336320	TruckVault Inc.	T-JPWULM2-07N-HT-PK	Wrangler Unlimited Mag 2 Dwr	\$3,140.00	\$2,689.17
336320	TruckVault Inc.	T-JPWULM2-07N-PK	Jeep Wrangler Unlimited Mag 2 Dwr, dimensions: 28.5L x 34.5W	\$2,445.00	\$2,093.95
336320	TruckVault Inc.	T-JPWULM2-07N-PK-PT	Jeep Wrangler Unlimited Mag 2 Dwr, dimensions: 28L x 34.5W	\$3,140.00	\$2,689.17
336320	TruckVault Inc.	T-JPWULM2-07N-PK-PW	Jeep Wrangler Unlimited Mag 2 Dwr, dimensions: 28.5L x 37.75W	\$2,645.00	\$2,265.24
336320	TruckVault Inc.	T-JPWULM2-07N-PW	Jeep Wrangler Unlimited Mag 2 Dwr, dimensions: 28L x 37.5W	\$2,845.00	\$2,436.52
336320	TruckVault Inc.	T-JPWULM2-07N-TR-HT	Wrangler Unlimited Mag 2 Dwr Heavy Duty Table #rd Seat Removed	\$3,740.00	\$3,203.02
336320	TruckVault Inc.	T-JPWULM2-07N-TR-PW	Jeep Wrangler Unlimited Mag 2 Dwr, dimensions: 56L x 37.75W	\$3,445.00	\$2,950.38
336320	TruckVault Inc.	T-JPWULM2-07N-TT	Wrangler Unlimited Mag 2 Dwr	\$3,490.00	\$2,988.92
336320	TruckVault Inc.	T-JPWULMO-07N	Jeep Wrangler Unlimited Mag OS Dwr, dimensions: 28.5L x 39W	\$2,515.00	\$2,153.90
336320	TruckVault Inc.	T-JPWULMO-07N-HT	Jeep Wrangler Unlimited Mag OS Dwr, dimensions: 28.5L x 39W	\$3,340.00	\$2,860.45
336320	TruckVault Inc.	T-JPWULMO-07N-HT-PW	Wrangler Unlimited Mag OS Dwr	\$3,540.00	\$3,031.74
336320	TruckVault Inc.	T-JPWULMO-07N-PK	Jeep Wrangler Unlimited Mag OS Dwr, dimensions: 29L x 34.5W	\$2,445.00	\$2,093.95
336320	TruckVault Inc.	T-JPWULS1-04N	Jeep Wrangler Unlimited Std 1 Dwr, dimensions: 22L x 33.75W	\$1,495.00	\$1,280.35
336320	TruckVault Inc.	T-JPWULS1-04N-TF	Jeep Wrangler Unlimited Std 1 Dwr, dimensions: 38L x 33.75W	\$1,895.00	\$1,622.92
336320	TruckVault Inc.	T-JPWULS1-04N-TR	Jeep Wrangler Unlimited Std 1 Dwr, dimensions: 50L x 33.75W	\$1,995.00	\$1,708.56
336320	TruckVault Inc.	T-JPWULS1-04N-TR-PT	Jeep Wrangler Unlimited Std 1 Dwr, dimensions: 48L x 33W	\$2,695.00	\$2,308.06
336320	TruckVault Inc.	T-JPWULS1-04N-TR-PW	Jeep Wrangler Unlimited Std 1 Dwr, dimensions: 50L x 33.75W	\$2,595.00	\$2,222.42
336320	TruckVault Inc.	T-JPWULS1-07N	Jeep Wrangler Unlimited Std 1 Dwr, dimensions: 30.5L x 39W	\$1,775.00	\$1,520.15
336320	TruckVault Inc.	T-JPWULS1-07N-HT	Wrangler Unlimited Std 1 Dwr	\$2,590.00	\$2,218.14
336320	TruckVault Inc.	T-JPWULS1-07N-PK	Jeep Wrangler Unlimited Std 1 Dwr, dimensions: 30.5L x 34.5W	\$1,695.00	\$1,451.64
336320	TruckVault Inc.	T-JPWULS1-07N-PK-HT	Wrangler Unlimited Std 1 Dwr	\$2,390.00	\$2,046.85
336320	TruckVault Inc.	T-JPWULS1-07N-PK-PT	Jeep Wrangler Unlimited Std 1 Dwr, dimensions: 29L x 34.5W	\$2,390.00	\$2,046.85
336320	TruckVault Inc.	T-JPWULS1-07N-PK-PW	Wrangler Unlimited Std 1 Dwr	\$1,995.00	\$1,708.56
336320	TruckVault Inc.	T-JPWULS1-07N-PW	Jeep Wrangler Unlimited Std 1 Dwr, dimensions: 30.5L x 39W	\$2,195.00	\$1,879.85
336320	TruckVault Inc.	T-JPWULS1-07N-TR-PW	Wrangler Unlimited Std 1 Dwr	\$2,215.00	\$1,896.98
336320	TruckVault Inc.	T-JPWULS2-04N-TF	Jeep Wrangler Unlimited Std 2 Dwr, dimensions: 38L x 33.75W	\$2,445.00	\$2,093.95
336320	TruckVault Inc.	T-JPWULS2-04N-TR	Jeep Wrangler Unlimited Std 2 Dwr, dimensions: 50L x 33W	\$2,515.00	\$2,153.90
336320	TruckVault Inc.	T-JPWULS2-07N-HT	Wrangler Unlimited Std 2 Dwr	\$3,140.00	\$2,689.17
336320	TruckVault Inc.	T-JPWULS2-07N-PK-PT	Jeep Wrangler Unlimited Std 2 Dwr, dimensions: 29.5L x 34.5W	\$2,940.00	\$2,517.88
336320	TruckVault Inc.	T-JPWULS2-07N-PT	Wrangler Unlimited Std 2 Dwr Table Ext.	\$3,140.00	\$2,689.17
336320	TruckVault Inc.	T-JPWULS2-07N-PW	Wrangler Unlimited Std 2 Dwr	\$2,445.00	\$2,093.95
336320	TruckVault Inc.	T-JPWULS2-07N-TR	Wrangler Unlimited Std 2 Dwr	\$2,325.00	\$1,991.18
336320	TruckVault Inc.	T-JPWULS2-07N-TR-PW	Wrangler Unlimited Std 2 Dwr	\$3,545.00	\$3,036.02
336320	TruckVault Inc.	T-JPWULSO-04N-TF	Jeep Wrangler Unlimited Std 2 Dwr, dimensions: 0L x 0W	\$2,445.00	\$2,093.95
336320	TruckVault Inc.	T-JPWULSO-04N-TR	Jeep Wrangler Unlimited Std 2 Dwr, dimensions: 0L x 0W	\$2,515.00	\$2,153.90
336320	TruckVault Inc.	T-JPWULSO-07N-HT	Wrangler Unlimited Std Offset Dwr HD Table Ext.	\$3,140.00	\$2,689.17
336320	TruckVault Inc.	T-JPWULSO-07N-PW	Wrangler Unlimited Std OS Dwr	\$2,645.00	\$2,265.24
336320	TruckVault Inc.	T-JPWULSO-07N-TR	Wrangler Unlimited Std OS Dwr	\$2,765.00	\$2,368.01
336320	TruckVault Inc.	T-JPWULU1-07N	Wrangler Unlimited Utility 1 Dwr	\$1,995.00	\$1,708.56
336320	TruckVault Inc.	T-JPWULU1-07N-PK	Wrangler Unlimited Utility 1 Dwr	\$1,795.00	\$1,537.28
336320	TruckVault Inc.	T-JPWULU2-07N	Wrangler Unlimited Utility 2 Dwr	\$2,545.00	\$2,179.60
336320	TruckVault Inc.	T-JPWULU2-07N-PK	Wrangler Unlimited Utility 2 Dwr	\$2,345.00	\$2,008.31
336320	TruckVault Inc.	T-JPWULU2-07N-PT	Wrangler Unlimited Utility 2 Dwr	\$3,240.00	\$2,774.81
336320	TruckVault Inc.	T-JPWULUO-07N	Wrangler Unlimited Utility Offset Dwr	\$2,545.00	\$2,179.60
336320	TruckVault Inc.	T-JPWULUO-07N-HT	Wrangler Unlimited Utility 2 Dwr Offset	\$3,240.00	\$2,774.81
336320	TruckVault Inc.	T-JREPCM1-17N	E-Pace Mag 1 Dwr	\$1,695.00	\$1,451.64
336320	TruckVault Inc.	T-JREPCS1-17N	E-Pace Std 1 Dwr	\$1,495.00	\$1,280.35
336320	TruckVault Inc.	T-JREPCU1-17N	E-Pace Utility 1 Dwr	\$1,595.00	\$1,365.99

336320	TruckVault Inc.	T-JRFPCM1-16N	F-Pace Magnum 1 Dwr	\$1,825.00	\$1,562.97
336320	TruckVault Inc.	T-JRFPCM2-16N	F-Pace Mag 2 Dwr	\$2,325.00	\$1,991.18
336320	TruckVault Inc.	T-JRFPCS1-16N	F-Pace Std 1 Dwr	\$1,695.00	\$1,451.64
336320	TruckVault Inc.	T-JRFPCU1-16N	F-Pace Utility 1 Dwr	\$1,795.00	\$1,537.28
336320	TruckVault Inc.	T-KISED1-15N	Sedona Lid Box	\$1,195.00	\$1,023.43
336320	TruckVault Inc.	T-KISED1-15N	Sedona Mag 1 Dwr3rd Seat Folded	\$2,295.00	\$1,965.49
336320	TruckVault Inc.	T-KISED2-15N	Sedona Mag 2 Dwr	\$2,845.00	\$2,436.52
336320	TruckVault Inc.	T-KISEDS1-06N	Sedona Std 1 Dwr	\$2,215.00	\$1,896.98
336320	TruckVault Inc.	T-KISEDS1-15N	Sedona Std 1 Dwr	\$2,215.00	\$1,896.98
336320	TruckVault Inc.	T-KISEDS2-09N	Kia Sedona Std 2 Dwr, dimensions: 0L x 0W	\$2,645.00	\$2,265.24
336320	TruckVault Inc.	T-KISEDS2-15N	Sedona Std 2 Dwr	\$2,645.00	\$2,265.24
336320	TruckVault Inc.	T-KISORM1-02N	Kia Sorento Mag 1 Dwr, dimensions: 27L x 36W	\$2,095.00	\$1,794.21
336320	TruckVault Inc.	T-KISORM1-11N	Kia Sorento Mag 1 Dwr, dimensions: 28L x 43W	\$2,095.00	\$1,794.21
336320	TruckVault Inc.	T-KISORM1-11N-HT	Sorento Mag 1 DwrHD Table	\$2,790.00	\$2,389.42
336320	TruckVault Inc.	T-KISORM1-14N	Sorento Mag 1 Dwr	\$2,095.00	\$1,794.21
336320	TruckVault Inc.	T-KISORM1-14N-HT	Sorento Mag 1 DwrHD Table	\$2,990.00	\$2,560.71
336320	TruckVault Inc.	T-KISORM1-14N-ZC11177	Sorento Mag 1 DwrC11177	\$2,115.00	\$1,811.34
336320	TruckVault Inc.	T-KISORM2-11N	Sorento Mag 2 Dwr	\$2,645.00	\$2,265.24
336320	TruckVault Inc.	T-KISORM2-14N	Sorento Mag 2 Dwr	\$2,645.00	\$2,265.24
336320	TruckVault Inc.	T-KISORN1-14N-C1-ZC11269	Sorento Custom 1 Dwr	\$2,425.00	\$2,076.83
336320	TruckVault Inc.	T-KISORS1-11N	Sorento Std 1 Dwr	\$1,895.00	\$1,622.92
336320	TruckVault Inc.	T-KISORS1-14N	Sorento Std 1 Dwr	\$2,095.00	\$1,794.21
336320	TruckVault Inc.	T-KISORS2-11N	Sorento Std 2 Dwr	\$2,445.00	\$2,093.95
336320	TruckVault Inc.	T-KISORS2-14N	Sorento Std 2 Dwr	\$2,645.00	\$2,265.24
336320	TruckVault Inc.	T-KISORU1-14N	Sorento Utility 1 Dwr	\$2,195.00	\$1,879.85
336320	TruckVault Inc.	T-KISOUM1-09N	Soul Mag 1 Dwr	\$1,695.00	\$1,451.64
336320	TruckVault Inc.	T-KISOUS1-09N	Soul Std 1 Dwr	\$1,495.00	\$1,280.35
336320	TruckVault Inc.	T-KISPOM1-05N	Kia Sportage Mag 1 Dwr, dimensions: 0L x 0W	\$2,095.00	\$1,794.21
336320	TruckVault Inc.	T-KISPOM1-15N	Sportage Mag 1 Dwr	\$2,095.00	\$1,794.21
336320	TruckVault Inc.	T-KISPOM2-05N	Kia Sportage Mag 2 Dwr, dimensions: 0L x 0W	\$2,645.00	\$2,265.24
336320	TruckVault Inc.	T-KISPOM2-11N	Kia Sportage Mag 2 Dwr, dimensions: 24L x 39W	\$2,645.00	\$2,265.24
336320	TruckVault Inc.	T-KISPOS1-05N	Kia Sportage Std 1 Dwr, dimensions: 26L x 39W	\$1,895.00	\$1,622.92
336320	TruckVault Inc.	T-KISPOS2-05N	Kia Sportage Std 2 Dwr, dimensions: 0L x 0W	\$2,445.00	\$2,093.95
336320	TruckVault Inc.	T-KITELM1-20N	Telluride Mag 1 Dwr	\$2,295.00	\$1,965.49
336320	TruckVault Inc.	T-KITELM2-20N-HT	Telluride Mag 2 Dwr	\$3,540.00	\$3,031.74
336320	TruckVault Inc.	T-LNAVIS1-20S	Aviator Std 1 Dwr	\$1,695.00	\$1,451.64
336320	TruckVault Inc.	T-LNAVIS2-20N	Aviator Std 2 Dwr	\$2,645.00	\$2,265.24
336320	TruckVault Inc.	T-LNMKTM1-10N	Lincoln MKT Mag 1 Dwr, dimensions: 0L x 0W	\$2,295.00	\$1,965.49
336320	TruckVault Inc.	T-LNMKTM2-10N	Lincoln MKT Mag 2 Dwr, dimensions: 0L x 0W	\$2,845.00	\$2,436.52
336320	TruckVault Inc.	T-LNMKTS1-10N	Lincoln MKT Std 1 Dwr, dimensions: 0L x 0W	\$2,095.00	\$1,794.21
336320	TruckVault Inc.	T-LNMKTS2-10N	Lincoln MKT Std 2 Dwr, dimensions: 44L x 40W	\$2,645.00	\$2,265.24
336320	TruckVault Inc.	T-LNMKXM1-07N	Lincoln MKX Mag 1 Dwr, dimensions: 30L x 38.5W	\$2,095.00	\$1,794.21
336320	TruckVault Inc.	T-LNMKXM1-11N	Lincoln MKX Mag 1 Dwr, dimensions: 31L x 41W	\$2,095.00	\$1,794.21
336320	TruckVault Inc.	T-LNMKXM2-07N	Lincoln MKX Mag 2 Dwr, dimensions: 30L x 38.5W	\$2,215.00	\$1,896.98
336320	TruckVault Inc.	T-LNMKXM2-11N	Lincoln MKX Mag 2 Dwr, dimensions: 0L x 0W	\$2,645.00	\$2,265.24
336320	TruckVault Inc.	T-LNMKXN2-11N-ZC10785	MKX Custom 2 DwrC10785	\$3,855.00	\$3,301.51
336320	TruckVault Inc.	T-LNMKXS1-07N	Lincoln MKX Std 1 Dwr, dimensions: 31L x 38.5W	\$1,895.00	\$1,622.92
336320	TruckVault Inc.	T-LNMKXS1-10N	Lincoln MKX Std 1 Dwr, dimensions: 0L x 0W	\$1,895.00	\$1,622.92
336320	TruckVault Inc.	T-LNMKXS1-11N	Lincoln MKX Std 1 Dwr, dimensions: 0L x 0W	\$1,895.00	\$1,622.92
336320	TruckVault Inc.	T-LNMKXS2-07N	Lincoln MKX Std 2 Dwr, dimensions: 31L x 38.5W	\$2,445.00	\$2,093.95
336320	TruckVault Inc.	T-LNMKXS2-11N	Lincoln MKX Std 2 Dwr, dimensions: 0L x 0W	\$2,445.00	\$2,093.95
336320	TruckVault Inc.	T-LNMLTMO-06S-PC	Lincoln Mark LT Pickup Mag OS Dwr, dimensions: 63L x 48W	\$3,545.00	\$3,036.02
336320	TruckVault Inc.	T-LNMLTMO-06S-PC-PW	Lincoln Mark LT Pickup Mag OS Dwr, dimensions: 65L x 48W	\$4,345.00	\$3,721.16
336320	TruckVault Inc.	T-LNMLTS2-06S	Mark LT Pickup Std 2 Dwr	\$3,545.00	\$3,036.02
336320	TruckVault Inc.	T-LNMLTS2-06S-PC	Lincoln Mark LT Pickup Std 2 Dwr, dimensions: 62L x 48W	\$3,345.00	\$2,864.74
336320	TruckVault Inc.	T-LNMLTS2-06S-PC-PW	Mark LT Pickup Std 2 Dwr	\$4,145.00	\$3,549.87
336320	TruckVault Inc.	T-LNMLTU2-06S-PC	Mark LT Pickup Utility 2 Dwr	\$3,445.00	\$2,950.38
336320	TruckVault Inc.	T-LNMLTU2-06S-PC-PW	Mark LT Pickup Utility 2 Dwr	\$4,245.00	\$3,635.52
336320	TruckVault Inc.	T-LNNALM2-07F	Lincoln Navigator L Mag 2 Dwr, dimensions: 0L x 0W	\$3,045.00	\$2,607.81
336320	TruckVault Inc.	T-LNNALM2-07F-PT	Lincoln Navigator L Mag 2 Dwr, dimensions: 58L x 48W	\$3,740.00	\$3,203.02
336320	TruckVault Inc.	T-LNNALM2-18F	Navigator L Mag 2 DwrMust Fold 3rd Seat	\$3,045.00	\$2,607.81
336320	TruckVault Inc.	T-LNNALM2-18F-HT	Navigator L Mag 2 DwrMust Fold 3rd Seat; Heavy Duty Table	\$3,740.00	\$3,203.02
336320	TruckVault Inc.	T-LNNALM2-18F-TR	Navigator L Mag 2 Dwr	\$3,045.00	\$2,607.81
336320	TruckVault Inc.	T-LNNALMO-07F	Lincoln Navigator L Mag Offset Dwr, dimensions: 60L x 48W	\$3,245.00	\$2,779.09
336320	TruckVault Inc.	T-LNNALS1-07M	Lincoln Navigator L Std 1 Dwr, dimensions: 52L x 48W	\$2,215.00	\$1,896.98
336320	TruckVault Inc.	T-LNNALS1-07S	Lincoln Navigator L Std 1 Dwr, dimensions: 28L x 48W	\$1,895.00	\$1,622.92

336320	TruckVault Inc.	T-LNNALS1-18S	Navigator L Std 1 Dwr	\$1,895.00	\$1,622.92
336320	TruckVault Inc.	T-LNNALS2-07F	Lincoln Navigator L Std 2 Dwr, dimensions: 61L x 48W	\$2,985.00	\$2,556.42
336320	TruckVault Inc.	T-LNNALS2-07F-PT	Lincoln Navigator L Std 2 Dwr, dimensions: 60L x 48W	\$3,685.00	\$3,155.92
336320	TruckVault Inc.	T-LNNALS2-07M	Lincoln Navigator L Std 2 Dwr, dimensions: 52L x 48W	\$2,755.00	\$2,359.45
336320	TruckVault Inc.	T-LNNALS2-18F	Navigator L Std 2 DwrMust Fold 3rd Seat	\$2,845.00	\$2,436.52
336320	TruckVault Inc.	T-LNNALS2-18S	Navigator L Std 2 Dwr	\$2,245.00	\$1,922.67
336320	TruckVault Inc.	T-LNNALSO-07F	Lincoln Navigator L Std OS Dwr, dimensions: 61L x 48W	\$2,985.00	\$2,556.42
336320	TruckVault Inc.	T-LNNALSO-07M	Lincoln Navigator L Std OS Dwr, dimensions: 52L x 48W	\$2,755.00	\$2,359.45
336320	TruckVault Inc.	T-LNNALSO-18F	Navigator L Std OS DwrMust Fold 3rd Seat	\$2,845.00	\$2,436.52
336320	TruckVault Inc.	T-LNNALU1-18S	Navigator L Utility 1 Dwr	\$1,995.00	\$1,708.56
336320	TruckVault Inc.	T-LNNALU2-03N-HT	Navigator Utility 2 Dwr HD Table	\$3,440.00	\$2,946.10
336320	TruckVault Inc.	T-LNNALU2-18N-TR	Navigator L Utility 2 Dwr	\$2,945.00	\$2,522.17
336320	TruckVault Inc.	T-LNNALU2-18S	Navigator L Utility 2 Dwr	\$2,545.00	\$2,179.60
336320	TruckVault Inc.	T-LNNAVM1-03N	Lincoln Navigator Mag 1 Dwr, dimensions: 45L x 48W	\$2,295.00	\$1,965.49
336320	TruckVault Inc.	T-LNNAVM1-96N-PA	Lincoln Navigator Mag 1 Dwr, dimensions: 42.5L x 48W	\$2,295.00	\$1,965.49
336320	TruckVault Inc.	T-LNNAVM2-03N	Lincoln Navigator Mag 2 Dwr, dimensions: 45L x 48W	\$2,845.00	\$2,436.52
336320	TruckVault Inc.	T-LNNAVM2-96N-PA	Lincoln Navigator Mag 2 Dwr, dimensions: 42.5L x 48W	\$2,845.00	\$2,436.52
336320	TruckVault Inc.	T-LNNAVML-96N	Lincoln Navigator Mag L Dwr, dimensions: 42.5L x 52W	\$2,225.00	\$1,905.54
336320	TruckVault Inc.	T-LNNAVMO-03N	Lincoln Navigator Mag OS Dwr, dimensions: 45L x 48W	\$2,845.00	\$2,436.52
336320	TruckVault Inc.	T-LNNAVMO-96N	Lincoln Navigator Mag OS Dwr, dimensions: 42.5L x 48W	\$2,845.00	\$2,436.52
336320	TruckVault Inc.	T-LNNAVMT-96N	Lincoln Navigator Mag T Dwr, dimensions: 42.5L x 56W	\$2,295.00	\$1,965.49
336320	TruckVault Inc.	T-LNNAVS1-03N	Lincoln Navigator Std 1 Dwr, dimensions: 47L x 48W	\$2,095.00	\$1,794.21
336320	TruckVault Inc.	T-LNNAVS1-96N-PA	Lincoln Navigator Std 1 Dwr, dimensions: 44L x 48W	\$2,095.00	\$1,794.21
336320	TruckVault Inc.	T-LNNAVS2-03N	Lincoln Navigator Std 2 Dwr, dimensions: 47L x 48W	\$2,645.00	\$2,265.24
336320	TruckVault Inc.	T-LNNAVS2-18N	Navigator Std 2 Dwr	\$2,645.00	\$2,265.24
336320	TruckVault Inc.	T-LNNAVS2-18N-TR	Navigator Std 2 Dwr	\$2,645.00	\$2,265.24
336320	TruckVault Inc.	T-LNNAVS2-96N	Lincoln Navigator Std 2 Dwr, dimensions: 44L x 48W	\$2,645.00	\$2,265.24
336320	TruckVault Inc.	T-LNNAVSL-96N	Lincoln Navigator Std L Dwr, dimensions: 44L x 52W	\$2,025.00	\$1,734.26
336320	TruckVault Inc.	T-LNNAVSO-03N	Lincoln Navigator Std OS Dwr, dimensions: 47L x 48W	\$2,645.00	\$2,265.24
336320	TruckVault Inc.	T-LNNAVSO-96N-PT	Lincoln Navigator Std OS Dwr, dimensions: 43L x 48W	\$3,340.00	\$2,860.45
336320	TruckVault Inc.	T-LNNAVST-96N	Lincoln Navigator Std T Dwr, dimensions: 44L x 56W	\$2,095.00	\$1,794.21
336320	TruckVault Inc.	T-LNNAVU1-18S	Navigator Utility 1 Dwr	\$1,995.00	\$1,708.56
336320	TruckVault Inc.	T-LNNAVU2-18S	Navigator Utility 2 Dwr	\$2,345.00	\$2,008.31
336320	TruckVault Inc.	T-LRDEFM1-07N	Land Rover Defender Mag 1 Drawer, dimensions: 0L x 0W	\$2,095.00	\$1,794.21
336320	TruckVault Inc.	T-LRDEFM1-90N	Defender Mag 1 Drawer	\$2,095.00	\$1,794.21
336320	TruckVault Inc.	T-LRDEFM2-07N	Land Rover Defender Mag 2 Drawer, dimensions: 0L x 0W	\$2,645.00	\$2,265.24
336320	TruckVault Inc.	T-LRDEFM2-90N	Defender Mag 2 Drawer	\$2,645.00	\$2,265.24
336320	TruckVault Inc.	T-LRDEFS1-07N	Land Rover Defender Std 1 Drawer, dimensions: 0L x 0W	\$1,895.00	\$1,622.92
336320	TruckVault Inc.	T-LRDEFS1-20N	Defender Std 1 Drawer	\$1,895.00	\$1,622.92
336320	TruckVault Inc.	T-LRDEFS1-90N	Land Rover Defender Std 1 Drawer, dimensions: 0L x 0W	\$1,895.00	\$1,622.92
336320	TruckVault Inc.	T-LRDEFS1-90N-HT	Defender Std 1 Drawer	\$2,520.00	\$2,158.19
336320	TruckVault Inc.	T-LRDEFS1-90N-ORV	Defender Std 1 Drawer	\$1,895.00	\$1,622.92
336320	TruckVault Inc.	T-LRDEFS2-07N	Land Rover Defender Std 2 Drawer, dimensions: 0L x 0W	\$2,445.00	\$2,093.95
336320	TruckVault Inc.	T-LRDEFS2-20N	Defender Std 2 Drawer	\$2,325.00	\$1,991.18
336320	TruckVault Inc.	T-LRDEFS2-90N	Land Rover Defender Std 2 Drawer, dimensions: 35.5L x 39W	\$2,445.00	\$2,093.95
336320	TruckVault Inc.	T-LRDEFSO-07N	Land Rover Defender Std OS Drawer, dimensions: 0L x 0W	\$2,445.00	\$2,093.95
336320	TruckVault Inc.	T-LRDEFSO-20N	Defender Std 2 Drawer Offset	\$2,325.00	\$1,991.18
336320	TruckVault Inc.	T-LRDEFU1-90N-HT	Defender Utility 1 Drawer	\$2,620.00	\$2,243.83
336320	TruckVault Inc.	T-LRDS1M1-94N	Land Rover Discovery I Mag 1 Dwr, dimensions: 25L x 40W	\$2,095.00	\$1,794.21
336320	TruckVault Inc.	T-LRDS1M2-94N	Land Rover Discovery I Mag 2 Dwr, dimensions: 25L x 40W	\$2,645.00	\$2,265.24
336320	TruckVault Inc.	T-LRDS1S1-94N	Land Rover Discovery I Std 1 Dwr, dimensions: 26L x 40W	\$1,895.00	\$1,622.92
336320	TruckVault Inc.	T-LRDS1S2-94N	Land Rover Discovery I Std 2 Dwr, dimensions: 26L x 40W	\$2,445.00	\$2,093.95
336320	TruckVault Inc.	T-LRDS2M1-98N	Land Rover Discovery II Mag 1 Dwr, dimensions: 30L x 38.5W	\$2,095.00	\$1,794.21
336320	TruckVault Inc.	T-LRDS2M1-98N-TR	Land Rover Discovery II Mag 1 Dwr, dimensions: 24L x 41.5W	\$2,095.00	\$1,794.21
336320	TruckVault Inc.	T-LRDS2M2-98N	Land Rover Discovery II Mag 2 Dwr, dimensions: 30L x 38.5W	\$2,645.00	\$2,265.24
336320	TruckVault Inc.	T-LRDS2S1-98N	Land Rover Discovery II Std 1 Dwr, dimensions: 30L x 38.5W	\$1,895.00	\$1,622.92
336320	TruckVault Inc.	T-LRDS2S2-98N	Land Rover Discovery II Std 2 Dwr, dimensions: 31L x 40W	\$2,445.00	\$2,093.95
336320	TruckVault Inc.	T-LRDS2SO-98N	Discovery II Std Offset Dwr	\$2,445.00	\$2,093.95
336320	TruckVault Inc.	T-LRDS2SO-98N-ZC9992	Discovery II Std Offset Dwr	\$2,185.00	\$1,871.28
336320	TruckVault Inc.	T-LRDS5S1-17N	LR5 Std 1 Dwr	\$2,095.00	\$1,794.21
336320	TruckVault Inc.	T-LRDS5S2-17N	LR5 Std 2 Dwr	\$2,645.00	\$2,265.24
336320	TruckVault Inc.	T-LRDS5U1-17N-TF	LR5 Utility 1 Dwr3rd seat folded	\$1,995.00	\$1,708.56
336320	TruckVault Inc.	T-LRDSSM1-14N	Discovery Sport Mag 1 Dwr	\$2,095.00	\$1,794.21
336320	TruckVault Inc.	T-LRDSSS2-14N	Discovery Sport Std 2 Dwr	\$2,445.00	\$2,093.95
336320	TruckVault Inc.	T-LRDSSU1-14N	Discovery Sport Utility 1 Dwr	\$1,925.00	\$1,648.61
336320	TruckVault Inc.	T-LRFREM1-96N	Land Rover Freelander Mag 1 Drawer, dimensions: 0L x 0W	\$2,225.00	\$1,905.54

336320	TruckVault Inc.	T-LRFREM2-96N	Land Rover Freelander Mag 2 Drawer, dimensions: 0L x 0W	\$2,725.00	\$2,333.75
336320	TruckVault Inc.	T-LRFRES1-96N	Land Rover Freelander Std 1 Drawer, dimensions: 0L x 0W	\$2,025.00	\$1,734.26
336320	TruckVault Inc.	T-LRFRES2-96N	Land Rover Freelander Std 2 Drawer, dimensions: 0L x 0W	\$2,525.00	\$2,162.47
336320	TruckVault Inc.	T-LRLR2M1-07N	Land Rover LR2 Mag 1 Dwr, dimensions: 26.5L x 38W	\$2,095.00	\$1,794.21
336320	TruckVault Inc.	T-LRLR2M2-07N	Land Rover LR2 Mag 2 Dwr, dimensions: 0L x 0W	\$2,645.00	\$2,265.24
336320	TruckVault Inc.	T-LRLR2S1-07N	Land Rover LR2 Std 1 Dwr, dimensions: 38.5L x 40W	\$2,095.00	\$1,794.21
336320	TruckVault Inc.	T-LRLR2S2-07N	Land Rover LR2 Std 2 Dwr, dimensions: 26L x 38.5W	\$2,445.00	\$2,093.95
336320	TruckVault Inc.	T-LRLR3M1-05N	Land Rover LR3 Mag 1 Dwr, dimensions: 36.5L x 40W	\$2,295.00	\$1,965.49
336320	TruckVault Inc.	T-LRLR3M1-05N-PT	Land Rover LR3 Mag 1 Dwr, dimensions: 36.5L x 40W	\$2,990.00	\$2,560.71
336320	TruckVault Inc.	T-LRLR3M2-05N	Land Rover LR3 Mag 2 Dwr, dimensions: 36.5L x 40W	\$2,845.00	\$2,436.52
336320	TruckVault Inc.	T-LRLR3S1-05N	Land Rover LR3 Std 1 Dwr, dimensions: 38.5L x 40W	\$2,095.00	\$1,794.21
336320	TruckVault Inc.	T-LRLR3S2-05N	Land Rover LR3 Std 2 Dwr, dimensions: 38.5L x 40W	\$2,645.00	\$2,265.24
336320	TruckVault Inc.	T-LRLR3SO-05N	Land Rover LR3 Std OS Dwr, dimensions: 38.5L x 40W	\$2,645.00	\$2,265.24
336320	TruckVault Inc.	T-LRLR3UO-05N	LR3 Utility OS Dwr	\$2,745.00	\$2,350.88
336320	TruckVault Inc.	T-LRLR4M1-11N	Land Rover LR4 Mag 1 Dwr, dimensions: 36L x 41W	\$2,295.00	\$1,965.49
336320	TruckVault Inc.	T-LRLR4MO-11N	LR4 Mag 2 Dwr Offset	\$2,845.00	\$2,436.52
336320	TruckVault Inc.	T-LRLR4S1-11N	Land Rover LR4 Std 1 Dwr, dimensions: 38L x 41W	\$2,095.00	\$1,794.21
336320	TruckVault Inc.	T-LRLR4S2-11N	Land Rover LR4 Std 2 Dwr, dimensions: 38L x 41W	\$2,645.00	\$2,265.24
336320	TruckVault Inc.	T-LRLR4U1-11N	LR4 Utility 1 Dwr	\$2,195.00	\$1,879.85
336320	TruckVault Inc.	T-LRRROM1-03N	Land Rover Range Rover Mag 1 Dwr, dimensions: 34L x 41W	\$2,095.00	\$1,794.21
336320	TruckVault Inc.	T-LRRROM1-03N-PT	Land Rover Range Rover Mag 1 Dwr, dimensions: 33L x 41W	\$2,790.00	\$2,389.42
336320	TruckVault Inc.	T-LRRROM1-13N	Land Rover Range Rover Mag 1 Dwr, dimensions: 31L x 40W	\$2,095.00	\$1,794.21
336320	TruckVault Inc.	T-LRRROM1-13N-ZC10496	Range Rover Mag 1 Dwr CustomC10496	\$2,115.00	\$1,811.34
336320	TruckVault Inc.	T-LRRROM1-90N	Land Rover Range Rover Mag 1 Dwr, dimensions: 1L x 1W	\$2,095.00	\$1,794.21
336320	TruckVault Inc.	T-LRRROM1-95N	Land Rover Range Rover Mag 1 Dwr, dimensions: 32L x 41.5W	\$2,095.00	\$1,794.21
336320	TruckVault Inc.	T-LRRROM2-03N	Land Rover Range Rover Mag 2 Dwr, dimensions: 34L x 41W	\$2,645.00	\$2,265.24
336320	TruckVault Inc.	T-LRRROM2-95N	Land Rover Range Rover Mag 2 Dwr, dimensions: 32L x 41.5W	\$2,645.00	\$2,265.24
336320	TruckVault Inc.	T-LRRROMO-03N	Land Rover Range Rover Mag Offset Dwr, dimensions: 34L x 41W	\$2,645.00	\$2,265.24
336320	TruckVault Inc.	T-LRRROMO-03N-PT	Land Rover Range Rover Mag Offset Dwr, dimensions: 33L x 41W	\$3,340.00	\$2,860.45
336320	TruckVault Inc.	T-LRRROS1-03N	Land Rover Range Rover Std 1 Dwr, dimensions: 36.5L x 41W	\$2,095.00	\$1,794.21
336320	TruckVault Inc.	T-LRRROS1-13N	Land Rover Range Rover Std 1 Dwr, dimensions: 34L x 40W	\$1,895.00	\$1,622.92
336320	TruckVault Inc.	T-LRRROS1-13N-PT	Land Rover Range Rover Std 1 Dwr, dimensions: 38L x 41W	\$2,790.00	\$2,389.42
336320	TruckVault Inc.	T-LRRROS1-95N	Land Rover Range Rover Std 1 Dwr, dimensions: 32.75L x 41.5W	\$1,895.00	\$1,622.92
336320	TruckVault Inc.	T-LRRROS2-03N	Land Rover Range Rover Std 2 Dwr, dimensions: 36.5L x 41W	\$2,645.00	\$2,265.24
336320	TruckVault Inc.	T-LRRROS2-13N	Land Rover Range Rover Std 2 Dwr, dimensions: 34L x 40W	\$2,445.00	\$2,093.95
336320	TruckVault Inc.	T-LRRROS2-95N	Land Rover Range Rover Std 2 Dwr, dimensions: 32.75L x 41.5W	\$2,445.00	\$2,093.95
336320	TruckVault Inc.	T-LRRROSO-03N	Land Rover Range Rover Std OS Dwr, dimensions: 36.5L x 41W	\$2,645.00	\$2,265.24
336320	TruckVault Inc.	T-LRRROSO-13N	Range Rover Std OS Dwr	\$2,445.00	\$2,093.95
336320	TruckVault Inc.	T-LRRROU1-13N	Range Rover Utility 1 Dwr	\$1,995.00	\$1,708.56
336320	TruckVault Inc.	T-LRRRSM1-06N	Land Rover Range Rover Sport Mag 1 Dwr, dimensions: 32L x 40W	\$2,095.00	\$1,794.21
336320	TruckVault Inc.	T-LRRRSM1-14N	Land Rover Range Rover Sport Mag 1 Dwr, dimensions: 32L x 40W	\$2,095.00	\$1,794.21
336320	TruckVault Inc.	T-LRRRSM2-14N-HT	Range Rover Sport Std 2 Dwr	\$3,340.00	\$2,860.45
336320	TruckVault Inc.	T-LRRRSMO-14N	Land Rover Range Rover Sport Mag OS Dwr, dimensions: 32L x 40W	\$2,645.00	\$2,265.24
336320	TruckVault Inc.	T-LRRRSN1-14N-ZC9516	Range Rover Sport Custom 1 Dwr	\$2,135.00	\$1,828.46
336320	TruckVault Inc.	T-LRRRSN2-06N-ZC10804	Range Rover Sport Std 2 DwrC10804	\$2,285.00	\$1,956.93
336320	TruckVault Inc.	T-LRRRSN2-13N-ZC10804	Range Rover Sport Std 2 DwrC10804	\$2,285.00	\$1,956.93
336320	TruckVault Inc.	T-LRRRSS1-06N	Land Rover Range Rover Sport Std 1 Dwr, dimensions: 34L x 39W	\$1,895.00	\$1,622.92
336320	TruckVault Inc.	T-LRRRSS1-14N	Land Rover Range Rover Sport Std 1 Dwr, dimensions: 34L x 40W	\$1,895.00	\$1,622.92
336320	TruckVault Inc.	T-LRRRSS1-14N-PT	Range Rover Sport Std 1 DwrTable Extension	\$2,590.00	\$2,218.14
336320	TruckVault Inc.	T-LRRRSS2-06N	Land Rover Range Rover Sport Std 2 Dwr, dimensions: 34L x 39W	\$2,445.00	\$2,093.95
336320	TruckVault Inc.	T-LRRRSS2-14N	Land Rover Range Rover Sport Std 2 Dwr, dimensions: 35L x 39W	\$2,215.00	\$1,896.98
336320	TruckVault Inc.	T-LRRRSSO-06N	Land Rover Range Rover Sport Std OS Dwr, dimensions: 34L x 39W	\$2,445.00	\$2,093.95
336320	TruckVault Inc.	T-LRRRSSO-14N	Range Rover Sport Std OS Dwr	\$2,445.00	\$2,093.95
336320	TruckVault Inc.	T-LRRRSU1-14N	Range Rover Sport Utility 1 Dwr	\$1,995.00	\$1,708.56
336320	TruckVault Inc.	T-LRRRSU2-14N	Range Rover Sport Utility 2 Dwr	\$2,545.00	\$2,179.60
336320	TruckVault Inc.	T-LRRRSUO-14N	Range Rover Sport Utility OS Dwr	\$2,545.00	\$2,179.60

336320	TruckVault Inc.	T-LX450M1-91N	Lexus LX450 Mag 1 Dwr, dimensions: 0L x 0W	\$2,295.00	\$1,965.49
336320	TruckVault Inc.	T-LX450M2-91N	Lexus LX450 Mag 2 Dwr, dimensions: 0L x 0W	\$2,845.00	\$2,436.52
336320	TruckVault Inc.	T-LX450S1-91N	Lexus LX450 Std 1 Dwr, dimensions: 42L x 43W	\$2,095.00	\$1,794.21
336320	TruckVault Inc.	T-LX450S2-04N	Lexus LX450 Std 2 Dwr, dimensions: 0L x 0W	\$2,645.00	\$2,265.24
336320	TruckVault Inc.	T-LX450S2-91N	Lexus LX450 Std 2 Dwr, dimensions: 42L x 43W	\$2,645.00	\$2,265.24
336320	TruckVault Inc.	T-LX470S1-99N-TR-HD	GX470 Std 1 Dwr 1/2 W Driverside	\$1,625.00	\$1,391.69
336320	TruckVault Inc.	T-LX470U1-99N-HT	LX470 Utility 1 Dwr HD Table	\$2,890.00	\$2,475.06
336320	TruckVault Inc.	T-LXCT2U1-11N	CT200H Utility 1 Dwr	\$1,795.00	\$1,537.28
336320	TruckVault Inc.	T-LXG46M1-10N	Lexus GX460 Mag 1 Dwr, dimensions: 31L x 42W	\$2,095.00	\$1,794.21
336320	TruckVault Inc.	T-LXG46M1-10N-C1-HP-ZC10448	GX460 Mag 1 DwrC10448	\$3,335.00	\$2,856.17
336320	TruckVault Inc.	T-LXG46M2-10N	GX460 Mag 2 Dwr	\$2,645.00	\$2,265.24
336320	TruckVault Inc.	T-LXG46MO-10N	GX460 Mag 2 Dwr Offset	\$2,525.00	\$2,162.47
336320	TruckVault Inc.	T-LXG46MO-10N-HT	GX460 Mag 2 Dwr Offset	\$3,220.00	\$2,757.68
336320	TruckVault Inc.	T-LXG46S1-10N	Lexus GX460 Std 1 Dwr, dimensions: 34L x 43W	\$1,895.00	\$1,622.92
336320	TruckVault Inc.	T-LXG46S1-10N-HN	GX460 Std 1 Dwr1/2 Width	\$1,695.00	\$1,451.64
336320	TruckVault Inc.	T-LXG46S2-10N	Lexus GX460 Std 2 Dwr, dimensions: 34L x 43W	\$2,445.00	\$2,093.95
336320	TruckVault Inc.	T-LXG46SO-10N	GX460 Std OS Dwr	\$2,445.00	\$2,093.95
336320	TruckVault Inc.	T-LXG46U1-10N	GX460 Utility 1 Dwr	\$1,995.00	\$1,708.56
336320	TruckVault Inc.	T-LXG46U1-10N-HN	GX460 Utility 1 Dwr1/2 Width	\$1,795.00	\$1,537.28
336320	TruckVault Inc.	T-LXG46U2-03N	GX460 Utility 2 Dwr	\$2,545.00	\$2,179.60
336320	TruckVault Inc.	T-LXG46U2-10N	GX460 Utility 2 Dwr	\$2,545.00	\$2,179.60
336320	TruckVault Inc.	T-LXG46UO-10N	GX460 Utility OS Dwr	\$2,545.00	\$2,179.60
336320	TruckVault Inc.	T-LXG47M1-03N	Lexus GX470 Mag 1 Dwr, dimensions: 36L x 41W	\$2,295.00	\$1,965.49
336320	TruckVault Inc.	T-LXG47M2-03N	Lexus GX470 Mag 2 Dwr, dimensions: 34L x 41W	\$2,645.00	\$2,265.24
336320	TruckVault Inc.	T-LXG47S1-03N	Lexus GX470 Std 1 Dwr, dimensions: 36L x 41W	\$2,095.00	\$1,794.21
336320	TruckVault Inc.	T-LXG47S1-03N-TR	GX470 Std 1 Dwr	\$1,895.00	\$1,622.92
336320	TruckVault Inc.	T-LXG47S1-10N-TR	GX470 Std 1 Dwr	\$1,895.00	\$1,622.92
336320	TruckVault Inc.	T-LXG47S2-03N	Lexus GX470 Std 2 Dwr, dimensions: 36L x 41W	\$2,645.00	\$2,265.24
336320	TruckVault Inc.	T-LXG47S2-03N-TR	GX470 Std 2 Dwr	\$2,445.00	\$2,093.95
336320	TruckVault Inc.	T-LXL45S2-91N	Lexus LX450 Std 2 Dwr, dimensions: 36L x 41W	\$2,645.00	\$2,265.24
336320	TruckVault Inc.	T-LXL47M1-04N	Lexus LX470 Mag 1 Dwr, dimensions: 40.5L x 42.5W	\$2,295.00	\$1,965.49
336320	TruckVault Inc.	T-LXL47M1-99N	Lexus LX470 Mag 1 Dwr, dimensions: 38.5L x 42W	\$2,295.00	\$1,965.49
336320	TruckVault Inc.	T-LXL47M2-04N	Lexus LX470 Mag 2 Dwr, dimensions: 40.5L x 42.5W	\$2,845.00	\$2,436.52
336320	TruckVault Inc.	T-LXL47M2-91N	Lexus LX470 Mag 2 Dwr, dimensions: 0L x 0W	\$2,845.00	\$2,436.52
336320	TruckVault Inc.	T-LXL47M2-99N	Lexus LX470 Mag 2 Dwr, dimensions: 38.5L x 42W	\$2,845.00	\$2,436.52
336320	TruckVault Inc.	T-LXL47MO-04N	Lexus LX470 Mag OS Dwr, dimensions: 38.5L x 43.25W	\$2,845.00	\$2,436.52
336320	TruckVault Inc.	T-LXL47MO-99N	Lexus LX470 Mag OS Dwr, dimensions: 38.5L x 42W	\$2,845.00	\$2,436.52
336320	TruckVault Inc.	T-LXL47S1-04N	Lexus LX470 Std 1 Dwr, dimensions: 41.5L x 42.5W	\$2,095.00	\$1,794.21
336320	TruckVault Inc.	T-LXL47S1-99N	Lexus LX470 Std 1 Dwr, dimensions: 40.5L x 42W	\$2,095.00	\$1,794.21
336320	TruckVault Inc.	T-LXL47S2-04N	Lexus LX470 Std 2 Dwr, dimensions: 41.5L x 42.5W	\$2,645.00	\$2,265.24
336320	TruckVault Inc.	T-LXL47S2-99N	Lexus LX470 Std 2 Dwr, dimensions: 40.5L x 42W	\$2,645.00	\$2,265.24
336320	TruckVault Inc.	T-LXL47SO-04N	Lexus LX470 Std OS Dwr, dimensions: 41.5L x 42.5W	\$2,645.00	\$2,265.24
336320	TruckVault Inc.	T-LXL47SO-99N	Lexus LX470 Std 2 Dwr, dimensions: 40.5L x 42W	\$2,645.00	\$2,265.24
336320	TruckVault Inc.	T-LXL47SO-99N	Lexus LX470 Std 2 Dwr, dimensions: 40.5L x 42W	\$2,645.00	\$2,265.24
336320	TruckVault Inc.	T-LXL47SO-99N-PT	Lexus LX470 Std 2 Dwr Table Ext, dimensions: 40.5L x 42W	\$3,340.00	\$2,860.45
336320	TruckVault Inc.	T-LXL57M1-08N	LX570 Mag 1 Dwr	\$2,295.00	\$1,965.49
336320	TruckVault Inc.	T-LXL57M1-08N-TR	Lexus LX570 Mag 1 Dwr, dimensions: 39L x 40W	\$2,295.00	\$1,965.49
336320	TruckVault Inc.	T-LXL57M2-08N	LX570 Mag 2 Dwr	\$2,845.00	\$2,436.52
336320	TruckVault Inc.	T-LXL57M2-08N-TR	Lexus LX570 Mag 2 Dwr, dimensions: 40L x 39W	\$2,845.00	\$2,436.52
336320	TruckVault Inc.	T-LXL57MO-08N-TR	LX570 Mag OS Dwr	\$2,845.00	\$2,436.52
336320	TruckVault Inc.	T-LXL57S1-08N	LX570 Std 1 Dwr	\$2,095.00	\$1,794.21
336320	TruckVault Inc.	T-LXL57S1-08N-HP	LX570 Std 1 Dwr Half Width	\$1,695.00	\$1,451.64
336320	TruckVault Inc.	T-LXL57S1-08N-HP-TR	LX570 Std 1 Dwr Half Width	\$1,695.00	\$1,451.64
336320	TruckVault Inc.	T-LXL57S1-08N-HT-TR	LX570 Std 1 Dwr	\$2,790.00	\$2,389.42
336320	TruckVault Inc.	T-LXL57S1-08N-NT	LX570 Std 1 DwrNever Had 3rd Row Seat	\$2,095.00	\$1,794.21
336320	TruckVault Inc.	T-LXL57S1-08N-TR	Lexus LX570 Std 1 Dwr, dimensions: 40L x 38W	\$2,095.00	\$1,794.21
336320	TruckVault Inc.	T-LXL57S1-08N-TR-HT	LX570 Std 1 Dwr	\$2,790.00	\$2,389.42
336320	TruckVault Inc.	T-LXL57S2-08N	LX570 Std 2 Dwr	\$2,645.00	\$2,265.24
336320	TruckVault Inc.	T-LXL57S2-08N-TR	Lexus LX570 Std 2 Dwr, dimensions: 40L x 40W	\$2,645.00	\$2,265.24
336320	TruckVault Inc.	T-LXL57U1-08N-TR	LX570 Utility 1 Dwr	\$2,195.00	\$1,879.85
336320	TruckVault Inc.	T-LXL57U2-08N	LX570 Utility 2 Dwr	\$2,745.00	\$2,350.88
336320	TruckVault Inc.	T-LXL57UO-08N	LX570 Utility OS Dwr	\$2,745.00	\$2,350.88
336320	TruckVault Inc.	T-LXNXTNS1-15N	NX Std 1 Dwr	\$1,825.00	\$1,562.97
336320	TruckVault Inc.	T-LXRNM1-04N	Lexus RX Mag 1 Dwr, dimensions: 0L x 0W	\$2,095.00	\$1,794.21
336320	TruckVault Inc.	T-LXRNM1-10N	Lexus RX Mag 1 Dwr, dimensions: 31L x 42W	\$2,095.00	\$1,794.21
336320	TruckVault Inc.	T-LXRNM1-16N-PH	RX Mag 1 Dwr	\$2,095.00	\$1,794.21



336320	TruckVault Inc.	T-LXRNXM2-04N	Lexus RX Mag 2 Dwr, dimensions: 0L x 0W	\$2,645.00	\$2,265.24
336320	TruckVault Inc.	T-LXRNXM2-10N	Lexus RX Mag 2 Dwr, dimensions: 0L x 0W	\$2,645.00	\$2,265.24
336320	TruckVault Inc.	T-LXRNXMO-16N-PH	RX Mag OS Dwr	\$2,645.00	\$2,265.24
336320	TruckVault Inc.	T-LXRXNS1-04N	Lexus RX Std 1 Dwr, dimensions: 0L x 0W	\$1,895.00	\$1,622.92
336320	TruckVault Inc.	T-LXRXNS1-10N	Lexus RX Std 1 Dwr, dimensions: 33L x 42W	\$1,895.00	\$1,622.92
336320	TruckVault Inc.	T-LXRXNS2-04N	Lexus RX Std 2 Dwr, dimensions: 31L x 38W	\$2,445.00	\$2,093.95
336320	TruckVault Inc.	T-LXRXNS2-10N	Lexus RX Std 2 Dwr, dimensions: 27L x 48W	\$2,445.00	\$2,093.95
336320	TruckVault Inc.	T-LXRXNU2-16N	RX Utility 2 Dwr	\$2,545.00	\$2,179.60
336320	TruckVault Inc.	T-LXUX25S1-19N	UX 250H Std 1 Dwr	\$1,625.00	\$1,391.69
336320	TruckVault Inc.	T-LXUX25S1-19N-HT	UX 250H Std 1 Dwr	\$2,320.00	\$1,986.90
336320	TruckVault Inc.	T-MBENDM1-03N	Mitsubishi Endeavor Mag 1 Dwr, dimensions: 0L x 0W	\$2,095.00	\$1,794.21
336320	TruckVault Inc.	T-MBENDM2-03N	Mitsubishi Endeavor Mag 2 Dwr, dimensions: 0L x 0W	\$2,645.00	\$2,265.24
336320	TruckVault Inc.	T-MBENDS1-03N	Mitsubishi Endeavor Std 1 Dwr, dimensions: 37.5L x 38W	\$2,095.00	\$1,794.21
336320	TruckVault Inc.	T-MBENDS2-03N	Mitsubishi Endeavor Std 2 Dwr, dimensions: 37.5L x 38W	\$2,645.00	\$2,265.24
336320	TruckVault Inc.	T-MBMSPM1-97N	Mitsubishi Montero Sport Mag 1 Dwr, dimensions: 0L x 0W	\$2,095.00	\$1,794.21
336320	TruckVault Inc.	T-MBMSPM2-97N	Mitsubishi Montero Sport Mag 2 Dwr, dimensions: 0L x 0W	\$2,645.00	\$2,265.24
336320	TruckVault Inc.	T-MBMSPS1-97N	Mitsubishi Montero Sport Std 1 Dwr, dimensions: 37L x 38W	\$2,095.00	\$1,794.21
336320	TruckVault Inc.	T-MBMSPS2-97N	Mitsubishi Montero Sport Std 2 Dwr, dimensions: 38L x 37W	\$2,645.00	\$2,265.24
336320	TruckVault Inc.	T-MBMSPSO-97N	Montero Sport Std 2 Dwr	\$2,645.00	\$2,265.24
336320	TruckVault Inc.	T-MBOUTM1-03N	Mitsubishi Outlander Mag 1 Dwr, dimensions: 0L x 0W	\$2,095.00	\$1,794.21
336320	TruckVault Inc.	T-MBOUTM1-14N	Mitsubishi Outlander Mag 1 Dwr, dimensions: 30L x 38W	\$2,095.00	\$1,794.21
336320	TruckVault Inc.	T-MBOUTM2-03N	Mitsubishi Outlander Mag 2 Dwr, dimensions: 33L x 36W	\$2,645.00	\$2,265.24
336320	TruckVault Inc.	T-MBOUTMO-14N	Mitsubishi Outlander Mag Offset Dwr, dimensions: 30L x 38W	\$2,645.00	\$2,265.24
336320	TruckVault Inc.	T-MBOUTS1-03N	Mitsubishi Outlander Std 1 Dwr, dimensions: 0L x 0W	\$1,895.00	\$1,622.92
336320	TruckVault Inc.	T-MBOUTS1-14N	Outlander Std 1 Dwr	\$1,895.00	\$1,622.92
336320	TruckVault Inc.	T-MBOUTS2-03N	Mitsubishi Outlander Std 2 Dwr, dimensions: 0L x 0W	\$2,445.00	\$2,093.95
336320	TruckVault Inc.	T-MBOUTS2-14N-PP	Mitsubishi Outlander Std 2 Dwr, dimensions: 29L x 38W	\$2,445.00	\$2,093.95
336320	TruckVault Inc.	T-MC4DHM1-15N	Mini Cooper 4 Door Hardtop Mag 1 Dwr	\$1,695.00	\$1,451.64
336320	TruckVault Inc.	T-MC4DHS1-15N	Mini Cooper 4 Door Hardtop Std 1 Dwr	\$1,495.00	\$1,280.35
336320	TruckVault Inc.	T-MCCTRM1-10N	Mini Cooper Countryman Mag 1 Dwr	\$1,895.00	\$1,622.92
336320	TruckVault Inc.	T-MCCTRS1-10N	Mini Cooper Countryman Std 1 Dwr	\$1,695.00	\$1,451.64
336320	TruckVault Inc.	T-MDG50M1-05N	Mercedes G-Class Mag 1 Dwr, dimensions: 31L x 36W	\$2,095.00	\$1,794.21
336320	TruckVault Inc.	T-MDG50M1-18N	G-Class Mag 1 Dwr	\$2,095.00	\$1,794.21
336320	TruckVault Inc.	T-MDG50M1-19N-ZC10071	G-Class Mag 1 Dwr	\$1,975.00	\$1,691.44
336320	TruckVault Inc.	T-MDG50M2-05N	G-Class Mag 2 Dwr	\$2,645.00	\$2,265.24
336320	TruckVault Inc.	T-MDG50S1-05N	Mercedes G-Class Std 1 Dwr, dimensions: 33L x 36W	\$1,895.00	\$1,622.92
336320	TruckVault Inc.	T-MDG50S1-18N	G-Class Std 1 Dwr	\$1,895.00	\$1,622.92
336320	TruckVault Inc.	T-MDG50S1-19N	G-Class Std 1 Dwr	\$1,895.00	\$1,622.92
336320	TruckVault Inc.	T-MDG50S2-05N	G-class Std 2 Dwr	\$2,445.00	\$2,093.95
336320	TruckVault Inc.	T-MDG50S2-19N	G-Class Std 2 Dwr	\$2,445.00	\$2,093.95
336320	TruckVault Inc.	T-MDG50SO-05N	G-Class Std OS Dwr	\$2,445.00	\$2,093.95
336320	TruckVault Inc.	T-MDG50SO-05N-ZC8701	G-Class Std OS Dwr	\$2,585.00	\$2,213.85
336320	TruckVault Inc.	T-MDG50U1-05N	G-Class Utility 1 Dwr	\$1,995.00	\$1,708.56
336320	TruckVault Inc.	T-MDG50U1-19N	G-Class Std 1 Dwr	\$1,965.00	\$1,682.87
336320	TruckVault Inc.	T-MDG50U2-05N	G-Class Utility 2 Dwr	\$2,545.00	\$2,179.60
336320	TruckVault Inc.	T-MDG50UO-19N	G-Class Utility 2 Dwr Offset	\$2,545.00	\$2,179.60
336320	TruckVault Inc.	T-MDGL2M1-14N	Outlander Mag Offset Dwr	\$1,895.00	\$1,622.92
336320	TruckVault Inc.	T-MDGL2S1-14N	Mercedes 250 GLA Std 1 Dwr, dimensions: 22L x 38W	\$1,695.00	\$1,451.64
336320	TruckVault Inc.	T-MDGL3M1-06N	GL350 Mag 1 Dwr	\$2,295.00	\$1,965.49
336320	TruckVault Inc.	T-MDGL3M2-06N	GL350 Mag 2 Dwr	\$2,845.00	\$2,436.52
336320	TruckVault Inc.	T-MDGL3S1-06N	Mercedes GL350 Std 1 Dwr, dimensions: 46L x 39W	\$2,095.00	\$1,794.21
336320	TruckVault Inc.	T-MDGL3S1-11N	GLE300 Std 1 Dwr	\$1,895.00	\$1,622.92
336320	TruckVault Inc.	T-MDGL3S2-06N	Mercedes GL350 Std 2 Dwr, dimensions: 46L x 39W	\$2,645.00	\$2,265.24
336320	TruckVault Inc.	T-MDGL3U2-13N-HT	GL350 Utility 2 DwrHeavy Duty Table	\$3,440.00	\$2,946.10
336320	TruckVault Inc.	T-MDGL4M1-06N	Mercedes GL-class Mag 1 Dwr, dimensions: 40L x 40W	\$2,295.00	\$1,965.49
336320	TruckVault Inc.	T-MDGL4M1-13N	GL-class Mag 1 Dwr	\$2,095.00	\$1,794.21
336320	TruckVault Inc.	T-MDGL4M1-13N-HT	GL-class Mag1 Dwr	\$2,790.00	\$2,389.42
336320	TruckVault Inc.	T-MDGL4M1-20N-HT	GL-class Mag1 Dwr	\$2,790.00	\$2,389.42
336320	TruckVault Inc.	T-MDGL4M2-06N	Mercedes GL-class Mag 2 Dwr, dimensions: 42L x 40W	\$2,845.00	\$2,436.52
336320	TruckVault Inc.	T-MDGL4M2-13N	GL-class Mag 2 Dwr	\$2,645.00	\$2,265.24
336320	TruckVault Inc.	T-MDGL4MO-06N	Mercedes GL-class Mag Offset, dimensions: 42L x 40W	\$2,845.00	\$2,436.52
336320	TruckVault Inc.	T-MDGL4S1-06N	Mercedes GL-class Std 1 Dwr, dimensions: 46L x 39W	\$2,095.00	\$1,794.21
336320	TruckVault Inc.	T-MDGL4S1-13N	GL-class Std 1 Dwr	\$1,895.00	\$1,622.92
336320	TruckVault Inc.	T-MDGL4S2-06N	Mercedes GL-class Std 2 Dwr, dimensions: 46L x 39W	\$2,645.00	\$2,265.24
336320	TruckVault Inc.	T-MDGL4S2-13N	GL-class Std 2 Dwr	\$2,445.00	\$2,093.95
336320	TruckVault Inc.	T-MDGL4SO-06N	Mercedes GL-class Std Offset Dwr, dimensions: 46L x 39W	\$2,645.00	\$2,265.24

336320	TruckVault Inc.	T-MDGL5S1-05N	Mercedes G-Class Std 1 Dwr, dimensions: 33L x 36W	\$1,895.00	\$1,622.92
336320	TruckVault Inc.	T-MDGLKS1-10N	GLK Std 1 Dwr	\$1,895.00	\$1,622.92
336320	TruckVault Inc.	T-MDGLSM1-20N-HT	GLS-class Mag 1 Dwr	\$2,990.00	\$2,560.71
336320	TruckVault Inc.	T-MDGLSM1-20N-HT-ZC11492	GLS-class Mag 1 Dwr	\$3,055.00	\$2,616.37
336320	TruckVault Inc.	T-MDGLSS1-16N	GLS-class Std 1 Dwr	\$2,095.00	\$1,794.21
336320	TruckVault Inc.	T-MDGLSS1-20N	GLS-class Std 1 Dwr	\$2,095.00	\$1,794.21
336320	TruckVault Inc.	T-MDGLSS1-20N-PT	GLS-class Std 1 Dwr	\$2,790.00	\$2,389.42
336320	TruckVault Inc.	T-MDGLSS2-16N	GLS-class Std 2 Dwr	\$2,645.00	\$2,265.24
336320	TruckVault Inc.	T-MDGLSS2-20N	GLS-class Std 2 Dwr	\$2,645.00	\$2,265.24
336320	TruckVault Inc.	T-MDGLSS2-20N-PT	GLS-class Std 2 Dwr	\$3,340.00	\$2,860.45
336320	TruckVault Inc.	T-MDGLSU2-16N	GLS-class Utility 2 Dwr	\$2,745.00	\$2,350.88
336320	TruckVault Inc.	T-MDMCLM1-98N	Mercedes M-class Mag 1 Dwr, dimensions: 33L x 44W	\$2,095.00	\$1,794.21
336320	TruckVault Inc.	T-MDMCLM2-98N	Mercedes M-class Mag 2 Dwr, dimensions: 33L x 44W	\$2,645.00	\$2,265.24
336320	TruckVault Inc.	T-MDMCLS1-00N	Mercedes M-class Std 1 Dwr, dimensions: 33L x 43.5W	\$1,895.00	\$1,622.92
336320	TruckVault Inc.	T-MDMCLS1-06N	Mercedes M-class Std 1 Dwr, dimensions: 35L x 38.5W	\$1,895.00	\$1,622.92
336320	TruckVault Inc.	T-MDMCLS1-12N	Mercedes M-class Std 1 Dwr, dimensions: 32L x 40W	\$1,895.00	\$1,622.92
336320	TruckVault Inc.	T-MDMCLS1-98N	Mercedes M-class Std 1 Dwr, dimensions: 33L x 44W	\$1,895.00	\$1,622.92
336320	TruckVault Inc.	T-MDMCLS2-11N	Mercedes M-class Std 2 Dwr, dimensions: 34L x 40W	\$2,445.00	\$2,093.95
336320	TruckVault Inc.	T-MDMCLS2-98N	Mercedes M-class Std 2 Dwr, dimensions: 33L x 44W	\$2,445.00	\$2,093.95
336320	TruckVault Inc.	T-MDMDXM1-98N-HT	ML Mag 1 Dwr	\$2,790.00	\$2,389.42
336320	TruckVault Inc.	T-MDMDXM2-98N	Mercedes ML Mag 2 Dwr, dimensions: 62L x 44W	\$2,985.00	\$2,556.42
336320	TruckVault Inc.	T-MDMDXS1-98N	Mercedes ML Std 1 Dwr, dimensions: 36L x 40.5W	\$2,095.00	\$1,794.21
336320	TruckVault Inc.	T-MDMDXS2-98N	Mercedes ML Std 2 Dwr, dimensions: 36L x 40W	\$2,645.00	\$2,265.24
336320	TruckVault Inc.	T-MDMLXMO-06N	ML63/550 Mag OS Dwr	\$2,645.00	\$2,265.24
336320	TruckVault Inc.	T-MDMLXS1-06N	Mercedes ML63 Std 1 Dwr, dimensions: 35L x 38.5W	\$1,895.00	\$1,622.92
336320	TruckVault Inc.	T-MDMLXS1-06N-ORV	ML63 Std 1 Dwr	\$1,895.00	\$1,622.92
336320	TruckVault Inc.	T-MDMLXS2-06N	Mercedes ML63 Std 2 Dwr, dimensions: 35L x 38.5W	\$2,445.00	\$2,093.95
336320	TruckVault Inc.	T-MDMTSM2-16F	Metris Mag 2 Dwr	\$3,045.00	\$2,607.81
336320	TruckVault Inc.	T-MDMTSMO-16N	Metris Mag OS Dwr	\$3,645.00	\$3,121.66
336320	TruckVault Inc.	T-MDMTSN1-16N-ZC8736	Metris Cust 1 Dwr	\$1,685.00	\$1,443.07
336320	TruckVault Inc.	T-MDMTSS1-16F	Metris Std 1 Dwr	\$2,295.00	\$1,965.49
336320	TruckVault Inc.	T-MDMTSSO-16F	Metris Std OS Dwr	\$2,845.00	\$2,436.52
336320	TruckVault Inc.	T-MDSPRM1-19N-ZC10385A	Sprinter Mag 1 Dwr CustomC10385A	\$2,375.00	\$2,034.01
336320	TruckVault Inc.	T-MDSPRM2-06F-ZC11614	Sprinter Magnum 2 Drawer Custom	\$3,125.00	\$2,676.32
336320	TruckVault Inc.	T-MDSPRM2-06M	Sprinter Mag 2 Dwr	\$3,645.00	\$3,121.66
336320	TruckVault Inc.	T-MDSPRM2-06N	Sprinter Mag 2 Dwr	\$3,045.00	\$2,607.81
336320	TruckVault Inc.	T-MDSPRM2-06N-HT-TT-ZC10776B	Sprinter Mag 2 Dwr CustomC10776B	\$3,445.00	\$2,950.38
336320	TruckVault Inc.	T-MDSPRM2-06N-PW	Sprinter Mag 2 Dwr	\$3,045.00	\$2,607.81
336320	TruckVault Inc.	T-MDSPRM2-06N-ZC8841	Sprinter Mag 2 Dwr	\$3,055.00	\$2,616.37
336320	TruckVault Inc.	T-MDSPRN1-06N-ZC9643	Sprinter custom 1 Dwr	\$1,455.00	\$1,246.10
336320	TruckVault Inc.	T-MDSPRN3-06N-HT-ZC9105	Sprinter Custom	\$5,875.00	\$5,031.49
336320	TruckVault Inc.	T-MDSPRS2-06F	Sprinter Std 2 Dwr	\$3,445.00	\$2,950.38
336320	TruckVault Inc.	T-MDSPRS2-06M	Sprinter Std 2 Dwr	\$2,845.00	\$2,436.52
336320	TruckVault Inc.	T-MDSPRS2-06N	Sprinter Std 2 Dwr	\$3,445.00	\$2,950.38
336320	TruckVault Inc.	T-MDSPRS2-19N-PT-ZC9801	Sprinter Revel Custom	\$3,425.00	\$2,933.25
336320	TruckVault Inc.	T-MDSPRS3-06N-ZC8496	Sprinter Cust 3 Dwr	\$4,195.00	\$3,592.70
336320	TruckVault Inc.	T-MDSPRSO-06N-PT-ZC11104	Sprinter Std 2 Dwr Offset , Table	\$3,425.00	\$2,933.25
336320	TruckVault Inc.	T-MDSPRSO-06N-PT-ZC9801	Sprinter Revel Custom	\$3,425.00	\$2,933.25
336320	TruckVault Inc.	T-MYMARM1-05N	Mercury Mariner Mag 1 Dwr, dimensions: 27L x 37W	\$2,095.00	\$1,794.21
336320	TruckVault Inc.	T-MYMARM1-08N	Mercury Mariner Mag 1 Dwr, dimensions: 38.5L x 44.5W	\$2,295.00	\$1,965.49
336320	TruckVault Inc.	T-MYMARM2-05N	Mercury Mariner Mag 2 Dwr, dimensions: 27L x 37W	\$2,645.00	\$2,265.24
336320	TruckVault Inc.	T-MYMARM2-05N-PT	Mercury Mariner Mag 2 Dwr, dimensions: 0L x 0W	\$3,340.00	\$2,860.45
336320	TruckVault Inc.	T-MYMARM2-08N	Mercury Mariner Mag 2 Dwr, dimensions: 25L x 40W	\$2,645.00	\$2,265.24
336320	TruckVault Inc.	T-MYMARM2-08N-PT	Mercury Mariner Mag 2 Dwr, dimensions: 0L x 0W	\$3,540.00	\$3,031.74
336320	TruckVault Inc.	T-MYMARS1-05N	Mercury Mariner Std 1 Dwr, dimensions: 29.5L x 37W	\$1,895.00	\$1,622.92
336320	TruckVault Inc.	T-MYMARS1-08N	Mariner Std 1 Dwr	\$1,895.00	\$1,622.92
336320	TruckVault Inc.	T-MYMARS2-05N	Mercury Mariner Std 2 Dwr, dimensions: 29.5L x 37W	\$2,445.00	\$2,093.95
336320	TruckVault Inc.	T-MYMARS2-08N	Mercury Mariner Std 2 Dwr, dimensions: 29.5L x 39W	\$2,445.00	\$2,093.95
336320	TruckVault Inc.	T-MYMTNM1-02N	Mercury Mountaineer Mag 1 Dwr, dimensions: 38L x 41.25W	\$2,295.00	\$1,965.49
336320	TruckVault Inc.	T-MYMTNM1-06N	Mercury Mountaineer Mag 1 Dwr, dimensions: 38L x 41.25W	\$2,295.00	\$1,965.49
336320	TruckVault Inc.	T-MYMTNM1-91N	Mercury Mountaineer Mag 1 Dwr, dimensions: 38L x 41.25W	\$2,295.00	\$1,965.49
336320	TruckVault Inc.	T-MYMTNM2-06N	Mercury Mountaineer Mag 2 Dwr, dimensions: 38.5L x 45.75W	\$2,845.00	\$2,436.52
336320	TruckVault Inc.	T-MYMTNM2-91N	Mercury Mountaineer Mag 2 Dwr, dimensions: 38L x 41.25W	\$2,845.00	\$2,436.52
336320	TruckVault Inc.	T-MYMTNS1-06N-T3	Mercury Mountaineer Std 1 Dwr, dimensions: 38.5L x 44.5W	\$2,095.00	\$1,794.21
336320	TruckVault Inc.	T-MYMTNS1-91N	Mercury Mountaineer Std 1 Dwr, dimensions: 38L x 41.25W	\$2,095.00	\$1,794.21
336320	TruckVault Inc.	T-MYMTNS1-91N-PT	Mountaineer Std 1 Dwr	\$2,790.00	\$2,389.42

336320	TruckVault Inc.	T-MYMTNS2-06N	Mercury Mountaineer Std 2 Dwr, dimensions: 40L x 44.5W	\$2,645.00	\$2,265.24
336320	TruckVault Inc.	T-MYMTNS2-91N	Mercury Mountaineer Std 2 Dwr, dimensions: 38L x 41.25W	\$2,645.00	\$2,265.24
336320	TruckVault Inc.	T-MYMTNSO-91N	Mercury Mountaineer Std OS Dwr, dimensions: 0L x 0W	\$2,645.00	\$2,265.24
336320	TruckVault Inc.	T-MYVILM1-93L	Mercury Villager Mag 1 Dwr, dimensions: 47L x 47W	\$2,295.00	\$1,965.49
336320	TruckVault Inc.	T-MYVILM1-99S	Mercury Villager Mag 1 Dwr, dimensions: 43L x 47W	\$2,295.00	\$1,965.49
336320	TruckVault Inc.	T-MYVILM2-93L	Mercury Villager Mag 2 Dwr, dimensions: 47L x 47W	\$2,435.00	\$2,085.39
336320	TruckVault Inc.	T-MYVILM2-93S	Mercury Villager Mag 2 Dwr, dimensions: 43L x 47W	\$2,845.00	\$2,436.52
336320	TruckVault Inc.	T-MYVILS1-93L	Mercury Villager Std 1 Dwr, dimensions: 47L x 47W	\$2,095.00	\$1,794.21
336320	TruckVault Inc.	T-MYVILS1-93S	Mercury Villager Std 1 Dwr, dimensions: 43L x 47W	\$2,095.00	\$1,794.21
336320	TruckVault Inc.	T-MYVILS2-93L	Mercury Villager Std 2 Dwr, dimensions: 47L x 47W	\$2,645.00	\$2,265.24
336320	TruckVault Inc.	T-MYVILS2-93S	Mercury Villager Std 2 Dwr, dimensions: 43L x 47W	\$2,645.00	\$2,265.24
336320	TruckVault Inc.	T-MZBSES2-99L-PW	Mazda B-Series Pickup Std 2 Dwr, dimensions: 1L x 1W	\$4,345.00	\$3,721.16
336320	TruckVault Inc.	T-MZBSES2-99S	Mazda B-Series Pickup Std 2 Dwr, dimensions: 68.5L x 39W	\$3,145.00	\$2,693.45
336320	TruckVault Inc.	T-MZBSES2-99S-PW	Mazda B-Series Pickup Std 2 Dwr, dimensions: 1L x 1W	\$4,045.00	\$3,464.23
336320	TruckVault Inc.	T-MZCX5M1-13N	CX-5 Mag 1 Dwr	\$2,095.00	\$1,794.21
336320	TruckVault Inc.	T-MZCX5S1-13N	CX-5 Std 1 Dwr	\$1,895.00	\$1,622.92
336320	TruckVault Inc.	T-MZCX7M1-07N	Mazda CX-7 Mag 1 Dwr, dimensions: 0L x 0W	\$2,095.00	\$1,794.21
336320	TruckVault Inc.	T-MZCX7M2-07N	Mazda CX-7 Mag 2 Dwr, dimensions: 0L x 0W	\$2,645.00	\$2,265.24
336320	TruckVault Inc.	T-MZCX7S1-07N	Mazda CX-7 Std 1 Dwr, dimensions: 0L x 0W	\$1,895.00	\$1,622.92
336320	TruckVault Inc.	T-MZCX7S2-07N	Mazda CX-7 Std 2 Dwr, dimensions: 30L x 36W	\$2,445.00	\$2,093.95
336320	TruckVault Inc.	T-MZCX9L1-07N-ZC6990	CX-9 Cust Cargo Area Lidded Vault	\$1,235.00	\$1,057.68
336320	TruckVault Inc.	T-MZCX9M1-07N	Mazda CX-9 Mag 1 Dwr, dimensions: 36L x 43W	\$2,295.00	\$1,965.49
336320	TruckVault Inc.	T-MZCX9M2-07N	Mazda CX-9 Mag 2 Dwr, dimensions: 39L x 43W	\$2,845.00	\$2,436.52
336320	TruckVault Inc.	T-MZCX9S1-07N	Mazda CX-9 Std 1 Dwr, dimensions: 40L x 43W	\$2,095.00	\$1,794.21
336320	TruckVault Inc.	T-MZCX9S2-07N	Mazda CX-9 Std 2 Dwr, dimensions: 40L x 43W	\$2,645.00	\$2,265.24
336320	TruckVault Inc.	T-MZTRIM1-01N	Mazda Tribute Mag 1 Dwr, dimensions: 25.5L x 40.5W	\$2,095.00	\$1,794.21
336320	TruckVault Inc.	T-MZTRIM1-05N	Mazda Tribute Mag 1 Dwr, dimensions: 0L x 0W	\$2,095.00	\$1,794.21
336320	TruckVault Inc.	T-MZTRIM1-08N	Mazda Tribute Mag 1 Dwr, dimensions: 0L x 0W	\$2,095.00	\$1,794.21
336320	TruckVault Inc.	T-MZTRIM2-05N	Mazda Tribute Mag 2 Dwr, dimensions: 0L x 0W	\$2,645.00	\$2,265.24
336320	TruckVault Inc.	T-MZTRIS1-00N	Tribute Std 1 Dwr	\$1,895.00	\$1,622.92
336320	TruckVault Inc.	T-MZTRIS1-05N	Mazda Tribute Std 1 Dwr, dimensions: 0L x 0W	\$1,895.00	\$1,622.92
336320	TruckVault Inc.	T-MZTRIS2-01N	Mazda Tribute Std 2 Dwr, dimensions: 0L x 0W	\$2,445.00	\$2,093.95
336320	TruckVault Inc.	T-MZTRIS2-05N	Mazda Tribute Std 2 Dwr, dimensions: 0L x 0W	\$2,445.00	\$2,093.95
336320	TruckVault Inc.	T-NSARMM1-04N	Nissan Armada Mag 1 Dwr, dimensions: 44L x 48W	\$2,295.00	\$1,965.49
336320	TruckVault Inc.	T-NSARMM1-04N-HD	Armada Mag 1 Dwr	\$1,895.00	\$1,622.92
336320	TruckVault Inc.	T-NSARMM1-16N-TF	Armada Mag 1 DwrThird Row Folded	\$2,295.00	\$1,965.49
336320	TruckVault Inc.	T-NSARMM2-04N	Nissan Armada Mag 2 Dwr, dimensions: 37.5L x 48W	\$2,845.00	\$2,436.52
336320	TruckVault Inc.	T-NSARMM2-16N	Armada Mag 2 Dwr	\$2,845.00	\$2,436.52
336320	TruckVault Inc.	T-NSARMMO-04N	Nissan Armada Mag OS Dwr, dimensions: 37.5L x 48W	\$2,845.00	\$2,436.52
336320	TruckVault Inc.	T-NSARMS1-04N	Nissan Armada Std 1 Dwr, dimensions: 40L x 48W	\$2,095.00	\$1,794.21
336320	TruckVault Inc.	T-NSARMS1-16N	Armada Std 1 Dwr	\$2,095.00	\$1,794.21
336320	TruckVault Inc.	T-NSARMS1-16S	Armada Std 1 Dwr	\$1,695.00	\$1,451.64
336320	TruckVault Inc.	T-NSARMS2-04N	Nissan Armada Std 2 Dwr, dimensions: 40L x 48W	\$2,645.00	\$2,265.24
336320	TruckVault Inc.	T-NSARMS2-16N-TF	Armada Std 2 Dwr	\$2,645.00	\$2,265.24
336320	TruckVault Inc.	T-NSARMSO-04N	Nissan Armada Std OS Dwr, dimensions: 40L x 48W	\$2,645.00	\$2,265.24
336320	TruckVault Inc.	T-NSARMUO-04N-HT	Armada Utility Offset Dwr	\$3,440.00	\$2,946.10
336320	TruckVault Inc.	T-NSFRTM1-05S-PC-HP	Frontier Mag 1 Dwr Half WidthCrew Cab, Passenger Side	\$2,195.00	\$1,879.85
336320	TruckVault Inc.	T-NSFRTM2-05S-PC	Frontier Pickup Mag 2 Dwr	\$3,145.00	\$2,693.45
336320	TruckVault Inc.	T-NSFRTM2-05S-PC-PW	Frontier Pickup Mag 2 Dwr	\$3,945.00	\$3,378.59
336320	TruckVault Inc.	T-NSFRTM2-05S-PW	Frontier Pickup Mag 2 Dwr	\$4,245.00	\$3,635.52
336320	TruckVault Inc.	T-NSFRTM2-98L-PW	Nissan Frontier Pickup Mag 2 Dwr, dimensions: 73L x 43.5W	\$4,305.00	\$3,686.90
336320	TruckVault Inc.	T-NSFRTM2-98S	Frontier Pickup Mag 2 Dwr	\$3,345.00	\$2,864.74
336320	TruckVault Inc.	T-NSFRTM2-98S-PW	Nissan Frontier Pickup Mag 2 Dwr, dimensions: 0L x 0W	\$3,945.00	\$3,378.59
336320	TruckVault Inc.	T-NSFRTMO-05S-PC	Frontier Pickup Mag Offset Dwr	\$3,145.00	\$2,693.45
336320	TruckVault Inc.	T-NSFRTMO-05S-PC-PW	Nissan Frontier Pickup Mag Offset Dwr, dimensions: 56L x 43W	\$3,945.00	\$3,378.59
336320	TruckVault Inc.	T-NSFRTMO-05S-PW	Nissan Frontier Pickup Mag Offset Dwr, dimensions: 71.5L x 43.5W	\$4,245.00	\$3,635.52
336320	TruckVault Inc.	T-NSFRTMO-98L-PW	Nissan Frontier Pickup Mag Offset, dimensions: 73L x 43.5W	\$4,545.00	\$3,892.44
336320	TruckVault Inc.	T-NSFRTS1-05S-HD	Frontier Std 1 Dwr Half Width	\$2,105.00	\$1,802.77
336320	TruckVault Inc.	T-NSFRTS1-05S-PC-HP	Frontier Std 1 Dwr Half Width	\$1,995.00	\$1,708.56
336320	TruckVault Inc.	T-NSFRTS1-05S-PC-HP-PW	Nissan Frontier Pickup Std 1 Dwr, dimensions: 57.5L x 23W	\$2,245.00	\$1,922.67
336320	TruckVault Inc.	T-NSFRTS2-05L-PW	Nissan Frontier Pickup Std 2 Dwr, dimensions: 70L x 44.25W	\$4,045.00	\$3,464.23
336320	TruckVault Inc.	T-NSFRTS2-05S	Frontier Pickup Std 2 Dwr	\$3,145.00	\$2,693.45
336320	TruckVault Inc.	T-NSFRTS2-05S-PC-PW	Nissan Frontier Pickup Std 2 Dwr, dimensions: 57.5L x 43.5W	\$3,745.00	\$3,207.30
336320	TruckVault Inc.	T-NSFRTS2-05S-PW	Nissan Frontier Pickup Std 2 Dwr, dimensions: 71L x 43W	\$4,045.00	\$3,464.23
336320	TruckVault Inc.	T-NSFRTS2-98S	Frontier Pickup Std 2 Dwr	\$3,145.00	\$2,693.45
336320	TruckVault Inc.	T-NSFRTS2-98S-PC-PW	Nissan Frontier Pickup Std 2 Dwr, dimensions: 53L x 43.5W	\$3,745.00	\$3,207.30

336320	TruckVault Inc.	T-NSFRTS2-98S-PW	Nissan Frontier Pickup Std 2 Dwr, dimensions: 1L x 1W	\$4,345.00	\$3,721.16
336320	TruckVault Inc.	T-NSFRTS0-05S-PC-PW	Nissan Frontier Pickup Std Offset Dwr, dimensions: 57.5L x 43.5W	\$3,745.00	\$3,207.30
336320	TruckVault Inc.	T-NSFRTS0-98L-PW	Nissan Frontier Pickup Std OS Dwr, dimensions: 0L x 0W	\$4,345.00	\$3,721.16
336320	TruckVault Inc.	T-NSFRTU2-05S-PC	Frontier Pickup Utility 2 Dwr	\$3,045.00	\$2,607.81
336320	TruckVault Inc.	T-NSFRTU2-05S-PC-PW	Frontier Pickup Utility 2 Dwr	\$3,845.00	\$3,292.95
336320	TruckVault Inc.	T-NSFRTU2-05S-PW	Frontier Pickup Utility 2 Dwr	\$4,145.00	\$3,549.87
336320	TruckVault Inc.	T-NSFRTU0-05S-PC-PW	Frontier Pickup Utility Offset Dwr	\$3,845.00	\$3,292.95
336320	TruckVault Inc.	T-NSKCSM1-16N	Kicks Mag 1 Dwr	\$2,095.00	\$1,794.21
336320	TruckVault Inc.	T-NSKCSM2-16N	Kicks Mag 2 Dwr	\$2,645.00	\$2,265.24
336320	TruckVault Inc.	T-NSMURM1-03N	Nissan Murano Mag 1 Dwr, dimensions: 34L x 36W	\$2,095.00	\$1,794.21
336320	TruckVault Inc.	T-NSMURM1-15N	Murano Mag 1 Dwr	\$2,095.00	\$1,794.21
336320	TruckVault Inc.	T-NSMURM2-03N	Nissan Murano Mag 2 Dwr, dimensions: 34L x 36W	\$2,645.00	\$2,265.24
336320	TruckVault Inc.	T-NSMURS1-03N	Nissan Murano Std 1 Dwr, dimensions: 34L x 36W	\$1,895.00	\$1,622.92
336320	TruckVault Inc.	T-NSMURS1-08N	Nissan Murano Std 1 Dwr, dimensions: 33.5L x 40W	\$1,895.00	\$1,622.92
336320	TruckVault Inc.	T-NSMURS1-15N	Murano Std 1 Dwr	\$1,825.00	\$1,562.97
336320	TruckVault Inc.	T-NSMURS2-03N	Nissan Murano Std 2 Dwr, dimensions: 34L x 36W	\$2,445.00	\$2,093.95
336320	TruckVault Inc.	T-NSMURS2-08N	Nissan Murano Std 2 Dwr, dimensions: 33.5L x 40W	\$2,445.00	\$2,093.95
336320	TruckVault Inc.	T-NSMURU1-08N	Murano Utility 1 Dwr	\$1,995.00	\$1,708.56
336320	TruckVault Inc.	T-NSNV2M2-09N	NV200 Mag 2 Dwr	\$3,445.00	\$2,950.38
336320	TruckVault Inc.	T-NSNV2S2-09N	NV200 Std 2 Dwr	\$3,245.00	\$2,779.09
336320	TruckVault Inc.	T-NSNV2U2-09N	NV200 Utility 2 Dwr	\$3,245.00	\$2,779.09
336320	TruckVault Inc.	T-NSPTHM1-05N	Nissan Pathfinder Mag 1 Dwr, dimensions: 37L x 43.5W	\$2,295.00	\$1,965.49
336320	TruckVault Inc.	T-NSPTHM1-13N	Nissan Pathfinder Mag 1 Dwr, dimensions: 36L x 40W	\$2,295.00	\$1,965.49
336320	TruckVault Inc.	T-NSPTHM1-13N-PP	Nissan Pathfinder Mag 1 Dwr, dimensions: 33L x 40W	\$2,095.00	\$1,794.21
336320	TruckVault Inc.	T-NSPTHM1-96N	Nissan Pathfinder Mag 1 Dwr, dimensions: 29L x 37.5W	\$2,095.00	\$1,794.21
336320	TruckVault Inc.	T-NSPTHM2-05N	Nissan Pathfinder Mag 2 Dwr, dimensions: 36L x 43.5W	\$2,845.00	\$2,436.52
336320	TruckVault Inc.	T-NSPTHM2-13N	Pathfinder Mag 2 Dwr	\$2,845.00	\$2,436.52
336320	TruckVault Inc.	T-NSPTHM2-96N	Nissan Pathfinder Mag 2 Dwr, dimensions: 29L x 37.5W	\$2,645.00	\$2,265.24
336320	TruckVault Inc.	T-NSPTHMO-05N	Nissan Pathfinder Mag Offset Dwr, dimensions: 36L x 43.5W	\$2,845.00	\$2,436.52
336320	TruckVault Inc.	T-NSPTHMO-13N	Pathfinder Mag Offset Dwr	\$2,845.00	\$2,436.52
336320	TruckVault Inc.	T-NSPTHS1-05N	Nissan Pathfinder Std 1 Dwr, dimensions: 38L x 43.5W	\$2,095.00	\$1,794.21
336320	TruckVault Inc.	T-NSPTHS1-13N	Pathfinder Std 1 Dwr	\$2,095.00	\$1,794.21
336320	TruckVault Inc.	T-NSPTHS1-13S	Pathfinder Std 1 Dwr	\$1,695.00	\$1,451.64
336320	TruckVault Inc.	T-NSPTHS1-96N	Nissan Pathfinder Std 1 Dwr, dimensions: 36L x 37.5W	\$2,095.00	\$1,794.21
336320	TruckVault Inc.	T-NSPTHS2-05N	Nissan Pathfinder Std 2 Dwr, dimensions: 38L x 43.5W	\$2,645.00	\$2,265.24
336320	TruckVault Inc.	T-NSPTHS2-13N	Pathfinder Std 2 Dwr	\$2,645.00	\$2,265.24
336320	TruckVault Inc.	T-NSPTHS2-13N-PP	Pathfinder Std 2 DwrCage Present	\$2,445.00	\$2,093.95
336320	TruckVault Inc.	T-NSPTHS2-96N	Nissan Pathfinder Std 2 Dwr, dimensions: 31L x 37.5W	\$2,445.00	\$2,093.95
336320	TruckVault Inc.	T-NSPTHSO-05N	Nissan Pathfinder Std Offset Dwr, dimensions: 38L x 43.5W	\$2,645.00	\$2,265.24
336320	TruckVault Inc.	T-NSPTHSO-05N-PT	Nissan Pathfinder Std Offset Dwr, dimensions: 37L x 43.5W	\$3,340.00	\$2,860.45
336320	TruckVault Inc.	T-NSPTHSO-96N	Nissan Pathfinder Std Offset Dwr, dimensions: 31L x 37.5W	\$2,445.00	\$2,093.95
336320	TruckVault Inc.	T-NSPTHU1-05N	Pathfinder Utility 1 Dwr	\$2,195.00	\$1,879.85
336320	TruckVault Inc.	T-NSPTHU1-13N	Pathfinder Utility 1 Dwr	\$2,195.00	\$1,879.85
336320	TruckVault Inc.	T-NSPTHU2-13N	Pathfinder Utility 2 Dwr	\$2,745.00	\$2,350.88
336320	TruckVault Inc.	T-NSQSTM1-04N	Nissan Quest Mag 1 Dwr, dimensions: 55L x 47W	\$2,435.00	\$2,085.39
336320	TruckVault Inc.	T-NSQSTM1-10N	Quest Mag 1 Dwr	\$2,295.00	\$1,965.49
336320	TruckVault Inc.	T-NSQSTM1-99N	Nissan Quest Mag 1 Dwr, dimensions: 31.5L x 48W	\$2,095.00	\$1,794.21
336320	TruckVault Inc.	T-NSQSTM2-00N	Nissan Quest Mag 2 Dwr, dimensions: 31.5L x 48W	\$2,645.00	\$2,265.24
336320	TruckVault Inc.	T-NSQSTS1-00N	Nissan Quest Std 1 Dwr, dimensions: 31.5L x 48W	\$1,895.00	\$1,622.92
336320	TruckVault Inc.	T-NSQSTS1-10N	Quest Std 1 Dwr	\$2,095.00	\$1,794.21
336320	TruckVault Inc.	T-NSQSTS2-00N	Nissan Quest Std 2 Dwr, dimensions: 31.5L x 48W	\$2,445.00	\$2,093.95
336320	TruckVault Inc.	T-NSROGM1-07N	Rogue Mag 1 Drawer	\$1,895.00	\$1,622.92
336320	TruckVault Inc.	T-NSROGM1-14N	Rogue Mag 1 Drawer	\$2,095.00	\$1,794.21
336320	TruckVault Inc.	T-NSROGM2-07N	Rogue Mag 2 Drawer	\$2,445.00	\$2,093.95
336320	TruckVault Inc.	T-NSROGS1-07N	Nissan Rogue Std 1 Drawer, dimensions: 29L x 33W	\$1,695.00	\$1,451.64
336320	TruckVault Inc.	T-NSROGS1-14N	Rogue Std 1 Drawer	\$1,895.00	\$1,622.92
336320	TruckVault Inc.	T-NSROGS2-07N	Nissan Rogue Std 2 Drawer, dimensions: 29L x 38W	\$2,325.00	\$1,991.18
336320	TruckVault Inc.	T-NSROGS2-14N	Rogue Std 2 Drawer	\$2,445.00	\$2,093.95
336320	TruckVault Inc.	T-NSROGU1-14N	Rogue Utility 1 Drawer	\$1,995.00	\$1,708.56
336320	TruckVault Inc.	T-NSTITM1-04S-HP	Titan Mag 1 Dwr Half Width	\$2,545.00	\$2,179.60
336320	TruckVault Inc.	T-NSTITM1-04S-HP-PW	Titan Mag 1 Dwr Half Width6"; Passenger Side AW	\$3,045.00	\$2,607.81
336320	TruckVault Inc.	T-NSTITM1-04S-PC-HP-PW	Titan Mag 1 Dwr Half Width5"; Passenger Side AW	\$2,745.00	\$2,350.88
336320	TruckVault Inc.	T-NSTITM2-04S	Nissan Titan Pickup Mag 2 Dwr, dimensions: 76L x 48W	\$3,745.00	\$3,207.30
336320	TruckVault Inc.	T-NSTITM2-04S-PC	Nissan Titan Pickup Mag 2 Dwr, dimensions: 64L x 48W	\$3,545.00	\$3,036.02
336320	TruckVault Inc.	T-NSTITM2-04S-PC-PW	Nissan Titan Pickup Mag 2 Dwr, dimensions: 65L x 48W	\$4,345.00	\$3,721.16
336320	TruckVault Inc.	T-NSTITM2-04S-PT	Nissan Titan Pickup Mag 2 Dwr, dimensions: 0L x 0W	\$4,260.00	\$3,648.36

336320	TruckVault Inc.	T-NSTITM2-04S-PW	Nissan Titan Pickup Mag 2 Dwr, dimensions: 76L x 48W	\$4,645.00	\$3,978.09
336320	TruckVault Inc.	T-NSTITM2-16S-TB-PW	Titan Pickup Mag 2 DwrMag Extreme Tool Boxes	\$4,045.00	\$3,464.23
336320	TruckVault Inc.	T-NSTITMO-04S	Titan Pickup Mag 2 Dwr Offset	\$3,745.00	\$3,207.30
336320	TruckVault Inc.	T-NSTITMO-04S-PC	Nissan Titan Pickup Mag OS Dwr, dimensions: 64L x 48W	\$3,245.00	\$2,779.09
336320	TruckVault Inc.	T-NSTITMO-04S-PC-PT	Nissan Titan Pickup Mag OS Dwr, dimensions: 64L x 48W	\$3,940.00	\$3,374.31
336320	TruckVault Inc.	T-NSTITMO-04S-PC-PW	Nissan Titan Pickup Mag Offset, dimensions: 65L x 48W	\$4,345.00	\$3,721.16
336320	TruckVault Inc.	T-NSTITMO-04S-PT	Nissan Titan Pickup Mag Offset Dwr, dimensions: 75L x 48W	\$4,140.00	\$3,545.59
336320	TruckVault Inc.	T-NSTITMO-04S-PW	Nissan Titan Pickup Mag Offset, dimensions: 76L x 48W	\$4,645.00	\$3,978.09
336320	TruckVault Inc.	T-NSTITMO-16S-TB	Titan Pickup Mag 2 Dwr Offset	\$3,205.00	\$2,744.84
336320	TruckVault Inc.	T-NSTITN2-04S-PC-ZC8905	Titan Pickup Custom	\$3,505.00	\$3,001.76
336320	TruckVault Inc.	T-NSTITS1-16N-ZC8674	Titan Std 1 Dwr Cust Size	\$2,135.00	\$1,828.46
336320	TruckVault Inc.	T-NSTITS2-04S	Nissan Titan Pickup Std 2 Dwr, dimensions: 76L x 48W	\$3,545.00	\$3,036.02
336320	TruckVault Inc.	T-NSTITS2-04S-PC	Nissan Titan Pickup Std 2 Dwr, dimensions: 64L x 48W	\$3,345.00	\$2,864.74
336320	TruckVault Inc.	T-NSTITS2-04S-PC-PW	Nissan Titan Pickup Std 2 Dwr, dimensions: 65L x 48W	\$4,145.00	\$3,549.87
336320	TruckVault Inc.	T-NSTITS2-04S-PW	Nissan Titan Pickup Std 2 Dwr, dimensions: 76L x 48W	\$4,445.00	\$3,806.80
336320	TruckVault Inc.	T-NSTITS2-16L	Titan Pickup Std 2 DwrLong Bed	\$3,745.00	\$3,207.30
336320	TruckVault Inc.	T-NSTITS2-16L-PW	Titan Pickup Std 2 Dwr	\$4,745.00	\$4,063.73
336320	TruckVault Inc.	T-NSTITS2-16S-TB	Titan Pickup Std 2 Dwr	\$2,985.00	\$2,556.42
336320	TruckVault Inc.	T-NSTITS2-16S-TB-PW	Titan Pickup Std 2 Dwr	\$3,845.00	\$3,292.95
336320	TruckVault Inc.	T-NSTITSO-04S	Nissan Titan Pickup Std Offset Dwr, dimensions: 76L x 48W	\$3,245.00	\$2,779.09
336320	TruckVault Inc.	T-NSTITSO-04S-PC	Nissan Titan Pickup Std OS Dwr, dimensions: 64L x 48W	\$3,045.00	\$2,607.81
336320	TruckVault Inc.	T-NSTITSO-04S-PC-PW	Nissan Titan Pickup Std OS Dwr, dimensions: 65L x 48W	\$4,145.00	\$3,549.87
336320	TruckVault Inc.	T-NSTITSO-04S-PW	Nissan Titan Pickup Std Offset Dwr, dimensions: 76.5L x 48W	\$4,445.00	\$3,806.80
336320	TruckVault Inc.	T-NSTITSO-16S-TB-PW	Titan Pickup Std Offset Dwr	\$3,845.00	\$3,292.95
336320	TruckVault Inc.	T-NSTITU1-04S-HP	Titan Utility 1 Dwr Half Width	\$2,225.00	\$1,905.54
336320	TruckVault Inc.	T-NSTITU2-04S-PC	Titan Pickup utility 2 Dwr	\$3,445.00	\$2,950.38
336320	TruckVault Inc.	T-NSTITU2-04S-PC-PW	Titan Pickup Utility 2 DwrCrew Cab, A-Wthr	\$4,245.00	\$3,635.52
336320	TruckVault Inc.	T-NSTITU2-16S-TB	Titan Pickup utility 2 Dwr	\$3,095.00	\$2,650.63
336320	TruckVault Inc.	T-NSTITU2-16S-TB-PW	Titan Pickup utility 2 Dwr	\$3,945.00	\$3,378.59
336320	TruckVault Inc.	T-NSXTEM1-00N	Nissan X-Terra Mag 1 Dwr, dimensions: 30.5L x 41.5W	\$2,095.00	\$1,794.21
336320	TruckVault Inc.	T-NSXTEM1-05N	Nissan X-Terra Mag 1 Dwr, dimensions: 29.5L x 39.5W	\$2,095.00	\$1,794.21
336320	TruckVault Inc.	T-NSXTEM2-00N	Nissan X-Terra Mag 2 Dwr, dimensions: 30.5L x 41.5W	\$2,645.00	\$2,265.24
336320	TruckVault Inc.	T-NSXTEM2-05N	Nissan X-Terra Mag 2 Dwr, dimensions: 29.5L x 39.5W	\$2,645.00	\$2,265.24
336320	TruckVault Inc.	T-NSXTEMO-05N	Nissan X-Terra Mag OS Dwr, dimensions: 29.5L x 39.5W	\$2,645.00	\$2,265.24
336320	TruckVault Inc.	T-NSXTES1-00N	Nissan X-Terra Std 1 Dwr, dimensions: 32L x 41.5W	\$1,895.00	\$1,622.92
336320	TruckVault Inc.	T-NSXTES1-05N	Nissan X-Terra Std 1 Dwr, dimensions: 31L x 39.5W	\$1,895.00	\$1,622.92
336320	TruckVault Inc.	T-NSXTES1-05N-HP	X-Terra Std 1 Dwr Half-Width	\$1,495.00	\$1,280.35
336320	TruckVault Inc.	T-NSXTES2-00N	Nissan X-Terra Std 2 Dwr, dimensions: 32L x 41.5W	\$2,445.00	\$2,093.95
336320	TruckVault Inc.	T-NSXTES2-05N	Nissan X-Terra Std 2 Dwr, dimensions: 31L x 39.5W	\$2,445.00	\$2,093.95
336320	TruckVault Inc.	T-NSXTESO-00N	Nissan X-Terra Std OS Dwr, dimensions: 32L x 41.5W	\$2,445.00	\$2,093.95
336320	TruckVault Inc.	T-NSXTESO-05N	X-Terra Std O/S Dwr	\$2,445.00	\$2,093.95
336320	TruckVault Inc.	T-NSXTEU1-05N-PT	X-Terra Utility 1 Dwr	\$2,690.00	\$2,303.78
336320	TruckVault Inc.	T-NSXTEU2-05N-HT	X-Terra Utility 2 Dwr	\$3,240.00	\$2,774.81
336320	TruckVault Inc.	T-NSXTRM1-01N	Nissan X-Trail Mag 1 Dwr, dimensions: 0L x 0W	\$2,095.00	\$1,794.21
336320	TruckVault Inc.	T-NSXTRM2-01N	Nissan X-Trail Mag 2 Dwr, dimensions: 0L x 0W	\$2,645.00	\$2,265.24
336320	TruckVault Inc.	T-NSXTRS1-01N	Nissan X-Trail Std 1 Dwr, dimensions: 0L x 0W	\$1,895.00	\$1,622.92
336320	TruckVault Inc.	T-NSXTRS2-01N	Nissan X-Trail Std 2 Dwr, dimensions: 0L x 0W	\$2,445.00	\$2,093.95
336320	TruckVault Inc.	T-OLBRVM1-95N	Oldsmobile Bravada Mag 1 Dwr, dimensions: 33L x 38W	\$2,095.00	\$1,794.21
336320	TruckVault Inc.	T-OLBRVM2-95N	Oldsmobile Bravada Mag 2 Dwr, dimensions: 33L x 38W	\$2,645.00	\$2,265.24
336320	TruckVault Inc.	T-OLBRVS1-95N	Oldsmobile Bravada Std 1 Dwr, dimensions: 35L x 38W	\$1,895.00	\$1,622.92
336320	TruckVault Inc.	T-OLBRVS2-95N	Oldsmobile Bravada Std 2 Dwr, dimensions: 35L x 38W	\$2,445.00	\$2,093.95
336320	TruckVault Inc.	T-OLSILM2-97S	Oldsmobile Silhouette Mag 2 Dwr, dimensions: 43L x 47W	\$2,845.00	\$2,436.52
336320	TruckVault Inc.	T-OLSILS2-97S	Oldsmobile Silhouette Std 2 Dwr, dimensions: 43L x 47W	\$2,645.00	\$2,265.24
336320	TruckVault Inc.	T-OPINWM1-09N	Insignia Mag 1 Dwr	\$2,295.00	\$1,965.49
336320	TruckVault Inc.	T-PLGVYM1-83L	Plymouth Grand Voyager Mag 1 Dwr, dimensions: 47L x 47W	\$2,295.00	\$1,965.49
336320	TruckVault Inc.	T-PLGVYM2-99L	Plymouth Grand Voyager Mag 2 Dwr, dimensions: 47L x 47W	\$2,845.00	\$2,436.52
336320	TruckVault Inc.	T-PLGVYS1-83L	Plymouth Grand Voyager Std 1 Dwr, dimensions: 47L x 47W	\$2,095.00	\$1,794.21
336320	TruckVault Inc.	T-PLGVYS2-83L	Plymouth Grand Voyager Std 2 Dwr, dimensions: 47L x 47W	\$2,645.00	\$2,265.24
336320	TruckVault Inc.	T-PLVOYM1-83S	Plymouth Voyager Mag 1 Dwr, dimensions: 42L x 47W	\$2,295.00	\$1,965.49
336320	TruckVault Inc.	T-PLVOYM2-83S	Plymouth Voyager Mag 2 Dwr, dimensions: 42L x 47W	\$2,845.00	\$2,436.52
336320	TruckVault Inc.	T-PLVOYS1-83S	Plymouth Voyager Std 1 Dwr, dimensions: 43L x 47W	\$2,095.00	\$1,794.21
336320	TruckVault Inc.	T-PLVOYS2-83S	Plymouth Voyager Std 2 Dwr, dimensions: 43L x 47W	\$2,645.00	\$2,265.24
336320	TruckVault Inc.	T-POAZTM1-01N	Pontiac Aztek Mag 1 Dwr, dimensions: 0L x 0W	\$2,225.00	\$1,905.54
336320	TruckVault Inc.	T-POAZTM2-01N	Pontiac Aztek Mag 2 Dwr, dimensions: 0L x 0W	\$2,725.00	\$2,333.75
336320	TruckVault Inc.	T-POAZTS1-01N	Pontiac Aztek Std 1 Dwr, dimensions: 0L x 0W	\$2,025.00	\$1,734.26
336320	TruckVault Inc.	T-POAZTS2-01N	Pontiac Aztek Std 2 Dwr, dimensions: 0L x 0W	\$2,525.00	\$2,162.47

336320	TruckVault Inc.	T-POTORM1-06N	Pontiac Torrent Mag 1 Drawer, dimensions: 31L x 37.25W	\$2,095.00	\$1,794.21
336320	TruckVault Inc.	T-POTORM2-06N	Pontiac Torrent Mag 2 Drawer, dimensions: 31L x 37.25W	\$2,645.00	\$2,265.24
336320	TruckVault Inc.	T-POTORS1-06N	Pontiac Torrent Std 1 Drawer, dimensions: 31L x 37.25W	\$1,895.00	\$1,622.92
336320	TruckVault Inc.	T-POTORS2-06N	Pontiac Torrent Std 2 Drawer, dimensions: 31L x 37.25W	\$2,445.00	\$2,093.95
336320	TruckVault Inc.	T-POVIBM1-03N	Pontiac Vibe Mag 1 Dwr, dimensions: 0L x 0W	\$2,095.00	\$1,794.21
336320	TruckVault Inc.	T-POVIBM2-03N	Pontiac Vibe Mag 2 Dwr, dimensions: 0L x 0W	\$2,645.00	\$2,265.24
336320	TruckVault Inc.	T-POVIBS1-03N	Pontiac Vibe Std 1 Dwr, dimensions: 0L x 0W	\$1,895.00	\$1,622.92
336320	TruckVault Inc.	T-POVIBS2-03N	Pontiac Vibe Std 2 Dwr, dimensions: 0L x 0W	\$2,445.00	\$2,093.95
336320	TruckVault Inc.	T-PRCYNM1-02N	Porsche Cayenne Mag 1 Dwr, dimensions: 32L x 38.25W	\$2,095.00	\$1,794.21
336320	TruckVault Inc.	T-PRCYNM1-03N	Porsche Cayenne Mag 1 Dwr, dimensions: 32L x 38.25W	\$2,095.00	\$1,794.21
336320	TruckVault Inc.	T-PRCYNM1-11N	Porsche Cayenne Mag 1 Dwr, dimensions: 28L x 39.5W	\$2,095.00	\$1,794.21
336320	TruckVault Inc.	T-PRCYNM2-03N	Porsche Cayenne Mag 2 Dwr, dimensions: 32L x 38.25W	\$2,645.00	\$2,265.24
336320	TruckVault Inc.	T-PRCYNMO-03N	Porsche Cayenne Mag Offset Dwr, dimensions: 32L x 38.25W	\$2,645.00	\$2,265.24
336320	TruckVault Inc.	T-PRCYNS1-03N	Porsche Cayenne Std 1 Dwr, dimensions: 34L x 38.25W	\$1,895.00	\$1,622.92
336320	TruckVault Inc.	T-PRCYNS1-11N	Porsche Cayenne Std 1 Dwr, dimensions: 31L x 39.5W	\$1,895.00	\$1,622.92
336320	TruckVault Inc.	T-PRCYNS2-03N	Porsche Cayenne Std 2 Dwr, dimensions: 34L x 38.25W	\$2,445.00	\$2,093.95
336320	TruckVault Inc.	T-PRCYNS2-11N	Porsche Cayenne Std 2 Dwr, dimensions: 31L x 39.5W	\$2,445.00	\$2,093.95
336320	TruckVault Inc.	T-PRCYNSO-11N	Cayenne Std 2 Dwr Offset	\$2,445.00	\$2,093.95
336320	TruckVault Inc.	T-PRMCNS1-18N	Macan Std 1 Dwr	\$1,695.00	\$1,451.64
336320	TruckVault Inc.	T-PRMCNS2-18N	Macan Std 2 Dwr	\$2,245.00	\$1,922.67
336320	TruckVault Inc.	T-PRPANS1-10N	Panamera Std 1 Dwr	\$1,495.00	\$1,280.35
336320	TruckVault Inc.	T-PRPANS2-10N	Panamera Std 2 Dwr	\$2,045.00	\$1,751.39
336320	TruckVault Inc.	T-SAOUTM1-07N	Saturn Outlook Mag 1 Dwr, dimensions: 0L x 0W	\$2,295.00	\$1,965.49
336320	TruckVault Inc.	T-SAOUTM2-07N	Saturn Outlook Mag 2 Dwr, dimensions: 0L x 0W	\$2,435.00	\$2,085.39
336320	TruckVault Inc.	T-SAOUTS1-07N	Saturn Outlook Std 1 Dwr, dimensions: 46L x 45.5W	\$2,095.00	\$1,794.21
336320	TruckVault Inc.	T-SAOUTS2-07N	Saturn Outlook Std 2 Dwr, dimensions: 46L x 45.5W	\$2,645.00	\$2,265.24
336320	TruckVault Inc.	T-SAVUEM1-08N	Saturn Vue Mag 1 Dwr, dimensions: 27L x 37.5W	\$2,095.00	\$1,794.21
336320	TruckVault Inc.	T-SAVUEM2-08N	Saturn Vue Mag 2 Dwr, dimensions: 27L x 37.5W	\$2,645.00	\$2,265.24
336320	TruckVault Inc.	T-SAVUES1-08N	Saturn Vue Std 1 Dwr, dimensions: 28L x 37.5W	\$1,895.00	\$1,622.92
336320	TruckVault Inc.	T-SAVUES2-08N	Saturn Vue Std 2 Dwr, dimensions: 28L x 37.5W	\$2,445.00	\$2,093.95
336320	TruckVault Inc.	T-SBASCMS1-19N	Ascent Mag 1 Dwr	\$2,295.00	\$1,965.49
336320	TruckVault Inc.	T-SBASCN1-19N-ZC10211	Ascent 18" 1 Dwr	\$2,855.00	\$2,445.09
336320	TruckVault Inc.	T-SBASCS1-19N	Ascent Std 1 Dwr	\$2,095.00	\$1,794.21
336320	TruckVault Inc.	T-SBBAJS1-03N-PW	Subaru Baja Std 1 Dwr, dimensions: 39.5L x 39W	\$2,435.00	\$2,085.39
336320	TruckVault Inc.	T-SBCTRM1-13N	Crosstrek Mag 1 Dwr	\$1,695.00	\$1,451.64
336320	TruckVault Inc.	T-SBCTRM1-18N	Crosstrek Mag 1 Dwr	\$1,625.00	\$1,391.69
336320	TruckVault Inc.	T-SBCTRM2-13N	Crosstrek Mag 2 Dwr	\$2,245.00	\$1,922.67
336320	TruckVault Inc.	T-SBCTRM2-18N	Crosstrek Mag 2 Dwr	\$2,445.00	\$2,093.95
336320	TruckVault Inc.	T-SBCTRS1-13N	Crosstrek Std 1 Dwr	\$1,695.00	\$1,451.64
336320	TruckVault Inc.	T-SBCTRS1-18N	Crosstrek Std 1 Dwr	\$1,775.00	\$1,520.15
336320	TruckVault Inc.	T-SBCTRS2-13N	Crosstrek Std 2 Dwr	\$2,245.00	\$1,922.67
336320	TruckVault Inc.	T-SBCTRUO-18N	Crosstrek Utility 2 Dwr Offset	\$2,405.00	\$2,059.70
336320	TruckVault Inc.	T-SBFORM1-03N	Subaru Forester Mag 1 Dwr, dimensions: 0L x 0W	\$2,095.00	\$1,794.21
336320	TruckVault Inc.	T-SBFORM1-08N	Subaru Forester Mag 1 Dwr, dimensions: 29L x 40W	\$2,095.00	\$1,794.21
336320	TruckVault Inc.	T-SBFORM1-14N	Subaru Forester Mag 1 Dwr, dimensions: 28L x 40W	\$2,095.00	\$1,794.21
336320	TruckVault Inc.	T-SBFORM1-19N	Forester Mag 1 Dwr	\$2,095.00	\$1,794.21
336320	TruckVault Inc.	T-SBFORM2-03N	Subaru Forester Mag 2 Dwr, dimensions: 31L x 36W	\$2,645.00	\$2,265.24
336320	TruckVault Inc.	T-SBFORM2-14N	Forester Mag 2 Dwr	\$2,645.00	\$2,265.24
336320	TruckVault Inc.	T-SBFORMO-03N	Subaru Forester Mag Offset, dimensions: 0L x 0W	\$2,645.00	\$2,265.24
336320	TruckVault Inc.	T-SBFORS1-03N	Subaru Forester Std 1 Dwr, dimensions: 33.5L x 36W	\$1,895.00	\$1,622.92
336320	TruckVault Inc.	T-SBFORS1-08N	Subaru Forester Std 1 Dwr, dimensions: 29L x 38W	\$1,895.00	\$1,622.92
336320	TruckVault Inc.	T-SBFORS1-14N	Forester Std 1 Dwr	\$1,895.00	\$1,622.92
336320	TruckVault Inc.	T-SBFORS1-19N	Forester Std 1 Dwr	\$1,895.00	\$1,622.92
336320	TruckVault Inc.	T-SBFORS1-97N	Forester Std 1 Dwr	\$1,895.00	\$1,622.92
336320	TruckVault Inc.	T-SBFORS2-03N	Subaru Forester Std 2 Dwr, dimensions: 33.5L x 36W	\$2,445.00	\$2,093.95
336320	TruckVault Inc.	T-SBFORS2-14N	Forester Std 2 Dwr	\$2,445.00	\$2,093.95
336320	TruckVault Inc.	T-SBFORSO-08N	Forester Std Offset	\$2,445.00	\$2,093.95
336320	TruckVault Inc.	T-SBFORSO-14N	Forester Std Offset	\$2,445.00	\$2,093.95
336320	TruckVault Inc.	T-SBIMPS1-11N	Subaru Impreza Std 1 Dwr, dimensions: 22.5L x 35.5W	\$1,495.00	\$1,280.35
336320	TruckVault Inc.	T-SBIMPS2-11N	Impreza Std 2 Dwr	\$2,045.00	\$1,751.39
336320	TruckVault Inc.	T-SBOUTM1-05N	Subaru Outback Mag 1 Dwr, dimensions: 34L x 40W	\$2,095.00	\$1,794.21
336320	TruckVault Inc.	T-SBOUTM1-09N	Subaru Outback Mag 1 Dwr, dimensions: 32.5L x 41W	\$2,095.00	\$1,794.21
336320	TruckVault Inc.	T-SBOUTM1-09N-HT	Outback Mag 1 Dwr	\$2,790.00	\$2,389.42
336320	TruckVault Inc.	T-SBOUTM1-15N	Outback Mag 1 Dwr	\$2,095.00	\$1,794.21
336320	TruckVault Inc.	T-SBOUTM1-15N-HT	Outback Mag 1 Dwr	\$2,790.00	\$2,389.42
336320	TruckVault Inc.	T-SBOUTM2-05N	Subaru Outback Mag 2 Dwr, dimensions: 0L x 0W	\$2,645.00	\$2,265.24

336320	TruckVault Inc.	T-SBOUTM2-15N	Outback Mag 2 Dwr	\$2,645.00	\$2,265.24
336320	TruckVault Inc.	T-SBOUTMO-05N	Subaru Outback Mag Offset, dimensions: 34L x 40W	\$2,645.00	\$2,265.24
336320	TruckVault Inc.	T-SBOUTMO-05N-PT	Subaru Outback Mag Offset, dimensions: 34L x 40W	\$3,340.00	\$2,860.45
336320	TruckVault Inc.	T-SBOUTMO-09N	Outback Mag OS Dwr	\$2,645.00	\$2,265.24
336320	TruckVault Inc.	T-SBOUTMO-15N	Outback Mag Offset Dwr	\$2,645.00	\$2,265.24
336320	TruckVault Inc.	T-SBOUTS1-05N	Subaru Outback Std 1 Dwr, dimensions: 36L x 40W	\$2,095.00	\$1,794.21
336320	TruckVault Inc.	T-SBOUTS1-09N	Subaru Outback Std 1 Dwr, dimensions: 34.5L x 41W	\$1,895.00	\$1,622.92
336320	TruckVault Inc.	T-SBOUTS1-15N	Outback Std 1 Dwr	\$1,895.00	\$1,622.92
336320	TruckVault Inc.	T-SBOUTS2-00N	Outback Std 2 Dwr	\$2,645.00	\$2,265.24
336320	TruckVault Inc.	T-SBOUTS2-03N	Subaru Outback Std 2 Dwr, dimensions: 1L x 1W	\$2,645.00	\$2,265.24
336320	TruckVault Inc.	T-SBOUTS2-05N	Subaru Outback Std 2 Dwr, dimensions: 36L x 40W	\$2,645.00	\$2,265.24
336320	TruckVault Inc.	T-SBOUTS2-09N	Subaru Outback Std 2 Dwr, dimensions: 34L x 40W	\$2,445.00	\$2,093.95
336320	TruckVault Inc.	T-SBOUTS2-15N	Outback Std 2 Dwr	\$2,445.00	\$2,093.95
336320	TruckVault Inc.	T-SBOUTSO-09N	Subaru Outback Std Offset Dwr, dimensions: 34.5L x 41W	\$2,445.00	\$2,093.95
336320	TruckVault Inc.	T-SBOUTSO-15N	Outback Std 2 Dwr Offset	\$2,445.00	\$2,093.95
336320	TruckVault Inc.	T-SBOUTSO-98N-PT	Subaru Outback Std Offset, dimensions: 35L x 40W	\$3,140.00	\$2,689.17
336320	TruckVault Inc.	T-SBOUTU1-15N	Outback Utility 1 Dwr	\$1,995.00	\$1,708.56
336320	TruckVault Inc.	T-SBOUTU2-15N	Outback Utility 2 Dwr	\$2,545.00	\$2,179.60
336320	TruckVault Inc.	T-SBTRIM1-05N	Subaru Tribeca Mag 1 Dwr, dimensions: 34L x 40W	\$2,095.00	\$1,794.21
336320	TruckVault Inc.	T-SBTRIM2-05N	Subaru Tribeca Mag 2 Dwr, dimensions: 31.5L x 42W	\$2,645.00	\$2,265.24
336320	TruckVault Inc.	T-SBTRIMO-05N	Subaru Tribeca Mag OS Dwr, dimensions: 31.5L x 42W	\$2,645.00	\$2,265.24
336320	TruckVault Inc.	T-SBTRIS1-05N	Subaru Tribeca Std 1 Dwr, dimensions: 35L x 42W	\$1,895.00	\$1,622.92
336320	TruckVault Inc.	T-SBTRIS2-05N	Subaru Tribeca Std 2 Dwr, dimensions: 35L x 42W	\$2,445.00	\$2,093.95
336320	TruckVault Inc.	T-SCXXBM1-08N	XB Mag 1 Dwr	\$1,895.00	\$1,622.92
336320	TruckVault Inc.	T-SCXXBS1-08N	XB Std 1 Dwr	\$1,695.00	\$1,451.64
336320	TruckVault Inc.	T-SCXXBS2-08N	XB Std 2 Dwr	\$2,245.00	\$1,922.67
336320	TruckVault Inc.	T-TSML3M1-17N-ZC10773A	Model 3 Mag 1 DwrC10773A	\$2,325.00	\$1,991.18
336320	TruckVault Inc.	T-TSMLXS2-16N	Model X Std 2 Dwr	\$2,645.00	\$2,265.24
336320	TruckVault Inc.	T-TSMLYL2-20N	Model Y Floor Vault	\$1,795.00	\$1,537.28
336320	TruckVault Inc.	T-TY4RUM1-03M-PT	Toyota 4-Runner Mag 1 Dwr, dimensions: 34L x 41W	\$2,790.00	\$2,389.42
336320	TruckVault Inc.	T-TY4RUM1-03N	Toyota 4-Runner Mag 1 Dwr, dimensions: 35L x 41W	\$2,095.00	\$1,794.21
336320	TruckVault Inc.	T-TY4RUM1-10N	Toyota 4-Runner Mag 1 Dwr, dimensions: 33.75L x 41.5W	\$2,095.00	\$1,794.21
336320	TruckVault Inc.	T-TY4RUM1-10N-HT	4-Runner Mag 1 Dwr	\$2,790.00	\$2,389.42
336320	TruckVault Inc.	T-TY4RUM1-10N-PG	Toyota 4-Runner Mag 1 Dwr, dimensions: 24L x 42.5W	\$2,095.00	\$1,794.21
336320	TruckVault Inc.	T-TY4RUM1-10N-RT	4-Runner Mag 1 Dwr table removed	\$2,095.00	\$1,794.21
336320	TruckVault Inc.	T-TY4RUM1-10N-T3	Toyota 4-Runner Mag 1 Dwr, dimensions: 32L x 43W	\$2,095.00	\$1,794.21
336320	TruckVault Inc.	T-TY4RUM1-10N-T3-HT	4-Runner Mag 1 Dwr HD TableFold 3rd Row Seating	\$2,790.00	\$2,389.42
336320	TruckVault Inc.	T-TY4RUM1-84N	4-Runner Mag 1 Dwr	\$2,295.00	\$1,965.49
336320	TruckVault Inc.	T-TY4RUM1-96N	Toyota 4-Runner Mag 1 Dwr, dimensions: 38L x 38.75W	\$2,295.00	\$1,965.49
336320	TruckVault Inc.	T-TY4RUM1-99N	Toyota 4-Runner Mag 1 Dwr, dimensions: 36L x 39W	\$2,295.00	\$1,965.49
336320	TruckVault Inc.	T-TY4RUM1-99N-PT	Toyota 4-Runner Mag 1 Dwr, dimensions: 36L x 39W	\$2,990.00	\$2,560.71
336320	TruckVault Inc.	T-TY4RUM2-03M	Toyota 4-Runner Mag 2 Dwr, dimensions: 35L x 41W	\$2,645.00	\$2,265.24
336320	TruckVault Inc.	T-TY4RUM2-10N	Toyota 4-Runner Mag 2 Dwr, dimensions: 30.5L x 43W	\$2,645.00	\$2,265.24
336320	TruckVault Inc.	T-TY4RUM2-10N-HT	4-Runner Mag 2 Dwr	\$3,340.00	\$2,860.45
336320	TruckVault Inc.	T-TY4RUM2-10N-PG	Toyota 4-Runner Mag 2 Dwr, dimensions: 24L x 42.5W	\$2,645.00	\$2,265.24
336320	TruckVault Inc.	T-TY4RUM2-10N-T3	Toyota 4-Runner Mag 2 Dwr, dimensions: 31.75L x 41W	\$2,645.00	\$2,265.24
336320	TruckVault Inc.	T-TY4RUM2-90N	Toyota 4-Runner Mag 2 Dwr, dimensions: 36L x 36W	\$2,845.00	\$2,436.52
336320	TruckVault Inc.	T-TY4RUM2-96N	Toyota 4-Runner Mag 2 Dwr, dimensions: 36L x 39W	\$2,845.00	\$2,436.52
336320	TruckVault Inc.	T-TY4RUM2-99N	Toyota 4-Runner Mag 2 Dwr, dimensions: 36L x 39W	\$2,845.00	\$2,436.52
336320	TruckVault Inc.	T-TY4RUMO-03M	Toyota 4-Runner Mag Offset, dimensions: 35L x 41W	\$2,645.00	\$2,265.24
336320	TruckVault Inc.	T-TY4RUMO-10N	Toyota 4-Runner Mag Offset Dwr, dimensions: 30.5L x 43W	\$2,645.00	\$2,265.24
336320	TruckVault Inc.	T-TY4RUMO-10N-HT	4-Runner Mag Offset DwrHD Table	\$3,340.00	\$2,860.45
336320	TruckVault Inc.	T-TY4RUMO-10N-PG	Toyota 4-Runner Mag OS Dwr, dimensions: 24L x 42.5W	\$2,645.00	\$2,265.24
336320	TruckVault Inc.	T-TY4RUMO-10N-T3	4-Runner Mag Offset DwrFold 3rd Row Seating	\$2,645.00	\$2,265.24
336320	TruckVault Inc.	T-TY4RUMO-90N	Toyota 4-Runner Mag OS Dwr, dimensions: 0L x 0W	\$2,845.00	\$2,436.52
336320	TruckVault Inc.	T-TY4RUMO-96N	Toyota 4-Runner Mag OS Dwr, dimensions: 36L x 39W	\$2,845.00	\$2,436.52
336320	TruckVault Inc.	T-TY4RUMT-96N	Toyota 4-Runner Mag T Dwr, dimensions: 36L x 49W	\$2,295.00	\$1,965.49
336320	TruckVault Inc.	T-TY4RUN1-10N-ZC8594	4-Runner CUST 1 Dwr	\$1,995.00	\$1,708.56
336320	TruckVault Inc.	T-TY4RUN2-10N-ZC8468	4-Runner Custom 2 Dwr	\$2,325.00	\$1,991.18
336320	TruckVault Inc.	T-TY4RUS1-03M	Toyota 4-Runner Std 1 Dwr, dimensions: 37L x 41W	\$2,095.00	\$1,794.21
336320	TruckVault Inc.	T-TY4RUS1-03M-PT	Toyota 4-Runner Std 1 Dwr, dimensions: 36L x 41W	\$2,790.00	\$2,389.42
336320	TruckVault Inc.	T-TY4RUS1-03S	Toyota 4-Runner Std 1 Dwr, dimensions: 32.5L x 41W	\$1,895.00	\$1,622.92
336320	TruckVault Inc.	T-TY4RUS1-10N	Toyota 4-Runner Std 1 Dwr, dimensions: 33.75L x 41.5W	\$1,895.00	\$1,622.92
336320	TruckVault Inc.	T-TY4RUS1-10N-HT	4-Runner Std 1 Dwr	\$2,590.00	\$2,218.14
336320	TruckVault Inc.	T-TY4RUS1-10N-HT-PW-Z1	4-Runner Std 1 Dwr	\$2,535.00	\$2,171.03
336320	TruckVault Inc.	T-TY4RUS1-10N-PG	Toyota 4-Runner Std 1 Dwr, dimensions: 24L x 42.5W	\$1,895.00	\$1,622.92

336320	TruckVault Inc.	T-TY4RUS1-10N-PT	Toyota 4-Runner Std 1 Dwr, dimensions: 33L x 43W	\$2,590.00	\$2,218.14
336320	TruckVault Inc.	T-TY4RUS1-10N-RT	4-Runner Std 1 Dwr	\$1,895.00	\$1,622.92
336320	TruckVault Inc.	T-TY4RUS1-10N-RT-HT	4-Runner Std 1 Dwr	\$2,590.00	\$2,218.14
336320	TruckVault Inc.	T-TY4RUS1-10N-T3	Toyota 4-Runner Std 1 Dwr, dimensions: 34L x 43W	\$1,895.00	\$1,622.92
336320	TruckVault Inc.	T-TY4RUS1-84N	Toyota 4-Runner Std 1 Dwr, dimensions: 41L x 40W	\$2,095.00	\$1,794.21
336320	TruckVault Inc.	T-TY4RUS1-96N	Toyota 4-Runner Std 1 Dwr, dimensions: 38L x 37.5W	\$2,095.00	\$1,794.21
336320	TruckVault Inc.	T-TY4RUS1-99N	Toyota 4-Runner Std 1 Dwr, dimensions: 38L x 39W	\$2,095.00	\$1,794.21
336320	TruckVault Inc.	T-TY4RUS1-99N-PT	Toyota 4-Runner Std 1 Dwr, dimensions: 38L x 39W	\$2,790.00	\$2,389.42
336320	TruckVault Inc.	T-TY4RUS2-03M	Toyota 4-Runner Std 2 Dwr, dimensions: 37L x 41W	\$2,645.00	\$2,265.24
336320	TruckVault Inc.	T-TY4RUS2-03M-PT	Toyota 4-Runner Std 2 Dwr, dimensions: 36L x 41W	\$3,340.00	\$2,860.45
336320	TruckVault Inc.	T-TY4RUS2-03S	Toyota 4-Runner Std 2 Dwr, dimensions: 32.5L x 41W	\$2,445.00	\$2,093.95
336320	TruckVault Inc.	T-TY4RUS2-03S-PP	Toyota 4-Runner Std 2 Dwr, dimensions: 29.5L x 41W	\$2,445.00	\$2,093.95
336320	TruckVault Inc.	T-TY4RUS2-10N	Toyota 4-Runner Std 2 Dwr, dimensions: 33.75L x 41.5W	\$2,445.00	\$2,093.95
336320	TruckVault Inc.	T-TY4RUS2-10N-HT	4-Runner Std 2 Dwr	\$3,140.00	\$2,689.17
336320	TruckVault Inc.	T-TY4RUS2-10N-PG	Toyota 4-Runner Std 2 Dwr, dimensions: 24L x 42.5W	\$2,445.00	\$2,093.95
336320	TruckVault Inc.	T-TY4RUS2-10N-T3	Toyota 4-Runner Std 2 Dwr, dimensions: 34L x 43W	\$2,445.00	\$2,093.95
336320	TruckVault Inc.	T-TY4RUS2-10N-T3-HT	4-Runner Std 2 Dwr	\$3,140.00	\$2,689.17
336320	TruckVault Inc.	T-TY4RUS2-10N-ZC9728	4-Runner Std 2 Dwr	\$2,585.00	\$2,213.85
336320	TruckVault Inc.	T-TY4RUS2-84N	4-Runner Std 2 Dwr	\$2,645.00	\$2,265.24
336320	TruckVault Inc.	T-TY4RUS2-96N	Toyota 4-Runner Std 2 Dwr, dimensions: 38L x 37.5W	\$2,645.00	\$2,265.24
336320	TruckVault Inc.	T-TY4RUS2-99N	Toyota 4-Runner Std 2 Dwr, dimensions: 38L x 39W	\$2,645.00	\$2,265.24
336320	TruckVault Inc.	T-TY4RUSO-03M	Toyota 4-Runner Std OS Dwr, dimensions: 37L x 41W	\$2,645.00	\$2,265.24
336320	TruckVault Inc.	T-TY4RUSO-03M-PT	Toyota 4-Runner Std OS Dwr, dimensions: 36L x 41W	\$3,340.00	\$2,860.45
336320	TruckVault Inc.	T-TY4RUSO-10N	Toyota 4-Runner Std Offset Dwr, dimensions: 33.75L x 41.5W	\$2,445.00	\$2,093.95
336320	TruckVault Inc.	T-TY4RUSO-10N-HT	4-Runner Std OS Dwr	\$3,140.00	\$2,689.17
336320	TruckVault Inc.	T-TY4RUSO-10N-HT-RT	4-Runner Std OS DwrHD Table Ext	\$3,140.00	\$2,689.17
336320	TruckVault Inc.	T-TY4RUSO-10N-HT-TR-RT	4-Runner Std OS Dwr	\$3,140.00	\$2,689.17
336320	TruckVault Inc.	T-TY4RUSO-10N-PG	Toyota 4-Runner Std OS Dwr, dimensions: 24L x 42.5W	\$2,445.00	\$2,093.95
336320	TruckVault Inc.	T-TY4RUSO-10N-PT	4-Runner Std Offset Dwr	\$3,140.00	\$2,689.17
336320	TruckVault Inc.	T-TY4RUSO-10N-RT	4-Runner Std Offset Dwr	\$2,445.00	\$2,093.95
336320	TruckVault Inc.	T-TY4RUSO-96N	Toyota 4-Runner Std OS Dwr, dimensions: 38L x 37.5W	\$2,645.00	\$2,265.24
336320	TruckVault Inc.	T-TY4RUSO-99N	Toyota 4-Runner Std OS Dwr, dimensions: 38L x 39W	\$2,645.00	\$2,265.24
336320	TruckVault Inc.	T-TY4RUST-90N	Toyota 4-Runner Std T Dwr, dimensions: 40L x 47.5W	\$2,095.00	\$1,794.21
336320	TruckVault Inc.	T-TY4RUST-99N	Toyota 4-Runner Std T Dwr, dimensions: 38L x 49W	\$2,095.00	\$1,794.21
336320	TruckVault Inc.	T-TY4RUU1-03M	4-Runner Utility 1 Dwr	\$2,195.00	\$1,879.85
336320	TruckVault Inc.	T-TY4RUU1-03M-HT	4-Runner Std 1 Dwr	\$2,690.00	\$2,303.78
336320	TruckVault Inc.	T-TY4RUU1-10N	4-Runner Utility 1 Dwr	\$1,995.00	\$1,708.56
336320	TruckVault Inc.	T-TY4RUU1-10N-HP	4-Runner Utility 1 Dwr1/2 Width Passenger Side	\$1,595.00	\$1,365.99
336320	TruckVault Inc.	T-TY4RUU1-10N-HT	4-Runner Utility 1 Dwr	\$2,690.00	\$2,303.78
336320	TruckVault Inc.	T-TY4RUU1-10N-PG-HT	4-Runner Utility 1 Dwr	\$2,490.00	\$2,132.49
336320	TruckVault Inc.	T-TY4RUU1-10N-RT-HT	4-Runner Utility 1 DwrHD Table Tray Removed	\$2,690.00	\$2,303.78
336320	TruckVault Inc.	T-TY4RUU1-10N-T3	4-Runner Utility 1 Dwr	\$1,995.00	\$1,708.56
336320	TruckVault Inc.	T-TY4RUU1-10N-T3-HT	4-Runner Utility 1 DwrHD Table, Seat Folded	\$2,690.00	\$2,303.78
336320	TruckVault Inc.	T-TY4RUU1-10N-TR	4-Runner Utility 1 Dwr	\$1,995.00	\$1,708.56
336320	TruckVault Inc.	T-TY4RUU2-03M	4-Runner Utility 2 Dwr	\$2,745.00	\$2,350.88
336320	TruckVault Inc.	T-TY4RUU2-10N	4-Runner Utility 2 Dwr	\$2,545.00	\$2,179.60
336320	TruckVault Inc.	T-TY4RUU2-10N-HT	4-Runner Utility 2 DwrHeavy Duty Table	\$3,240.00	\$2,774.81
336320	TruckVault Inc.	T-TY4RUU2-10N-HT-RT	4-Runner Utility 2 Dwr	\$3,240.00	\$2,774.81
336320	TruckVault Inc.	T-TY4RUUO-10N	4-Runner Utility Offset Dwr	\$2,545.00	\$2,179.60
336320	TruckVault Inc.	T-TY4RUUO-10N-HT	4-Runner Utility Offset Dwr	\$3,240.00	\$2,774.81
336320	TruckVault Inc.	T-TY4RUUO-90N	4-Runner Utility OS Dwr	\$2,745.00	\$2,350.88
336320	TruckVault Inc.	T-TYFJCM1-07N	Toyota FJ Cruiser Mag 1 Dwr, dimensions: 27L x 40W	\$2,095.00	\$1,794.21
336320	TruckVault Inc.	T-TYFJCM1-07N-HT	FJ Cruiser Mag 1 Dwr	\$2,790.00	\$2,389.42
336320	TruckVault Inc.	T-TYFJCM1-07N-PT	Toyota FJ Cruiser Mag 1 Dwr, dimensions: 25.5L x 40W	\$2,790.00	\$2,389.42
336320	TruckVault Inc.	T-TYFJCM2-07N	Toyota FJ Cruiser Mag 2 Dwr, dimensions: 27L x 40.125W	\$2,645.00	\$2,265.24
336320	TruckVault Inc.	T-TYFJCM2-07N-HT	FJ Cruiser Mag 2 Dwr	\$3,340.00	\$2,860.45
336320	TruckVault Inc.	T-TYFJCM2-07N-PT	Toyota FJ Cruiser Mag 2 Dwr, dimensions: 25.5L x 40W	\$3,340.00	\$2,860.45
336320	TruckVault Inc.	T-TYFJCMO-07N	Toyota FJ Cruiser Mag OS Dwr, dimensions: 27L x 40W	\$2,645.00	\$2,265.24
336320	TruckVault Inc.	T-TYFJCMO-07N-PT	Toyota FJ Cruiser Mag OS Dwr, dimensions: 25.5L x 40W	\$3,340.00	\$2,860.45
336320	TruckVault Inc.	T-TYFJCS1-07N	Toyota FJ Cruiser Std 1 Dwr, dimensions: 30L x 39.5W	\$1,895.00	\$1,622.92
336320	TruckVault Inc.	T-TYFJCS1-07N-HT	FJ Cruiser Std 1 Dwr	\$2,590.00	\$2,218.14
336320	TruckVault Inc.	T-TYFJCS1-07N-PT	Toyota FJ Cruiser Std 1 Dwr, dimensions: 28.5L x 39.5W	\$2,590.00	\$2,218.14
336320	TruckVault Inc.	T-TYFJCS2-07N	Toyota FJ Cruiser Std 2 Dwr, dimensions: 30L x 39.5W	\$2,445.00	\$2,093.95
336320	TruckVault Inc.	T-TYFJCS2-07N-HT	FJ Cruiser Std 2 Dwr	\$3,140.00	\$2,689.17
336320	TruckVault Inc.	T-TYFJCS2-07N-PT	Toyota FJ Cruiser Std 2 Dwr, dimensions: 28.5L x 39.5W	\$3,140.00	\$2,689.17
336320	TruckVault Inc.	T-TYFJCSO-07N	Toyota FJ Cruiser Std OS Dwr, dimensions: 30L x 39.5W	\$2,445.00	\$2,093.95



336320	TruckVault Inc.	T-TYFJCSO-07N-PT	Toyota FJ Cruiser Std OS Dwr, dimensions: 28.5L x 39.5W	\$3,140.00	\$2,689.17
336320	TruckVault Inc.	T-TYFJCU1-07N	FJ Cruiser Utility 1 Dwr	\$1,995.00	\$1,708.56
336320	TruckVault Inc.	T-TYFJCU2-07N	FJ Cruiser Utility 2 Dwr	\$2,545.00	\$2,179.60
336320	TruckVault Inc.	T-TYFJCUO-07N	FJ Cruiser Utility OS Dwr	\$2,545.00	\$2,179.60
336320	TruckVault Inc.	T-TYFJCUO-07N-ZC8947	FJ Cruiser Utility OS Dwr	\$2,485.00	\$2,128.21
336320	TruckVault Inc.	T-TYFORM2-16N	Fortuner Mag 2 Dwr	\$2,845.00	\$2,436.52
336320	TruckVault Inc.	T-TYHILM2-15S-PC-ZC10884	Tacoma Hilux Pickup5' Short Bed No Wings	\$3,065.00	\$2,624.94
336320	TruckVault Inc.	T-TYHILS2-05S-PC	Tacoma Hilux Pickup	\$2,945.00	\$2,522.17
336320	TruckVault Inc.	T-TYHLNM1-01N	Toyota Highlander Mag 1 Dwr, dimensions: 30.5L x 38W	\$2,095.00	\$1,794.21
336320	TruckVault Inc.	T-TYHLNM1-04N	Toyota Highlander Mag 1 Dwr, dimensions: 32L x 38W	\$2,095.00	\$1,794.21
336320	TruckVault Inc.	T-TYHLNM1-08N	Toyota Highlander Mag 1 Dwr, dimensions: 31L x 41W	\$2,095.00	\$1,794.21
336320	TruckVault Inc.	T-TYHLNM1-14N	Toyota Highlander Mag 1 Dwr, dimensions: 31L x 44.5W	\$2,095.00	\$1,794.21
336320	TruckVault Inc.	T-TYHLNM1-20N	Highlander Mag1 Drawer3rd Row Folded; Hybrid and Non-Hybrid	\$2,295.00	\$1,965.49
336320	TruckVault Inc.	T-TYHLNM1-20N-HG	Highlander Mag 1 DwrElevated Version	\$2,185.00	\$1,871.28
336320	TruckVault Inc.	T-TYHLNM2-01N	Toyota Highlander Mag 2 Dwr, dimensions: 33L x 38W	\$2,645.00	\$2,265.24
336320	TruckVault Inc.	T-TYHLNM2-04N	Toyota Highlander Mag 2 Dwr, dimensions: 30.5L x 38W	\$2,645.00	\$2,265.24
336320	TruckVault Inc.	T-TYHLNM2-08N	Toyota Highlander Mag 2 Dwr, dimensions: 31L x 41W	\$2,645.00	\$2,265.24
336320	TruckVault Inc.	T-TYHLNM2-08N-PT	Toyota Highlander Mag 2 Dwr, dimensions: 30L x 41W	\$3,340.00	\$2,860.45
336320	TruckVault Inc.	T-TYHLNM2-14N	Highlander Mag 2 Dwr	\$2,645.00	\$2,265.24
336320	TruckVault Inc.	T-TYHLNMO-14N	Highlander Mag Offset Dwr	\$2,645.00	\$2,265.24
336320	TruckVault Inc.	T-TYHLNS1-01N	Toyota Highlander Std 1 Dwr, dimensions: 33L x 38W	\$1,895.00	\$1,622.92
336320	TruckVault Inc.	T-TYHLNS1-04N	Toyota Highlander Std 1 Dwr, dimensions: 33L x 39.25W	\$1,895.00	\$1,622.92
336320	TruckVault Inc.	T-TYHLNS1-08N	Toyota Highlander Std 1 Dwr, dimensions: 36L x 41W	\$1,895.00	\$1,622.92
336320	TruckVault Inc.	T-TYHLNS1-08S	Highlander Std 1 Dwr	\$1,695.00	\$1,451.64
336320	TruckVault Inc.	T-TYHLNS1-14N	Toyota Highlander Std 1 Drawer, dimensions: 33L x 44.5W	\$1,895.00	\$1,622.92
336320	TruckVault Inc.	T-TYHLNS1-14N-HG	Highlander Std 1 DwrElevated Version	\$1,965.00	\$1,682.87
336320	TruckVault Inc.	T-TYHLNS1-14S	Highlander Std 1 DwrBehind 3rd Row Seat	\$1,695.00	\$1,451.64
336320	TruckVault Inc.	T-TYHLNS1-20N-HG	Highlander Std 1 DwrElevated Version	\$1,965.00	\$1,682.87
336320	TruckVault Inc.	T-TYHLNS1-20S	Highlander Std 1 DwrBehind 3rd Row Seat	\$1,695.00	\$1,451.64
336320	TruckVault Inc.	T-TYHLNS2-01N	Toyota Highlander Std 2 Dwr, dimensions: 33L x 38W	\$2,445.00	\$2,093.95
336320	TruckVault Inc.	T-TYHLNS2-04N	Toyota Highlander Std 2 Dwr, dimensions: 33L x 39.25W	\$2,445.00	\$2,093.95
336320	TruckVault Inc.	T-TYHLNS2-08N	Toyota Highlander Std 2 Dwr, dimensions: 36L x 41W	\$2,645.00	\$2,265.24
336320	TruckVault Inc.	T-TYHLNS2-14N	Highlander Std 2 Dwr	\$2,445.00	\$2,093.95
336320	TruckVault Inc.	T-TYHLNS2-20N-HT	Highlander Std 2 Dwr HD Table	\$3,340.00	\$2,860.45
336320	TruckVault Inc.	T-TYHLNSO-01N	Toyota Highlander Std Offset Dwr, dimensions: 33L x 38W	\$2,445.00	\$2,093.95
336320	TruckVault Inc.	T-TYHLNU1-01N	Highlander Utility 1 Dwr	\$1,995.00	\$1,708.56
336320	TruckVault Inc.	T-TYHLNU1-14N	Highlander Utility 1 Drawer	\$1,995.00	\$1,708.56
336320	TruckVault Inc.	T-TYHLNU1-14N-HG	Highlander Utility 1 DwrElevated Version	\$1,995.00	\$1,708.56
336320	TruckVault Inc.	T-TYHLNU1-20N	Highlander Utility 1 Drawer3rd Row Folded; Hybrid and Non-Hybrid	\$2,195.00	\$1,879.85
336320	TruckVault Inc.	T-TYHLNU1-20N-HG	Highlander Utility 1 DwrElevated Version	\$2,075.00	\$1,777.08
336320	TruckVault Inc.	T-TYHLNU1-20S	Highlander Utility 1 Dwr	\$1,725.00	\$1,477.33
336320	TruckVault Inc.	T-TYHLNU2-04N-HT	Highlander Utility 2 Dwr3rd Row Folded; HD Table	\$3,240.00	\$2,774.81
336320	TruckVault Inc.	T-TYHLNU2-08N	Highlander Utility 2 Dwr3rd Row Folded;	\$2,545.00	\$2,179.60
336320	TruckVault Inc.	T-TYHLNU2-14N-PT	Highlander Utility 2 Dwr, Table3rd Row Folded; Hybrid and Non-Hybrid	\$3,240.00	\$2,774.81
336320	TruckVault Inc.	T-TYHLNU2-20N	Highlander Utility 2 Dwr3rd Row Folded; Hybrid and Non-Hybrid	\$2,745.00	\$2,350.88
336320	TruckVault Inc.	T-TYHLNUO-14N	Highlander Utility OS Dwr	\$2,545.00	\$2,179.60
336320	TruckVault Inc.	T-TYHLXMO-05S-PC-PW	Hilux Pickup Mag 2 Drawer	\$3,945.00	\$3,378.59
336320	TruckVault Inc.	T-TYHLXMO-05S-PC-PW	Hilux Pickup Mag OS Drawer	\$3,945.00	\$3,378.59
336320	TruckVault Inc.	T-TYHLXS2-05S-PC-PW	Toyota Hilux Pickup Std 2 Drawer, dimensions: 59L x 42.5W	\$3,745.00	\$3,207.30
336320	TruckVault Inc.	T-TYHLXUO-05S-PC-PW	Hilux Pickup Utility 2 Dwr Offset	\$3,845.00	\$3,292.95
336320	TruckVault Inc.	T-TYLDCM1-08N	Toyota Land Cruiser Mag 1 Dwr, dimensions: 40L x 39W	\$2,295.00	\$1,965.49
336320	TruckVault Inc.	T-TYLDCM1-08N-HT-NT	Land Cruiser Mag 1 DwrHD Table Extension	\$2,990.00	\$2,560.71
336320	TruckVault Inc.	T-TYLDCM1-08N-TR	Toyota Landcruiser Mag 1 Dwr, dimensions: 38L x 40W	\$2,295.00	\$1,965.49
336320	TruckVault Inc.	T-TYLDCM1-08N-TR-ZC9503	Landcruiser Mag 1 Dwr	\$2,625.00	\$2,248.11
336320	TruckVault Inc.	T-TYLDCM1-80N	Land Cruiser Mag 1 Dwr	\$2,295.00	\$1,965.49
336320	TruckVault Inc.	T-TYLDCM1-91N	Toyota Land Cruiser Mag 1 Dwr, dimensions: 39L x 42.375W	\$2,295.00	\$1,965.49
336320	TruckVault Inc.	T-TYLDCM1-98N	Toyota Land Cruiser Mag 1 Dwr, dimensions: 39L x 42.5W	\$2,295.00	\$1,965.49
336320	TruckVault Inc.	T-TYLDCM1-98N-TR	Landcruiser Mag 1 Dwr3rd Row Seats Removed	\$2,295.00	\$1,965.49
336320	TruckVault Inc.	T-TYLDCM2-08N	Toyota Land Cruiser Mag 2 Dwr, dimensions: 38L x 39W	\$2,845.00	\$2,436.52
336320	TruckVault Inc.	T-TYLDCM2-08N-TR	Toyota Land Cruiser Mag 2 Dwr, dimensions: 38L x 40W	\$2,845.00	\$2,436.52
336320	TruckVault Inc.	T-TYLDCM2-80N	Land Cruiser Mag 2 Dwr	\$2,845.00	\$2,436.52
336320	TruckVault Inc.	T-TYLDCM2-91N	Toyota Land Cruiser Mag 2 Dwr, dimensions: 39L x 43W	\$2,845.00	\$2,436.52
336320	TruckVault Inc.	T-TYLDCM2-91N-HT	Land Cruiser Mag 2 Dwr	\$3,540.00	\$3,031.74
336320	TruckVault Inc.	T-TYLDCM2-98N	Toyota Land Cruiser Mag 2 Dwr, dimensions: 39L x 42.5W	\$2,845.00	\$2,436.52

336320	TruckVault Inc.	T-TYLDCCMO-08N-TR	Toyota Land Cruiser Mag Offset, dimensions: 38L x 40W	\$2,845.00	\$2,436.52
336320	TruckVault Inc.	T-TYLDCCMT-91N	Toyota Land Cruiser Mag T Dwr, dimensions: 37L x 52.5W	\$2,295.00	\$1,965.49
336320	TruckVault Inc.	T-TYLDCCS1-08N	Toyota Land Cruiser Std 1 Dwr, dimensions: 40L x 39W	\$2,095.00	\$1,794.21
336320	TruckVault Inc.	T-TYLDCCS1-08N-NT	Land Cruiser Std 1 DwrNever Had 3rd Row	\$2,095.00	\$1,794.21
336320	TruckVault Inc.	T-TYLDCCS1-08N-NT-PT	Land Cruiser Std 1 Dwr	\$2,790.00	\$2,389.42
336320	TruckVault Inc.	T-TYLDCCS1-08N-TR	Toyota Land Cruiser Std 1 Dwr, dimensions: 40L x 40W	\$2,095.00	\$1,794.21
336320	TruckVault Inc.	T-TYLDCCS1-08N-TR-PT	Land Cruiser Std 1 Dwr	\$2,790.00	\$2,389.42
336320	TruckVault Inc.	T-TYLDCCS1-08N-TT	Land Cruiser Std 1 Dwr	\$2,975.00	\$2,547.86
336320	TruckVault Inc.	T-TYLDCCS1-80N	Toyota Land Cruiser Std 1 Dwr, dimensions: 41L x 41W	\$2,095.00	\$1,794.21
336320	TruckVault Inc.	T-TYLDCCS1-91N	Toyota Land Cruiser Std 1 Dwr, dimensions: 42L x 43W	\$2,095.00	\$1,794.21
336320	TruckVault Inc.	T-TYLDCCS1-91N-PT	Toyota Land Cruiser Std 1 Dwr, dimensions: 42L x 43W	\$2,790.00	\$2,389.42
336320	TruckVault Inc.	T-TYLDCCS1-98N	Toyota Land Cruiser Std 1 Dwr, dimensions: 40L x 42.5W	\$2,095.00	\$1,794.21
336320	TruckVault Inc.	T-TYLDCCS1-98N-TR-PT	Land Cruiser Std 1 Dwr3rd Row Removed	\$2,790.00	\$2,389.42
336320	TruckVault Inc.	T-TYLDCCS2-08N	Toyota Land Cruiser Std 2 Dwr, dimensions: 40L x 39W	\$2,645.00	\$2,265.24
336320	TruckVault Inc.	T-TYLDCCS2-08N-NT	Land Cruiser Std 2 DwrNever Had 3rd Row	\$2,645.00	\$2,265.24
336320	TruckVault Inc.	T-TYLDCCS2-08N-TR	Toyota Land Cruiser Std 2 Dwr, dimensions: 40L x 40W	\$2,645.00	\$2,265.24
336320	TruckVault Inc.	T-TYLDCCS2-08N-TT	Toyota Land Cruiser Std 2 Dwr, dimensions: 40L x 39W	\$3,525.00	\$3,018.89
336320	TruckVault Inc.	T-TYLDCCS2-80N	Toyota Land Cruiser Std 2 Dwr, dimensions: 40L x 42.5W	\$2,645.00	\$2,265.24
336320	TruckVault Inc.	T-TYLDCCS2-80N-PT	Toyota Land Cruiser Std 2 Dwr, dimensions: 41L x 41W	\$3,340.00	\$2,860.45
336320	TruckVault Inc.	T-TYLDCCS2-91N	Toyota Land Cruiser Std 2 Dwr, dimensions: 42L x 43W	\$2,645.00	\$2,265.24
336320	TruckVault Inc.	T-TYLDCCS2-98N	Toyota Land Cruiser Std 2 Dwr, dimensions: 40L x 42.5W	\$2,645.00	\$2,265.24
336320	TruckVault Inc.	T-TYLDCCS2-98N-PT	Toyota Land Cruiser Std 2 Dwr, dimensions: 39L x 42.5W	\$3,340.00	\$2,860.45
336320	TruckVault Inc.	T-TYLDCCS2-98N-TR	Land Cruiser Std 2 Dwr	\$2,645.00	\$2,265.24
336320	TruckVault Inc.	T-TYLDCCSO-08N	Toyota Land Cruiser Std Offset Dwr, dimensions: 40L x 39W	\$2,645.00	\$2,265.24
336320	TruckVault Inc.	T-TYLDCCSO-08N-TR	Toyota Land Cruiser Std Offset Dwr, dimensions: 40L x 40W	\$2,645.00	\$2,265.24
336320	TruckVault Inc.	T-TYLDCCSO-98N	Toyota Land Cruiser Std OS Dwr, dimensions: 40L x 42.5W	\$2,645.00	\$2,265.24
336320	TruckVault Inc.	T-TYLDCCSO-98N-PT-TR	Land Cruiser Std OS Dwr	\$3,340.00	\$2,860.45
336320	TruckVault Inc.	T-TYLDCCSO-98N-TR	Land Cruiser Std OS Dwr3rd Seat Removed	\$2,645.00	\$2,265.24
336320	TruckVault Inc.	T-TYLDCCST-08N-TR	Toyota Land Cruiser Std 1 Dwr, dimensions: 40L x 48W	\$2,095.00	\$1,794.21
336320	TruckVault Inc.	T-TYLDCCST-91N	Toyota Land Cruiser Std T Dwr, dimensions: 39L x 52.5W	\$2,095.00	\$1,794.21
336320	TruckVault Inc.	T-TYLDCCU1-08N	Land Cruiser Utility 1 Dwr	\$2,195.00	\$1,879.85
336320	TruckVault Inc.	T-TYLDCCU1-08N-NT	Land Cruiser Utility 1 Dwr3rd Row Never Had	\$2,195.00	\$1,879.85
336320	TruckVault Inc.	T-TYLDCCU1-08N-TR	Land Cruiser Utility 1 Dwr	\$2,195.00	\$1,879.85
336320	TruckVault Inc.	T-TYLDCCU1-08S	Land Cruiser Utility 1 Dwr	\$1,795.00	\$1,537.28
336320	TruckVault Inc.	T-TYLDCCU1-80N	Land Cruiser Utility 1 Dwr	\$2,195.00	\$1,879.85
336320	TruckVault Inc.	T-TYLDCCU1-98N-TR-PT	Land Cruiser Utility 1 Dwr3rd Row Removed; Table Extension	\$2,890.00	\$2,475.06
336320	TruckVault Inc.	T-TYLDCCU2-08N-TR	Land Cruiser Utility 2 Dwr3rd Row Removed	\$2,745.00	\$2,350.88
336320	TruckVault Inc.	T-TYLDCCU2-80N	Land Cruiser Utility 2 Dwr	\$2,745.00	\$2,350.88
336320	TruckVault Inc.	T-TYLDCCU2-98N-TR	Land Cruiser Utility 2 Dwr	\$2,745.00	\$2,350.88
336320	TruckVault Inc.	T-TYLDCCUO-08N	Land Cruiser Utility OS Dwr	\$2,745.00	\$2,350.88
336320	TruckVault Inc.	T-TYLDCCUO-08N-TR	Land Cruiser Utility 2 Dwr Offset	\$2,625.00	\$2,248.11
336320	TruckVault Inc.	T-TYMATM1-03N	Toyota Matrix Mag 1 Dwr, dimensions: 0L x 0W	\$1,895.00	\$1,622.92
336320	TruckVault Inc.	T-TYMATM2-03N	Toyota Matrix Mag 2 Dwr, dimensions: 0L x 0W	\$2,645.00	\$2,265.24
336320	TruckVault Inc.	T-TYMATS1-03N	Toyota Matrix Std 1 Dwr, dimensions: 0L x 0W	\$1,695.00	\$1,451.64
336320	TruckVault Inc.	T-TYMATS2-03N	Toyota Matrix Std 2 Dwr, dimensions: 0L x 0W	\$2,245.00	\$1,922.67
336320	TruckVault Inc.	T-TYPICM1-88S-HD	Toyota Pickup Mag 1 Dwr1/2 Width Driver's Side	\$2,395.00	\$2,051.13
336320	TruckVault Inc.	T-TYPICM1-88S-HP	T-100 Mag 1 Dwr Half Width6' Bed, Passenger Side	\$2,545.00	\$2,179.60
336320	TruckVault Inc.	T-TYPICM2-88S	Toyota Pickup Mag 2 Dwr	\$3,345.00	\$2,864.74
336320	TruckVault Inc.	T-TYPICS2-83S	Toyota Pickup Std 2 Dwr	\$3,145.00	\$2,693.45
336320	TruckVault Inc.	T-TYPICS2-88S	Toyota Pickup Std 2 Dwr	\$3,145.00	\$2,693.45
336320	TruckVault Inc.	T-TYPICS2-88S-PW	Toyota Pickup Std 2 Dwr	\$3,975.00	\$3,404.28
336320	TruckVault Inc.	T-TYPICUO-88S-PW	Toyota Pickup Utility 2 Dwr Offset6' All Weather	\$4,445.00	\$3,806.80
336320	TruckVault Inc.	T-TYPRAM2-10N	Prado Mag 2 Dwr	\$2,645.00	\$2,265.24
336320	TruckVault Inc.	T-TYPRSL3-10N-ZC8038	Prius Cust 3 Lids	\$2,025.00	\$1,734.26
336320	TruckVault Inc.	T-TYPRSM1-04N	Toyota Prius Mag 1 Dwr, dimensions: 0L x 0W	\$1,695.00	\$1,451.64
336320	TruckVault Inc.	T-TYPRSM1-10N	Prius Mag 1 Dwr	\$2,095.00	\$1,794.21
336320	TruckVault Inc.	T-TYPRSM2-04N	Toyota Prius Mag 2 Dwr, dimensions: 0L x 0W	\$2,445.00	\$2,093.95
336320	TruckVault Inc.	T-TYPRSM2-10N	Prius Mag 2 Dwr	\$2,645.00	\$2,265.24
336320	TruckVault Inc.	T-TYPRSMO-10N	Prius Mag OS Dwr	\$2,645.00	\$2,265.24
336320	TruckVault Inc.	T-TYPRSS1-04N	Toyota Prius Std 1 Dwr, dimensions: 26L x 35W	\$1,695.00	\$1,451.64
336320	TruckVault Inc.	T-TYPRSS1-09N	Toyota Prius Std 1 Dwr, dimensions: 0L x 0W	\$1,895.00	\$1,622.92
336320	TruckVault Inc.	T-TYPRSS1-10N	Toyota Prius Std 1 Dwr, dimensions: 26L x 37.5W	\$1,895.00	\$1,622.92
336320	TruckVault Inc.	T-TYPRSS2-04N	Toyota Prius Std 2 Dwr, dimensions: 26L x 35W	\$2,245.00	\$1,922.67
336320	TruckVault Inc.	T-TYPRSU1-10N	Prius Utility 1 Dwr	\$1,795.00	\$1,537.28
336320	TruckVault Inc.	T-TYRAVM1-01N	Rav 4 Mag 1 Dwr	\$1,695.00	\$1,451.64
336320	TruckVault Inc.	T-TYRAVM1-06N	Toyota Rav 4 Mag 1 Dwr, dimensions: 32L x 43.5W	\$2,095.00	\$1,794.21

336320	TruckVault Inc.	T-TYRAVM1-13N	Rav 4 Mag 1 Dwr	\$2,095.00	\$1,794.21
336320	TruckVault Inc.	T-TYRAVM1-18N	Rav 4 Mag 1 Dwr	\$2,095.00	\$1,794.21
336320	TruckVault Inc.	T-TYRAVM1-18N-ZC9016	Rav 4 Custom	\$1,805.00	\$1,545.84
336320	TruckVault Inc.	T-TYRAVM2-13N	Toyota Rav 4 Mag 2 Dwr, dimensions: 25L x 42W	\$2,645.00	\$2,265.24
336320	TruckVault Inc.	T-TYRAVM2-13N-PH	Rav 4 Mag 2 Dwr	\$2,645.00	\$2,265.24
336320	TruckVault Inc.	T-TYRAVM2-18N	Rav 4 Mag 2 Dwr	\$2,525.00	\$2,162.47
336320	TruckVault Inc.	T-TYRAVM2-18N-PT	Rav 4 Mag 2 Dwr	\$3,340.00	\$2,860.45
336320	TruckVault Inc.	T-TYRAVS1-06N	Toyota Rav 4 Std 1 Dwr, dimensions: 34L x 43.5W	\$1,895.00	\$1,622.92
336320	TruckVault Inc.	T-TYRAVS1-13N	Rav 4 Std 1 Dwr	\$1,895.00	\$1,622.92
336320	TruckVault Inc.	T-TYRAVS1-13N-PH	Rav 4 Std 1 Dwr	\$1,695.00	\$1,451.64
336320	TruckVault Inc.	T-TYRAVS1-18N	Rav 4 Std 1 Dwr	\$1,895.00	\$1,622.92
336320	TruckVault Inc.	T-TYRAVS2-06N	Toyota Rav 4 Std 2 Dwr, dimensions: 34L x 43.5W	\$2,445.00	\$2,093.95
336320	TruckVault Inc.	T-TYRAVS2-06N-PT	Toyota Rav 4 Std 2 Dwr, dimensions: 33L x 43.5W	\$3,140.00	\$2,689.17
336320	TruckVault Inc.	T-TYRAVS2-13N	Toyota Rav 4 Std 2 Dwr, dimensions: 27L x 42W	\$2,445.00	\$2,093.95
336320	TruckVault Inc.	T-TYRAVS2-18N	Rav 4 Std 2 Dwr	\$2,445.00	\$2,093.95
336320	TruckVault Inc.	T-TYRAVS2-94N	Rav 4 Std 2 Dwr	\$2,245.00	\$1,922.67
336320	TruckVault Inc.	T-TYRAVSO-18N	Rav 4 Std Offset Dwr	\$2,445.00	\$2,093.95
336320	TruckVault Inc.	T-TYRAVU1-06N	Rav 4 Utility 1 Dwr	\$1,995.00	\$1,708.56
336320	TruckVault Inc.	T-TYRAVU1-18N	Rav 4 Utility 1 Dwr	\$1,995.00	\$1,708.56
336320	TruckVault Inc.	T-TYRAVU2-18N	Rav 4 Utility 2 Dwr	\$2,545.00	\$2,179.60
336320	TruckVault Inc.	T-TYRAVU2-18N-PT	Rav 4 Utility 2 Dwr	\$3,240.00	\$2,774.81
336320	TruckVault Inc.	T-TYSEQM1-01N-TF	Toyota Sequoia Mag 1 Dwr, dimensions: 31L x 48W	\$2,095.00	\$1,794.21
336320	TruckVault Inc.	T-TYSEQM1-01N-TR	Toyota Sequoia Mag 1 Dwr, dimensions: 49L x 48W	\$2,295.00	\$1,965.49
336320	TruckVault Inc.	T-TYSEQM1-08N-TF	Toyota Sequoia Mag 1 Dwr, dimensions: 44L x 48W	\$2,295.00	\$1,965.49
336320	TruckVault Inc.	T-TYSEQM1-08N-TR	Toyota Sequoia Mag 1 Dwr, dimensions: 46L x 48W	\$2,295.00	\$1,965.49
336320	TruckVault Inc.	T-TYSEQM1-08S	Sequoia Mag 1 Dwr	\$1,895.00	\$1,622.92
336320	TruckVault Inc.	T-TYSEQM2-01N-TF	Toyota Sequoia Mag 2 Dwr, dimensions: 31L x 48W	\$2,645.00	\$2,265.24
336320	TruckVault Inc.	T-TYSEQM2-01N-TF-PT	Toyota Sequoia Mag 2 Dwr, dimensions: 30L x 48W	\$3,340.00	\$2,860.45
336320	TruckVault Inc.	T-TYSEQM2-01N-TR	Toyota Sequoia Mag 2 Dwr, dimensions: 49L x 48W	\$2,985.00	\$2,556.42
336320	TruckVault Inc.	T-TYSEQM2-01N-TR-PT	Toyota Sequoia Mag 2 Dwr, dimensions: 48L x 48W	\$3,685.00	\$3,155.92
336320	TruckVault Inc.	T-TYSEQM2-08N-TF	Toyota Sequoia Mag 2 Dwr, dimensions: 44L x 48W	\$2,845.00	\$2,436.52
336320	TruckVault Inc.	T-TYSEQM2-08N-TF-PT	Toyota Sequoia Mag 2 Dwr, dimensions: 42L x 48W	\$3,540.00	\$3,031.74
336320	TruckVault Inc.	T-TYSEQMO-01N-TF	Toyota Sequoia Mag Offset, dimensions: 31L x 48W	\$2,645.00	\$2,265.24
336320	TruckVault Inc.	T-TYSEQMO-01N-TR	Toyota Sequoia Mag Offset, dimensions: 49L x 48W	\$2,985.00	\$2,556.42
336320	TruckVault Inc.	T-TYSEQMO-08N-TF	Toyota Sequoia Mag Offset, dimensions: 44L x 48W	\$2,845.00	\$2,436.52
336320	TruckVault Inc.	T-TYSEQS1-01N-TF	Toyota Sequoia Std 1 Dwr, dimensions: 34L x 48W	\$1,895.00	\$1,622.92
336320	TruckVault Inc.	T-TYSEQS1-01N-TF-PT	Toyota Sequoia Std 1 Dwr, dimensions: 34L x 48W	\$2,590.00	\$2,218.14
336320	TruckVault Inc.	T-TYSEQS1-01N-TR	Toyota Sequoia Std 1 Dwr, dimensions: 46L x 48W	\$2,095.00	\$1,794.21
336320	TruckVault Inc.	T-TYSEQS1-01S	Toyota Sequoia Std 1 Dwr, dimensions: 34L x 48W	\$1,895.00	\$1,622.92
336320	TruckVault Inc.	T-TYSEQS1-08N-TF	Toyota Sequoia Std 1 Dwr, dimensions: 46L x 48W	\$2,095.00	\$1,794.21
336320	TruckVault Inc.	T-TYSEQS2-01N-TF	Toyota Sequoia Std 2 Dwr, dimensions: 34L x 48W	\$2,445.00	\$2,093.95
336320	TruckVault Inc.	T-TYSEQS2-01N-TR	Toyota Sequoia Std 2 Dwr, dimensions: 51L x 48W	\$2,645.00	\$2,265.24
336320	TruckVault Inc.	T-TYSEQS2-01N-TR-PT	Toyota Sequoia Std 2 Dwr, dimensions: 51L x 48W	\$3,465.00	\$2,967.51
336320	TruckVault Inc.	T-TYSEQS2-08N-TF	Toyota Sequoia Std 2 Dwr, dimensions: 46L x 48W	\$2,645.00	\$2,265.24
336320	TruckVault Inc.	T-TYSEQS2-08N-TR	Toyota Sequoia Std 2 Dwr, dimensions: 51L x 48W	\$2,755.00	\$2,359.45
336320	TruckVault Inc.	T-TYSEQSO-01N-TR	Sequoia Std O/S Dwr	\$2,645.00	\$2,265.24
336320	TruckVault Inc.	T-TYSEQSO-08N-TF	Toyota Sequoia Std OS Dwr, dimensions: 46L x 48W	\$2,645.00	\$2,265.24
336320	TruckVault Inc.	T-TYSEQU1-01N-TR	Sequoia Utility1 Dwr	\$2,195.00	\$1,879.85
336320	TruckVault Inc.	T-TYSEQU2-01N-TR	Sequoia Utility 2 Dwr	\$2,745.00	\$2,350.88
336320	TruckVault Inc.	T-TYSEQU2-08N-TF	Sequoia Utility 2 Dwr	\$2,745.00	\$2,350.88
336320	TruckVault Inc.	T-TYSEQU2-08N-TF-HT	Sequoia Utility 2 DwrSeat Folded HD Table	\$3,440.00	\$2,946.10
336320	TruckVault Inc.	T-TYSEQU2-08N-TF-TT	Sequoia Utility 2 Dwr	\$3,635.00	\$3,113.10
336320	TruckVault Inc.	T-TYSEQU2-08N-TF-TT-ZC9604	Sequoia Utility 2 Dwr	\$4,635.00	\$3,969.52
336320	TruckVault Inc.	T-TYSEQUO-08N-TF	Sequoia Utility OS Dwr	\$2,745.00	\$2,350.88
336320	TruckVault Inc.	T-TYSNAM1-04N	Toyota Sienna Mag 1 Dwr, dimensions: 47L x 48W	\$2,295.00	\$1,965.49
336320	TruckVault Inc.	T-TYSNAM1-11N	Toyota Sienna Mag 1 Dwr, dimensions: 43L x 48W	\$2,295.00	\$1,965.49
336320	TruckVault Inc.	T-TYSNAM1-11N-ZC9473	Sienna Mag 1 Dwr	\$2,135.00	\$1,828.46
336320	TruckVault Inc.	T-TYSNAM1-98N	Toyota Sienna Mag 1 Dwr, dimensions: 43.5L x 43W	\$2,295.00	\$1,965.49
336320	TruckVault Inc.	T-TYSNAM2-04N	Toyota Sienna Mag 2 Dwr, dimensions: 47L x 48W	\$2,845.00	\$2,436.52
336320	TruckVault Inc.	T-TYSNAM2-11N	Sienna Mag 2 Dwr	\$2,845.00	\$2,436.52
336320	TruckVault Inc.	T-TYSNAMO-04N	Toyota Sienna Mag Offset Dwr, dimensions: 47L x 48W	\$2,845.00	\$2,436.52
336320	TruckVault Inc.	T-TYSNAMO-11N	Toyota Sienna Mag Offset Dwr, dimensions: 43L x 48W	\$2,845.00	\$2,436.52
336320	TruckVault Inc.	T-TYSNAS1-04N	Toyota Sienna Std 1 Dwr, dimensions: 49L x 48W	\$2,215.00	\$1,896.98
336320	TruckVault Inc.	T-TYSNAS1-11N	Sienna Std 1 Dwr	\$2,215.00	\$1,896.98
336320	TruckVault Inc.	T-TYSNAS1-11N-C1-ZC9480	Sienna Custom	\$1,685.00	\$1,443.07
336320	TruckVault Inc.	T-TYSNAS2-04N	Toyota Sienna Std 2 Dwr, dimensions: 49L x 48W	\$2,755.00	\$2,359.45

336320	TruckVault Inc.	T-TYSNAS2-11N	Sienna Std 2 Dwr	\$2,765.00	\$2,368.01
336320	TruckVault Inc.	T-TYSNAS2-11N-TT	Sienna Std 2 DwrTop Tray	\$3,525.00	\$3,018.89
336320	TruckVault Inc.	T-TYSNASO-11N	Sienna Std OS Dwr	\$2,765.00	\$2,368.01
336320	TruckVault Inc.	T-TYSNAU1-11N	Sienna Utility 1 Dwr	\$2,195.00	\$1,879.85
336320	TruckVault Inc.	T-TYSNAU2-11N	Sienna Utility 2 Dwr	\$2,945.00	\$2,522.17
336320	TruckVault Inc.	T-TYTACM1-05S-HP	Tacoma Pickup Mag1 Dwr6' Short Bed; Passenger Side	\$2,395.00	\$2,051.13
336320	TruckVault Inc.	T-TYTACM1-05S-HP-PW	Tacoma Pickup Mag 1 Dwr	\$2,945.00	\$2,522.17
336320	TruckVault Inc.	T-TYTACM1-05S-PC-HD	Tacoma Pickup Mag 1 Dwr	\$2,195.00	\$1,879.85
336320	TruckVault Inc.	T-TYTACM1-05S-PC-HD-PW	Tacoma Pickup Mag 1 Dwr	\$2,445.00	\$2,093.95
336320	TruckVault Inc.	T-TYTACM1-05S-PC-HP	Tacoma Pickup Mag 1 Dwr5' Short Bed; Passenger Side	\$2,195.00	\$1,879.85
336320	TruckVault Inc.	T-TYTACM1-05S-PC-HP-PW	Tacoma Pickup Mag 1 Dwr	\$2,445.00	\$2,093.95
336320	TruckVault Inc.	T-TYTACM1-05S-PC-HP-PW-RX	Tacoma Pickup Mag 1 Dwr ReTrax5' SB, A-Wthr, Passenger Side	\$2,145.00	\$1,837.03
336320	TruckVault Inc.	T-TYTACM1-99S-HP	Tacoma Pickup Mag 1 Dwr6' Short Bed; Passenger Side	\$2,395.00	\$2,051.13
336320	TruckVault Inc.	T-TYTACM2-05S	Tacoma Pickup Mag 2 Dwr	\$3,345.00	\$2,864.74
336320	TruckVault Inc.	T-TYTACM2-05S-PC	Tacoma Pickup Mag 2 Dwr	\$3,145.00	\$2,693.45
336320	TruckVault Inc.	T-TYTACM2-05S-PC-HT	Tacoma Pickup Mag 2 Dwr5' Short Bed; HD Table Ext	\$3,840.00	\$3,288.66
336320	TruckVault Inc.	T-TYTACM2-05S-PC-PW	Toyota Tacoma Pickup Mag 2 Dwr, dimensions: 59L x 42.5W	\$3,945.00	\$3,378.59
336320	TruckVault Inc.	T-TYTACM2-05S-PT	Tacoma Pickup Mag 2 Dwr	\$3,840.00	\$3,288.66
336320	TruckVault Inc.	T-TYTACM2-05S-PW	Toyota Tacoma Pickup Mag 2 Dwr, dimensions: 72.5L x 42.5W	\$4,545.00	\$3,892.44
336320	TruckVault Inc.	T-TYTACM2-95S-PD	Tacoma Pickup Mag 2 Dwr	\$3,145.00	\$2,693.45
336320	TruckVault Inc.	T-TYTACM2-95S-PD-HT	Tacoma Pickup Mag 2 DwrDouble Cab HD Table	\$3,840.00	\$3,288.66
336320	TruckVault Inc.	T-TYTACM2-95S-PD-PW	Toyota Tacoma Pickup Mag 2 Dwr, dimensions: 60L x 40W	\$4,245.00	\$3,635.52
336320	TruckVault Inc.	T-TYTACM2-95S-PW	Tacoma Pickup Mag 2 Dwr	\$4,245.00	\$3,635.52
336320	TruckVault Inc.	T-TYTACMO-05S	Tacoma Pickup Mag Offset	\$3,345.00	\$2,864.74
336320	TruckVault Inc.	T-TYTACMO-05S-PC	Tacoma Pickup Mag Offset	\$3,145.00	\$2,693.45
336320	TruckVault Inc.	T-TYTACMO-05S-PC-PW	Toyota Tacoma Pickup Mag OS Dwr, dimensions: 59L x 42.5W	\$3,535.00	\$3,027.46
336320	TruckVault Inc.	T-TYTACMO-05S-PW	Toyota Tacoma Pickup Mag OS Dwr, dimensions: 72.5L x 42.5W	\$4,545.00	\$3,892.44
336320	TruckVault Inc.	T-TYTACMO-05S-PW-ZC11440	Tacoma Pickup Mag Offset Dwr	\$4,425.00	\$3,789.67
336320	TruckVault Inc.	T-TYTACMO-95S	Tacoma Pickup Mag OS Dwr	\$3,345.00	\$2,864.74
336320	TruckVault Inc.	T-TYTACMO-95S-PD	Tacoma Pickup Mag OS Dwr	\$3,145.00	\$2,693.45
336320	TruckVault Inc.	T-TYTACMO-95S-PD-PW	Toyota Tacoma Pickup Mag OS Dwr, dimensions: 59L x 40.75W	\$3,945.00	\$3,378.59
336320	TruckVault Inc.	T-TYTACMO-95S-PW	Tacoma Pickup Mag OS Dwr	\$4,245.00	\$3,635.52
336320	TruckVault Inc.	T-TYTACS1-05S-HD	Tacoma Std 1 Dwr Half Width	\$2,195.00	\$1,879.85
336320	TruckVault Inc.	T-TYTACS1-05S-HD-PW	Tacoma Pickup Std 1 Dwr	\$2,325.00	\$1,991.18
336320	TruckVault Inc.	T-TYTACS1-05S-HP	Tacoma Std 1 Dwr Half Width	\$2,025.00	\$1,734.26
336320	TruckVault Inc.	T-TYTACS1-05S-HP-PW	Tacoma Pickup Std 1 Dwr	\$2,745.00	\$2,350.88
336320	TruckVault Inc.	T-TYTACS1-05S-HP-ZC9169	Tacoma Std 1 Dwr Half Width	\$1,915.00	\$1,640.05
336320	TruckVault Inc.	T-TYTACS1-05S-PC-HD	Tacoma Pickup Std 1 Dwr	\$1,995.00	\$1,708.56
336320	TruckVault Inc.	T-TYTACS1-05S-PC-HD-PW	Tacoma Pickup Std 1 Dwr	\$2,245.00	\$1,922.67
336320	TruckVault Inc.	T-TYTACS1-05S-PC-HP	Tacoma Pickup Std 1 Dwr	\$1,995.00	\$1,708.56
336320	TruckVault Inc.	T-TYTACS1-05S-PC-HP-PW	Toyota Tacoma Pickup Std 1 Dwr, dimensions: 59L x 20W	\$2,245.00	\$1,922.67
336320	TruckVault Inc.	T-TYTACS1-95S-PD-HD-PW	Tacoma Pickup Std 1 Dwr	\$2,245.00	\$1,922.67
336320	TruckVault Inc.	T-TYTACS2-05S	Tacoma Pickup Std 2 Dwr	\$3,145.00	\$2,693.45
336320	TruckVault Inc.	T-TYTACS2-05S-PC-PW	Toyota Tacoma Pickup Std 2 Dwr, dimensions: 59L x 40W	\$3,315.00	\$2,839.04
336320	TruckVault Inc.	T-TYTACS2-05S-PW	Toyota Tacoma Pickup Std 2 Dwr, dimensions: 72.5L x 40.5W	\$4,345.00	\$3,721.16
336320	TruckVault Inc.	T-TYTACS2-05S-ZC10972C	Tacoma Pickup Custom 2 Dwr	\$2,955.00	\$2,530.73
336320	TruckVault Inc.	T-TYTACS2-95S-PD-PW	Toyota Tacoma Pickup Std 2 Dwr, dimensions: 60L x 40W	\$4,045.00	\$3,464.23
336320	TruckVault Inc.	T-TYTACS2-95S-PW	Tacoma Pickup Std 2 Dwr	\$4,345.00	\$3,721.16
336320	TruckVault Inc.	T-TYTACSO-05S	Tacoma Pickup Std OS Dwr	\$3,145.00	\$2,693.45
336320	TruckVault Inc.	T-TYTACSO-05S-PC-PW	Toyota Tacoma Pickup Std Offset, dimensions: 59L x 40W	\$3,745.00	\$3,207.30
336320	TruckVault Inc.	T-TYTACSO-05S-PW	Toyota Tacoma Pickup Std Offset, dimensions: 72.5L x 41.75W	\$4,345.00	\$3,721.16
336320	TruckVault Inc.	T-TYTACSO-95S	Tacoma Pickup Std Offset Dwr	\$3,145.00	\$2,693.45
336320	TruckVault Inc.	T-TYTACSO-95S-PD-PW	Toyota Tacoma Pickup Std OS Dwr, dimensions: 60L x 40W	\$4,045.00	\$3,464.23
336320	TruckVault Inc.	T-TYTACU1-05S-HD	Tacoma Pickup Utility 1 Dwr6' Short Bed; Drivers Side	\$2,295.00	\$1,965.49
336320	TruckVault Inc.	T-TYTACU1-05S-HP	Tacoma Pickup Utility 1 Dwr	\$2,295.00	\$1,965.49
336320	TruckVault Inc.	T-TYTACU1-05S-HP-PW	Tacoma Pickup Utility1 Dwr6' SB, A-Wthr, Passenger Side	\$2,845.00	\$2,436.52
336320	TruckVault Inc.	T-TYTACU1-05S-PC-HP	Tacoma Pickup Utility 1 Dwr	\$2,095.00	\$1,794.21
336320	TruckVault Inc.	T-TYTACU1-05S-PC-HP-PW	Tacoma Pickup Utility 1 Dwr	\$2,345.00	\$2,008.31
336320	TruckVault Inc.	T-TYTACU2-05S	Tacoma Pickup Utility 2 Dwr	\$3,245.00	\$2,779.09
336320	TruckVault Inc.	T-TYTACU2-05S-PC	Tacoma Pickup Utility 2 Dwr	\$3,045.00	\$2,607.81
336320	TruckVault Inc.	T-TYTACU2-05S-PC-PW	Tacoma Pickup Utility 2 Dwr	\$3,845.00	\$3,292.95
336320	TruckVault Inc.	T-TYTACU2-05S-PW	Tacoma Pickup Utility 2 Dwr	\$4,445.00	\$3,806.80
336320	TruckVault Inc.	T-TYTACU2-95S-PD	Tacoma Pickup Utility 2 Dwr	\$3,045.00	\$2,607.81
336320	TruckVault Inc.	T-TYTACUO-05S	Tacoma Pickup Utility OS Dwr	\$3,245.00	\$2,779.09

336320	TruckVault Inc.	T-TYTACUO-05S-PC	Tacoma Pickup Utility OS Dwr	\$3,045.00	\$2,607.81
336320	TruckVault Inc.	T-TYTACUO-05S-PC-PW	Tacoma Pickup Utility OS Dwr	\$3,845.00	\$3,292.95
336320	TruckVault Inc.	T-TYTACUO-05S-PW	Tacoma Pickup Utility Offset	\$4,445.00	\$3,806.80
336320	TruckVault Inc.	T-TYTUNM1-00S-HP	Tundra Mag 1 Dwr Half Width	\$2,545.00	\$2,179.60
336320	TruckVault Inc.	T-TYTUNM1-00S-HP-PW	Tundra Mag 1 Dwr Half Width	\$3,045.00	\$2,607.81
336320	TruckVault Inc.	T-TYTUNM1-04S-PD-HD	Tundra Pickup Mag 1 Dwr	\$2,545.00	\$2,179.60
336320	TruckVault Inc.	T-TYTUNM1-04S-PD-HP	Tundra Pickup Mag 1 Dwr	\$2,545.00	\$2,179.60
336320	TruckVault Inc.	T-TYTUNM1-04S-PD-HP-PW	Tundra Mag 1 Dwr Half Width	\$2,745.00	\$2,350.88
336320	TruckVault Inc.	T-TYTUNM1-07S-HP	Toyota Tundra Pickup Mag 1 Dwr, dimensions: 75L x 24W	\$2,545.00	\$2,179.60
336320	TruckVault Inc.	T-TYTUNM1-07S-HP-PW	Tundra Mag 1 Dwr Half Width6'6", All Wthr;Passenger Side	\$3,045.00	\$2,607.81
336320	TruckVault Inc.	T-TYTUNM1-07S-HP-RX-PW	Tundra Mag 1 Dwr Half Width ReTraxShortbed, All Wthr; Passenger Side	\$2,545.00	\$2,179.60
336320	TruckVault Inc.	T-TYTUNM1-07S-PX-HD	Tundra Pickup Mag 1 Dwr	\$2,395.00	\$2,051.13
336320	TruckVault Inc.	T-TYTUNM1-07S-PX-HD-PW	Toyota Tundra Mag 1 Dwr Half Width, dimensions: 64L x 24W	\$2,745.00	\$2,350.88
336320	TruckVault Inc.	T-TYTUNM1-07S-PX-HD-RX-PW	Tundra Mag 1 Dwr Half Width ReTraxCrewMax, All Wthr; Drivers Side	\$2,545.00	\$2,179.60
336320	TruckVault Inc.	T-TYTUNM1-07S-PX-HP-PW	Tundra Mag 1 Dwr Half Width	\$2,745.00	\$2,350.88
336320	TruckVault Inc.	T-TYTUNM1-07S-PX-HP-RX-PW	Tundra Mag 1 Dwr Half Width ReTraxCrewMax, All Wthr; Passenger Side	\$2,545.00	\$2,179.60
336320	TruckVault Inc.	T-TYTUNM2-00L	Toyota Tundra Pickup Mag 2 Dwr, dimensions: 1L x 1W	\$3,945.00	\$3,378.59
336320	TruckVault Inc.	T-TYTUNM2-00S	Toyota Tundra Pickup Mag 2 Dwr, dimensions: 73L x 48W	\$3,745.00	\$3,207.30
336320	TruckVault Inc.	T-TYTUNM2-00S-PT	Toyota Tundra Pickup Mag 2 Dwr, dimensions: 0L x 0W	\$4,260.00	\$3,648.36
336320	TruckVault Inc.	T-TYTUNM2-03S-PD	Toyota Tundra Pickup Mag 2 Dwr, dimensions: 72.75L x 48W	\$3,745.00	\$3,207.30
336320	TruckVault Inc.	T-TYTUNM2-03S-PD-PT	Toyota Tundra Pickup Mag 2 Dwr, dimensions: 72.75L x 48W	\$4,440.00	\$3,802.52
336320	TruckVault Inc.	T-TYTUNM2-04S-PD	Toyota Tundra Pickup Mag 2 Dwr, dimensions: 71.75L x 48W	\$3,545.00	\$3,036.02
336320	TruckVault Inc.	T-TYTUNM2-04S-PD-PW	Toyota Tundra Pickup Mag 2 Dwr, dimensions: 76L x 48W	\$4,645.00	\$3,978.09
336320	TruckVault Inc.	T-TYTUNM2-07L	Toyota Tundra Pickup Mag 2 Dwr, dimensions: 94L x 48W	\$3,945.00	\$3,378.59
336320	TruckVault Inc.	T-TYTUNM2-07L-PW	Toyota Tundra Pickup Mag 2 Dwr, dimensions: 94L x 48W	\$4,945.00	\$4,235.01
336320	TruckVault Inc.	T-TYTUNM2-07S	Toyota Tundra Pickup Mag 2 Dwr, dimensions: 75L x 48W	\$3,745.00	\$3,207.30
336320	TruckVault Inc.	T-TYTUNM2-07S-PD	Tundra Pickup Mag 2 Dwr	\$3,745.00	\$3,207.30
336320	TruckVault Inc.	T-TYTUNM2-07S-PW	Toyota Tundra Pickup Mag 2 Dwr, dimensions: 76L x 48W	\$4,645.00	\$3,978.09
336320	TruckVault Inc.	T-TYTUNM2-07S-PW-ZC11329A	Tundra Pickup Mag 2 Dwr	\$4,115.00	\$3,524.18
336320	TruckVault Inc.	T-TYTUNM2-07S-PW-ZC9131	Tundra Pickup Mag 2 Dwr	\$4,065.00	\$3,481.36
336320	TruckVault Inc.	T-TYTUNM2-07S-PX	Toyota Tundra Pickup Mag 2 Dwr, dimensions: 62.5L x 48W	\$3,545.00	\$3,036.02
336320	TruckVault Inc.	T-TYTUNM2-07S-PX-PW	Toyota Tundra Pickup Mag 2 Dwr, dimensions: 64L x 48W	\$4,345.00	\$3,721.16
336320	TruckVault Inc.	T-TYTUNM2-07S-PX-ZC10627	Tundra Pickup Mag 2 DwrCrewMax, SB shortened to 51"	\$3,275.00	\$2,804.79
336320	TruckVault Inc.	T-TYTUNM2-07S-ZC10528	Tundra Pickup Mag 2 DwrShort Bed shortened to 46"	\$3,275.00	\$2,804.79
336320	TruckVault Inc.	T-TYTUNMO-00S	Toyota Tundra Pickup Mag Offset Dwr, dimensions: 73L x 48W	\$3,745.00	\$3,207.30
336320	TruckVault Inc.	T-TYTUNMO-00S-PW	Tundra Pickup Mag OS Dwr	\$4,645.00	\$3,978.09
336320	TruckVault Inc.	T-TYTUNMO-03S-PD	Toyota Tundra Pickup Mag Offset Dwr, dimensions: 72.75L x 48W	\$3,745.00	\$3,207.30
336320	TruckVault Inc.	T-TYTUNMO-03S-PD-PT	Toyota Tundra Pickup Mag Offset Dwr, dimensions: 72.75L x 48W	\$4,440.00	\$3,802.52
336320	TruckVault Inc.	T-TYTUNMO-03S-PD-PW	Toyota Tundra Pickup Mag OS Dwr, dimensions: 72.75L x 48W	\$4,645.00	\$3,978.09
336320	TruckVault Inc.	T-TYTUNMO-03S-PD-PW-ZC10339	Tundra Custom Mag Offset DwrC10339	\$5,055.00	\$4,329.22
336320	TruckVault Inc.	T-TYTUNMO-03S-PD-PW-ZC10973B	Tundra Custom Mag Offset DwrC10973B	\$5,055.00	\$4,329.22
336320	TruckVault Inc.	T-TYTUNMO-04S-PD-PW	Toyota Tundra Pickup Mag OS Dwr, dimensions: 0L x 0W	\$4,645.00	\$3,978.09
336320	TruckVault Inc.	T-TYTUNMO-07L	Toyota Tundra Pickup Mag OS Dwr, dimensions: 94L x 48W	\$3,945.00	\$3,378.59
336320	TruckVault Inc.	T-TYTUNMO-07L-PW	Toyota Tundra Pickup Mag OS Dwr, dimensions: 94L x 48W	\$4,945.00	\$4,235.01
336320	TruckVault Inc.	T-TYTUNMO-07S	Toyota Tundra Pickup Mag Offset Dwr, dimensions: 75L x 48W	\$3,745.00	\$3,207.30
336320	TruckVault Inc.	T-TYTUNMO-07S-PT	Toyota Tundra Pickup Mag OS Dwr, dimensions: 75L x 48W	\$4,440.00	\$3,802.52
336320	TruckVault Inc.	T-TYTUNMO-07S-PW	Toyota Tundra Pickup Mag OS Dwr, dimensions: 76L x 48W	\$4,645.00	\$3,978.09
336320	TruckVault Inc.	T-TYTUNMO-07S-PX	Toyota Tundra Pickup Mag OS Dwr, dimensions: 62.5L x 48W	\$3,545.00	\$3,036.02
336320	TruckVault Inc.	T-TYTUNMO-07S-PX-HT	Toyota Tundra Pickup Mag OS Dwr, dimensions: 59.5L x 48W	\$4,040.00	\$3,459.95
336320	TruckVault Inc.	T-TYTUNMO-07S-PX-PT	Toyota Tundra Pickup Mag OS Dwr, dimensions: 62.5L x 48W	\$4,240.00	\$3,631.23
336320	TruckVault Inc.	T-TYTUNMO-07S-PX-PW	Toyota Tundra Pickup Mag OS Dwr, dimensions: 64L x 48W	\$4,345.00	\$3,721.16
336320	TruckVault Inc.	T-TYTUNMO-07S-PX-PW-ZC10818	Tundra Pickup Mag OS DwrC10818	\$4,425.00	\$3,789.67
336320	TruckVault Inc.	T-TYTUNMO-07S-PX-RX-PW	Tundra Pickup Mag OS Dwr SB,Shortened for Remax, A-Wthr	\$4,045.00	\$3,464.23
336320	TruckVault Inc.	T-TYTUNMO-07S-PX-ZC10627	Tundra Pickup Mag Offset DwrCrewMax, SB shortened to 51"	\$3,275.00	\$2,804.79
336320	TruckVault Inc.	T-TYTUNN2-00S-PW-ZC11090	Tundra Pickup CustomC11090	\$4,955.00	\$4,243.58
336320	TruckVault Inc.	T-TYTUNN2-07L-ZC8341	Tundra Pickup CUST 2 Dwr	\$3,835.00	\$3,284.38
336320	TruckVault Inc.	T-TYTUNN2-07L-ZC8431	Tundra Pickup CUST 2 Dwr	\$3,835.00	\$3,284.38
336320	TruckVault Inc.	T-TYTUNNO-07S-PW-ZC11005	Tundra Pickup CustomC11005	\$4,585.00	\$3,926.70
336320	TruckVault Inc.	T-TYTUNNO-07S-PX-PW-ZC11005	Tundra Pickup CustomC11005	\$4,585.00	\$3,926.70
336320	TruckVault Inc.	T-TYTUNSI-07S-HD-PW	Tundra Std 1 Dwr Half Width	\$2,845.00	\$2,436.52
336320	TruckVault Inc.	T-TYTUNSI-07S-HP	Toyota Tundra Pickup Std 1 Dwr, dimensions: 75L x 24W	\$2,325.00	\$1,991.18
336320	TruckVault Inc.	T-TYTUNSI-07S-HP-PW	Tundra Std 1 Dwr Half Width	\$2,845.00	\$2,436.52



336320	TruckVault Inc.	T-VLXC6M1-09N-HT	XC 60 Mag 1 Dwr	\$2,790.00	\$2,389.42
336320	TruckVault Inc.	T-VLXC6M2-09N	Volvo XC 60 Mag 2 Dwr, dimensions: 30L x 40W	\$2,645.00	\$2,265.24
336320	TruckVault Inc.	T-VLXC6S1-09N	Volvo XC 60 Std 1 Dwr, dimensions: 32L x 40W	\$1,895.00	\$1,622.92
336320	TruckVault Inc.	T-VLXC6S2-09N	Volvo XC 60 Std 2 Dwr, dimensions: 32L x 40W	\$2,445.00	\$2,093.95
336320	TruckVault Inc.	T-VLXC7M1-08N	Volvo XC 70 Mag 1 Dwr, dimensions: 34L x 41W	\$2,095.00	\$1,794.21
336320	TruckVault Inc.	T-VLXC7M2-00N	XC 70 Mag 2 DwrWagon	\$2,645.00	\$2,265.24
336320	TruckVault Inc.	T-VLXC7M2-08N	Volvo XC 70 Mag 2 Dwr, dimensions: 34L x 41W	\$2,645.00	\$2,265.24
336320	TruckVault Inc.	T-VLXC7MO-00N	XC 70 Mag 2 Dwr OffsetWagon	\$2,645.00	\$2,265.24
336320	TruckVault Inc.	T-VLXC7MO-00N-HT	XC 70 Mag 2 Dwr OffsetWagon	\$3,340.00	\$2,860.45
336320	TruckVault Inc.	T-VLXC7S1-08N	Volvo XC 70 Std 1 Dwr, dimensions: 36L x 41W	\$2,095.00	\$1,794.21
336320	TruckVault Inc.	T-VLXC7S2-08N	Volvo XC 70 Std 2 Dwr, dimensions: 36L x 41W	\$2,215.00	\$1,896.98
336320	TruckVault Inc.	T-VLXC7SO-00N	XC 70 Std OS Dwr	\$2,445.00	\$2,093.95
336320	TruckVault Inc.	T-VLXC9M1-03N	Volvo XC 90 Mag 1 Dwr, dimensions: 39L x 42W	\$2,295.00	\$1,965.49
336320	TruckVault Inc.	T-VLXC9M1-14S	XC 90 Mag 1 Dwr	\$1,895.00	\$1,622.92
336320	TruckVault Inc.	T-VLXC9M2-03N	Volvo XC 90 Mag 2 Dwr, dimensions: 39L x 42W	\$2,845.00	\$2,436.52
336320	TruckVault Inc.	T-VLXC9S1-03N	Volvo XC 90 Std 1 Dwr, dimensions: 41L x 42W	\$2,095.00	\$1,794.21
336320	TruckVault Inc.	T-VLXC9S1-14S	XC 90 Std 1 Dwr	\$1,695.00	\$1,451.64
336320	TruckVault Inc.	T-VLXC9S2-03N	Volvo XC 90 Std 2 Dwr, dimensions: 41L x 42W	\$2,645.00	\$2,265.24
336320	TruckVault Inc.	T-VLXC9S2-14N	XC 90 Std 2 Dwr	\$2,645.00	\$2,265.24
336320	TruckVault Inc.	T-VLXC9U1-14S	XC 90 Utility 1 Dwr	\$1,795.00	\$1,537.28
336320	TruckVault Inc.	T-VWAMAS2-15S-PC-PW	Amarok Pickup Std 2 Dwr	\$3,745.00	\$3,207.30
336320	TruckVault Inc.	T-VVATLM1-18N	Atlas Mag 1 Dwr	\$2,295.00	\$1,965.49
336320	TruckVault Inc.	T-VVATLS1-18N	Atlas Std 1 Dwr	\$2,095.00	\$1,794.21
336320	TruckVault Inc.	T-VVATLS2-18N	Atlas Std 2 Dwr	\$2,645.00	\$2,265.24
336320	TruckVault Inc.	T-VVATLSO-18N	Atlas Std 2 Dwr Offset	\$2,645.00	\$2,265.24
336320	TruckVault Inc.	T-VVATLU1-18N	Atlas Utility 1 Dwr	\$2,195.00	\$1,879.85
336320	TruckVault Inc.	T-VVATLU1-20N	Atlas Cross Sport Utility 1 DwrNo 3rd Seat	\$1,995.00	\$1,708.56
336320	TruckVault Inc.	T-VWGATM1-15N	Golf All Track Mag 1 Dwr	\$2,095.00	\$1,794.21
336320	TruckVault Inc.	T-VWGATM2-15N	Golf All Track Mag 2 Dwr	\$2,645.00	\$2,265.24
336320	TruckVault Inc.	T-VWGATS2-15N	Golf All Track Standard 2 Dwr	\$2,445.00	\$2,093.95
336320	TruckVault Inc.	T-VWGOLM2-15N	Golf Mag 2 Dwr	\$2,445.00	\$2,093.95
336320	TruckVault Inc.	T-VWJSWS1-05N	Volkswagen Jetta Sport Wagen Std 1 Dwr, dimensions: 32L x 38W	\$1,895.00	\$1,622.92
336320	TruckVault Inc.	T-VWJSWS2-05N	Volkswagen Jetta Sport Wagen Std 2 Dwr, dimensions: 32L x 38W	\$2,445.00	\$2,093.95
336320	TruckVault Inc.	T-VWTGNM1-07N	Tiguan Mag 1 Dwr	\$1,895.00	\$1,622.92
336320	TruckVault Inc.	T-VWTGNS1-07N	Touareg Std 1 Dwr	\$1,895.00	\$1,622.92
336320	TruckVault Inc.	T-VWTGNSO-07N	Volkswagen Tiguan Std Offset, dimensions: 32L x 42W	\$2,445.00	\$2,093.95
336320	TruckVault Inc.	T-VWTRGM1-04N	Volkswagen Touareg Mag 1 Dwr, dimensions: 30L x 42W	\$2,095.00	\$1,794.21
336320	TruckVault Inc.	T-VWTRGS1-04N	Volkswagen Touareg Std 1 Dwr, dimensions: 32L x 42W	\$1,895.00	\$1,622.92
336320	TruckVault Inc.	T-VWTRGS1-10N	Touareg Std 1 Dwr	\$1,895.00	\$1,622.92
336320	TruckVault Inc.	T-VWTRGS2-04N	Volkswagen Touareg Std 2 Dwr, dimensions: 32L x 42W	\$2,445.00	\$2,093.95
336320	TruckVault Inc.	T-VWTRGSO-04N	Volkswagen Touareg Std Offset Dwr, dimensions: 32L x 42W	\$2,445.00	\$2,093.95



# AGENDA MEMORANDUM

**Meeting Date:** 06/28/2021

**To:** The Honorable Mayor and Members of the City Council

**From:** William Alonso, City Manager

**Subject:** “Together We Can” Medley monument

---

At the April 26, 2021 Council meeting, Barbara Sanchez, President and Founder of the Crime Prevention Alliance of Florida, made a presentation on the monument being place in Medley to honor Senior Citizens. Ms. Sanchez asked Council at that meeting if the city would come up with a list of names the city would like to include in this memorial. Staff has been working on this list of Seniors we felt would be worthy of such an honor and here are the names we have come up with:

Paul Mayhew  
Wade Smith  
Jean Ansbaugh  
Lisbeth Toro  
Cristina Robaina  
Joan Hutchings  
Joe Deery  
Margaret Watson  
Betty Dunn  
Joan Cavalier  
Irene Priess  
Jim Caudle  
Betty Bray  
Karen Rosson

Staff requests that Council discuss if there are any other names they want to see included in this monument.

The cost per brick is \$62 so if we do all of the name listed above the total cost is \$868.





6080 SW 40<sup>th</sup> Street, Suite 10  
Miami, FL 33155

786-343-0962  
crimepreventionalliance@hotmail.com  
www.crimepreventionalliance.com

Dear Honorable, Mayor Maria Mitchell and City of Miami Springs;

We request to make a brief presentation for the participation for the First Monument dedicated to Senior Citizens titled "Together We Can"/"Juntos Podemos".

We would like for the Honorable, Mayor Maria Mitchell and City of Miami Springs to choose (2-8) Senior Citizens in their respective city to place their names on the monument that will be permanent in the Town of Medley, Fl. This creation and alliance is for placing our Seniors Citizens First and for awareness of Senior Crimes. Chosen Honorees can be Seniors over the age of 62 that through their hard work, community involvement, volunteer positions, or staff members will be honored. All Honorable, Mayors' name will also be permanently affixed on with their Honorees. "Please view Application". Minimal cost applies.

This monument will stand approximately 6" feet tall with four figures. Each Figure is of Fiberglass with bronze finish and surrounding colored cement base. A solidarity tile for covid 19 victims will also be displayed in a mellow, delicate 4x8 tile.

It has taken years to reach this stage and hard work to create this Monument and Significance. We want you to be part of this every step of the way. We look forward to formally showing you the Scale Model of the Monument. Thank you for all you do to keep Miami Springs safe and for caring for your community.

Kindly,

Barbara E. Sanchez, President and Founder  
Debbie Betancourt, Secretary Marcos Correa, V. President  
Lynne Brooks, VIP Adv. Committee Joe Bradwell, Honorary, V President  
Julio Cesar Hernandez, Sculptor/Artist Rene Alvarez, Executive Nancy Alvarez, Treasurer  
Carl Hastings, V. President Richard Smith, Executive Faustino Rodriguez, Treasurer  
Carlos M Rippes, Esq.





37 ARTICLE XVII. – NUISANCE ABATEMENT BOARD

38 Sec. 32-101. – Definitions.

39 For purposes of this article, the following words and phrases shall have the  
40 meanings respectively ascribed to them by this section, except where the context  
41 clearly indicates a different meaning:

42 Board means the City of Miami Springs' Public Nuisance Abatement Board.

43 Complaint means the official process by which cases are initiated and brought before  
44 the Board.

45 Public Nuisance means any place or premises that has been used:

46 (1) On more than two occasions within a six-month period, as the site of a  
47 violation of Section 796.07, Florida Statutes, as amended, entitled "Prohibiting  
48 prostitution and related acts";

49 (2) On more than two occasions within a six-month period, as the site of the  
50 unlawful sale, delivery, manufacture, or cultivation of any controlled substance;

51 (3) On one occasion as the site of the unlawful possession of a controlled  
52 substance, where such possession constitutes a felony and that has been previously  
53 used on more than one occasion as the site of the unlawful sale, delivery, manufacture,  
54 or cultivation of any controlled substance;

55 (4) By a criminal gang for the purpose of conducting a pattern of criminal  
56 gang-related activity as defined by Section 874.03, Florida Statutes, as amended;

57 (5) On more than two occasions within a six-month period, as the site of a  
58 violation of Section 812.019, Florida Statutes, as amended, relating to dealing in stolen  
59 property;

60 (6) On two or more occasions within a six-month period, as the site of a  
61 violation of chapter 499, Florida Statutes, as amended, entitled the "Florida Drug and  
62 Cosmetic Act";

63 (7) On more than two occasions within a six-month period, as the site of a  
64 violation of any combination of the following:

65 (a) Section 782.04, Florida Statutes, relating to murder;

66 (b) Section 782.051, Florida Statutes, relating to attempted felony  
67 murder;

68 (c) Section 784.045(1)(a)2., Florida Statutes, relating to aggravated  
69 battery with a deadly weapon; or

70 (d) Section 784.021(1)(a), Florida Statutes, relating to aggravated  
71 assault with a deadly weapon without intent to kill.

72 Operator means an owner or person that has control or possession of a building, place,  
73 or premise, or an agent in charge of or otherwise having interest in or control of a  
74 building, place or premise.

75 Sec. 32-102. – Public Nuisance Abatement Board.

76 The City of Miami Springs Public Nuisance Abatement Board is hereby created and  
77 established to preside over cases involving Public Nuisances. The Board shall have the  
78 power to abate Public Nuisances pursuant to the procedures provided in this article.  
79 The Board shall consist of

- 80 (A) Creation; membership; terms; compensation.  
81 (1) The Code Compliance Board for the City of Miami Springs is hereby  
82 designated as the Public Nuisance Abatement Board.  
83 (2) The terms of office of Board members shall coincide with the terms of  
84 office of the corresponding Code Compliance Board member.  
85 (3) Board members shall serve without compensation but may be reimbursed  
86 for such travel, mileage, and per diem expenses as may be authorized by  
87 the City Manager.  
88 (B) Organization of the Board; administrative staff.  
89 (1) The members of the Board shall elect a chairperson and vice-chairperson,  
90 who shall serve in the absence of the chairperson.  
91 (2) The City shall provide clerical and administrative personnel as may be  
92 reasonably required by the Board for the proper performance of its duties.  
93 (3) The City Attorney's office shall represent the City and present cases  
94 before the Board.

95 Sec. 32-103. – Notice.

- 96 (A) All notices required by this article must be provided by:  
97 (1) Certified mail to the Operator's address listed in the Miami-Dade County Tax  
98 Collector's office for tax notices or to the mailing address listed in the Miami-  
99 Dade County Property Appraiser's database; or  
100 (2) Hand delivery by the sheriff, other law enforcement officer, or process server  
101 to the Operator at the Operator's last known address.  
102 (B) If an attempt to serve notice upon the Operator by hand delivery or certified mail  
103 is unsuccessful, service of the notice may be made by posting notice at the  
104 building, place, or premises where the Public Nuisance is alleged to exist. Such  
105 notice may be posted at least 10 calendar days prior to the hearing on a Public  
106 Nuisance complaint.  
107 (C) Where the Operator is not the owner of the building, place, or premises that is  
108 the subject of a Public Nuisance complaint, notice shall also be provided to the  
109 owner in accordance with this section.  
110 (D) Evidence that an attempt has been made to furnish notice as provided in  
111 subsection (A), together with proof of posting as provided in subsection (B), if  
112 applicable, shall be sufficient to show that the notice requirements of this section  
113 have been met, without regard to whether or not the Operator or owner actually  
114 received such notice.

115 Sec. 32-104. – Public Nuisance Complaints.

116 (A) Written complaints; reports.

117 (1) Any City employee, City officer, or any City resident may file a written  
118 complaint regarding a Public Nuisance with the City Police Department on  
119 a form prescribed by the City. The complaint shall state facts that  
120 reasonably tend to establish the existence of a Public Nuisance.

121 (2) Any police officer that makes an arrest or substantiates an incident or  
122 occurrence of a Public Nuisance shall provide a copy of every such report  
123 to the Chief of Police or designee. The Police Department shall process  
124 all such reports and determine whether the requisite number of  
125 occurrences or violations have taken place to constitute a Public  
126 Nuisance.

127 (3) Upon determining that a Public Nuisance exists, the Police Department  
128 shall mail written notice of such Public Nuisance to the Operator. The  
129 notice shall provide for the Operator to take good faith measures as are  
130 appropriate to abate the Public Nuisance within five days of receipt of the  
131 notice. The Police Department may extend the five days, when requested  
132 in writing by the Operator, to allow the Operator to institute or continue  
133 actions to abate the Public Nuisance, provided the actions are reasonable.  
134 In the event the Operator fails to take reasonable action to abate the  
135 Public Nuisance, the Police Department shall request that the clerk for the  
136 Board schedule a hearing on the Public Nuisance at the next available  
137 hearing date.

138 (B) Processing; review of case.

139 (1) In each case where a determination has been made in accordance with  
140 subsection (a) above, the case shall be processed through the Police  
141 Department and the Chief of Police or designee, in consultation with the  
142 City Attorney, shall determine whether such case is legally sufficient for  
143 presentation to the Board for consideration and disposition as provided  
144 herein.

145 (2) The City Manager, or designee, upon receipt of verification by the Police  
146 Department that all administrative prerequisites have been satisfied shall  
147 direct the clerk for the Board to prepare a case file for the complaint  
148 related to the maintenance of the Public Nuisance.

149 Sec. 32-105. – Notice of hearings; hearing procedures.

150 (A) Notice of hearings.

151 (1) The clerk for the Board shall schedule all hearings and issue notices for  
152 such hearings in accordance with section 32-103 of this article.

153 (2) Written notice of said hearing shall be provided by the clerk to the  
154 Operator and the complainant(s) at least ten calendar days prior to the  
155 scheduled hearing.

156 (3) The Operator shall be responsible for providing the notice of a hearing to  
157 any tenant, lessee, or lessor.

158 (4) The notice of hearing shall include a:

- 159 (a) Statement of the time, place, and nature of the hearing;  
160 (b) Statement of the legal authority and jurisdiction under which the  
161 hearing is to be held;  
162 (c) Reference to the particular statutes or ordinances involved; and  
163 (d) A copy of the subject complaint(s) of the Public Nuisance(s).  
164 (B) Conduct of Hearings.  
165 (1) All hearings of the Board shall be open to the public. The proceedings at  
166 the hearing shall be recorded and may be transcribed at the expense of  
167 the party requesting the transcript.  
168 (2) If proper notice was provided, the hearing may proceed in the absence of  
169 the Operator.  
170 (3) All testimony shall be under oath.  
171 (4) Each case before the Board shall be presented by the City Attorney or  
172 designee. The City shall have the burden of proving the existence of a  
173 Public Nuisance by clear and convincing evidence.  
174 (5) The hearing shall not be conducted in accordance with the formal rules  
175 relating to evidence and witnesses, but fundamental due process shall be  
176 observed and shall govern the proceedings.  
177 (6) The Board may consider any relevant evidence, including evidence of the  
178 general reputation of the place or premises.  
179 (7) Each party shall have the right to call and examine witnesses, to present  
180 evidence and argument on all relevant issues involved in the case, to  
181 conduct cross-examination and submit rebuttal evidence, and to be  
182 represented by counsel.  
183 (8) At the discretion of the Board, the general public may be given an  
184 opportunity to present oral testimony or other evidence. If the Board  
185 considers such evidence, then all parties shall be given an opportunity to  
186 cross-examine, challenge, or rebut it.  
187 (9) Orders of the Board shall be based upon competent and substantial  
188 evidence.  
189 (10) After considering all the evidence presented at the hearing, the  
190 Board may declare the building, place, or premises to be a Public  
191 Nuisance.  
192 (11) Upon finding that a Public Nuisance exists, the Board shall  
193 immediately order one or more of the following:  
194 (a) Discontinuance of the Public Nuisance;  
195 (b) Closing of the building, place, or premises;  
196 (c) Prohibition of the conduct, operation, or maintenance of any business  
197 or activity on the building, place, or premises which is conducive to the  
198 maintenance of the Public Nuisance, which prohibition may include the  
199 suspension of any City business tax receipt issued or renewed  
200 pursuant to Title XI, Chapter 113, entitled "Business Taxes," of the City  
201 Code;  
202 (d) Fines not to exceed \$250.00 for each day that the Board finds that the  
203 Public Nuisance existed and fines not to exceed \$500.00 per day for  
204 recurring Public Nuisances;

- 205                   (e) Any combination of this subsection.  
206           (12)       The total fines imposed pursuant to this section shall not exceed  
207                   \$15,000.  
208           (13)       The Board's order may be recorded in the public records of Miami-  
209                   Dade County, and upon recording shall constitute constructive notice of  
210                   the Public Nuisance to all subsequent purchasers, successors in interest,  
211                   or assigns of the real property that is the subject of the order.  
212           (14)       Orders of the Board shall be posted at the building, place, or  
213                   premises where the Public Nuisance exists, existed or is occurring, and  
214                   shall be sent by certified mail to the Operator and owner of record of such  
215                   building, place, or premises within two business days of the posting.  
216           (15)       An order entered pursuant to this Article shall expire after one year  
217                   or at such earlier time as stated in the order. The Board may retain  
218                   jurisdiction to modify the orders prior to the expiration of the orders where  
219                   just cause is found to exist.

220   Sec. 32-106. – Enforcement of Orders.

- 221           (A) Five business days after the posting of an order issued by the Board, the City  
222                   Police or Code Compliance Division shall be authorized to act upon and  
223                   enforce such order in accordance with this Article.  
224           (B) The City may institute proceedings in a court of competent jurisdiction for  
225                   willful disobedience or failure to comply with any order of the Board.  
226           (C) The City Attorney is authorized to initiate proceedings in any county, state, or  
227                   federal forum for the suspension or revocation of any permits, licenses,  
228                   concessions or contracts held or awarded to the Operator including, but not  
229                   limited to, contracts awarded under section 24.112, Florida Statutes, as  
230                   amended, and including licenses for the sale of beverages issued under  
231                   section 561.19, Florida Statutes, as amended, where the existence of such  
232                   permits, licenses, concessions or contracts is conducive to the maintenance  
233                   of the Public Nuisance.  
234           (D) Nothing contained within this Article prohibits the City from proceeding  
235                   against a Public Nuisance by any other means.

236   Sec. 32-107. – Costs.

237           In the event that the Board declares a place or premises to be a Public Nuisance  
238                   and issues an order pursuant to this Article, the Board shall assess against the owner of  
239                   the building, place, or premises where the Public Nuisance is found to exist the costs,  
240                   including but not limited to reasonable attorneys fees, which the City incurred in the  
241                   investigation, preparation, hearing and presentation of the case. These costs shall be  
242                   due and payable ten calendar days after the written order of the Board has been filed  
243                   with the City's Clerk. A certified copy of an order imposing costs may be recorded in the  
244                   public records and, thereafter, shall constitute a lien against the real property that is the  
245                   subject of the Board's order and provide for the foreclosure of the property subject to  
246                   the lien and the recovery of all costs, including but not limited to reasonable attorney  
247                   fees, associated with the recording of orders and foreclosure. Interest shall accrue on

248 the unpaid costs at the legal rate of interest set forth in section 55.03, Florida Statutes,  
249 as amended.



250 Sec. 32-108. – Appeals.

- 251 (A) An aggrieved party, including the City, may appeal a final order of the Board  
252 to the appellate division of the Circuit Court of the Eleventh Judicial Circuit of  
253 Florida. Such appeal must be filed within 30 days of rendition of the written  
254 order appealed from. An appeal shall not be a hearing de novo, but shall be  
255 limited to appellate review of the record created before the Board.  
256 (B) Unless the findings of the Board are overturned in an appeal pursuant to this  
257 section, all findings of the Board shall be admissible in any proceeding to  
258 collect unpaid costs and penalties.

259 Sec. 32-109. – Rights reserved.

260 This article does not restrict the right of any person, including but not limited to the City,  
261 to proceed under section 60.05, Florida Statutes, as amended, to abate a nuisance.

262 **Section 3. Conflicts.** All Sections or parts of Sections of the Code of  
263 Ordinances, all ordinances or parts of ordinances, and all Resolutions, or parts of  
264 Resolutions, in conflict with this Ordinance are repealed to the extent of such conflict.

265 **Section 4. Severability.** That the provisions of this Ordinance are declared to  
266 be severable and if any section, sentence, clause or phrase of this Ordinance shall for  
267 any reason be held to be invalid or unconstitutional, such decision shall not affect the  
268 validity of the remaining sections, sentences, clauses, and phrases of this Ordinance  
269 but they shall remain in effect, it being the legislative intent that this Ordinance shall  
270 stand notwithstanding the invalidity of any part.

271 **Section 5. Codification.** That it is the intention of the City Council and it is  
272 hereby ordained that the provisions of this Ordinance shall become and be made a part  
273 of the City Code, that the sections of this Ordinance may be renumbered or relettered to  
274 accomplish such intentions, and that the word Ordinance shall be changed to Section or  
275 other appropriate word.

276 **Section 6. Effective Date.** That this Ordinance shall become effective  
277 immediately upon adoption on second reading.

278 [THIS SPACE INTENTIONALLY LEFT BLANK.]

279 **PASSED ON FIRST READING** on the \_\_\_\_\_ day of \_\_\_\_\_, 2021, on a  
280 motion made by \_\_\_\_\_ and seconded by \_\_\_\_\_.

281 **PASSED AND ADOPTED ON SECOND READING** this \_\_\_ day of \_\_\_\_\_, 2021,  
282 on a motion made by \_\_\_\_\_ and seconded by \_\_\_\_\_. Upon being put to  
283 a roll call vote, the vote was as follows:

284 Vice Mayor Bob Best \_\_\_\_\_  
285 Councilwoman Jacky Bravo \_\_\_\_\_  
286 Councilman Dr. Walter Fajet \_\_\_\_\_  
287 Councilman Dr. Victor Vazquez \_\_\_\_\_  
288 Mayor Maria Puente Mitchell \_\_\_\_\_

289

290

291

292

293

\_\_\_\_\_  
MARIA PUENTE MITCHELL  
MAYOR

294

295 ATTEST:

296

297

298

299 \_\_\_\_\_  
300 ERIKA GONZALEZ, MMC  
301 CITY CLERK

302

303

304

305

306

307

308

309

\_\_\_\_\_  
WEISS SEROTA HELFMAN COLE & BIERMAN, P.L.  
CITY ATTORNEY



# AGENDA MEMORANDUM

**Meeting Date:** 6/28/2021

**To:** The Honorable Mayor Maria Puente Mitchell and Members of the City Council

**Via:** William Alonso, City Manager/Fin. Director

**From:** Omar L. Luna, Recreation Director

**Subject:** Recreation Department Fee Schedule

**RECOMMENDATION:**

Recommendation by the Recreation Department that Council Adopt the attached Resolution amending the Recreation Fee Schedule as shown in Exhibit “A” to include fees for rentals of our Miami Springs Adult Community Center.

**DISCUSSION:**

The new Miami Springs Adult Community Center opened its doors to Seniors in our community on February 28, 2021 and since this time, residents have inquired about the rental of spaces within the facility. The opportunities for rental at the new Center include the Rebeca Sosa Dining Hall, with or without the catering kitchen, the outside patio area which faces the Tot Lot playground and the multi-purpose classrooms which could be utilized for learning /training/ meeting spaces or for Art related activities, depending on the type of classroom they wish to rent. These added spaces allow residents several viable options in addition to the ones currently offered at the Recreation and Aquatic Center, while allowing for the City to generate some additional revenues from their rentals. The fees, if adopted, will become effective July 1<sup>st</sup>, 2021.

**Submission Date and Time:** 6/23/2021 11:12 AM

<u>Submitted by:</u>	<u>Approved by (sign as applicable):</u>	<u>Funding:</u>
Department: Recreation _____	Dept. Head: <u></u>	Dept./ Desc.: _____
Prepared by: Omar Luna _____	Procurement: _____	Account No.: _____
Attachments: <input checked="" type="checkbox"/> Yes <input type="checkbox"/> No	Asst. City Mgr.: _____	Additional Funding: _____
Budgeted/ Funded: <input type="checkbox"/> Yes <input checked="" type="checkbox"/> No	City Manager: _____	Amount previously approved: \$ _____
		Current request: \$ _____
		Total vendor amount: \$ _____

**RESOLUTION NO. 21-\_\_\_\_\_**

**A RESOLUTION OF THE MAYOR AND CITY COUNCIL OF THE CITY OF MIAMI SPRINGS, FLORIDA, AMENDING THE RECREATION DEPARTMENT SCHEDULE OF CHARGES; PROVIDING FOR AUTHORIZATION; AND PROVIDING FOR AN EFFECTIVE DATE.**

**WHEREAS**, pursuant to section 95-03 of the City of Miami Springs (the “City”) Code of Ordinances (“Code”), the City maintains a “Recreation Department Schedule of Charges” (the “Fee Schedule”) for use of the City’s recreation facilities and related services, which Fee Schedule may be amended by resolution of the City Council; and

**WHEREAS**, on August 28, 2018, the City Council adopted Resolution No. 2017-3743 approving the City’s current Fee Schedule; and

**WHEREAS**, on February 28, 2021, the City opened the Senior Center, located at 101 Apache Street, Miami Springs, Florida 33166; and

**WHEREAS**, the City Manager has recommended that the Council amend the Fee Schedule as shown on Exhibit “A” attached hereto to include fees for rentals of the Senior Center as well as other minor updates to the Fee Schedule; and

**WHEREAS**, the City Council desires to approve the amended Fee Schedule attached hereto as Exhibit “A” and finds that the amended Fee Schedule is fair, appropriate, and in the best interest of the City and its citizens.

**NOW, THEREFORE, BE IT RESOLVED BY THE MAYOR AND CITY COUNCIL OF THE CITY OF MIAMI SPRINGS, FLORIDA, AS FOLLOWS:**

**Section 1. Recitals.** The above recitals are true and correct and are incorporated herein by this reference.

**Section 2. Amending Fee Schedule.** The Fee Schedule attached hereto as Exhibit “A” is hereby amended and adopted.

**Section 3. Authorization.** The City Manager and City Attorney are hereby authorized to take such further action as may be necessary to implement the purpose and provisions of this Resolution. The City Manager is authorized to add and/or adjust the Fee Schedule based upon promotion and marketing activities to encourage use of the City’s recreational facilities and shall advise the City Council of such additions and/or adjustments via email within thirty days of the action.

**Section 4. Effective Date.** This Resolution shall take effect immediately upon adoption.

The foregoing Resolution was offered by \_\_\_\_\_ who moved its adoption. The motion was seconded by \_\_\_\_\_ and upon being put to a vote, the vote was as follows:

Vice Mayor Bob Best	_____
Councilwoman Jacky Bravo	_____
Councilwoman Dr. Walter Fajet	_____
Councilman Dr. Victor Vazquez	_____
Mayor Maria Puente Mitchell	_____

PASSED AND ADOPTED this 28<sup>th</sup> day of June, 2021.

\_\_\_\_\_  
MARIA PUENTE MITCHELL  
MAYOR

ATTEST:

\_\_\_\_\_  
ERIKA GONZALEZ, MMC  
CITY CLERK

APPROVED AS TO FORM AND LEGAL SUFFICIENCY  
FOR THE USE AND RELIANCE OF THE CITY OF MIAMI SPRINGS ONLY:

\_\_\_\_\_  
WEISS SEROTA HELFMAN COLE & BIERMAN, P.L.  
CITY ATTORNEY

**EXHIBIT A**

Fee Schedule

(Updated June 28, 2021; Effective July 1, 2021)

Note: The revisions on the attached Fee Schedule are shown in track changes.

**CITY OF MIAMI SPRINGS RECREATION DEPARTMENT**  
**SCHEDULE OF CHARGES**  
**EFFECTIVE ~~AUGUST 28, 2017~~ JULY 1, 2021**  
**(includes applicable taxes)**

<b>1. FITNESS ROOM MEMBERSHIP<sup>1</sup></b>	<b>Rates</b>	
	<b>Resident</b>	<b>Non-Resident</b>
Adult (18 & over)	\$150.00/yr	\$150.00/yr
Youth <sup>1</sup> (13 to 17)	\$150.00/yr	\$150.00/yr
Seniors/Disabled/Veterans (60 & over)	\$75.00/yr	\$75.00/yr
Seniors (60 & over) (from 9:00 AM – 12:00 PM, Mon. thru Fri. only)	Free	Free
Guest Rate	\$5.00/day	\$5.00/day
Family (up to 2 members)	\$188/yr	\$188/yr
Family (up to 3 members)	\$263/yr	\$263/yr
Additional Family Members (in excess of 3 members)	\$75/yr	\$75/yr
<b>2. OPEN GYM ACTIVITY</b>		
	<b>Rates</b>	
	<b>Resident</b>	<b>Non-Resident</b>
Adult (18 & over)	\$4.00/day	\$4.00/day
Youth <sup>1</sup> (17 & under)	Free	Free
<b>3. GYMNASIUM MEMBERSHIP</b>		
	<b>Rates</b>	
	<b>Resident</b>	<b>Non-Resident</b>
Adult (18 & over)	\$150.00/yr	\$150.00/yr
Seniors/Disabled/Veterans (60 & over)	\$75.00/yr	\$75.00/yr
Seniors (60 & over) (from 9:00 AM – 12:00 PM, Mon. thru Fri. only)	Free	Free
<b>4. POOL MEMBERSHIP<sup>2</sup></b>		
	<b>Rates</b>	
	<b>Resident</b>	<b>Non-Resident</b>
Adult (18 & over)	\$90.00/yr	\$150.00/yr
Youth <sup>1</sup> (17 & under)	\$50.00/yr	\$100.00/yr
Seniors/Disabled/Veterans (60 & over)	\$50.00/yr	\$100.00/yr
Family (up to 4 members)	\$250.00/yr	\$350.00/yr
Additional Family Members (in excess of 4 members)	\$40.00/yr	\$70.00/yr
Seniors (60 & over) (from 9:00 AM – 12:00 PM, Mon. thru Fri. only)	Free	
<b>5. RECREATION MEMBERSHIP<sup>3</sup></b>		
	<b>Rates</b>	
	<b>Resident</b>	<b>Non-Resident</b>
Adult (18 & older)	\$340.00/yr	\$340.00/yr
Youth <sup>1</sup> (13 to 17)	\$190.00/yr	\$190.00/yr
Seniors/Disabled/Veterans (60 & over)	\$170.00/yr	\$170.00/yr

<sup>1</sup> Parent/Guardian supervision is required for all youth under age 18

<sup>2</sup> Pool membership includes amenities at the discounted, private rental rate

<sup>3</sup> Recreation membership includes complete access to pool, fitness room, and open gym

<b>6. POOL FEES<sup>4</sup></b>	<b>Rates</b>	
	<b>Resident</b>	<b>Non-Resident</b>
<b>General Pool Admission</b>		
Adult (18 & over)	\$5.00	\$10.00
Seniors/Disabled/Veterans/Youth (17 & under)	\$3.00	\$5.00
Seniors (60 & over)(from 9:00 AM – 12:00 PM, Mon. thru Fri. only)	Free	\$5.00
<b>Lessons</b>	<b>Resident</b>	<b>Non-Resident</b>
Tiny Tot Lessons ( <del>6 months</del> <u>1 year</u> to 5 years)	\$50.00	\$60.00
Child Lessons (6 years & over)	\$50.00	\$60.00
Private Swimming Lessons (per hour)	\$75.00	\$100.00
<b>Pool Rental – Pool</b>	<b>Resident</b>	<b>Non-Resident</b>
Lane Rental <sup>5</sup> (Maximum of 6 participants)	\$15.00	\$30.00
Outside Clubs/Organizations (Team Usage)	Negotiated	Negotiated
Red Cross Certification Courses	Negotiated	Negotiated
Swim Meets	Negotiated	Negotiated
Senior High Schools (e.g., Swim Teams/Water Polo)	\$1,500.00/Season	\$1,500.00/Season
Middle Schools (e.g., Swim Teams/Water Polo)	\$200.00/Monthly	\$200.00/Monthly
<b>Pool Rental – Pool – Private<sup>6</sup></b>	<b>Resident</b>	<b>Non-Resident</b>
4-Hours	\$1,500.00	\$2,000.00
Additional Hour(s) (Up to 4 additional hours)	\$250.00/hr	\$400.00/hr
<b>Pool Rental – Multi-Purpose Room<sup>7</sup></b>	<b>Resident</b>	<b>Non-Resident</b>
4-Hours	\$320.00	\$400.00
Additional Hour(s) (Up to 4 additional hours)	\$100.00/hr	\$125.00/hr
Private Rental - 4-Hours	\$260.00/hr	\$320.00/hr
Private Rental - Additional Hour(s) (Up to 4 additional hours)	\$75.00	\$100.00
After-Hours Rental <sup>8</sup> (Up to 5 Hours)	\$2,000.00	\$2,500.00
After-Hours Rental Security Deposit <sup>4</sup>	\$500.00	\$500.00
<b>Pool Rental – 16 x 16 Shaded Space<sup>9</sup></b>	<b>Resident</b>	<b>Non-Resident</b>
4-Hours	\$100.00	\$150.00
Additional Hour(s) (Up to 4 additional hours)	\$20.00/hr	\$35.00/hr
Private Rental - 4-Hours	\$80.00/hr	\$120.00/hr
Private Rental - Additional Hour(s) (Up to 4 additional hours)	\$15.00/hr	\$25.00/hr
After-Hours Rental <sup>10</sup> (Up to 5 Hours)	\$80.00/hr	\$120.00/hr

<sup>4</sup> Return of security deposits is at the discretion of the City Manager and/or Recreation Director. The City Manager and/or Recreation Director may increase the amount of the security from \$100.00 up to \$500.00 depending on the event.

<sup>5</sup> Lane rentals do not include general pool admission

<sup>6</sup> Private pool rental includes use of the pool and designated pool chairs around the pool deck. Up to 75 participants are allowed in the pool at one time during rental. A security deposit may be required at the discretion of the City Manager and/or Recreation Director.

<sup>7</sup> Rentals of the pool multi-purpose room include tables and chairs for 50 people

<sup>8</sup> After-Hours Rentals are held after normal operating hours of the facility. The rental includes use of the multi-purpose room, catering room, and pool deck area. The maximum capacity for an after-hours rental is 150 people.

<sup>9</sup> General pool admission is waived for up to 8 participants with rental of the 16x16 shaded space

<sup>10</sup> After-Hours Rental of the 16x16 Shaded Space is available with the After-Hours Rental of the Multi-Purpose Room only. In addition, a Staff Fee is automatically applied for After-Hours Rentals of the 16x16 Shaded Space



<b>Pool Rental – 12 x 12 Umbrellas</b>	<b>Resident</b>	<b>Non-Resident</b>
4-Hours	\$25.00	\$50.00
Additional Hour(s) (Up to 4 additional hours)	\$15.00/hr	\$20.00/hr
<b>Staff Fee</b>	<b>Resident</b>	<b>Non-Resident</b>
	\$200.00	\$200.00
<b>7. CHILDREN’S PROGRAMS</b>	<b>Rates</b>	
<b>After School Program</b>	<b>Resident</b>	<b>Non-Resident</b>
Registration Fee	\$35.00	\$35.00
Daily Fee	\$8.00	\$8.00
Weekly Fee	\$35.00	\$35.00
After School Bus Only Weekly Fee (applies only to middle school)	\$10.00	\$10.00
<b>School Holiday Program</b>	<b>Resident</b>	<b>Non-Resident</b>
Registration Fee <sup>11</sup>	\$35.00	\$35.00
Daily	\$20.00	\$20.00
<b>Full Day Summer Camp</b>	<b>Resident</b>	<b>Non-Resident</b>
Registration Fee	\$50.00	\$50.00
Activity Fee (Field Trips/Special Events)	\$100.00	\$100.00
Weekly Fee (1 <sup>st</sup> Child)	\$100.00	\$100.00
Weekly Fee (Each Additional Child)	\$75.00	\$75.00
<b>8. FACILITY RENTAL FEES<sup>12</sup></b>	<b>Rates</b>	
<b>Multi-Purpose/Meeting Room</b>	<b>Non-Profit/Private Rental</b>	<b>For-Profit</b>
3-Hour Rental (Minimum)	\$150.00	\$225.00
Each Additional Hour	\$50.00/hr	\$100.00/hr
Security Deposit <sup>4</sup>	\$200.00	\$200.00
<b>Rebecca Sosa Theatre</b>	<b>Non-Profit/Private Rental</b>	<b>For-Profit</b>
Negotiated	Negotiated	Negotiated
<b>Prince Field - 10x10 Pavilion</b>	<b>Resident</b>	<b>Non-Resident</b>
3-Hour Rental (Minimum)	\$50.00	\$100.00
Each Additional Hour	\$15.00/hr	\$25.00/hr
Security Deposit <sup>4</sup>	\$100.00	\$100.00
<b>Field House<sup>13</sup></b>	<b>Resident</b>	<b>Non-Resident</b>
4-Hour Rental (Minimum)	\$250.00	\$500.00
Security Deposit <sup>4</sup>	\$100.00	\$100.00

<sup>11</sup> The School Holiday Registration Fee is waived for registered After School Program participants

<sup>12</sup> Residents of the Village of Virginia Gardens are provided a Resident rate for Facility Rentals

<sup>13</sup> ~~The Field House fees may be waived for City sponsored activities~~

<b>Basketball Gymnasium</b>	<b>Non-Profit/Private Rental</b>	<b>For-Profit</b>
Full Court	\$60.00/hr	\$100.00/hr
Half Court	\$30.00/hr	\$50.00/hr
<b>Volleyball Gymnasium</b>	<b>Non-Profit/Private Rental</b>	<b>For-Profit</b>
Full Court	\$30.00/hr	\$50.00/hr
<b>Complete Gymnasium (Wrestling/Judo)</b>	<b>Non-Profit/Private Rental</b>	<b>For-Profit</b>
Tournament (includes the whole gym for up to 4 hours)	\$500.00	\$750.00
Each Additional Hour	\$125.00/hr	\$175.00/hr
<b>Softball &amp; Baseball Field Rentals</b>	<b>Non-Profit/Private Rental</b>	<b>For-Profit</b>
Practice Fee (no field preparation required)	\$10.00	\$15.00
Game Rental (2-Hour minimum)	\$30.00	\$40.00
Each Additional Hour	\$15.00	\$20.00
Game Rental (2-Hour minimum) – With Lights	\$40.00	\$50.00
Each Additional Hour – With Lights	\$20.00	\$25.00
Lining Fee (Field prep, drag, & line)	\$35.00	\$35.00
<b>Soccer/Flag Football Field Rentals</b>	<b>Non-Profit/Private Rental</b>	<b>For-Profit</b>
Game Rental (2-Hour minimum)	\$35.00	\$45.00
Each Additional Hour	\$17.00	\$22.00
Game Rental (2-Hour minimum) – With Lights	\$45.00	\$55.00
Each Additional Hour – With Lights	\$22.00	\$28.00
Lining Fee (Field prep & line)	\$75.00	\$75.00
<b>Stafford Park - 20x20 Pavilion<sup>14</sup></b>	<b>Resident</b>	<b>Non-Resident</b>
3-Hour Rental (Minimum)	\$100.00	\$150.00
Each Additional Hour	\$30.00/hr	\$50.00/hr
Security Deposit <sup>4</sup>	\$100.00	\$100.00
<b>Batting Cages</b>	<b>Resident</b>	<b>Non-Resident</b>
Hourly Rental	\$15.00/hr	\$15.00/hr
Hourly Rental – With Lights	\$25.00/hr	\$25.00/hr
<b>Buses<sup>15</sup></b>	<b>Resident</b>	<b>Non-Resident</b>
Big Bus Hourly Rental (within Miami Springs/Virginia Gardens municipal limits)	\$75.00	\$75.00
Big Bus Hourly Rental (beyond Miami Springs/Virginia Gardens municipal limits)	\$100.00	\$100.00
Small Bus Hourly Rental (within Miami Springs/Virginia Gardens municipal limits)	\$50.00	\$50.00
Small Bus Hourly Rental (beyond Miami Springs/Virginia Gardens municipal limits)	\$75.00	\$75.00

<sup>14</sup> Stafford Park hours of operation are sunrise to sunset

<sup>15</sup> Rental is restricted to Miami-Dade County limits

<b>Fourth of July Parade<sup>16</sup></b>	<b>Resident</b>	<b>Non-Resident</b>
Spot in the parade	\$50.00	\$50.00
<b>Circle/Gazebo Pavilion<sup>17</sup></b>	<b>Resident</b>	<b>Non-Resident</b>
3-Hour Rental (Minimum)	\$750.00	\$750.00
Each Additional Hour	\$150.00/hr	\$150.00/hr
Security Deposit <sup>4</sup>	\$100.00 - \$500.00	\$100.00 - \$500.00
<b>Curtiss Parkway or Westward Drive Median Rental</b>	<b>Resident</b>	<b>Non-Resident</b>
3-Hour Rental (Minimum)	\$300.00	\$300.00
Each Additional Hour	\$75.00/hr	\$75.00/hr
Security Deposit <sup>4</sup>	\$100.00 - \$500.00	\$100.00 - \$500.00
<b>Special Event Application Fee</b>	<b>Resident</b>	<b>Non-Resident</b>
Application Fee	\$0	\$25.00
<b>Public Works Fees</b>	<b>Resident</b>	<b>Non-Resident</b>
Fee	\$50-\$500	\$50-\$500
<b>Police Department Fees</b>	<b>Resident</b>	<b>Non-Resident</b>
3-Hour Off-Duty Services (Minimum)	\$150.00	\$150.00
Each Additional Hour	\$50.00/hr	\$50.00/hr
<b>Table &amp; Chair Rentals</b>	<b>Resident</b>	<b>Non-Resident</b>
Set-up & Take-down (up to 5 tables & 50 chairs)	\$50.00	\$50.00
<b><u>9. Miami Springs Adult Community Center Facility</u></b>	<b><u>Rates</u></b>	
<b><u>Rental Fees</u></b>	<b><u>Resident</u></b>	<b><u>Non-Resident</u></b>
<b><u>Rebecca Sosa Dining Hall<sup>18</sup></u></b>	<b><u>\$400.00</u></b>	<b><u>\$550.00</u></b>
<b><u>4-Hour Rental</u></b>	<b><u>\$100.00</u></b>	<b><u>\$140.00</u></b>
<b><u>Each Additional Hour</u></b>	<b><u>Varies</u></b>	<b><u>Varies</u></b>
<b><u>Security Deposit<sup>19</sup></u></b>	<b><u>\$900.00</u></b>	<b><u>\$1,150.00</u></b>
<b><u>After-Hours Rental<sup>20</sup></u></b>	<b><u>\$500</u></b>	<b><u>\$500</u></b>
<b><u>After-Hours Security Deposit</u></b>		

<sup>16</sup> Non-profit organizations are exempt from the fee upon proof of non-profit/tax-exempt status

<sup>17</sup> Additional fees for Police and Public Works will be added depending upon the amount of staff and services needed. Payment of Police and Public Works fees will be required prior to the event date.

<sup>18</sup> Tables and Chairs for 75 people included in Rental Fee. Additional tables and chairs will be the responsibility of the party renting the facility. The Multi-Purpose room has a max of (6) hours per rental.

<sup>19</sup> Pricing of Security Deposit will be at discretion of City Manager and/or Recreation Director.

<sup>20</sup> After-Hours rental applies to rentals held after normal operating hours. After-hours rental price includes: 2 Staff members (an average rate of \$10/hr/employee); Rebeca Sosa Dining Hall Rate (\$400.00); Additional Hour Fee (\$100.00); Catering Area (\$80.00); Outside Patio (\$240.00); and use of the MPR. Rates reflected are resident rates. Return of security deposit is at the discretion of City Manager and/or Recreation Director. After--hours rentals have a max of five hours per rental. Maximum Capacity is 100. After-hours rentals are allowed to stay until 11:00 PM on Fridays and Saturdays. All guests and staff must be out of the building by 11:00 PM.

<b>Outside Patio<sup>21</sup></b>	<b>Resident</b>	<b>Non-Resident</b>
<u>4-Hour Rental</u>	<u>\$240.00</u>	<u>\$300.00</u>
<u>Each Additional Hour</u>	<u>\$60.00</u>	<u>\$75.00</u>
<u>Security Deposit</u>	<u>\$100.00</u>	<u>\$100.00</u>
<b>Classroom<sup>22</sup></b>	<b>Resident</b>	<b>Non-Resident</b>
<u>Per Hour</u>	<u>\$30.00</u>	<u>\$50.00</u>
<b>Art Room<sup>23</sup></b>	<b>Resident</b>	<b>Non-Resident</b>
<u>Per Hour</u>	<u>\$40.00</u>	<u>\$80.00</u>
<b>9.10. CITY EMPLOYEES &amp; COUNCILMEMBERS</b>		
<p>Full-time City employees, City Councilmembers, and their immediate family and grandchildren under age 25 are eligible for the following:</p> <ul style="list-style-type: none"> <li>a) Complimentary general admission to pool, gym, and fitness room</li> <li>b) A 50% discount on summer programs and special events operated by the Recreation Department (Note: No discount is available for programs operated by other organizations such as the Optimist, Little League, etc.)</li> </ul>		
<b>10.11. SPECIAL CONTRACTUAL ACTIVITIES</b>		
<p>These activities will be offered as available and appropriate fees will be charged. Additional information may be obtained from the Recreation Office.</p>		
<b>11.12. SPECIAL CONDITIONS, REQUIREMENTS &amp; RATES</b>		
<ul style="list-style-type: none"> <li>a) There is no rental or private use of the Prince Field Tot Lot</li> <li>b) Security deposits will be returned at the discretion of the City Manager and/or Recreation Director</li> <li>c) Jump houses are permitted so long as City-approved vendors are used and proof of insurance naming the City of Miami Springs as an additional insured is provided</li> <li>d) Memberships in excess of \$150.00 annually may be paid in two payments</li> <li>e) All City of Miami Springs employees, their spouses, and their immediate family (i.e., children) under the age of 25 are eligible for resident fees upon presentation of proof satisfactory to the cashier</li> <li>f) All City of Miami Springs property and/or business owners and their immediate family (i.e., children) under the age of 25 are eligible for resident fees upon presentation of proof satisfactory to the cashier</li> </ul>		

<sup>21</sup> Includes access to the playground and use of the bathroom. The Outside Patio has a max of six hours per rental.

<sup>22</sup> Tables and Chairs for set up as they are is included in Rental Fee. The Classroom has a max of (6) hours per rental. Max Capacity of 15. Pricing of Security Deposit will be at discretion of City Manager and/or Recreation Director.

<sup>23</sup> Tables and Chairs for set up as they are is included in Rental Fee. The Classroom has a max of (6) hours per rental. Max Capacity of 20. Pricing of Security Deposit will be at discretion of City Manager and/or Recreation Director.



# AGENDA MEMORANDUM

**Meeting Date:** 6/28/2021

**To:** The Honorable Mayor Maria Puente Mitchell and Members of the City Council

**Via:** William Alonso, City Manager/Fin. Director

**From:** Omar L. Luna, Recreation Director

**Subject:** Aquatic Center Cabanas

**RECOMMENDATION:**

Recommendation by Recreation Department that Council approve an expenditure in an amount not to exceed \$14,400.00, to American Awning Services, Inc, the lowest responsible quote after obtaining three written quotes (attached) to replace the 6 cabana covers at the pool, pursuant to Section §31.11 (C)(2) of the City Code.

**DISCUSSION:**

This project was supposed to be budgeted for next Fiscal Year 21/22. However, due to the fact that the cabanas are an eyesore and we have also lost some revenues due to patrons not renting out cabanas, we would recommend doing this project this fiscal year. We will be selecting a royal blue color that will match the large shade canopy and also that fumbrella by the beach area that have outlasted the white cabana material. This new fabric comes with a five-year warranty. We will keep the structures and only replace the fabric instead of spending \$80-\$100K for a total replacement of structure and fabric. Funding will come from available general fund balance.

**Submission Date and Time:** 6/22/2021 2:35 PM

<u>Submitted by:</u>	<u>Approved by (sign as applicable):</u>	<u>Funding:</u>
Department: <u>Recreation</u>	Dept. Head: <u></u>	Dept./ Desc.: _____
Prepared by: <u>Omar Luna</u>	Procurement: _____	Account No.: _____
Attachments: <input checked="" type="checkbox"/> Yes <input type="checkbox"/> No	Asst. City Mgr.: _____	Additional Funding: _____
Budgeted/ Funded: <input type="checkbox"/> Yes <input checked="" type="checkbox"/> No	City Manager: _____	Amount previously approved: \$ _____
		Current request: \$ _____
		Total vendor amount: \$ _____

**RESOLUTION NO. 2021-\_\_\_\_**

**A RESOLUTION OF THE MAYOR AND CITY COUNCIL OF THE CITY OF MIAMI SPRINGS, FLORIDA, APPROVING THE PURCHASE OF CABANA COVERS FOR THE CITY'S AQUATIC CENTER FROM AMERICAN AWNING SERVICES, INC. IN AN AMOUNT NOT TO EXCEED \$14,400; PROVIDING FOR AUTHORIZATION; AND PROVIDING FOR AN EFFECTIVE DATE.**

**WHEREAS**, the City of Miami Springs (the "City") seeks to replace six cabana covers at the Aquatic Center (the "Equipment"); and

**WHEREAS**, in accordance with Section 31-11(c)(2) of the City's Code of Ordinances (the "Code"), the City requested three quotes to purchase and install the Equipment, anticipating that the good faith estimate total cost would not exceed \$25,000; and

**WHEREAS**, American Awning Services, Inc. (the "Contractor") submitted a quote totaling \$14,400 for the Equipment, a copy of which is attached hereto as Exhibit "A" (the "Quote"); and

**WHEREAS**, pursuant to the procurement process and the recommendation of the City Manager, the City Council desires to approve the purchase of the Equipment from the Contractor consistent with the Quote in an amount not to exceed \$14,400 pursuant to Section 31-11(c)(2) of the City Code; and

**WHEREAS**, the City Council finds that this Resolution is in the best interest and welfare of the residents of the City.

**NOW, THEREFORE, BE IT RESOLVED BY THE MAYOR AND CITY COUNCIL OF THE CITY OF MIAMI SPRINGS, FLORIDA, AS FOLLOWS:**

**Section 1. Recitals.** That the above recitals are confirmed, adopted, and incorporated herein and made a part hereof by reference.

**Section 2. Approval.** That the City Council hereby approves the purchase of the Equipment pursuant to Section 31-11(c)(2) of the City Code.

**Section 3. Authorization.** That the City Council hereby authorizes the City Manager to purchase the Equipment from the Contractor consistent with the terms and

conditions of the Quote attached hereto as Exhibit "A," and to expend budgeted funds in an amount not to exceed \$14,400.

**Section 4. Effective Date.** That this Resolution shall be effective immediately upon adoption.

The foregoing Resolution was offered by \_\_\_\_\_ who moved its adoption. The motion was seconded by \_\_\_\_\_ and upon being put to a vote, the vote was as follows:

Vice Mayor Bob Best	_____
Councilwoman Jacky Bravo	_____
Councilwoman Dr. Walter Fajet	_____
Councilman Dr. Victor Vazquez	_____
Mayor Maria Puente Mitchell	_____

PASSED AND ADOPTED this 28<sup>th</sup> day of June, 2021.

ATTEST:

\_\_\_\_\_  
MARIA PUENTE MITCHELL  
MAYOR

\_\_\_\_\_  
ERIKA GONZALEZ, MMC  
CITY CLERK

APPROVED AS TO FORM AND LEGAL SUFFICIENCY  
FOR THE USE AND RELIANCE OF THE CITY OF MIAMI SPRINGS ONLY:

\_\_\_\_\_  
WEISS SEROTA HELFMAN COLE & BIERMAN, P.L.  
CITY ATTORNEY



"High Quality Guaranteed"

10890 Quail Roost Drive #32 Miami, FL. 33157

Email: americanawningservices@gmail.com

f Americanawningservices

G-page/americanawningservicesmiami

www.AWNINGSINMIAMI.com www.TOLDOSEINMIAMI.com

LICENSED & INSURED  
LIC#13BS00325

Cell: 786-991-7591

Off: 786-868-6561

- Toldos
- Canvas & Vinyl
- Carports
- Terrace
- Canopies
- Retractable
- Cabanas
- Shades
- Aluminum Patio

- ESTIMATE/PROPOSAL  
 INVOICE

DATE	06-19-21
ORDER No	

**BRAID COLOR**

**DESIGN TYPE**

- 
- 
- 
- 
- 
- 
- OTHER Tiedback

**FRAME DESCRIPTION**

- Galvanized M
- Aluminum
- Schedule 40
- Paint Color N/A

**FABRIC DESCRIPTION**

- \* Sumbrella Finesist
- Weblon \_\_\_\_\_
- Calabana \_\_\_\_\_
- \* Patio Shade cloth
- Ferrari \_\_\_\_\_
- Binder Color \_\_\_\_\_

with payments to be as follows

Deposit	\$	_____
Date		_____
Balance Due on Delivery	\$	_____
Date		_____
Tax	\$	_____
Total	\$	_____

Customer Name: MIAMI SPRINGS AQUATIC CENTER

Address: 1401 WESTWARD DRIVE

City, State, Zip Code: MIAMI SPRINGS, FL 33166  
305-805-5078

Phone No: 305-491-8957-Keem Email: DEANJ@MiamiSprings-FL.gov

**JOB DESCRIPTION**

- ⑥ CABANA AWNING RECOVER FOR AN EXISTING FRAME.
- A . 15'-6" x 15'-6" = \$ 14,400 (SUMBRELLA FINEST)
- B . 15'-6" x 15'-6" = \$ 13,200 (SHADE FABRIC)

- Sumbrella FINEST FABRIC WITH 5 YEARS WARRANTY FROM MANUFACTURERS.
- HIGH Quality guaranteed
- 4-5 weeks installation.

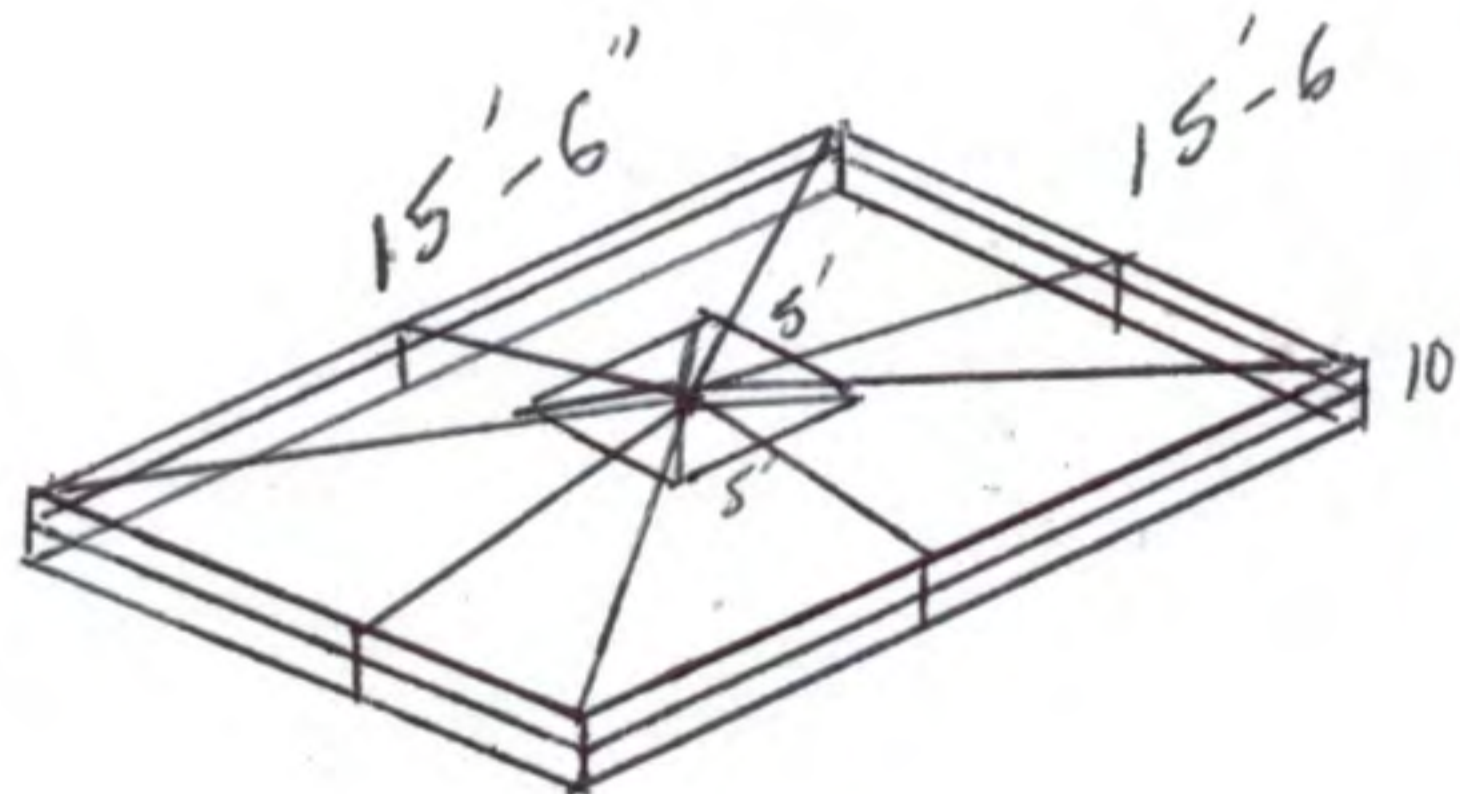

A 50% deposit is required to begin a work and the balance is due when the job is installed on installation day. The Materials are guaranteed to be in accordance with the specifications, and the drawings provided, and to be completed in a dependable manner for the sum of:

\_\_\_\_\_  
Sales Representative Signature

NOTE: This proposal maybe withdrawn by us if not accepted with \_\_\_\_\_ days

**ACCEPTANCE OF PROPOSAL**

The conditions and prices described above are satisfactory and accepted. You are authorized to perform the job in accordance with the specifications. Payments will be made as described above. Terms & conditions, see on back of this proposal/Invoice

DATE: \_\_\_\_\_

Permitted by Customer

Customer Signature: \_\_\_\_\_

Installed By: \_\_\_\_\_

Customer Initials: \_\_\_\_\_



Since 1919



"Between you and the Sun"

3905 N.W. 31st AVENUE \* MIAMI, FL 33142  
 DADE: (305) 576-2029 \* FAX: (305) 576-0514  
 E-MAIL: fsanchez@miamiawning.com

Lic. No. SCC1311552214

PROPOSAL / AGREEMENT

Date: 5/19/2021

<b>Fabric Number</b> POLYFAB COMTEX	<b>Color</b> N/A
<b>VALANCE</b> N/A	<b>Length</b> N/A
<b>Binding Color</b> N/A	<b>Thread Color</b> POLY
<b>Applique</b> N/A	<b>Color</b> N/A
<b>Frame</b> EXISTING AS IS	<b>Color</b> EXISTING AS IS
<b>SIZING OF AWNING</b>	
<b>WIDTH</b>	<b>HEIGHT</b>
15'-0"	2'-8"
<b>PROJECTION</b>	
15'-0"	

<b>Name</b> CITY OF MIAMI SPRINGS AQUATIC PARK		
<b>Job Site Address</b> 1401 WESWARD DRIVE		<b>Job Site Phone Number</b>
<b>City</b> MIAMI SPRINGS, FL	<b>Zip Code</b> 33166	<b>Cell Phone Number</b> 305-805-5078
<b>Invoice Name (If Diff)</b>		<b>Phone Number</b>
<b>Invoice Address (If Diff)</b>		<b>Fax - Number</b>

Units	DESCRIPTION	PRICE
6	FABRIC RECOVER ONLY FOR STATIONARY CABANAS AT AQUATIC CENTER POOL DECK PATTERN POLYFAB COMTEX EXTRA HEAVY DUTY KNITTED SHADE CLOTH WITH A TEN YEARS LIMITED WARRANTY. SEE ATTACHED BROCHURE SPECIFICATIONS FABRIC RECOVER ONLY FOR FRAME TOP BANNER AND CUPULA.	
	TOTAL INSTALLED PRICE	\$16,838.00
	IN ADDITION TO THE CONTRACT PRICE, CUSTOMER SHALL BE RESPONSIBLE FOR THE ACTUAL PERMITTING EXPENSES, WHEN APPLICABLE	

<b>TERMS OF PAYMENT</b>		<b>TOTAL</b>	<b>\$16,838.00</b>
	1/2 DEPOSIT REQUIRED WITH ORDER	<b>DEPOSIT</b>	<b>\$8,419.00</b>
	BALANCE TO BE PAID UPON INSTALLATION.	<b>BALANCE</b>	<b>\$8,419.00</b>

PROPOSED: MIAMI BEACH AWNING CO., INC.  
 D/B/A MIAMI AWNING CO.

ACCEPTED SUBJECT TO THE TERMS AND CONDITIONS  
 ABOVE AND ON REVERSE SIDE OF THIS PROPOSAL

Frank Sanchez  
 Sales Representative

Buyer or Buyer's Agent

Date: \_\_\_\_\_

Date: \_\_\_\_\_

Since 1919



"Between you and the Sun"

3905 N.W. 31st AVENUE \* MIAMI, FL 33142  
 DADE: (305) 576-2029 \* FAX: (305) 576-0514  
 E-MAIL: fsanchez@miamiawning.com

Lic. No. SCC1311552214

PROPOSAL / AGREEMENT

Date: 5/19/2021

<b>Fabric Number</b> FIRESIST	<b>Color</b>
<b>VALANCE</b> N/A	<b>Length</b> N/A
<b>Binding Color</b> N/A	<b>Thread Color</b> POLY
<b>Applique</b> N/A	<b>Color</b> N/A
<b>Frame</b> EXISTING AS IS	<b>Color</b> EXISTING AS IS

<b>Name</b> CITY OF MIAMI SPRINGS AQUATIC PARK		
<b>Job Site Address</b> 1401 WESWARD DRIVE		<b>Job Site Phone Number</b>
<b>City</b> MIAMI SPRINGS, FL	<b>Zip Code</b> 33166	<b>Cell Phone Number</b> 305-805-5078
<b>Invoice Name (If Diff)</b>		<b>Phone Number</b>
<b>Invoice Address (If Diff)</b>	<b>Zip Code</b>	<b>Fax - Number</b>

SIZING OF AWNING		
WIDTH	HEIGHT	PROJECTION
15'-0"	2'-8"	15'-0"

Units	DESCRIPTION	PRICE
6	FABRIC RECOVER ONLY FOR STATIONARY CABANAS AT AQUATIC CENTER POOL DECK PATTERN FIRESIST PLAIN WEAVE SOLUTION DYED FABRIC WITH A FIVE YEARS LIMITED WARRANTY SEE ATTACHED BROCHURE SPECIFICATIONS FABRIC RECOVER ONLY FOR FRAME TOP BANNER AND CUPULA.  TOTAL INSTALLED PRICE	\$18,128.00
IN ADDITION TO THE CONTRACT PRICE, CUSTOMER SHALL BE RESPONSIBLE FOR THE ACTUAL PERMITTING EXPENSES, WHEN APPLICABLE		

<b>TERMS OF PAYMENT</b>		<b>TOTAL</b>	<b>\$18,128.00</b>
	<b>1/2 DEPOSIT REQUIRED WITH ORDER</b>	<b>DEPOSIT</b>	<b>\$9,064.00</b>
	<b>BALANCE TO BE PAID UPON INSTALLATION.</b>	<b>BALANCE</b>	<b>\$9,064.00</b>

PROPOSED: MIAMI BEACH AWNING CO., INC.  
 D/B/A MIAMI AWNING CO.

ACCEPTED SUBJECT TO THE TERMS AND CONDITIONS  
 ABOVE AND ON REVERSE SIDE OF THIS PROPOSAL

Frank Sanchez  
 Sales Representative

Buyer or Buyer's Agent

Date: \_\_\_\_\_

Date: \_\_\_\_\_

Begin forwarded message:

**From:** Mitch Leitner <[mitch@superiorparksystems.com](mailto:mitch@superiorparksystems.com)>  
**Date:** June 22, 2021 at 2:49:58 PM EDT  
**To:** Omar Luna <[lunao@miamisprings-fl.gov](mailto:lunao@miamisprings-fl.gov)>  
**Subject:** Pool cabana shades

Hi Omar,

The (6) cabana shades to be replaced at the pool is going to be \$15,470.00 including custom manufacturing, freight and installation. Please let me know if you need any additional information.

Thank you,



**Mitch Leitner**

Owner, President | Superior Park  
Systems, Inc

m: 954-445-7000

e: [mitch@superiorparksystems.com](mailto:mitch@superiorparksystems.com)

1418 Scott Street  
Hollywood, FL 33020

[www.superiorparksystems.com](http://www.superiorparksystems.com)



# AGENDA MEMORANDUM

**Meeting Date:** 6/28/2021

**To:** The Honorable Mayor Maria Puente Mitchell and Members of the City Council

**Via:** William Alonso, City Manager/Fin. Director

**From:** Lazaro Garaboa, Public Works Director

**Subject:** East side fencing

**RECOMMENDATION:**

Recommendation by Public Works that Council approve an expenditure in an amount not to exceed \$21,042.00, to Guaranteed Fence Corp, the lowest responsible quote after obtaining three written quotes (attached) as funds will come from available general fund balance in the FY20/21 Budget pursuant to Section §31.11 (C)(2) of the City Code.

**DISCUSSION:**

Council approved during the meeting of June 14, 2021 the installation of 8 ft aluminum picket fencing on the following streets: Minola Dr., Mokena Dr, La Villa Dr, De Soto Dr, and De Leon Dr, in order to address residents' concerns regarding crime and other activities along the NW 36<sup>th</sup> St corridor. Council also requested that we obtain quotes for an 8 ft fence instead of the 6 ft fence originally proposed. The attached three quotes are all for 8 ft fencing.

Funding will come from available general fund balance.

**Submission Date and Time:** 6/24/2021 7:28 PM

<u>Submitted by:</u>	<u>Approved by (sign as applicable):</u>	<u>Funding:</u>
<b>Department:</b> <u>Public Works</u> <b>Prepared by</b> <u>Lazaro Garaboa</u> <b>Attachments:</b> <input checked="" type="checkbox"/> Yes <input type="checkbox"/> No <b>Budgeted/ Funded:</b> <input type="checkbox"/> Yes <input checked="" type="checkbox"/> No	<b>Dept. Head:</b> _____ <b>Procurement:</b> _____ <b>Asst. City Mgr.:</b> _____ <b>City Manager:</b> _____	<b>Dept./ Desc.:</b> _____ <b>Account No.:</b> _____ <b>Additional Funding:</b> _____ <b>Amount previously approved:</b> \$ _____ <b>Current request:</b> \$ <u>21,042.00</u> <b>Total vendor amount:</b> \$ <u>21,042.00</u>

**RESOLUTION NO. 2021-\_\_\_\_**

**A RESOLUTION OF THE MAYOR AND CITY COUNCIL OF THE CITY OF MIAMI SPRINGS, FLORIDA, APROVING THE PURCHASE AND INSTALLATION OF FENCE EQUIPMENT FROM GUARANTEED FENCE CORP. IN AN AMOUNT NOT TO EXCEED \$21,042 FOR THE EAST SIDE FENCING PROJECT; PROVIDING FOR AUTHORIZATION; AND PROVIDING FOR AN EFFECTIVE DATE.**

**WHEREAS**, the City of Miami Springs (the “City”) seeks to purchase and install eight-foot aluminum picket fences on Minola Drive, Mokena Driva, La Villa Drive, De Soto Drive, and De Leon Drive to address concerns related to crime and other activities occurring along the NW 36<sup>th</sup> Street corridor (the “East Side Fencing Project”); and

**WHEREAS**, in accordance with Section 31-11(c)(2) of the City’s Code of Ordinances (the “Code”), the City requested three quotes to purchase the Equipment, anticipating that the good faith estimate total cost would not exceed \$25,000; and

**WHEREAS**, Guaranteed Fence Corp. (the “Contractor”) submitted a quote totaling \$21,042 to provide the equipment and installation needed to execute the East Side Fencing Project, a copy of which is attached hereto as Exhibit “A” (the “Quote”); and

**WHEREAS**, pursuant to Section 31-11(c)(2) of the City Code and the recommendation of the City Manager, the City Council desires to approve the purchase of the equipment from the Contractor and authorize the Contractor to install the equipment to execute the East Side Fencing Project consistent with the Quote in an amount not to exceed \$21,042; and

**WHEREAS**, the City Council finds that this Resolution is in the best interest and welfare of the residents of the City.

**NOW, THEREFORE, BE IT RESOLVED BY THE MAYOR AND CITY COUNCIL OF THE CITY OF MIAMI SPRINGS, FLORIDA, AS FOLLOWS:**

**Section 1. Recitals.** That the above recitals are confirmed, adopted, and incorporated herein and made a part hereof by reference.

**Section 2. Approval.** That the City Council hereby approves the purchase of and installation of the equipment for the East Side Fencing Project pursuant to Section 31-11(c)(2) of the City Code.

**Section 3. Authorization.** That the City Council hereby authorizes the City Manager to execute the Quote attached hereto as Exhibit "A," and to expend budgeted funds in an amount not to exceed \$21,042.

**Section 4. Effective Date.** That this Resolution shall be effective immediately upon adoption.

The foregoing Resolution was offered by \_\_\_\_\_ who moved its adoption. The motion was seconded by \_\_\_\_\_ and upon being put to a vote, the vote was as follows:

Vice Mayor Bob Best	_____
Councilwoman Jacky Bravo	_____
Councilwoman Dr. Walter Fajet	_____
Councilman Dr. Victor Vazquez	_____
Mayor Maria Puente Mitchell	_____

PASSED AND ADOPTED this 28<sup>th</sup> day of June, 2021.

ATTEST:

\_\_\_\_\_  
MARIA PUENTE MITCHELL  
MAYOR

\_\_\_\_\_  
ERIKA GONZALEZ, MMC  
CITY CLERK

APPROVED AS TO FORM AND LEGAL SUFFICIENCY  
FOR THE USE AND RELIANCE OF THE CITY OF MIAMI SPRINGS ONLY:

\_\_\_\_\_  
WEISS SEROTA HELFMAN COLE & BIERMAN, P.L.  
CITY ATTORNEY

# GUARANTEED FENCE CORP

1091 E 26 ST  
BUILDING B  
HIALEAH FL 33013

## Estimate

Date	Estimate #
6/17/2021	122108

Name / Address
CITY OF MIAMI SPRINGS 345 N. ROYAL POINCIANA BLVD MIAMI SPRINGS, FL 33166

**FDOT DBE  
CERTIFIED**

P.O. No.	Terms
	DUE UPON JOB C...

Description	Qty	Rate	Total
ATTN: LIZ RE: PICKET FENCE - RESIDENTIAL AREA  FURNISH AND INSTALL APPROX 334' LF OF 8' HIGH ALUMINUM PICKET FENCE WITH 1" PICKETS, 2 1/2" LINE POSTS AT 6 O/C, (2) ROWS 1" X 2" RUNNERS *POWDER COATED COLOR TBD*  *PRICING IS ONLY VALID FOR 10 DAYS DUE TO RAPID AND UNSTABLE MATERIAL PRICING INCREASES  ANY QUESTIONS CALL TONY BULLA AT 786-486-4809	334	63.00	21,042.00
IF YOU DECIDE TO PROCEED WITH THE WORK PLEASE SIGN AND FAX BACK THE ESTIMATE.	<b>Total</b>		\$21,042.00

QUOTE IS VALID FOR 30 DAYS. IF YOU DECIDE TO PROCEED WITH THE WORK PLEASE SIGNED AND SEND BACK.

Signature \_\_\_\_\_

# Island Fence of Dade

711 E. Okeechobee Rd.  
 Hialeah, FL. 33010  
 Phone: (305) 888-9090  
 Fax: (305) 888-7424  
 www.islandfence.com



**Proposal - Contract**  
 Dade CC# 98-BS00247  
 Broward CC# 90-5718FX

Customers Name: <u>City of Miami Springs</u>		<u>Cló Lazaro</u>		Date: <u>6/23/2021</u>
Street: <u>201 Westward Dr.</u>		City: <u>Miami Springs</u>	State: <u>FL</u>	Zip: <u>33166</u>
Phone: <u>305.805.5030</u>	Cell Phone:	Fax:		
Email: <u>garaboa@miamisprings-fl.gov / FuentesL@</u>		Job Site Address:		

- Mokena  $12' \times 60' \times 5'$
- Minola  $5' \times 68' \times 1'$
- La Villa  $60'$
- De Soto  $63'$
- De Leon  $60'$

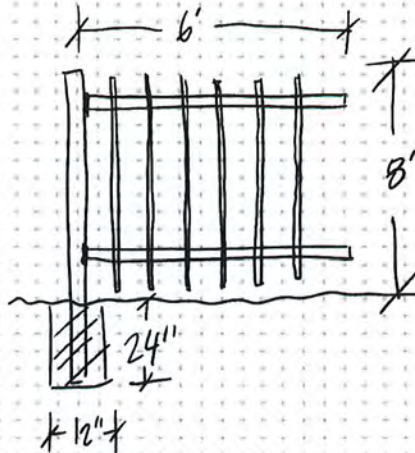

Notes: 334' x 8' Aluminum Picket Fence with Plastic caps.

Powder coated

1" x 1" pickets, 3" x 3" posts,

Price: \$25,200.00

\*Expediting Fee, Engineer Drawings with calculations if needed and Local Building Department Charges NOT INCLUDED\*

Customer's Signature: \_\_\_\_\_

Date: \_\_\_\_\_

Sales Rep: \_\_\_\_\_

Mark Lopez (786) 444-6560



## William Alonso

---

**From:** Lazaro M. Garaboa  
**Sent:** Wednesday, June 23, 2021 2:30 PM  
**To:** William Alonso  
**Cc:** Lizette Fuentes  
**Subject:** Fwd: Estimate lázaro

3rd quote

Lazaro Garaboa  
Public Works Director  
City of Miami Springs  
305 805-5170 X 4224

Begin forwarded message:

**From:** frankwelding@hotmail.com  
**Date:** June 23, 2021 at 2:28:06 PM EDT  
**To:** "Lazaro M. Garaboa" <garaboal@miamisprings-fl.gov>  
**Subject:** Estimate lázaro

334' Aluminun fance x 8'H poder coating green post  $2\frac{1}{2} \times 2\frac{1}{2} \times \frac{3}{16}$  . Piquet 1"× 1"× 0.93 material. Manufacturing.powder coating installation total \$42000

---

This email has been scanned for spam and viruses. Click [here](#) to report this email as spam.



**CITY OF MIAMI SPRINGS  
OFFICE OF THE CITY CLERK**  
201 Westward Drive  
Miami Springs, FL 33166-5259  
Phone: 305.805.5006  
Fax: 305.805.5028

**TO:** Honorable Mayor Mitchell and Members of the City Council  
**FROM:** Erika Gonzalez-Santamaria, MMC, City Clerk  
**VIA:** Juan D. Garcia, Deputy City Clerk  
**DATE:** June 28, 2021  
**SUBJECT: Board of Parks and Parkways Recommendation**

\*\*\*\*\*

At the meeting of March 10, 2020, the Board of Parks and Parkways recommended the following to Council:

3 – New Business:

a) Yard of the Month – April 2020

**By consensus, the Board agreed to recommend 189 Morningside Drive as the April 2020 Year of the Month.**

b) Yard of the Month – May 2020

**By consensus, the Board agreed to recommend 372 Minola Drive as the May 2020 Yard of the Month.**

c) Yard of the Month – June 2020

**By consensus, the Board agreed to recommend 920 Plover Avenue as the June 2020 Yard of the Month.**

\*Due to the Covid-19 pandemic, the Boards of Parks and Parkways' recommendation to nominate these properties for Yard of the Month was never brought before City Council for approval. At their last meeting on June 8, 2021, the Board of Parks and Parkways recommended to re-nominate the yards that were previously selected but never recognized. These nominations will be recognized for July, August, September 2021.